

Service Information.....	16 - 1	Starter relay switch.....	16 - 13
Troubleshooting.....	16 - 2	Clutch diode.....	16 - 14
Starter motor.....	16 - 5	Flywheel and starter clutch.....	16 - 14

- **Service Information**

- **General**



Always turn the ignition OFF when servicing the starter motor or relevant parts. Unexpected operation of the starter motor may cause injury.

- Refer to the troubleshooting chart for the starter inspection (16-2).
- Refer to 16-0 for the layout of the components.
- If it is difficult to/unable to start the engine, retry with a good (fully charged) battery to eliminate the possibility of weak battery power.
- Do not overcrank the engine when difficult to start. Excessive current to the starter motor may burn its coil.
- Refer to Sec. 17 for servicing the following items:
  - Side stand switch
  - Neutral switch
  - Main switch
  - Starter switch
  - Clutch switch

- **Specification**

Item	Standard	Service Limit
Starter motor brush length	12.5 ~ 13.0mm	8.5mm

- **Torque Settings**

Flywheel bolt	74N.m (7.5kgf-m) apply oil to the thread and the seat
One-way clutch socket bolt	16N.m (1.6kgf-m) apply screw locker

- **Special Tools**

Flywheel holder	07725-0030000
Flywheel puller	07733-0020001

• **Troubleshooting**

- Check the main fuse (20A) beforehand.
- Check the connections of battery/starter motor leads.
- If it is difficult to / unable to start, retry with a good (fully-charged) battery to eliminate the possibility of weak battery power.
- Prior to servicing the starter motor, turn the ignition ON and the kill switch RUN to check the side stand and the transmission gear are in startable position.
  - If the gear is in neutral, the starter motor operates regardless of the side stand switch/clutch switch positions.
  - If the gear is not in neutral, the starter motor operates under the following combination:

	Side stand	Clutch lever	Starter motor operation
Gear position (other than neutral)	Retracted	Held	Yes
		Released	No
	Extended	Held	No
		Released	No

• **Starter motor does not crank**

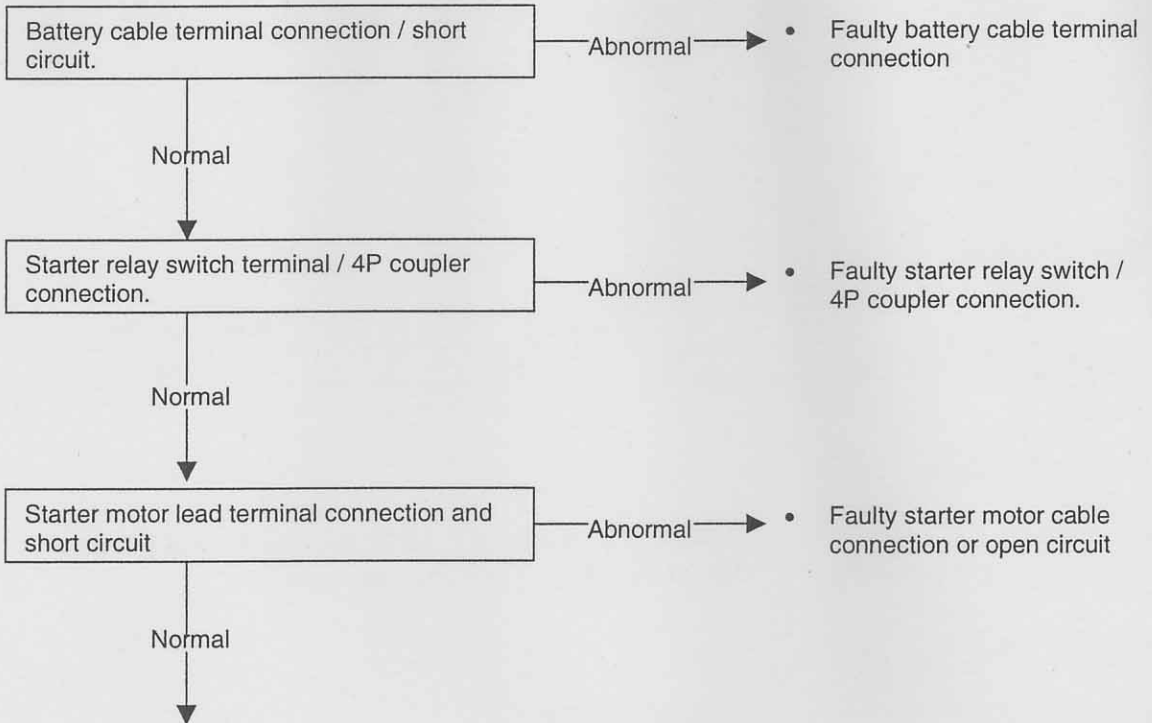

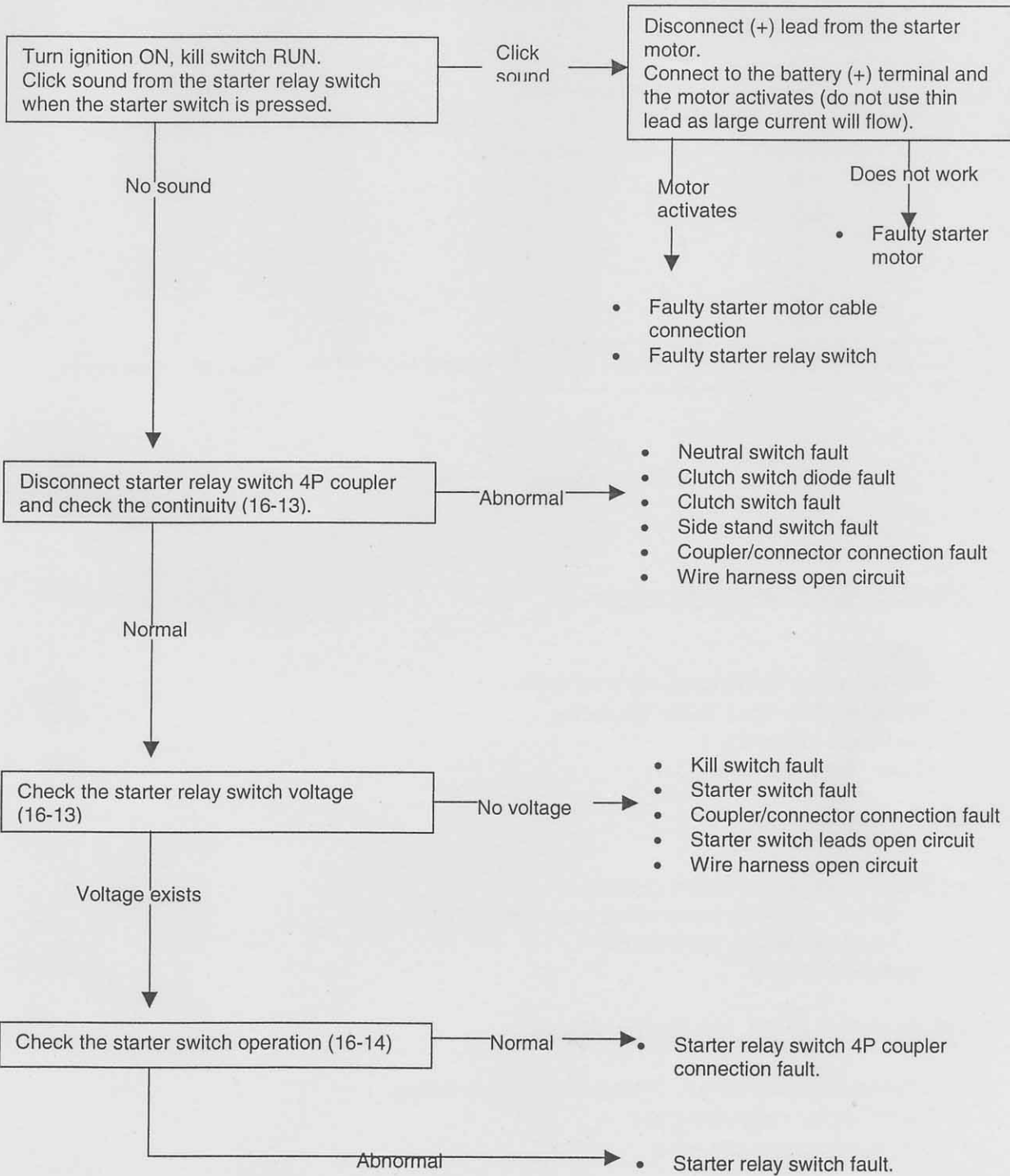

The starter motor works when the gear is in neutral. However, it does not work when the gear is not in neutral, the side stand is retracted and the clutch lever is held.

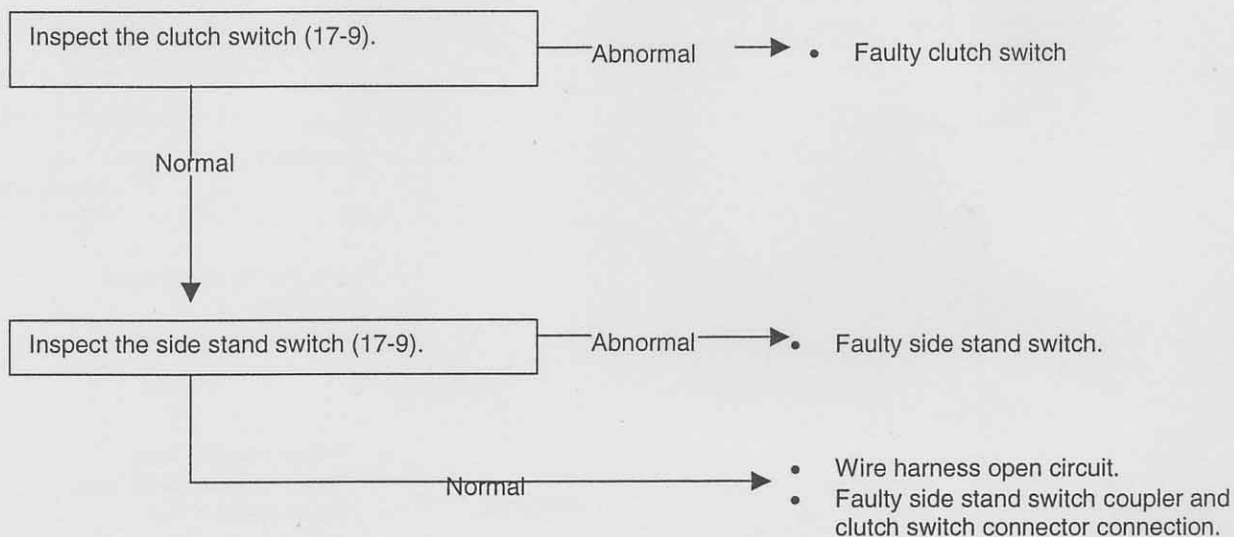

### Weak cranking (unable to crank)

- Battery flat
- Faulty battery terminal cable connection
- Faulty starter motor lead connection
- Faulty starter motor
- Brush worn/damaged

### Starter motor spins

- Motor running in reverse direction
  - Motor case was assembled in reverse direction
  - Leads reversely connected
- Starter clutch slip

### Starter motor is OK, but unable to crank

- Crankshaft does not turn because of engine failure
- Faulty starter reduction gear
- Damaged starter idle gear

- Starter Motor

- Removal

**Warning**

Always turn off the ignition when servicing the starter motor or relevant parts. Unexpected operation of the starter motor may cause injury.

Unscrew starter reduction gear cover bolts to remove a cover and an O-Ring.

Remove a gear shaft and a starter reduction gear.

Remove the following parts:

- Rubber cap
- Starter motor cable nut
- Starter motor cable
- Starter motor bolt
- Earth lead
- Starter lead

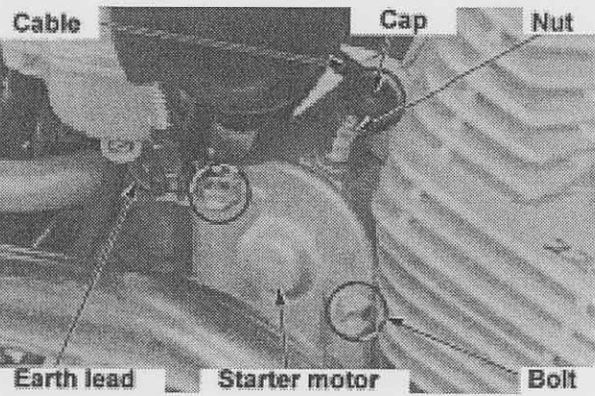
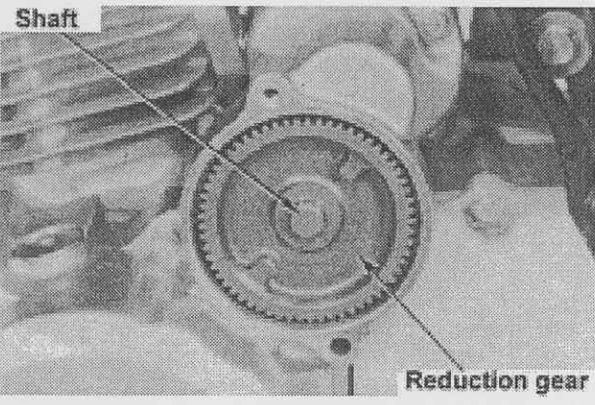
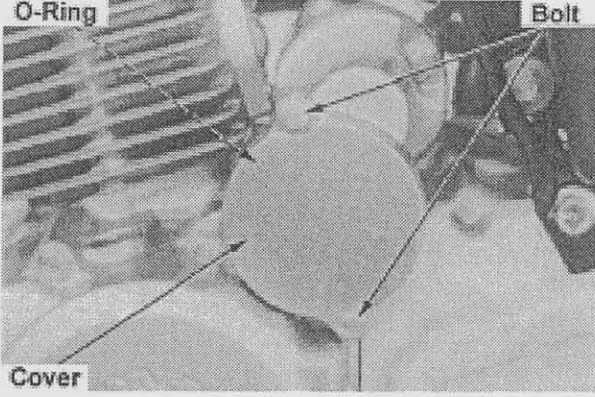

- O-Ring

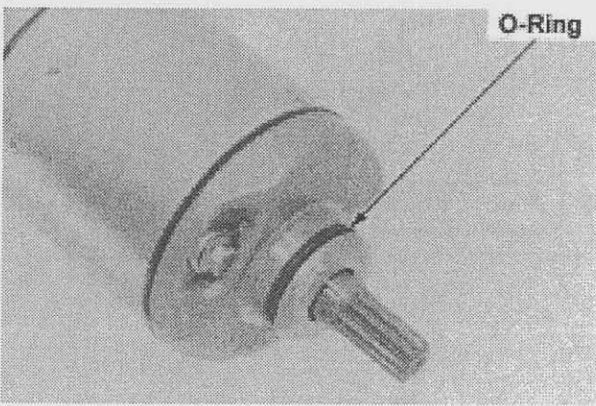

- **Disassembly**

Remove the following parts:

- Assembly bolt
- Plate
- O-Ring

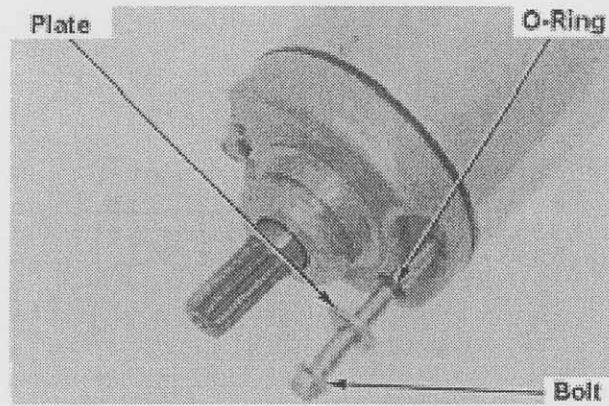

- Front cover
- O-Ring
- Lock washer

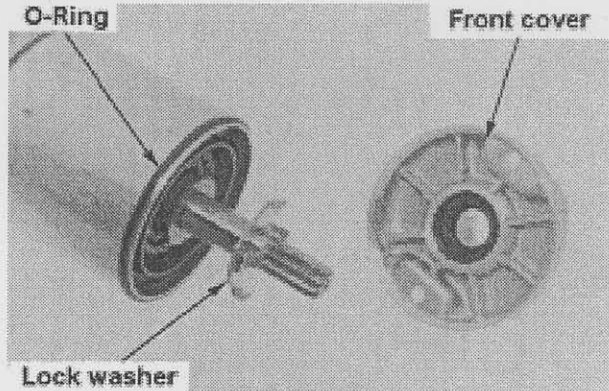

- Non-conductive washer
- Thrust washers

**Note:**  
Record the order and quantity of the thrust washers when disassembling.

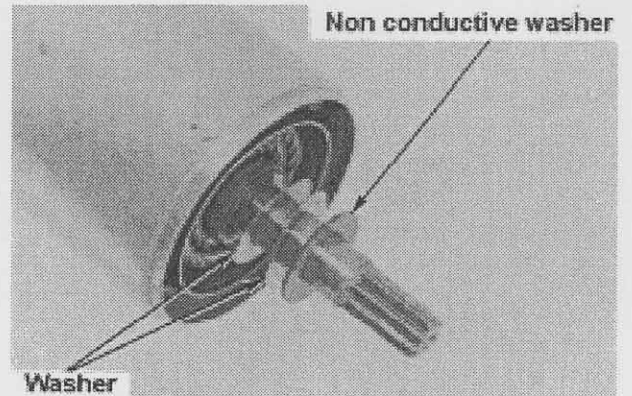

- Rear cover Assy
- O-Ring
- Thrust washers

**Note:**  
Record the order and quantity of the thrust washers when disassembling.

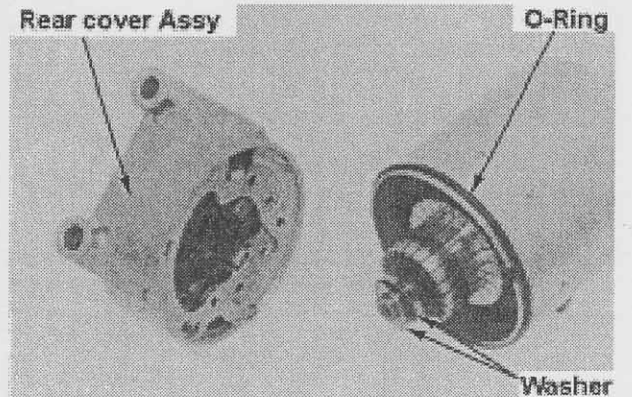

Remove the following parts:

- Armature
- Starter motor case

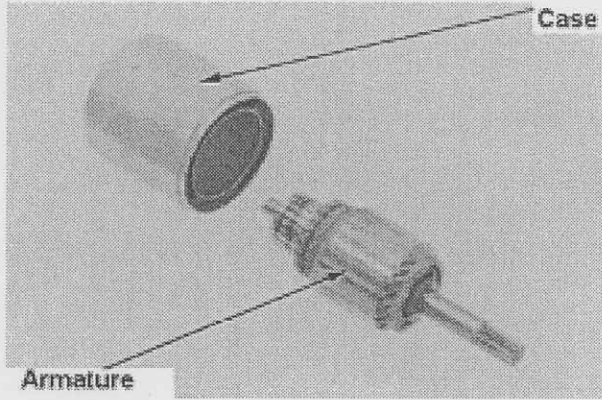

- Terminal nut
- Washer
- Non-conductive washer
- Shims
- O-Ring

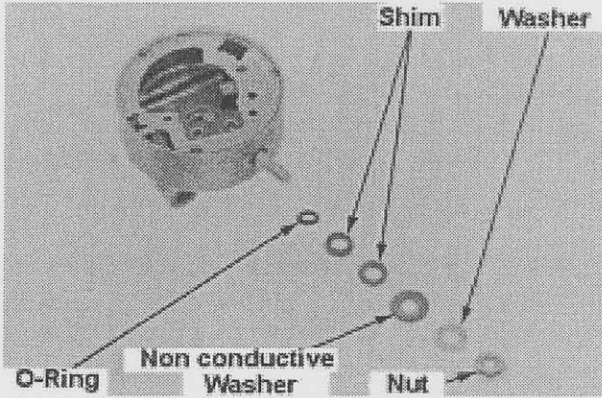

- Brush holder Assy
- Terminal bolt stopper
- Rear cover

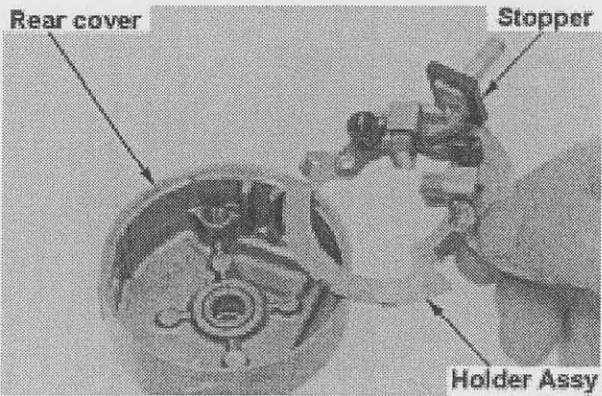

- Brush spring
- Terminal bolt
- Brush holder

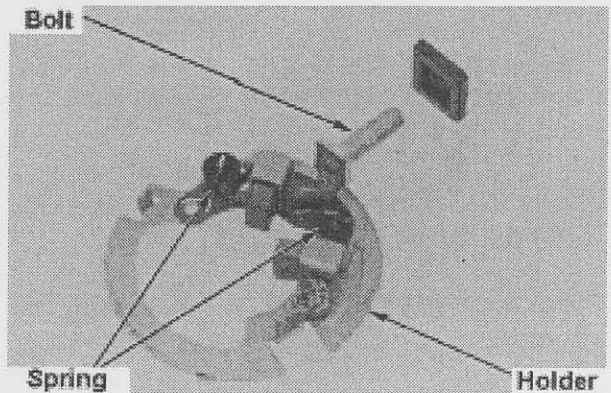



- **Inspection**

Armature inspection

Unequal wear / damage / burn on the commutator surface → replace.  
Clean metal particles between the segments.

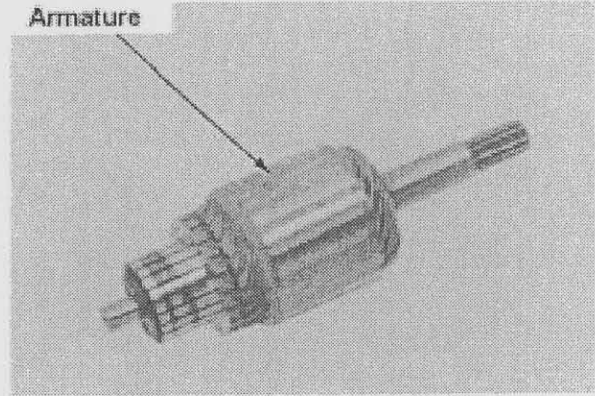

Check for continuity of the armature.  
Between each segment: continuity  
Between segments and the armature shaft: no continuity

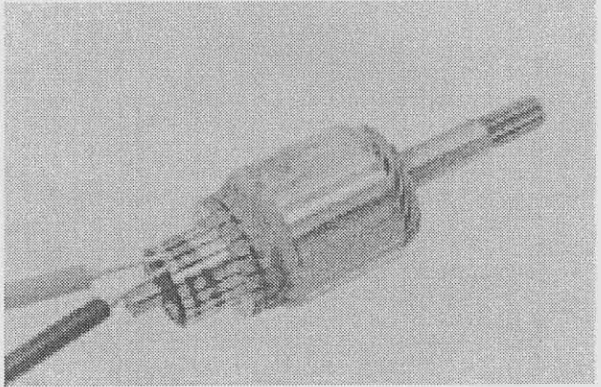

Replace the armature if the continuity was faulty.

Measure the brush length:

Service limit: 8.5mm or less → replace

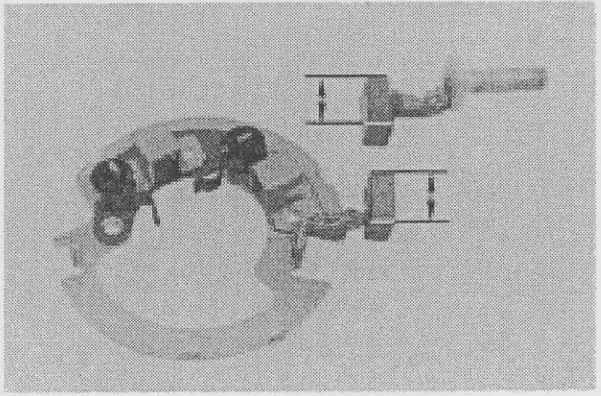

Check for continuity of the rear cover Assy.

Between the starter motor terminal and brush: continuity

Between the starter motor terminal and rear cover: no continuity

Replace parts if the continuity was faulty.

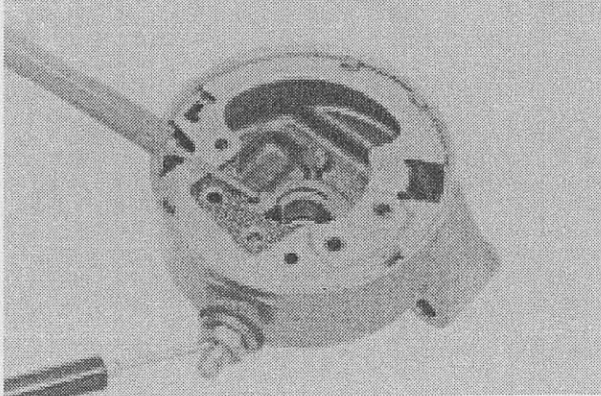

• Assembly

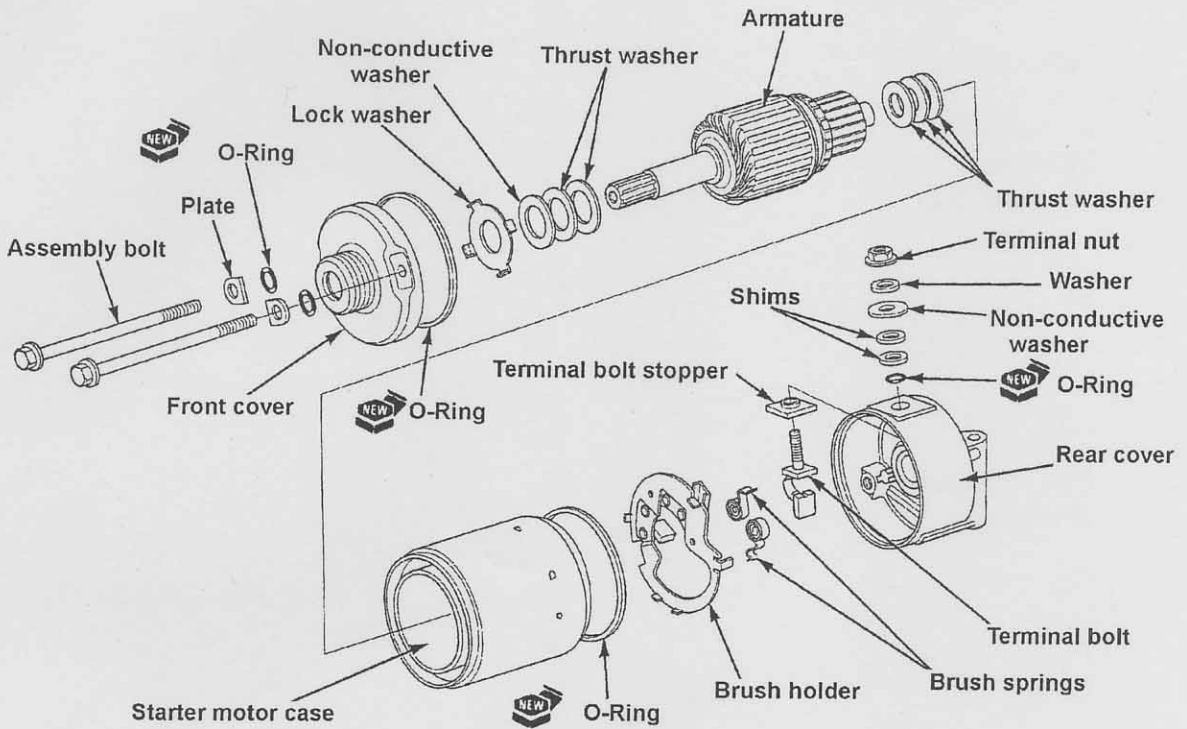

Install the following parts:

- Brush holder
- Terminal bolt
- Brush spring

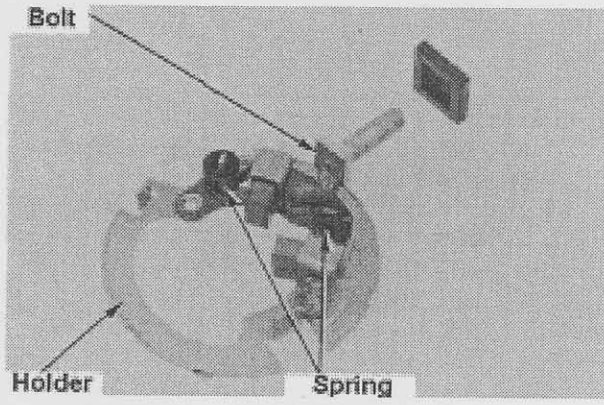

- Rear cover
- Terminal bolt stopper
- Brush holder Assy

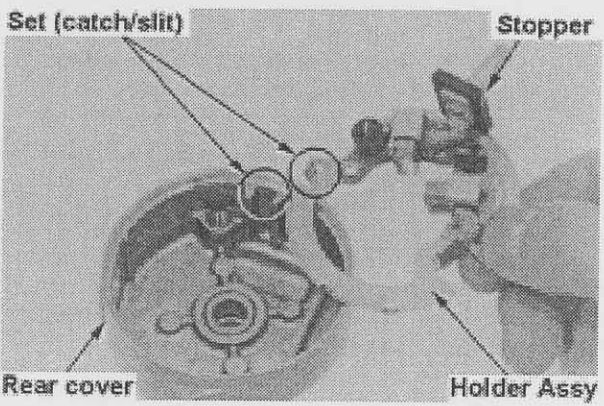

**Note:**  
Set the brush holder catch to the slit on the rear cover to install the holder.

Install the following parts:

- New O-Ring
- Shims
- Non-conductive washer
- Washer
- Terminal nut

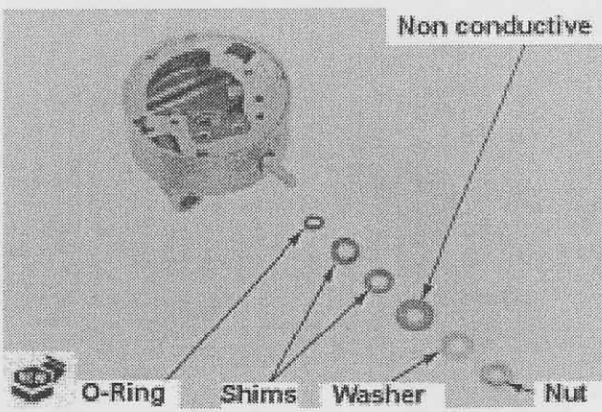

- Starter motor case
- Armature

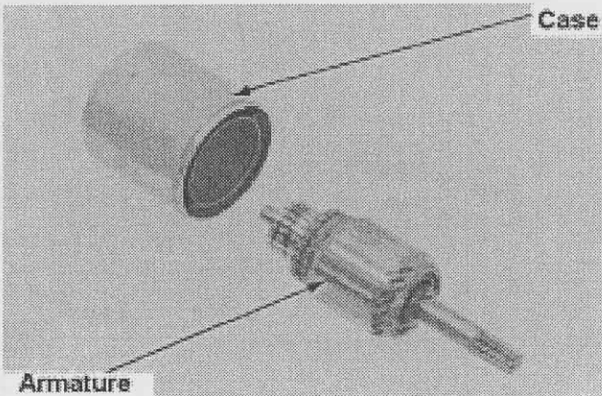

- Thrust washers

**Note:**  
Refer to your record on disassembly when installing thrust washers.

- New O-Ring
- Rear cover Assy

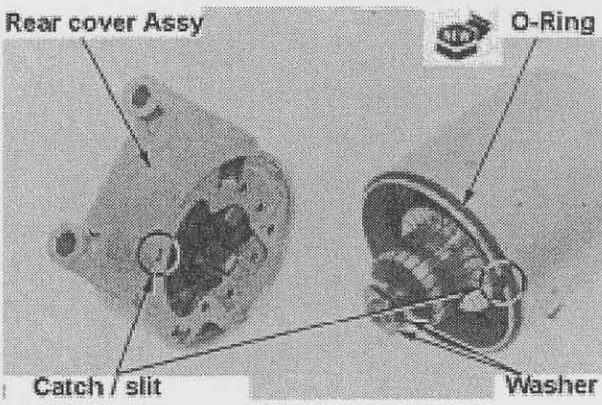

**Note:**  
Set the rear cover Assy catch to the motor case slit to install the cover Assy.

- Thrust washers

**Note:**  
Refer to your record on disassembly when installing thrust washers.

- Non – conductive washer

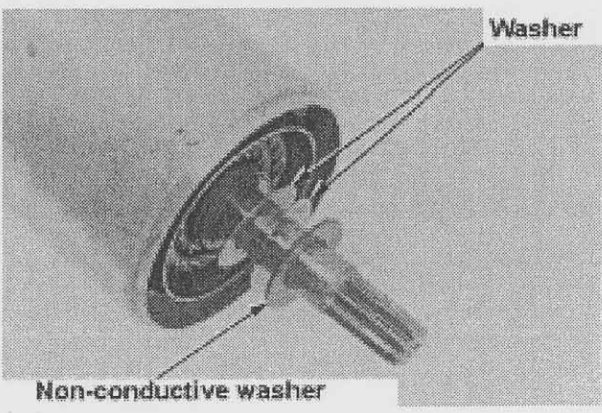

Install the following parts:

- Lock washer

**Note:**  
Set the lock washer catch to the slit on the front cover to install the washer.

- New O-Ring
- Front cover

**Note:**  
Align marks on the front cover and the motor case.

- New O-Ring
- Plate
- Assembly bolt

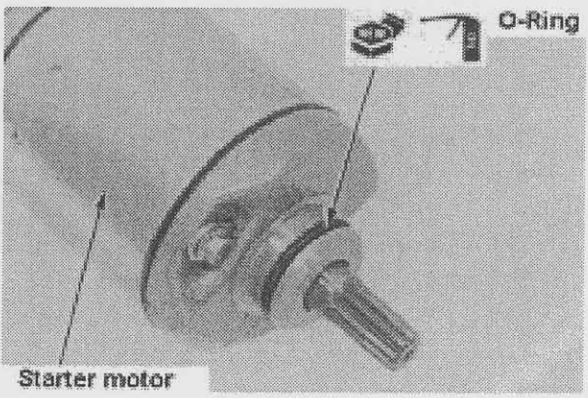
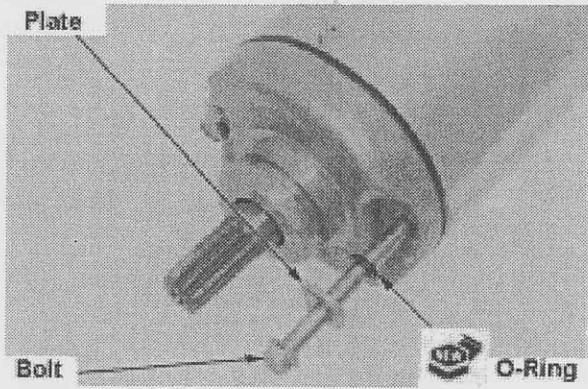
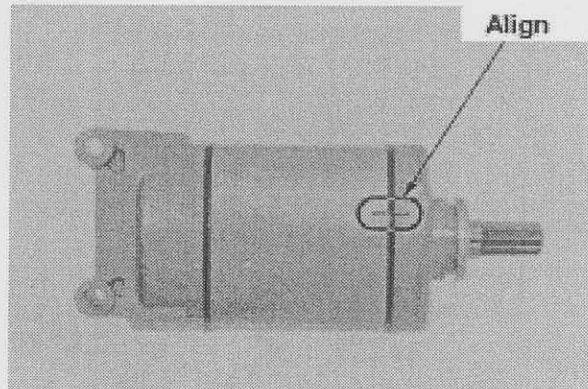
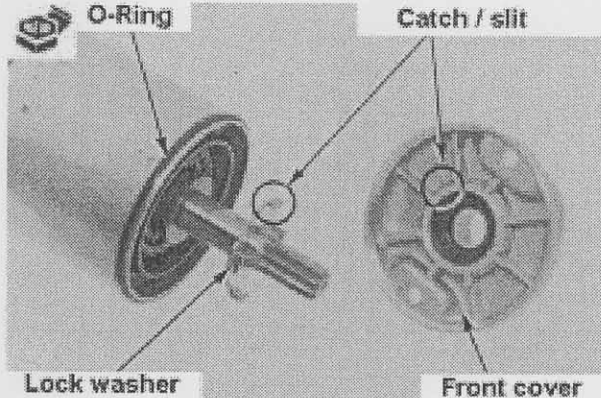

• Installation

Apply engine oil to a new O-Ring.

Install the following parts:

- The new O-Ring
- Starter motor

Install the following parts:

- Earth lead
- Starter motor bolt
- Starter motor cable
- Starter motor cable nut
- Rubber cap

**Notes:**

- Refer to the routing diagram (1-21) when routing leads (cables).
- Firmly set the rubber cap after all installation.

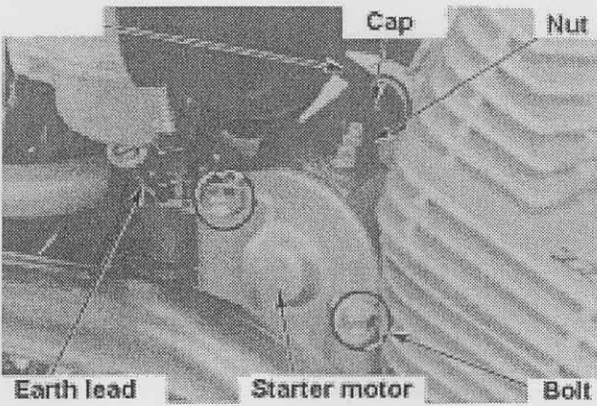

Inspect the starter reduction gear for wear/damage and replace it if necessary.

Inspect the starter reduction gear shaft for wear/damage and replace if necessary.

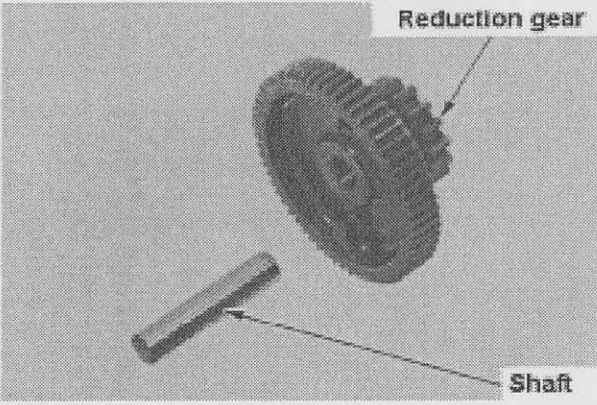

Apply engine oil to rubbing area and install the gear shaft and the starter reduction gear.

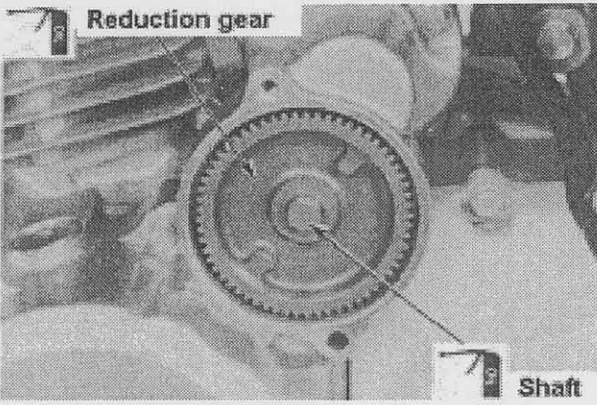

Replace the O-Ring if any damage was found.

Apply engine oil to the O-Ring and install it to the starter reduction gear cover.

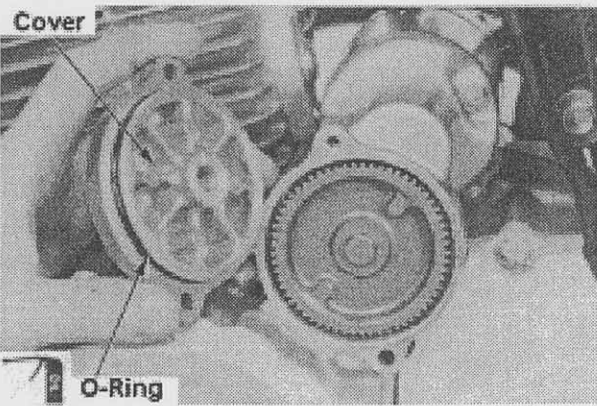

Install the starter reduction gear cover and screw bolts.

- Starter Relay Switch
- Inspection

**Note:**  
Check battery status, prior to the inspection.

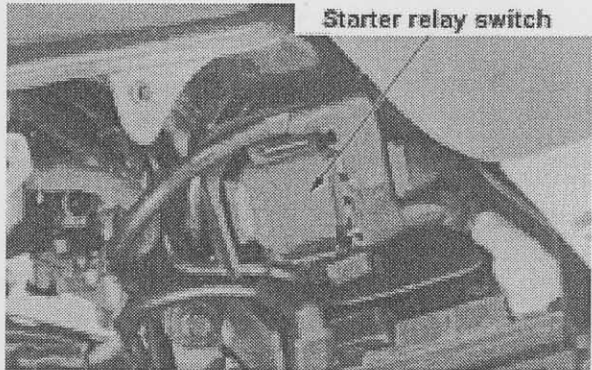
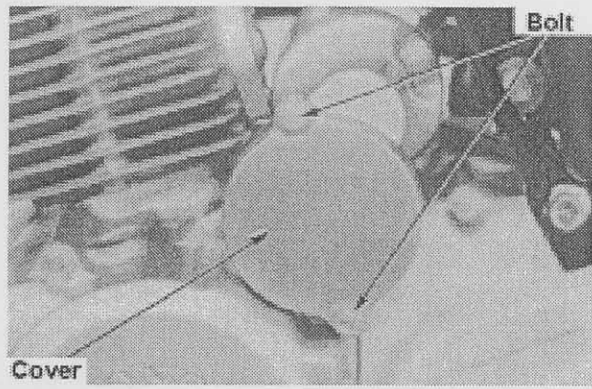

Remove a left side cover (2-2).  
Turn the ignition ON, kill switch RUN.  
Click sound should be heard from the starter relay switch by pressing the starter switch.  
Conduct the following inspection if the click sound could not be heard.

• Input Voltage Check

Set the transmission to neutral.  
Connect a voltmeter to the harness side terminal of the starter relay switch 4P coupler.  
Turn the ignition ON, kill switch RUN and measure the voltage when the starter switch was depressed.

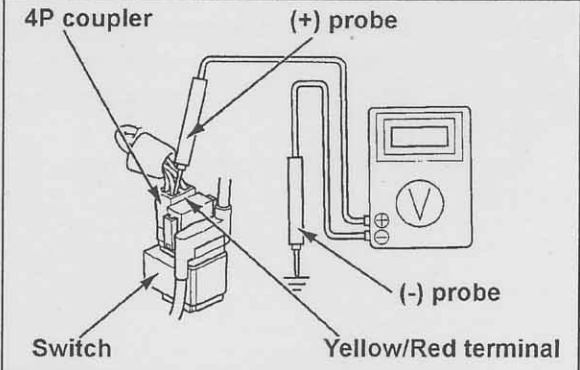

Connection: Yellow/Red (+) - body earth (-)  
Standard: Battery voltage

• Ground Earth Check

Disconnect the starter relay switch 4P coupler.  
Inspect continuity on the harness end of the 4P coupler.

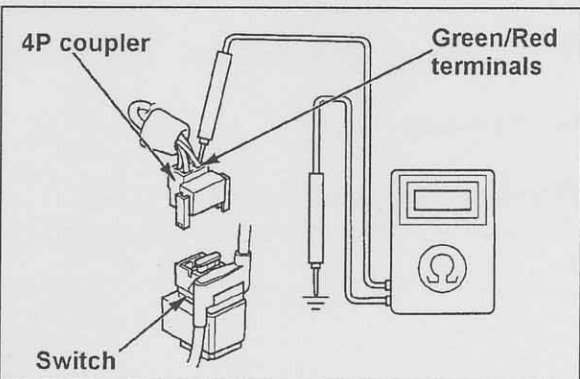

Connection: Green/Red - body earth  
Standard: Clutch lever held: continuity  
Clutch lever released: no continuity

- **Operation Check**

Disconnect the starter relay switch.  
 Connect a fully-charged battery to the starter relay switch.  
 Inspect the continuity between terminals.

Battery connection: Yellow/Red (+) -  
 Green/Red (-)

Standard: Continuity

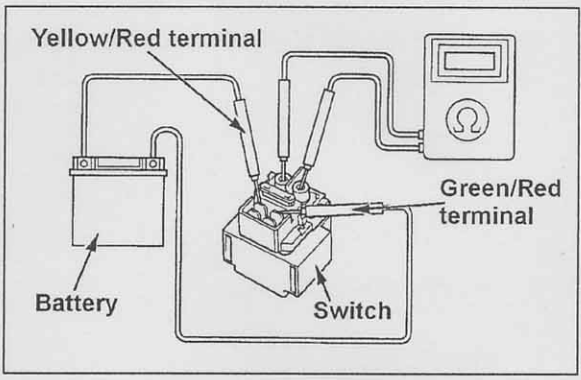

Continuity should only exist when voltage is applied.

- **Clutch Diode**

- **Inspection**

Remove a fuel tank (2-10)  
 Remove a tape to remove the diode.

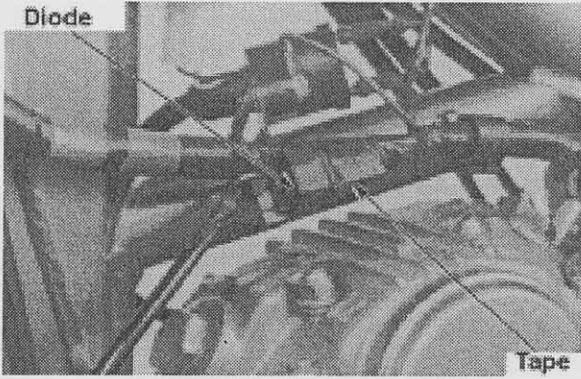

Inspect the continuity between the terminals.  
 As diode is a semi-conductor, the direction with small resistance is considered to be a continuity.  
 The continuity should exist in only one direction.

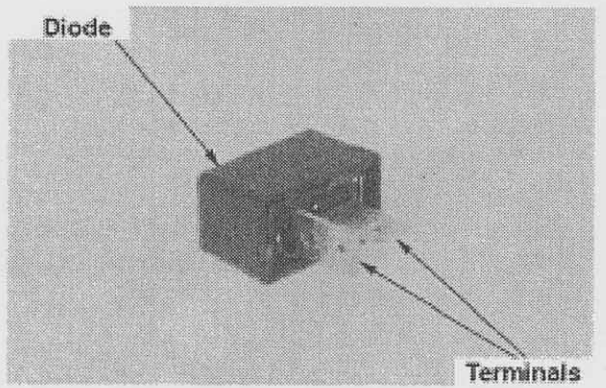

- **Flywheel / Starter clutch**

- **Removal**

Remove a left crankcase cover (14-9).  
 Remove a shaft and a starter idle gear.

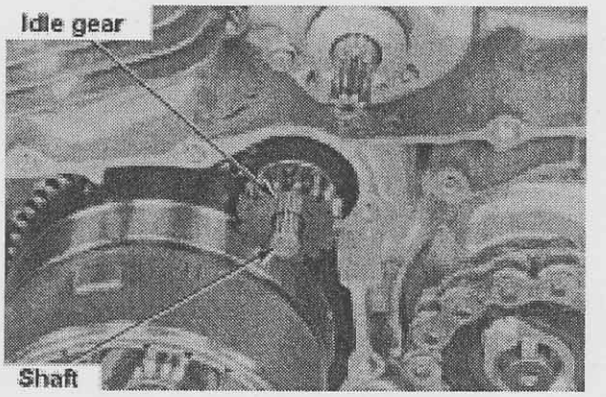

By using a flywheel holder, firmly hold a flywheel and remove a flywheel bolt and a washer.

Special tool:  
Flywheel holder      07725-0030000

Remove the flywheel by using a flywheel puller.

Special tool:  
Flywheel puller      07733-0020001

Remove a washer and a woodrough key.

**Note:**  
When removing the key, do not damage the key slit or the crankshaft.  
Do not lose the key after removing it.

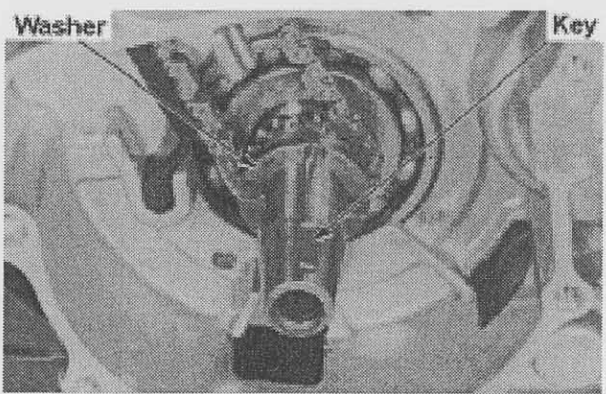
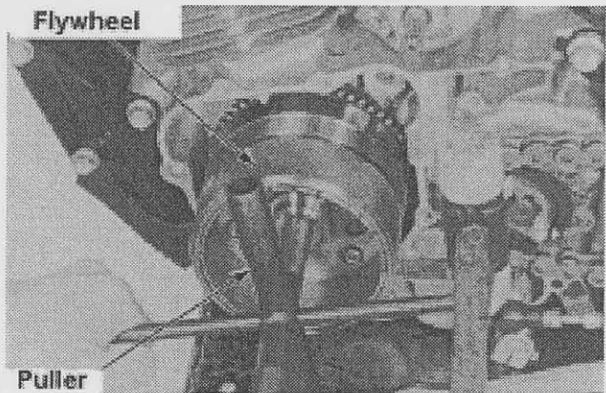
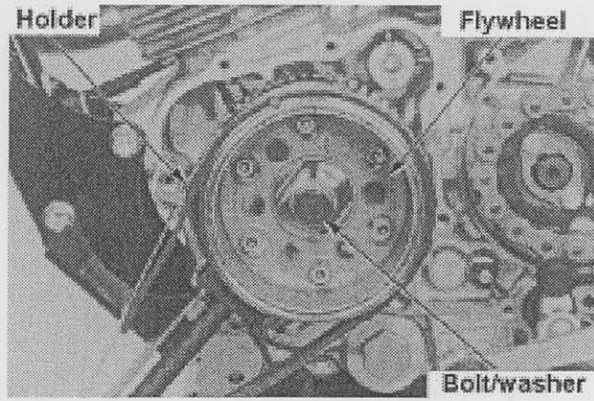

• **Disassembly**

Remove a starter driven gear by turning it anti-clockwise.

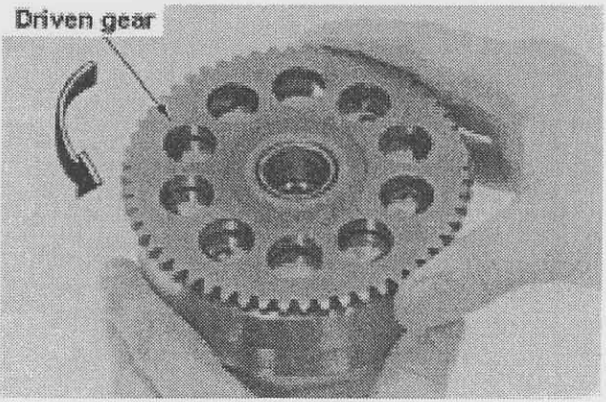



Hold the flywheel with the holder and unscrew socket bolts.

**Special tools:**

Flywheel holder 07725-0030000

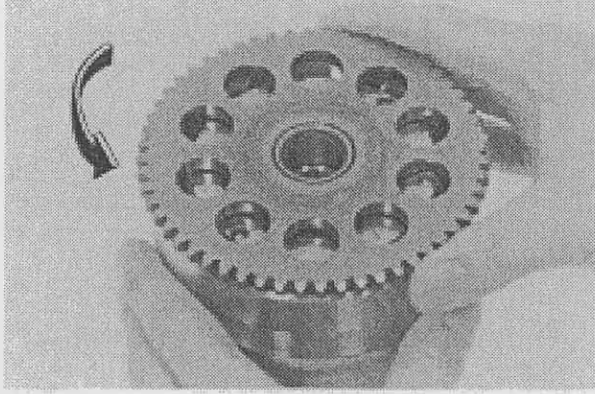

Remove a clutch outer and a one-way clutch.

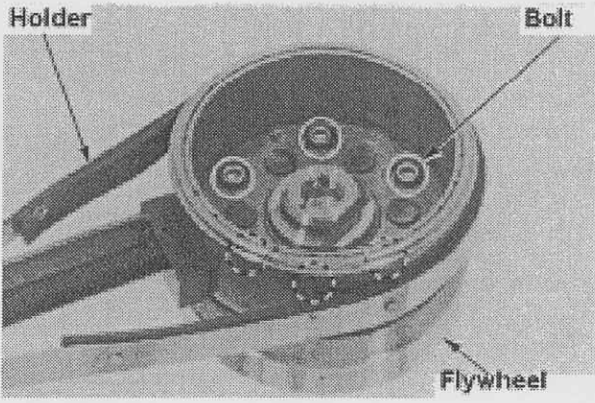

**• Inspection**

Install the one-way clutch and the starter driven gear to the clutch outer. Confirm that the driven gear may only be turned in one direction.

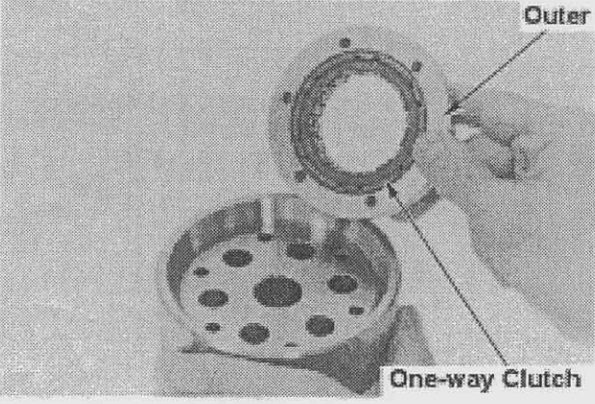

**• One-way clutch**

Inspect the clutch for unusual wear/damage and mechanical failure.

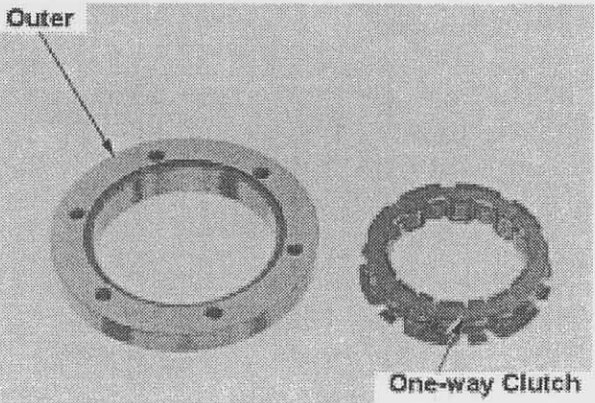

**• Clutch outer**

Inspect the contact surface to the one way clutch for damages.

- **Starter driven gear**

Inspect the contact surface to the one-way clutch for damages.

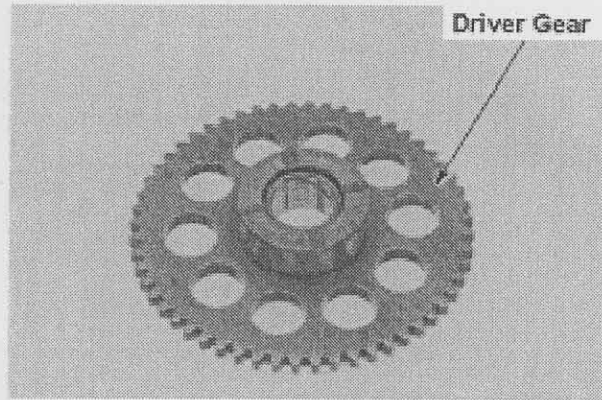

- **Starter idle gear / shaft**

Wear/damage on the gear/shaft → replace.

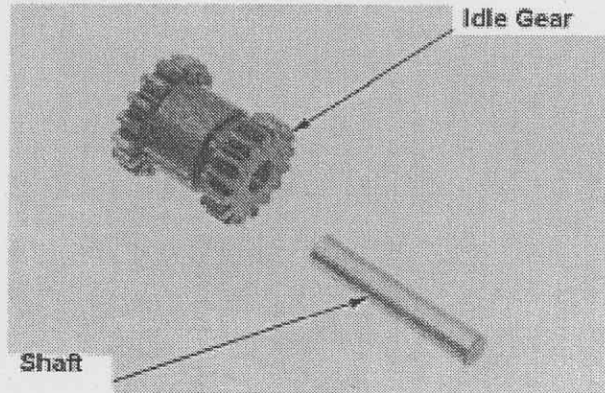

- **Assembly**

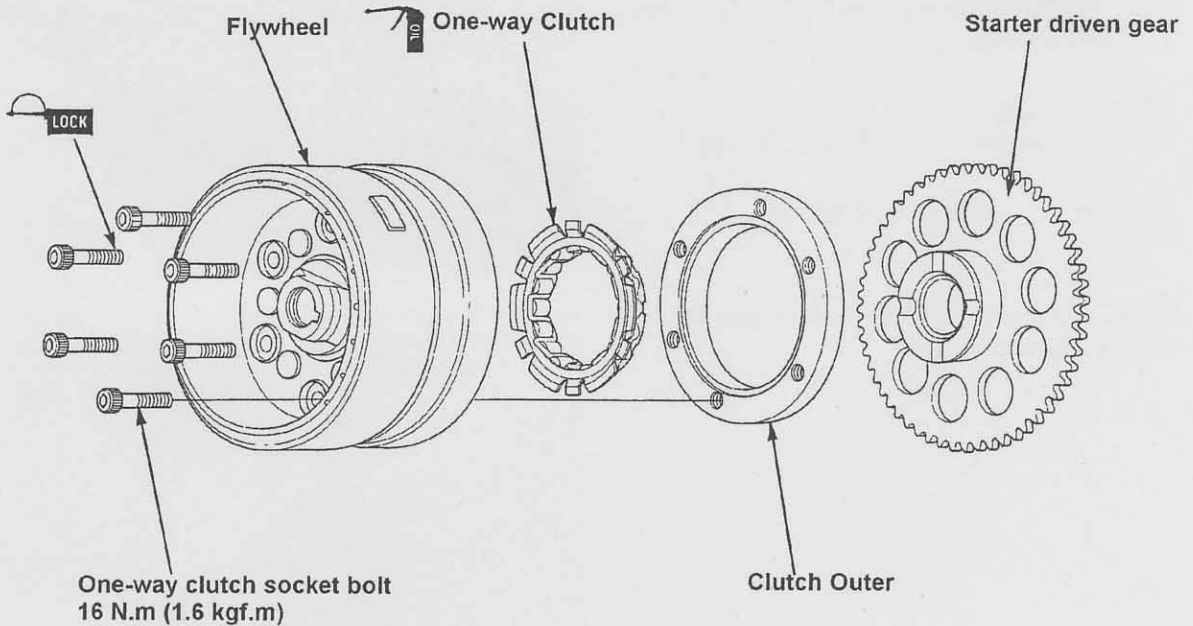

Clean the one-way clutch and apply engine oil.

Install the one-way clutch to the clutch outer so as to have its flange side to the flywheel side.

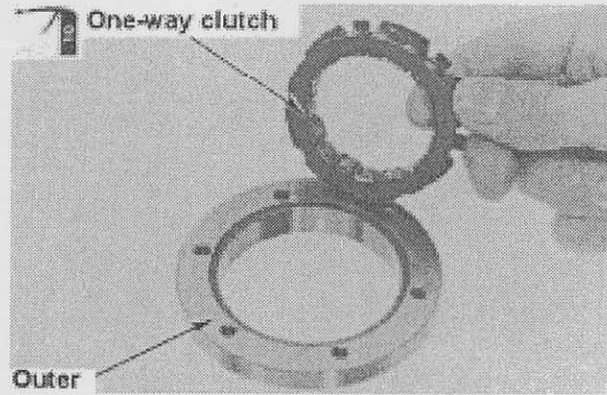

Install the one-way clutch Assy to the flywheel.

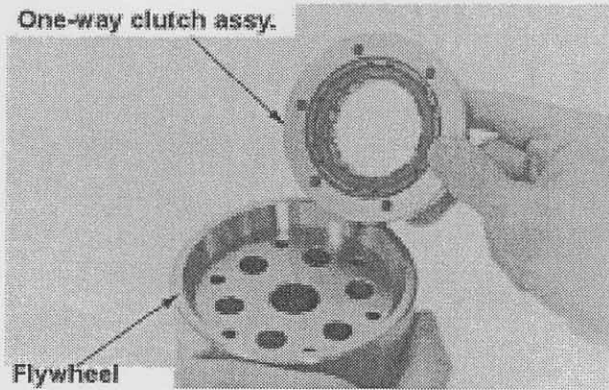

Clean one-way clutch socket bolts and apply screw locker.  
Hold the flywheel with the holder to screw the socket bolts.

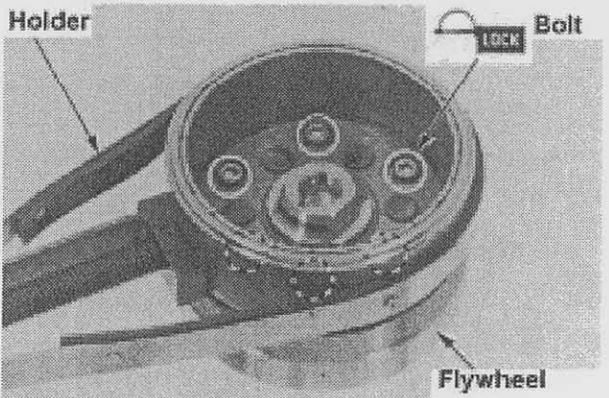

**Special tools:**

Flywheel holder 07725-0030000

**Torque: 16N.m (1.6kgf.m)**

Install the starter driven gear by turning it anti clockwise.

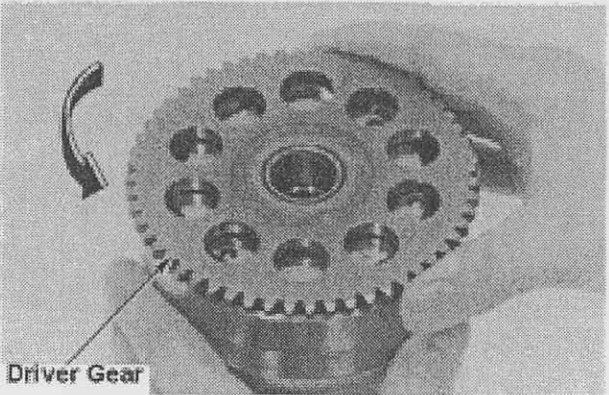

• Installation

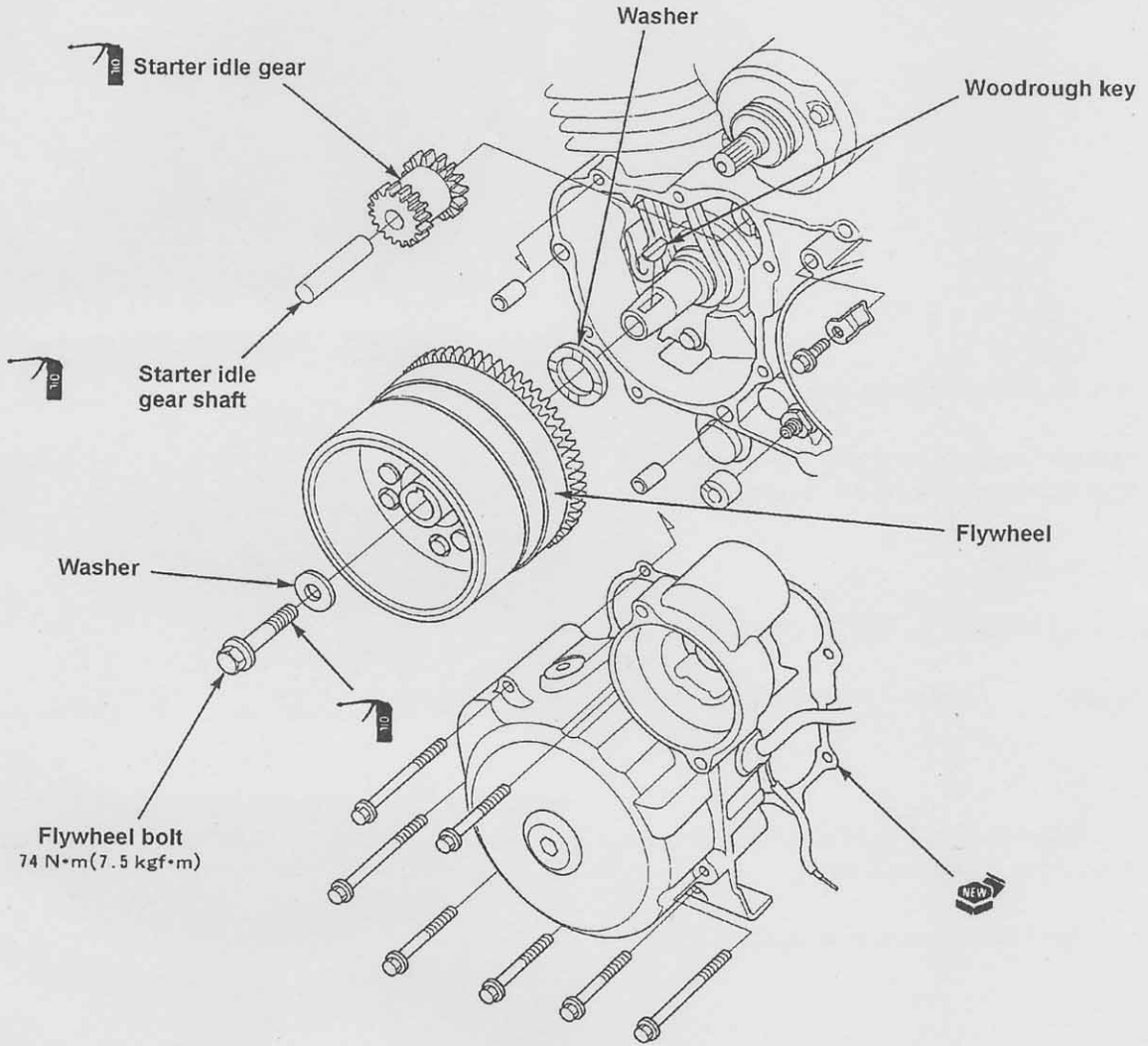

Clean and degrease the tapered part of the crankshaft and install the woodruff key to it.

Install a washer.

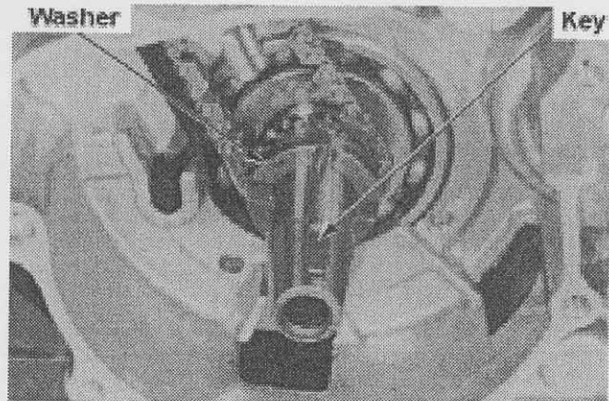

Install the flywheel by aligning the flywheel key slit to the crankshaft woodruff key.

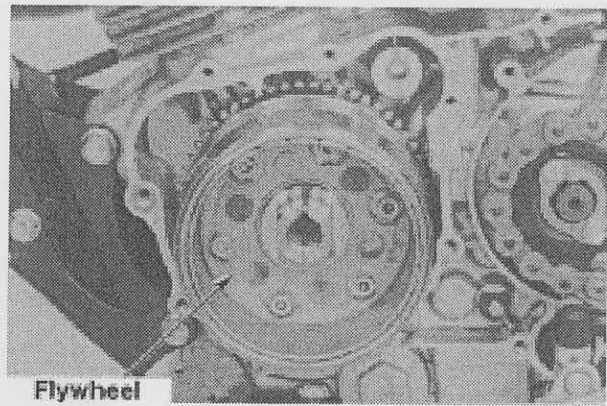

Apply oil to the flywheel bolt.

Hold the flywheel by using the holder and install the washer and the flywheel bolt.

**Special Tool:**

Flywheel holder: 07725-0030000

**Torque: 74N.m (7.5kgf-m)**

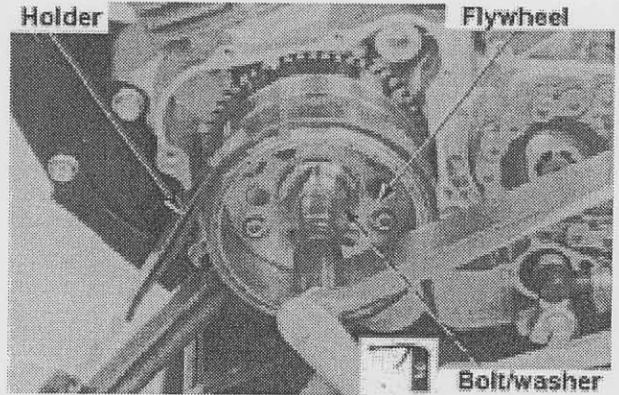

Apply engine oil to the starter idle gear and shaft before installing them.

Install the left crankcase cover (14-12).

