

YAMAHA MOTOR NEWS 1988 No.7

YAMAHA Yamaha Motor Co., Ltd. PUBLIC RELATIONS DIVISION., 2500 Shingai, Iwata-shi, Shizuoka-ken, Japan Tel: 05383 (2) 1145 Telex: Iwata 4263-751 Yamaha J Fax: 05383 (7) 4250

CHAMPIONS! Lawson on the YZR500 and Van den Berk on his modified YZ250

1988 WORLD
CHAMPIONSHIP
ROAD RACING
AND
MOTOCROSS



Van den Berk has scored points in every one of the 24 races this year.



In the Portugal GP, Lawson, Rainey and Magee sweep top 3 positions.

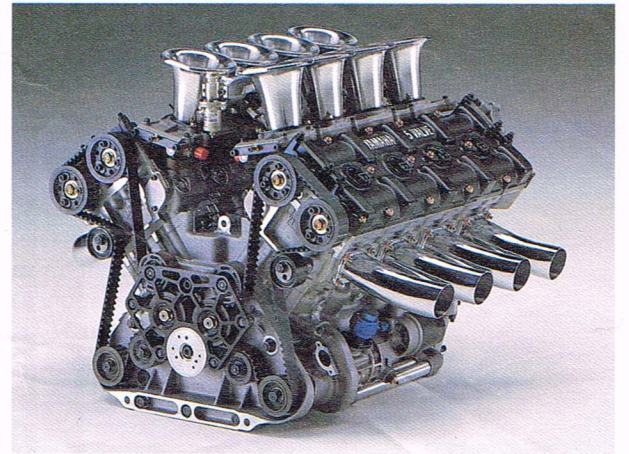

Yamaha to make its debut in F-1 racing with Zakspeed, W. Germany

Yamaha Motor has decided to form a new Formula 1 World Championship Team jointly with Zakspeed Formula Racing GmbH & Co. KG located in Niederrissen, Germany (President, Mr. Erich Zakowski) for entry in the '89 F-1 World Championship series. The new team, "West Zakspeed Yamaha", will use Yamaha's newly developed OX88 engines on its new racers.

Zakspeed Formula Racing has long been involved in a number of programs concerning the construction, development and racing of F-1 and other championship cars.

Yamaha has actively participated in national F-2 and F-3000 championships since 1984 when it developed and unveiled its first racing car engine, the OX66. The newly developed OX88 engines due to be mounted on these racers are 75° V-8, 5-valve 3,498cc models that put out 600hp or more.

By the way, on September 25, Aguri Suzuki drove a Yamaha OX77-powered racer to 2nd place in the 7th round of the Japanese F3000 automobile race series. In doing so, he clinched the '88 championship with the final round left to go.

Yamaha Motor also grabs manufacturer's titles

Two Yamaha champions were crowned in the 1988 World Grand Prix races and Yamaha Motor won two manufacturer's titles as well.

In 500cc-class World Championship road racing, American Eddie Lawson took the title with a total of 252 points on his YZR500, beating Honda rider Wayne Gardner by 23 points. This was the third championship for Lawson, who won in both 1984 and 1986. Yamaha riders Wayne Rainey, Kevin Magee and Christian Sarron took the third through fifth final positions. With the brilliant performance of these riders on works

YZR500s, the machines that embody Yamaha's highest technology, Yamaha Motor was named manufacturer's champion for the third consecutive year.

In 250cc-class motocross racing, John Van den Berk, a 21-year-old Dutchman riding for the YMENV team, won on a modified YZ250, and became the first rider to win in two different classes in successive years, after winning the 125cc-class championship in 1987. He racked up points in all 12 rounds (24 races) and also won Yamaha the manufacturer's championship in the 250cc class. (See page 7 for race details.)

Starting production of high performance engines for Ford Motor

The first engine to be built under a 1985 agreement to develop and supply a high-performance DOHC engine for the US Ford Motor Co., came off the line at Yamaha Motor on July 19, marking the start of production.

Called the SHO (Super High Output) engine, it is a 24-valve DOHC V-6 engine that puts out 220hp/6,000rpm.

Ford is expected to install the SHO engine in the "Taurus SHO", the sporty version model of its bestselling car, the "Taurus",

and to sell it as a 1989 model for the U.S. market, beginning in the fall of this year. On July 19, the commemorative ribbon-cutting ceremony was held at the new SHO engine assembly line at Yamaha Motor's main factory, and the many Ford and YMC officials who attended reaffirmed their determination to see this new venture succeed and grow.

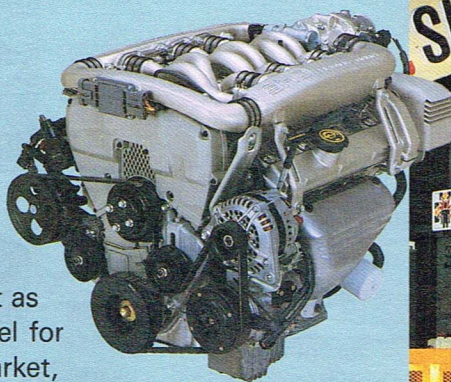

From left: Mr. Ben R. Lever III, President of Ford Motor Company (Japan) Ltd., Mr. J. W. Risk, Chief Engineer and former Program Manager for the TAURUS, Mr. Tadanori Arata, Senior Managing Director, Mr. Shunji Tanaka and Mr. Ryuichi Yamashita, Directors of YMC.

170 dealers gather for first national conference

The first national conference for Yamaha dealers was held in Brisbane from July 27 to 29. This important nationwide conference came at an auspicious time, not only marketwise but historically as well. Since it corresponded with one of the big events of this year's bicentennial celebration, the Brisbane EXPO 88, this city was the natural choice for the conference site. Despite considerable cost in terms of travel expenses and loss time, the response was great from the dealers, with 170 making the trip to Brisbane.

The first two days of the conference were taken up with a very practical and beneficial seminar in dealership operations, with the main focus on increasing profits. A banquet at the end of these two days gave the participants a fine opportunity to renew friendships and business contacts and to further discuss business points raised in the seminar. The third day was devoted to YMC's presentation of its new models and advertising and promotional plans. The models unveiled here included the DT200R, YZ125W, YZ250W, YFM100, YFM250, CW50 and a prototype YFM250 "Tray Back". The dealers were enthusiastic about all the models, especially the DT200R and the YZ range. And YMC's Director Mr. Morinaga's announcement about the upcoming '89 model FZR1000W was also very well received. As a whole the conference was considered such a great success that every one is looking forward to the next nationwide meet already.

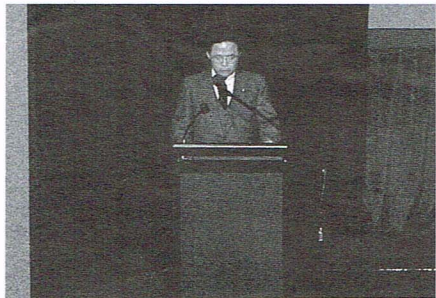

YMC's Director Mr. Morinaga addresses the conference.

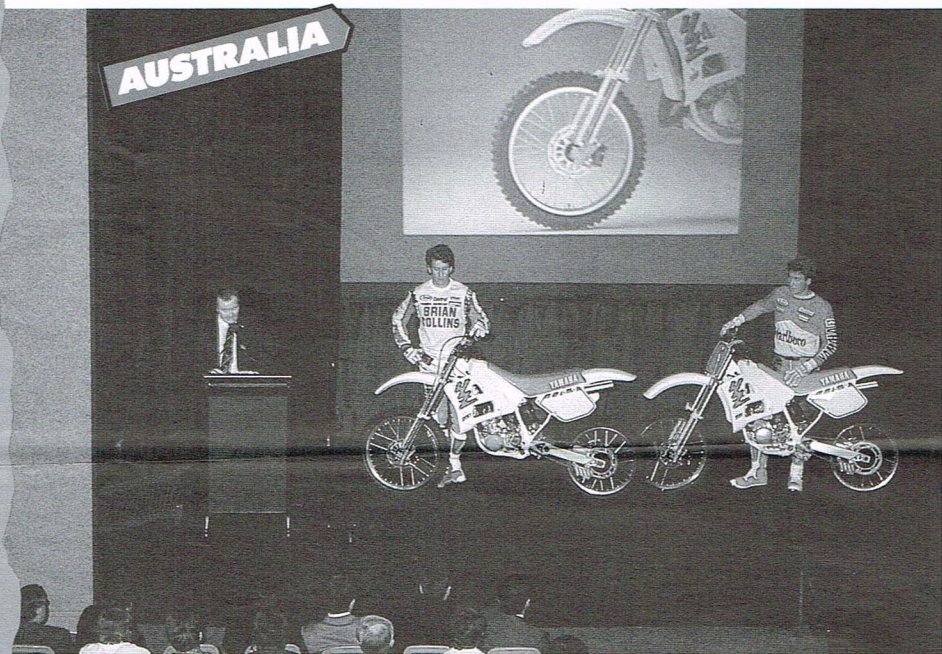

Thanks for all your letters. We're receiving wonderful letters with interesting topics for Yamaha Motor News from all over the world and every letter we get helps us bring you a more informative and more useful Yamaha Motor News.

So, please keep the letters coming.

Handicapped rider tours from Cebu to Manila

PHILIPPINES

Introduced here is an admirable Yamaha motorcyclist who we learned about in the Philippine press recently and thought would be of interest to our readers. The biker's name is Mr. Carlos "Manly" Enaje, 38, of Cebu Island. Although physically handicapped, this May he made a bold 12-day tour on his

Yamaha XJ400 from Liloan on the island of Cebu to Manila. Some 13 years ago Mr. Enaje set out alone to stop a band of four rustlers, but the rustlers turned on him, hacked him with knives and left him for dead. As a result he lost both his arms and, with them, his will to live. Twice he attempted suicide before finally finding the courage to accept

his new life and to live it to its fullest. While continuing to manage his rice and coconut farm, Mr. Enaje, who had once been an avid motorcyclist, decided to find a way to resume his old hobby. He fitted his bike with special handbars and began a period of long, hard training. Mr. Enaje said he made his recent tour to show people that an aquired physical handicap like his is not the end of the world. It is reported in the paper that financial help for this courageous tour came from the Norkis Trading Co., Inc., Yamaha importer.



A prominent article about Mr. Enaje in the Manila Chronicle's "A Chronicle Magazine".



The specialists line up behind the new Pro Hauler. From left: Mr. Tom Morrison (West), Mr. Dan Grigsby (East), Mr. Greg Bradley (South) and Mr. Ryan Bauer (Midwest).

Yamaha ATVs and 4 U.S.A. specialists highlight show

A display of dependable Yamaha ATVs backed up by four macho specialists—these were the main attractions of the Yamaha booth at the '88 International Lawn, Garden and Power Equipment EXPO held from July 25 to 27 in Louisville, Kentucky. At this show, YMUS displayed its Terrapro and Big Bear models as well as a Hydraulic System (Yamaha HS-6) for Terrapro attachments. The system can be used with a variety of hydraulic attachments already available on the market. The display and demonstrations of this system drew outstanding response from show visitors and it is hoped that this interest will translate into a big boost in demand for the Terrapro. A follow-up utility model for the Terrapro, the new "Pro Hauler" was also on display. This model is scheduled for release on the U.S. market next spring as a light commercial vehicle aimed to further consolidate Yamaha's place in the utility field. There to answer questions about the ATVs from the nationwide gathering of dealers was another impressive line up. These four specialists, who stand an average of 6-ft 2-inches and weigh in at 226 pounds, epitomized the young, strong and energetic image of the Yamaha ATVs and were every bit as popular as the models they touted.

The expanding world of marine sports

JAPAN



This summer marked the 14th edition of the annual "Yamaha Cruiser Festival" for the Osaka Bay area held on nearby Awajishima Island with a fleet of about 30 entries. This yacht race is one that caters specially to owners of Yamaha cruising yachts.

The past few years have witnessed a dramatic growth in the popularity of marine sports, accompanied by a boom in the construction of marinas and multi-use marine resorts in Japan. This year saw a notable increase in the number of families and women among both participants and audience.

Yamaha in the Antarctic

Recently a new species of big bear appeared around New Zealand's Department of Scientific and Industrial Research Scott Base in the Antarctic. And the bear is very popular among the people of the base. One glance will tell you this is no ordinary bear. Yes, it is a Yamaha YFM350FW Big Bear. It has been custom fitted with six wheels, and a track conversion to give it the capability to go almost anywhere on ice and snow. DSIR's Antarctic Division personnel have been very satisfied with the

new vehicle, which has proven its worth as a versatile means of transport around Scott Base both as a tracked or wheeled vehicle. In fact, people at the base are so pleased, there are now plans to purchase a second one. The track-kit was imported from the U.S.A. and conversion was carried out by an engineering company in New Zealand, to make it a very versatile vehicle that can be reconverted to the wheeled configuration in just 60 minutes.

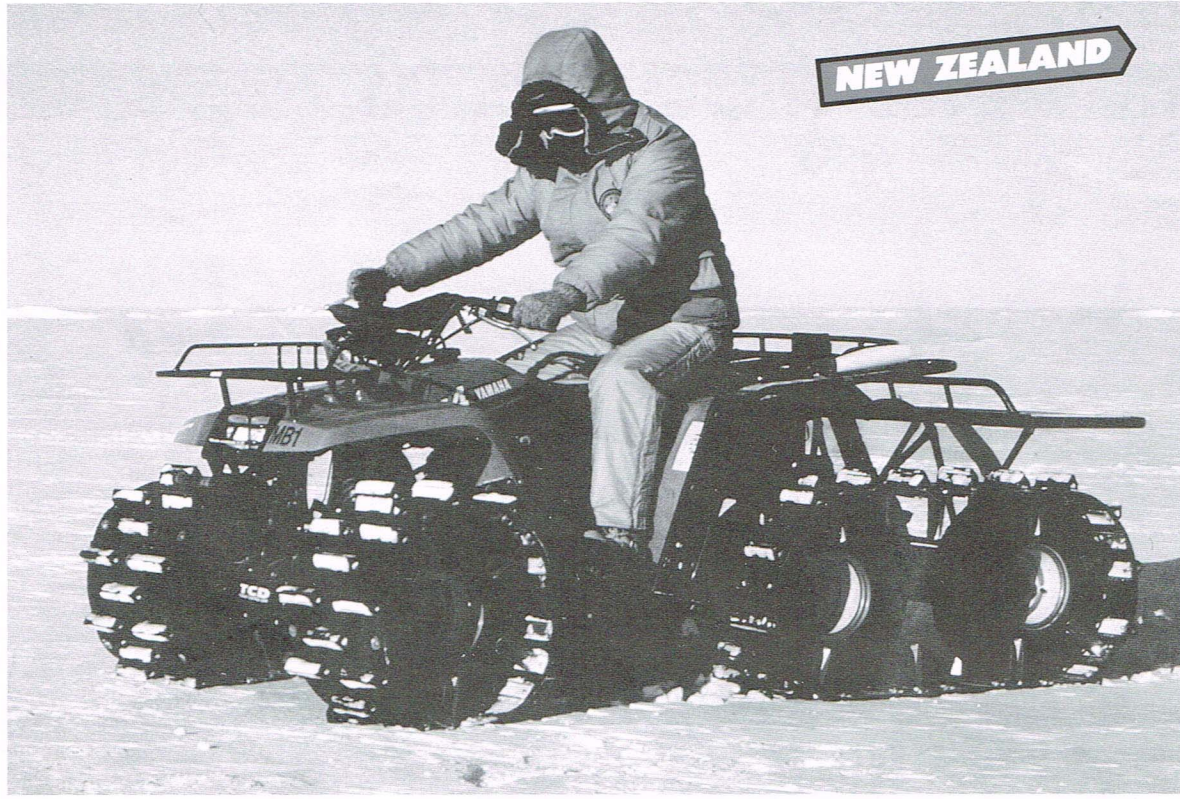

Ténéré: a great way to tour the world

JAPAN

The young Japanese couple of Noriko and Akira Saito, who started out last summer on a pair of XT600 Ténérés to circle the globe, are continuing to have a marvelous trip. Up to this point they have toured through Canada, the U.S., Mexico, Colombia, Chile, Argentina, Uruguay and Brazil. Then across the Atlantic to Great Britain and Scandinavia, for a total distance of about 30,000 miles (48,270km). And wherever the two go they have always gotten a warm welcome. Brazil is a good example. Their visit was picked up in a big way by local press and television. Because, at that time, domestically produced Ténérés had just been released on the Brazilian market for the first time and they happened to be in Brazil in the midst of the ensuing Ténéré fever. So, their tour through Brazil had an extra publicity effect for the bike in Brazil. Then in England the Saitos were popular visitors when they hopped over to watch the famous TT Race on the Isle of Mann. Wherever the couple goes, however, talk always seems to come around to two subjects; people's amazement at how easily little 153cm Noriko handles her XT600, and what fine condition the tough Ténérés have maintained on such a long and grueling trip.

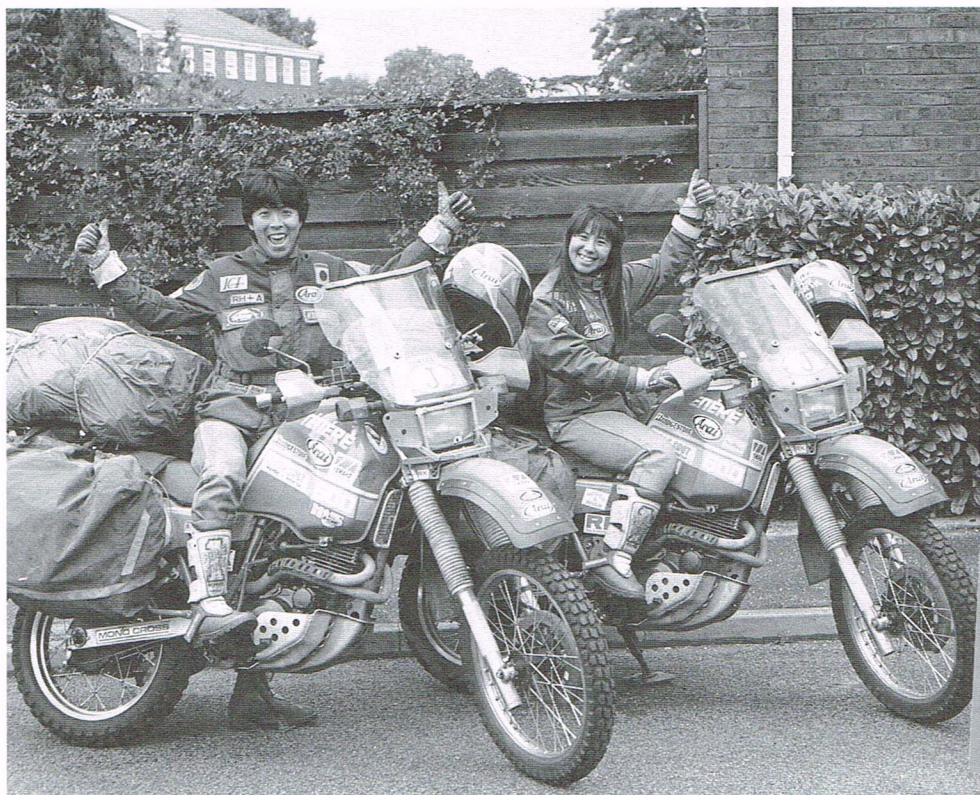

Akira and Noriko in Great Britain.



A new office reflects bright future

SINGAPORE

Yamaha's long-standing marine importer, Supratechnic, recently opened a new office and showroom in Geylang, Singapore which is one of the most important economic countries in Southeast Asia. The new facility, of course, features a workshop and parts stockroom as well, all on a grand scale that shows the company's expectations for big business growth ahead. The opening ceremony on August 8 was thronged with guests come to offer congratulations for the new showroom and for the company's ongoing prosperity.



Letters from readers

National Integration Run in India on an RX100

Riding an RX-100 across India from north to south was a great joy and a thrilling experience for me. I was the only girl amongst 27 riders selected for the National Integration Run to commemorate 40 years of independence. Our team started out from Chanakyapuri, New Delhi, on May 28 and reached Gandhigan, near Madurai on June 30, in time for the National Integration Youth Camp organized by the Dept of Youth Affairs.



The cross-country run covered six states, and took in crowded cities and small villages, rivers and plains. Seven of us rode powerful Yamahas; three on Rajdoot-350s, and four (including myself) on RX-100s. This long journey was a real test of the power and reliability of the bikes and they really proved their worth. My association with the RX-100 began in December 1986 when I conspired with my elder sister to purchase one without the knowledge of my parents. I had always fancied going to college on a bike like the boys. When I told my family about the rally, they surprised me to participate, but also encouraging me and preparing me for it. Also, Escorts Limited provided me with a kit for the journey and rendered valuable assistance enroute through their well organized network of service stations. For the last two years I have been glad to own an RX-100. After this run, I'm positively proud to be a Yamaha owner. Archana Tanvar, India

*Thank you so much for your letters. Unfortunately, for lack of space, Ms. Tanvar's letter had to be edited slightly. - Editorial Room

A 5,200Km trip to the polar circle on an RDLC2

Hello! This summer holiday, I rode my RDLC2 from Hameln in north Germany to the middle of Norway, near the polar circle. It was a trip of about 5,200km. Sometimes, my route took me nearly 2,000m up into the mountains. I rode for hours without seeing a house, or a car, or even another human being, on very bad roads through a wonderful landscape of unspoiled nature. I had to have absolute trust in the technical reliability of my small motorcycle. I was really impressed with the motorcycle, especially at just 80cc! It proved itself to be capable of the longest trips. Next year I'll do the tour again.

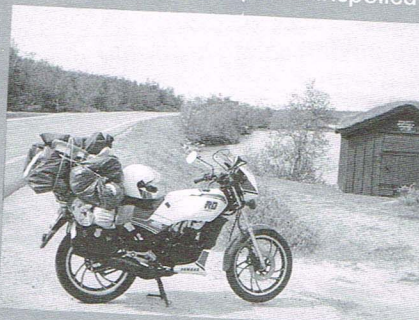

Wiels-Holges Peters, West Germany

APOLOGIES

In the No.6 issue of Yamaha Motor News we failed to mention in the "24th PBRO Rally" article on page 8 that the rally took place in New Zealand. We apologize for this oversight.

Models that have opened up a new category have built a joyous new world of off-road

HISTORY OF YAMAHA DT SERIES

DEVELOPMENT PROCESS FROM THE ADOPTION OF LIQUID-COOLED ENGINES TO THE

'82 DT125LC



'84 DT200R



LIQUID-COOLED, CRANKCASE REED VALVE INDUCTION ENGINE
'88 DT200R

YPVS power characteristics

The '84 DT200R became the first DT model ever to adopt the long-proven race-bred YPVS.

RISE-RATE MONOCROSS REAR SUSPENSION
'88 DT200R

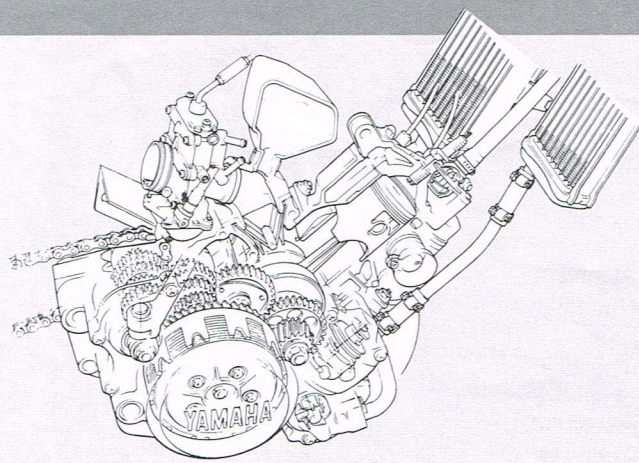

YPVS power characteristics

VARIABLE EXHAUST VALVE

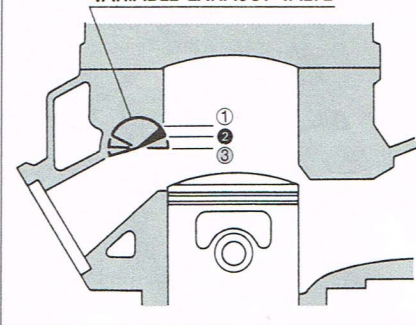

In a YPVS-equipped model the valve adjusts automatically depending on engine rpm, resulting in exciting high speed performance and reliable low speed power from a single engine.

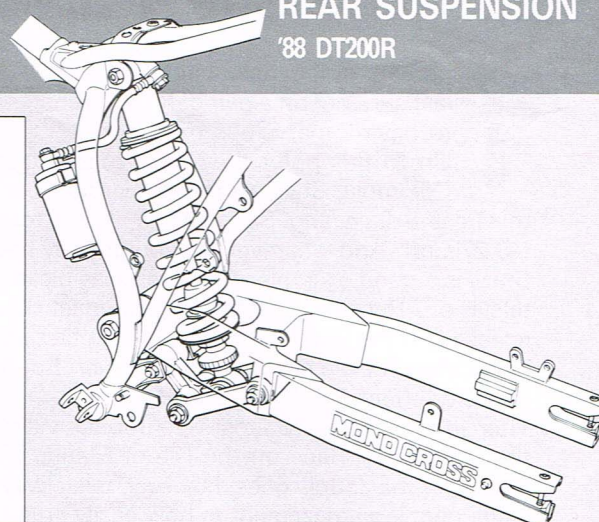
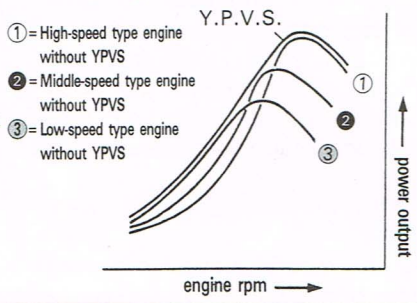

Introduced in Part 1 of our last issue was the development process from the birth of the pioneer model, DT1 to the adoption of a cantilever type Monocross rear suspension. In this Part 2, we are going to explain the new technological progresses leading up to the birth of the '88 DT200R.

Adoption of a liquid-cooled engine

Given a Monocross rear suspension, Yamaha DT series models were improved greatly in both off-road maneuverability and riding comfort. And this naturally led to the possibility of even higher power output. But, conventional air-cooled engines had their limits in this regard. In 1982, Yamaha provided a solution to this problem by re-designing the new DT 125 as a liquid-cooled model based on YZ-proven technology. The DT125 came out as the world's first liquid-cooled production trail model.

The liquid-cooling system not only helped increase power output, but also prevented heat-caused power loss. What's more, the liquid-cooling system proved itself to be a good solution to the growing pres-

sure for more stringent noise control regulations.

Encouraged by this success, up until today, Yamaha has adopted liquid-cooled engines in each and every DT model. The liquid-cooled DT125 pumped out the then highest 125cc trail power output of 16ps/7,000rpm, far above conventional 125cc trail standards. The liquid-cooled DT125 was a unique trail model that packed plenty of power in its compact, lightweight frame. The success of this model fully convinced Yamaha of the great future ahead for the DT series.

A brand-new 200cc format

Yamaha continued to strive toward the development of a new-concept trail model that would be as compact as a 125cc machine but as powerful as a one class bigger machine, and suitable for smooth highway riding with an IT-styled strong, power-matched suspension system.

In 1984, Yamaha unveiled its brand-new 200cc DT200R.

This new-design 2-stroke engine featured a liquid-cooling system. The race-bred

Y.P.V.S. system was also adopted in this engine. This system controls the exhaust timing by means of a variable valve to ensure more effective timing in accordance with each rpm level, thus obtaining higher power output over the entire speed range. With these improvements, the new 200cc engine delivered a maximum power output of 30ps/8,500 rpm, much higher than the last DT250M's 21ps/6,000 rpm. The chassis design also saw important improvements. The conventional cantilever-type Monocross system was replaced with a YZ-proven rising-rate Monocross system that followed every change in road surface conditions much better, while also providing an added cushion stroke.

The front suspension was fitted with a 3-way damping adjuster.

The front brake was a hydraulically operated disc type. These chassis components were also based on YZ-bred technology. And, weighing only 99kg, the new DT200R was as light as a 125cc model.

Indeed, the new DT200R surprised trail fans as a new-generation, fresh-sense trail model. It was as compact and light as a

125cc model, as powerful as a 250cc model, and as dirtworthy as an IT model.

Increasing the number of off-road race fans

The exciting power output that the liquid-cooled DT125 provided was emphasized even more in the DT200R, and added displacement enabled smoother, easier high-speed riding. Aiming at the further development of the trail bike market, Yamaha bolstered the DT line with the new DT125R, adopting basically the same design as the DT200R. The popularity-winning DT200R/125R were also effective in building and promoting the street-legal motocrosser image that helped increase the number of enduro fans using these machines.

While previously the use of trail bikes had been limited mostly to conventional street or off-road riding, the DT200R/125R, helped pioneer an entirely new area of use for such machines.

An even stronger street-legal motocrosser image

Just 20 years have passed since the first

ry and motorcycling

YAMAHA TRAIL DT STORY PART 2

BIRTH OF THE NEW DT200R



'85 DT125R



'88 DT200R



THE YZ-STYLED SINGLE DOWNTUBE
TYPE CRADLE FRAME
'88 DT200R

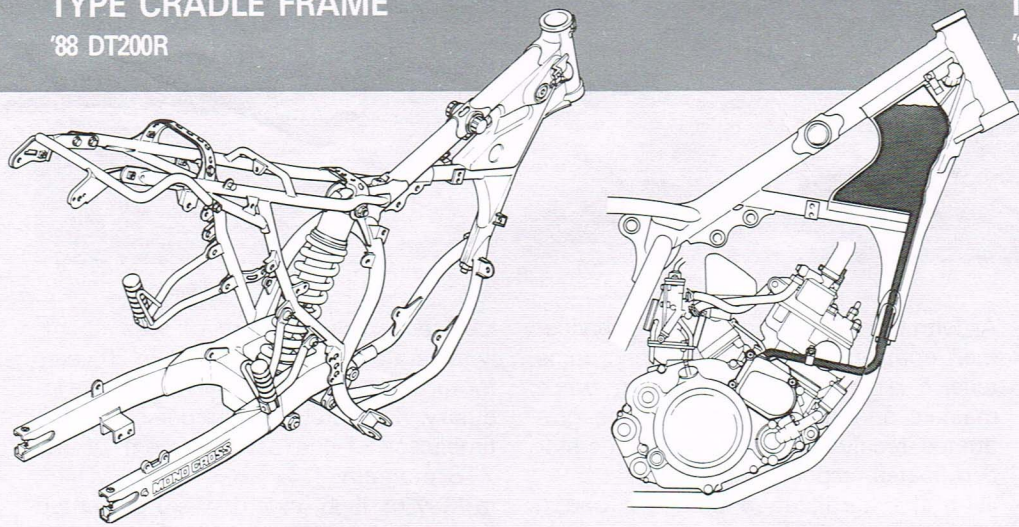

THE FRAME OF THE '88 DT200R
INCORPORATES AN OIL TANK
'88 DT200R

DT1 was launched on the market. This year, 1988, now sees the debut of the new-generation DT200R.

Its style is nothing less than that of the latest Yamaha motocrosser. This means the street-legal motocrosser image has been emphasized much more in this model.

First of all, attention should be given to this model's greatly improved suspension performance. The cushion stroke, both front and rear, is increased to 270mm, equivalent to that of a motocrosser. In addition, the front fork is fitted with a large-diameter inner tube for added rigidity. The DT200R has become a one size larger machine with the adoption of the greatly strengthened suspension system and its dry weight has also increased to 107kg. But, the adoption of a more compact instrument panel and lights together with the discontinuance of the tachometer, has appreciably reduced the force of inertia moment in the steering system. Front and rear brakes are YZ-styled, hydraulically controlled disc type which are watertight and easy to operate. The new-design engine features a crankcase reed valve induction system for

smoother power delivery over the entire speed range.

The maximum power output has also been increased to 33ps/8,500rpm. The oil tank is incorporated in the frame for the best possible utilization of space.

The latest DT200R which can also be used as a real enduro machine, is the embodiment of Yamaha's technological know-how accumulated through the 20-year history of DT development. And throughout this period, Yamaha's consistent development goal has been to make the DT as controllable as possible, thus giving birth to the popular DT200R and DT125R.

While the latest DT200R inherits the technological excellence of its forerunners, it has also served to enhance the reputation of the "DT". This is sure to further consolidate Yamaha's lead in the trail bike market in the 90's.

In the near future the DT200R and DT125R are due to be exported, enabling them to cover all types of off-road activities everywhere in Japan.

Note: All horsepowers referred to here are those of Japanese domestic models.

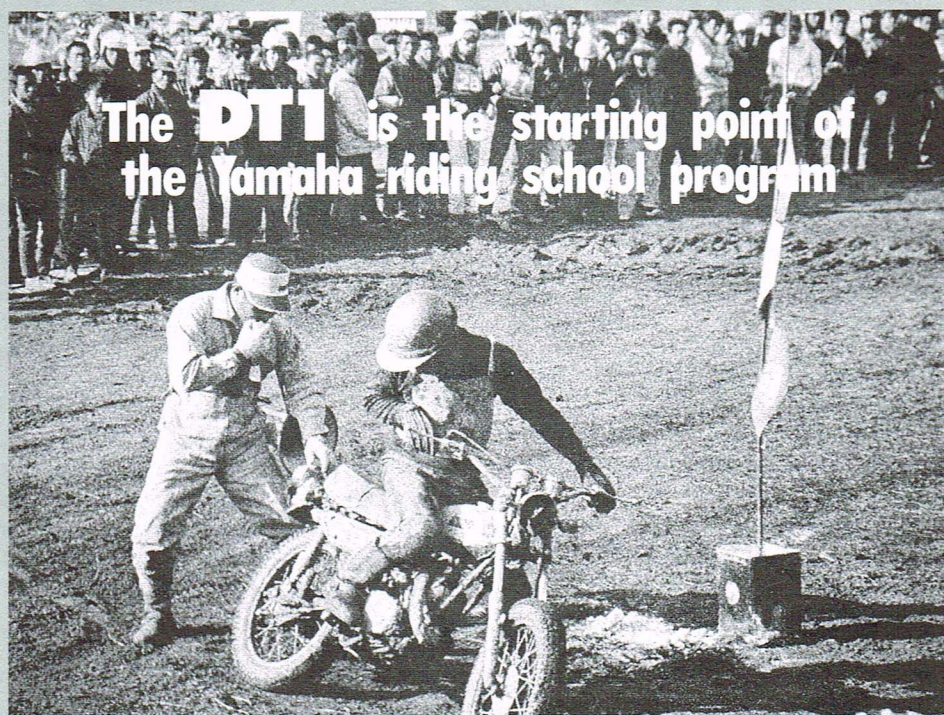

The **DT1** is the starting point of the Yamaha riding school program

Demand-creating activities are an essential part of Yamaha corporate activities. And, our motorcycle riding school program is presently a mainstay of these activities.

The trail school which was opened as part of the marketing activities for the DT 1 is considered as the starting point of this long-lasting program. The DT1 was acclaimed as the first mass-produced trail model ever as soon as it was launched on the market. Its popularity was further boosted by the opening of the trail school as users who had ridden off-road bikes in their own way before, were instructed in correct, full-filled off-road riding tech-

niques for the first time.

Over the years, this successful school program has been followed by a variety of other street and off-road riding school programs, not only here but also overseas.

For example, 12,500 trainees have finished Yamaha training courses in 30 countries other than Japan; 3,300 in the motocross and 9,200 in LTR (Learn To Ride) School.

The Yamaha riding school program which was started with the birth of the DT1 has grown steadily in popularity over the past 20 years in the same way the DT has.

GETTING A GRASP OF MARKET TRENDS

Strengthen your service organization and command customer respect: YTS System



If you are a customer about to purchase a bike, you are going to get basically the same bike no matter where you buy it. But people place importance on the decision of which shop to buy from. What factors shape this decision? The suggestion of a friend; the helpfulness of the staff; the closeness of the shop... Of the many factors involved, one that is receiving particular attention of late is the quality of the technical service it offers.

As a means of helping raise the level of technical service at YSP (Yamaha Sports Plaza = Yamaha sports bike shops) and YOU-shops (Yamaha scooter shops), in May of last year YMC initiated its YTS (Yamaha Technical Service) program. This program has been well received by dealers, among whom it is known as the "Star Shop Ranking System".

Setting specific standards to encourage better service

The new ranking system was conceived in response to a growing demand from the users that has resulted from the increase in popularity of sports models. Recent users demand a higher and higher level of technical expertise on the part of the dealership.

Under this system "Star Shop" status is awarded based on an inspection that evaluates the service capabilities of the shop against set standards in the areas of staff qualification, state of maintenance of workshop facilities and equipment, service policies, etc. Borrowing the example of French restaurants, a ranking of "Single Star Shop", "Double Star Shop" or "Triple Star Shop" is awarded, thus encouraging the dealership to improve its technical capabilities and facilities and thereby achieve a more effective service system.

Goals of the Star Ranking System;

1. To show the users the technical level of a shop based on an objective set of evaluation standards. This in turn helps win user trust and satisfaction and encourages users to become regular customers.
2. To provide specific goals for the shop to strive for on the way toward improving their overall service organization in a clear step-by-step system.

Raising the technical proficiency of service mechanics

Preceding the start of the "Star Shop Ranking System", in May of 1986 YMC began its "Yamaha Motorcycle Service Mechanic Certification Program" with the

Aiming to be 3-star Yamaha service mechanics, these trainees show great enthusiasm.



aim of helping in the technical training of the dealer's service staff and, at the same time, to lay the foundation for the coming "Star Shop" certification system. Under the YTS system, qualifications for recognition as a Yamaha motorcycle service mechanic are divided into three classes.

- Step 1: Yamaha basic class motorcycle service mechanic
- Step 2: Yamaha masters class (2-st.) motorcycle service mechanic
Yamaha masters class (4-st.) motorcycle service mechanic
- Step 3: Yamaha doctors class motorcycle service mechanic

As with the "Star Shop" system, servicemen completing the basic class course receive a one-star certification, while masters and doctors class course graduates receive two-star and three-star certificates respectively.

With the certification comes a badge which the serviceman wears on the chest of his work uniform, while the dealership displays its certificate on the shop wall. In this way the shop can advertise its technical proficiency to the users, while at the same time affording the users a means of selecting the shop they wish to patronize.

It just so happens that, in Japan, a government-approved Motorcycle Serv-

ice Mechanic's Examination was recently reinstated for the first time in 20 years for further prosperity in the motorcycle industry. This step also underscored the timeliness of the establishment of the YTS program.

In May of 1986, awards were presented to the first group of servicemen to be given "Basic Class" certification. Then, in January of last year the first "Masters Class" certifications were granted to qualified servicemen. In the meantime, as of May of this year, 517 shops had been given "Single Star" status, and in the near future a number of these will become recipients of the "Double Star" ranking.

At YMC our goal is to see about 800 of our main dealerships achieve "Single Star" status within the course of this year. Already we are receiving comments like the following from shop owners who have received "Single Star" status concerning the benefits of this program. "Until now, the motorcycle industry has been lacking such a system. It is no less demanding than the government-approved examinations. So, our mechanics are very proud of the fact that they have been certified by Yamaha Motor and it gives them more confidence.

My shop was one of the first to get "Star Shop" status, and since then we have seen a roughly 50% increase in the number of customers coming to us for service."

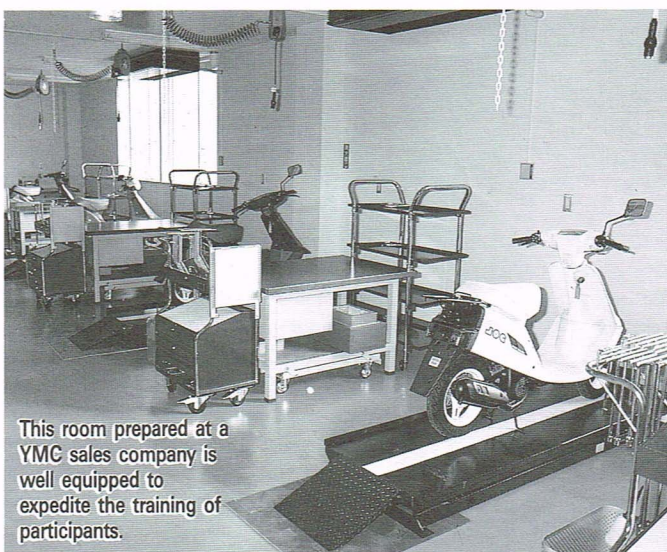

This room prepared at a YMC sales company is well equipped to expedite the training of participants.

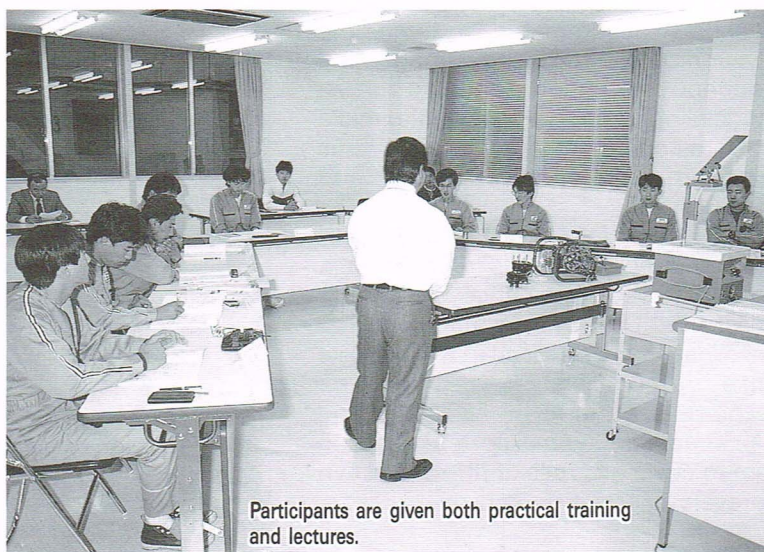

Participants are given both practical training and lectures.

WORLD CHAMPIONSHIP ROAD RACING

Lawson captures his third 500cc crown, Yamaha also makes it three in a row

Yamaha rider Eddie Lawson finished a safe second about 1 second behind Wayne Gardner (Honda) in the 23-lap race of the Czechoslovakian GP, the 14th round of the series held at Brno on August 28. After that, GP riders belonging to the I.R.T.A. decided to boycott the Argentine GP, the 15th round of the series scheduled to take place on Sept. 4, because of its course conditions. And, at the moment the Fédération Internationale Motorcycliste (FIM) finally decided to cancel the Argentine GP, Lawson clinched his third 500cc title at the same time Yamaha won the manufacturers championship for the third year in a row.

Lawson placed high in every round this year, collecting a total of 252 championship points including 7 wins against his Honda-riding, arch-rival Wayne Gardner's 229

points and 4 wins. Also, Yamaha Motor had scored a total of 280 manufacturers championship points when the final round in Brazil was over, leading Honda by 38 points. Lawson, of course played a vital role in this success, but other YZR500 riders, Wayne Rainey, Christian Sarron and Kevin Magee also made a big contribution. In the 250cc class, Juan Garriga on a YZR250 fought fierce battles

with A. Pons until the very last round held in Brazil on September 17. In this race, he fell back to 23rd position after running off the course to avoid being involved in M. Wimmer's 2nd-lap crash. But he valiantly rode to climb his way to 5th at the finish. He ranked 2nd in the final championship standings.

We can place our great hopes on him next year.



Garriga made the 250 championship series very exciting.

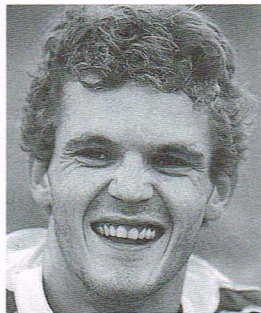

J. Garriga

- 5. C. Cardus Honda
- 6. I. Palazzese Yamaha

14th round - Czechoslovakia - August 28 500cc class

- 1. W. Gardner Honda
- 2. E. Lawson Yamaha
- 3. W. Rainey Yamaha
- 4. P-F. Chili Honda
- 5. T. Taira Yamaha
- 6. N. McKenzie Honda

250cc class

- 1. J. Garriga Yamaha
- 2. A. Pons Honda
- 3. L. Cadalora Yamaha
- 4. L. Reggiani Aprilia
- 5. C. Cardus Honda
- 6. R. Roth Honda

Argentina GP was cancelled

15th round - Brazil - Sept. 17 500cc class

- 1. E. Lawson Yamaha
- 2. W. Gardner Honda
- 3. K. Schwantz Suzuki
- 4. N. McKenzie Honda
- 5. C. Sarron Yamaha
- 6. K. Magee Yamaha

250cc class

- 1. D. Sarron Honda
- 2. C. Lavado Yamaha
- 3. A. Pons Honda
- 4. R. Roth Honda
- 5. J. Garriga Yamaha

FINAL CHAMPIONSHIP POSITIONS

500cc class

- 1. E. Lawson Yamaha .252 pts.
- 2. W. Gardner Honda .229 pts.
- 3. W. Rainey Yamaha .189 pts.
- 4. C. Sarron Yamaha .149 pts.
- 5. K. Magee Yamaha .138 pts.
- 6. N. McKenzie Honda .125 pts.
- 7. D. De Radigues Yamaha .120 pts.

250cc class

- 1. A. Pons Honda .231 pts.
- 2. J. Garriga Yamaha .221 pts.
- 3. J. Cornu Honda .166 pts.
- 4. D. Sarron Honda .158 pts.
- 5. R. Roth Honda .158 pts.
- 6. L. Cadalora Yamaha .136 pts.
- 7. J-P Ruggia Yamaha .104 pts.

WORLD CHAMPIONSHIP MOTOCROSS

125cc class

11th round - Finland - August 14

- Overall
- 1. D. Strijbos Cagiva
 - 2. J-M Bayle Honda
 - 3. M. Healy Cagiva
 - 4. P. Tragter Honda
 - 5. M. Kouki Yamaha

12th round - Switzerland - August 28

- Overall
- 1. J-M. Bayle Honda
 - 2. D. Strijbos Cagiva
 - 3. B. Moore KTM
 - 4. P. Demaria Yamaha
 - 5. A. Puzar KTM

FINAL CHAMPIONSHIP POSITIONS

- 1. J-M. Bayle Honda .398 pts.
- 2. D. Strijbos Cagiva .395 pts.
- 3. P. Tragter Honda .226 pts.
- 4. A. Puzar KTM .181 pts.
- 5. M. Healy Cagiva .156 pts.
- 6. M. Contini Cagiva .156 pts.

250cc class 10th round - Venezuela - August 7

- Overall
- 1. P. Vehkonen Cagiva
 - 2. Y. Kervella Honda
 - 3. J. Van den Berk Yamaha
 - 4. G-J Van Doorn Cagiva
 - 5. M. Fanton Yamaha
 - 6. S. Mortensen Kawasaki
 - 6. P. Johansson Yamaha

11th round - Argentina - August 14

- Overall
- 1. G. Andreani Honda
 - 2. R. Ryan Honda
 - 3. P. Vehkonen Cagiva
 - 4. M. Fanton Yamaha
 - 5. R. Smith Suzuki
 - 6. R. Herring Yamaha

12th round - Sweden - August 28

- Overall
- 1. G-J Van Doorn Cagiva
 - 2. J. Van den Berk Yamaha
 - 2. P. Vehkonen Cagiva
 - 4. J. Nilsson Cagiva
 - 5. S. Mortensen Kawasaki
 - 6. R. Herring Yamaha

FINAL CHAMPIONSHIP POSITIONS

- 1. J. Van den Berk Yamaha .315 pts.
- 2. P. Vehkonen Cagiva .285 pts.
- 3. R. Smith Suzuki .230 pts.
- 4. G-J. Van Doorn Cagiva .225 pts.
- 5. J. Whatley Suzuki .194 pts.
- 6. S. Mortensen Kawasaki .170 pts.

500cc class

11th round - Belgium - August 7

- Overall
- 1. H. Carlqvist Kawasaki
 - 2. M. Banks Honda
 - 3. K. Nicoll Kawasaki
 - 4. K. Van der Ven KTM
 - 5. K. Ljungqvist Yamaha

12th round - Luxembourg - August 14

- Overall
- 1. K. Nicoll Kawasaki
 - 2. J. Vimond Yamaha
 - 2. H. Carlqvist Kawasaki
 - 4. D. Geukens Kawasaki
 - 4. B. Liles Kawasaki

FINAL CHAMPIONSHIP POSITIONS

- 1. E. Geboers Honda .333 pts.
- 2. K. Nicoll Kawasaki .312 pts.
- 3. D. Thorpe Honda .251 pts.
- 4. K. Van der Ven KTM .212 pts.
- 5. J. Vimond Yamaha .185 pts.
- 6. K. Ljungqvist Yamaha .169 pts.

WORLD CHAMPIONSHIP MOTOCROSS 250cc CLASS

Yamaha rider John Van den Berk, who rode a modified Yamaha YZ250 in the '88 250cc World Championship Motocross Series, captured his first 250cc title when he rode his Yamaha machine to third place in the first race of the Swedish GP, the 12th and final round of the series held at Tibro on August 28. This also brought Yamaha the '88 Manufacturers title.

In the 1st race of the title-deciding round, Van den Berk, Pekka Vehkonen (Cagiva) and G-J. Van Doorn (Cagiva) fought clear of the rest of the pack. But the Yamaha man knew just what he had to do to clinch the title and settled for a safe, championship-winning third place.

It was the same story in race 2, with the new champion taking se-

Van Den Berk wins his first championship, bringing Yamaha the manufacturer's title

cond when Vehkonen fell three laps from the finish.

"One of the main factors in my success has been the strength of the team and the consistency it has helped me maintain," said the new champion, "The bike was to-

tally reliable and that meant I could start every race knowing that I only had to worry about doing my best. I had total confidence that the Yamaha would not let me down."

RESULTS

WORLD CHAMPIONSHIP ROAD RACING

12th round - U.K. - August 7

500cc class

- 1. W. Rainey Yamaha
- 2. W. Gardner Honda
- 3. C. Sarron Yamaha
- 4. N. McKenzie Honda
- 5. K. Magee Yamaha
- 6. E. Lawson Yamaha

250cc class

- 1. L. Cadalora Yamaha

- 2. D. Sarron Honda
- 3. J. Garriga Yamaha
- 4. A. Pons Honda
- 5. R. Roth Honda
- 6. J-P Ruggia Yamaha

13th round - Sweden - August 14 500cc class

- 1. E. Lawson Yamaha
- 2. W. Gardner Honda
- 3. C. Sarron Yamaha
- 4. N. McKenzie Honda
- 5. W. Rainey Yamaha
- 6. K. Magee Yamaha

250cc class

- 1. A. Pons Honda
- 2. J. Garriga Yamaha
- 3. D. Sarron Honda
- 4. R. Roth Honda

SUPERBIKE WORLD SUPERBIKE CHAMPIONSHIP SERIES

5th round at Sugo

Goodfellow (Suzuki) & Doohan (Yamaha) split hard-won victories

Raised this year to the status of World Championship, the Superbike series entered its fifth round at the Sugo circuit on August 28. Yamaha rider Michael Doohan (FZR750R), came out the victor in the 2nd 25-lap heat of this 2-heat competition. The 1st heat was taken by Gary Goodfellow (Suzuki) who was the only rider to replace wet tires with cut-slick ones to accommodate for a change in course conditions halfway through the race.

In the 5th lap of the rain-drenched 1st race, Goodfellow continued to lead the race in almost a runaway style until he made a pit-stop on lap 14. Kunio Machii (FZR750) dashed into the lead during Goodfellow's pit-stop but only two laps from the finish he ran off the course and retired. Michael

Doohan fought his way on to 3rd after crashing in the opening lap. But he was forced to retire as he crashed once again in the 22nd lap. Another FZR750R rider Michael Dowson retired in the 14th lap. The 2nd 25-lap heat was run under dry course conditions.

Italian rider Marco Lucchinelli (Ducati) streaked into the lead just after the start. Closely following him were Fabrizio Pirovano (FZR750R), Dowson, Robert Phillis (Kawasaki), Virginio Ferrari (Honda) and Goodfellow.

Both Lucchinelli and Dowson crashed while leading the pack into the S-type bend in the 3rd lap. And the race was suspended as Dowson's Yamaha went up in flames. In the restarted race, Pirovano held top po-

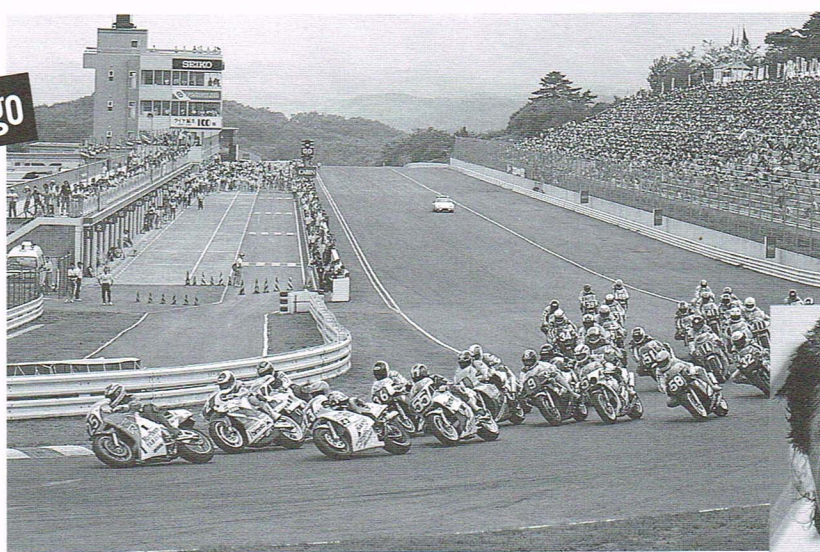

M. Doohan

sition until Doohan pulled ahead in the 2nd lap. Showing top form, Doohan increased his lead lap by lap despite tough challenges from Iwahashi, Phillis, Ferrari and Goodfellow.

Doohan finished first to record his first championship win, Goodfellow placed 3rd about 4 seconds behind Iwahashi. Machii retired after crashing in an opening-stage melee.

RESULTS

1st heat

- 1. Gary Goodfellow (Suzuki GSX-R750) 45' 50 980
- 2. Fred Merkel (Honda RC30) 46' 18 560
- 3. Yukiya Oshima (Suzuki GSX-R750) 46' 30 940
- 4. Stephane Mertens (Bimota YB4) 46' 35 080
- 5. Mitsuaiki Watanabe (Yamaha FZR750) 46' 37 340

2nd heat

- 1. Michael Doohan (Yamaha FZR750R) 41' 41 570
- 2. Kenichiro Iwahashi (Honda VFR750R) 41' 48 500
- 3. Gary Goodfellow (Suzuki GSX-R750) 41' 52 340
- 4. David Tardozzi (Bimota YB4) 41' 57 070
- 5. Edwin Weibel (Honda RC30) 41' 59 280

U.S. Golfcar dealers meet in Yamaha's new home state, Georgia

From July 21 to 23, Yamaha's Golfcar Dealers met in Georgia for their annual conference. The site was the 1200-acre Stouffer Pine Isle Resort, a 4-star resort with forests, beaches and an 18-hole golf course on one enchanting island.

In addition to sales and marketing seminars at the resort, the focus of the meeting was the new Yamaha Motor Manufacturing Plant in Newnan, Georgia, located 30 minutes south of Atlanta. A full day was devoted to a "grand tour" of the new Yamaha USA plant.

Some of the world's most advanced mass production approaches and manufacturing equipment were observed in full operation. Along with the outstanding reception, including a live band and welcoming speeches, was the traditional Sake barrel opening ceremony held at the new facility. Joining in the celebration from YMC was Sr. Managing Director Mr. T. Hasegawa, and Director Mr. N. Shiokawa. Hosting the dealers from YMUS and YMMC were Presidents Mr. B. Watanabe and Mr. S. Shimamoto.



The YMMC plant that went into operation in June of this year. Golfcar dealers made a study-tour through the plant.

Answering the boom in marine leisure with 11 models in 20 variations

Announcing new boats for the '89 Japanese market

Testrides are also given along with the unveiling of new boats.

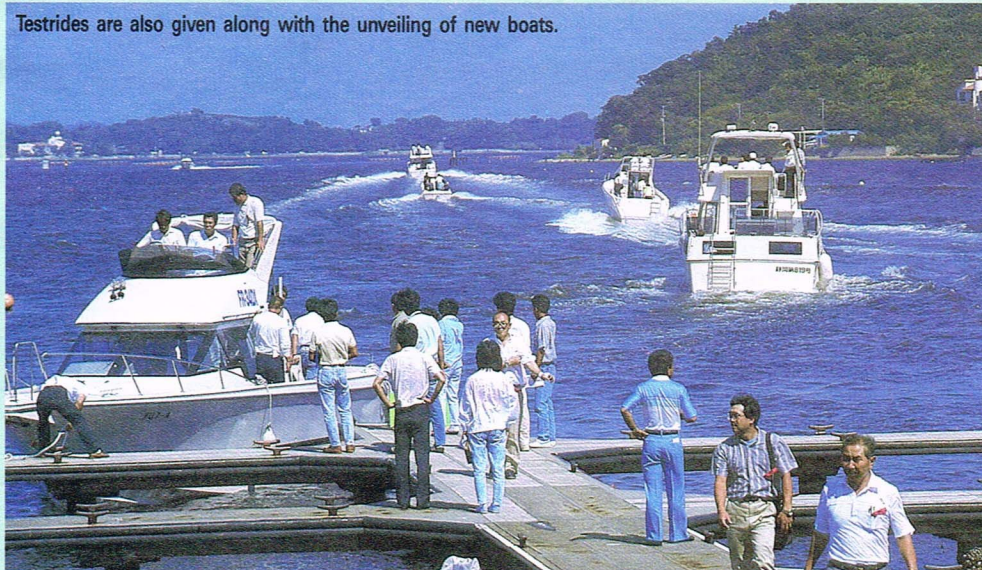

Yamaha Motor kicked off the '89 marine season with the introduction of a total of 11 new models, including 3 powerboats, 6 fishing boats and 2 sailboats, that went on sale as of September 10.

Japan is now enjoying a boom in marine leisure sports such as pleasure motorboating and sailing, and along with this boom has come a diversification and individualization in user needs in the market.

To accommodate this new growth, plans are underway to build a total of 370 new public and private harbors and about 800 new public mooring facilities in Japan by the year 2000.

The recently released Yamaha models have been developed to reflect the new spectrum of user needs featuring in addition to Yamaha's proven performance qualities a new level of refinement in livability and greater attention to equipment and appointment quality. These models bring even greater variety and coloring to the existing line-up, and offer the user a richer range of choices.

Prior to the market debut, a press conference and testrides were held at Yamaha Marina Hamanako on Sept 6 and 7. The scale of the current marine leisure boom was apparent once again in the fact that, in marine journalists alone, there were over 40 people present for the event.



The Yamaha SC-38 (new model)

Developed as the top-of-the-line production model in Yamaha's powerboat line, aimed at the growing market in large-size boats. This is the first Yamaha to feature a 3-room cabin layout. Other features include a large flying bridge, a lounge-style main saloon, two high-performance diesel engines and an AC 100V electric generator.



Golfcar testrides are one of the most enjoyable programs for the dealers. Pictured here is the new G5 Golfcar.

92 Yamaha dinghies for national championships

The first Japanese "Kokutai" (National Sports Festival) held in Kyoto in 1946 was an event conceived for the purpose of raising people's spirits, while also contributing to the spread of interest in sport.

Taking the form of an inter-prefectural competition, this event has grown in popularity over the years to become one of the biggest events in Japan today from the aspect of sports promotion.

In terms of the number of sports contested, it is similar in scope to the Olympics.

Now in its 43rd year, the '88 meet has

a special significance for YMC. As of this year the yacht competition included a new "Seahopper Class" contested with 14ft. Yamaha Y14 II dinghies. Until now the yachting has included 470 class, Snipe class and FJ class competitions, but in order to give more people a chance to participate, an additional class in which a competitor can only take part once was conceived. And, the "Seahopper" was chosen as the boat to be used.

As a result, for four days beginning September 4, sailors from all the prefectures tested their skill and strength on 92 Yamaha Seahoppers.

