



**YAMAHA**

**IT125H**

**OWNER'S  
SERVICE MANUAL**



**YAMAHA MOTOR CO.,LTD.**

IWATA, JAPAN

PRINTED IN JAPAN  
80-6-1.5x1 Op

LIT-11626-02-53

3R9-28199-11



## IMPORTANT NOTICE

THIS MOTORCYCLE IS DESIGNED STRICTLY FOR OFF-ROAD RIDING USE ONLY. IT IS ILLEGAL TO OPERATE THIS VEHICLE ON PUBLIC STREETS, ROADS, AND HIGHWAYS. PLEASE CHECK LOCAL RIDING LAWS AND REGULATIONS BEFORE OPERATING THIS VEHICLE.

### SAFETY WARNINGS:

1. **GASOLINE IS HIGHLY FLAMMABLE:**
  - \* Always turn off the engine when refueling.
  - \* Take care not to spill on the engine or exhaust pipe/muffler, when refueling.
  - \* If any gasoline spills on the engine or exhaust pipe/muffler, wipe it off immediately.
  - \* Never refuel while smoking or in the vicinity of an open flame.
2. If you should swallow some gasoline or inhale a lot of gasoline vapor, or allow some gasoline to get in your eye(s), see your doctor immediately. If any gasoline spills on your skin or clothing, immediately wash it with soap and water, and change your clothes.
3. When parking the machine, note the followings:
  - \* The engine and exhaust pipe/muffler are heated up. Park the machine in a place where pedestrians or children are not likely to touch the machine.
  - \* Do not park the machine on a slope or soft ground; the machine can easily overturn.
4. When transporting the machine in another vehicle, be sure it is kept upright and that the fuel petcock is turned to the "OFF" position. If it should lean over, gasoline may leak out of the carburetor or fuel tank.
5. Never start your engine or let it run for any length of time in a closed area. The exhaust fumes are poisonous and can cause loss of consciousness and death within a short time. Always operate your machine in an area with adequate ventilation.
6. Always wear a helmet, gloves, boots, trousers and jacket for off road riding.

Lee Waldie Craig Scott Chris Koira

IT125H  
Owner's Service Manual  
© Yamaha Motor Corporation, U.S.A., 1980  
1st Edition, June 1980  
All rights reserved, Any reprinting or  
unauthorized use without the written  
permission of Yamaha Motor Corporation,  
U.S.A., is expressly prohibited.  
Printed in Japan  
LIT-11626-02-53



## INTRODUCTION

Congratulations on your purchase of the Yamaha IT125G. This model represents the product of many years of Yamaha experience in the production of fine sporting, touring, and pace-setting racing machines. You can now appreciate the high degrees of craftsmanship and reliability that have made Yamaha a leader in these fields.

This manual will provide you with a good basic understanding of features, operation, and basic maintenance and inspection items of this vehicle. PLEASE READ THIS MANUAL CAREFULLY AND COMPLETELY BEFORE OPERATING YOUR NEW MACHINE. If you have any questions regarding the operation or maintenance of your machine, please consult your Yamaha dealer.

Particularly important information is distinguished in this manual by the following notations:

**NOTE:** . . . . . A NOTE provides key information to make procedures easier or clearer.

**CAUTION:** . . . . A CAUTION indicates special procedures that must be followed to avoid damage to the machine.

**WARNING:** . . . . A WARNING indicates special procedures that must be followed to avoid injury to a machine operator or person inspecting or repairing the machine.

**NOTICE:**

Some data in this manual may become outdated due to improvements made to this model in the future. If there is any question you have regarding this manual or your machine, please consult your Yamaha dealer.

SERVICE DEPT.  
INTERNATIONAL DIVISION  
YAMAHA MOTOR COMPANY, LTD.

## CONTENTS

GENERAL INFORMATION . . . . .	1
MACHIN IDENTIFICATION . . . . .	1
CONTROL FUNCTION . . . . .	1
FUEL AND OIL . . . . .	4
PRE-OPERATION CHECKS . . . . .	5
STARTING AND OPERATION . . . . .	5
PERIODIC MAINTENANCE AND ADJUSTMENT . . . . .	6
MAINTENANCE AND LUBRICATION SCHEDULE CHART . . . . .	6
SPECIAL TOOL . . . . .	10
ADJUSTMENTS . . . . .	11
MAINTENANCE AND MINOR REPAIRS . . . . .	19
ENGINE . . . . .	19
CHASSIS . . . . .	36
ELECTRICAL . . . . .	45
MISCELLANEOUS . . . . .	48
TROUBLE SHOOTING GUIDE . . . . .	48
CLEANING AND STORAGE . . . . .	48
SPECIFICATIONS . . . . .	50
CABLE ROUTING DIAGRAM . . . . .	55
WARRANTY INFORMATION . . . . .	57



# GENERAL INFORMATION

## MACHINE IDENTIFICATION

### Frame serial number

The frame serial number is stamped on the right side of the steering head stock.

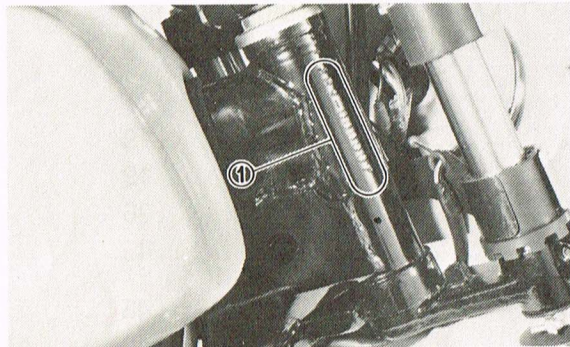

1. Frame serial number

### Engine serial number

The engine serial number is stamped into the raised part of the right rear section of the engine.

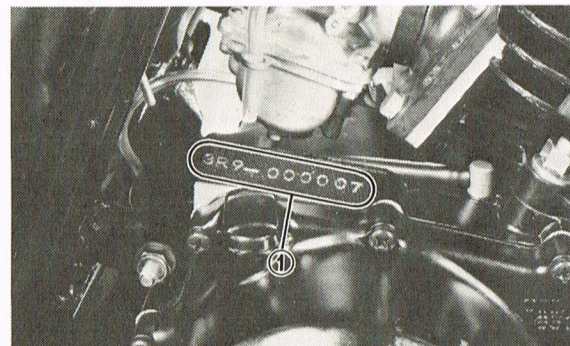

1. Engine serial number

### NOTE:

The first three digits of these numbers are for model identifications; the remaining digits are the unit production number. Keep a record of these numbers for reference when ordering parts from your Yamaha dealer. In case of theft, the authorities will need these numbers and your model name for identification.

## CONTROL FUNCTIONS

### WARNING:

1. Before riding this motorcycle, become thoroughly familiar with all operating controls and their function. Consult your Yamaha dealer regarding any control or function you do not thoroughly understand.
2. Observe the break-in procedures to preclude mechanical failures.
3. This model is designed for OFF ROAD use only. It is not equipped with highway approved lighting, mirrors, horn or directional signals. In most instances, it is illegal to ride this model (either day or night) on any public street or highway.

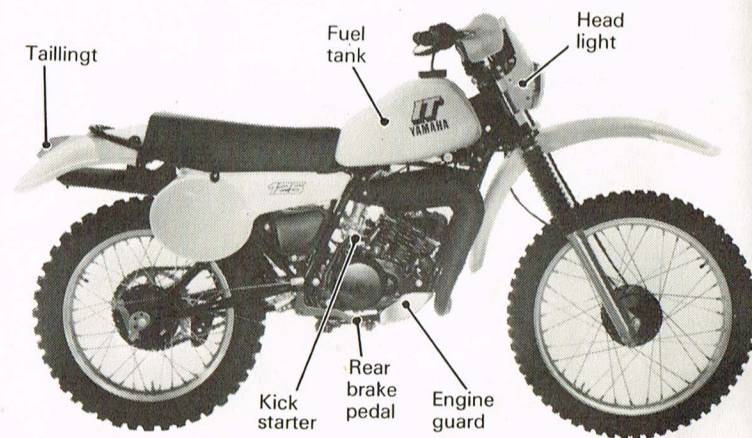

### Kick starter

To start the engine, rotate the kick crank, push down lightly with foot until gears engage, and then kick with full strength. This model has the primary kick starter so the engine can be started in any gear if the clutch is disengaged. As normal practice, however, shift to neutral before starting.

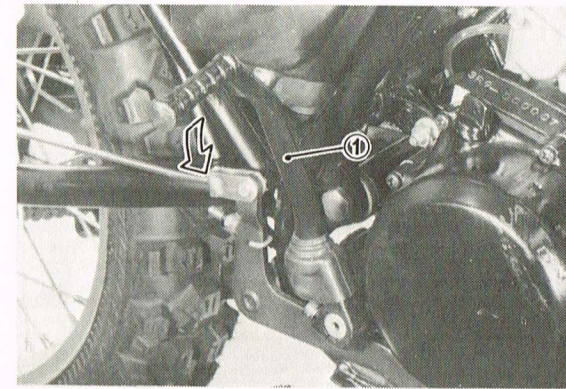

1. Kick starter

### Rear brake pedal

Press down on the brake pedal to activate the rear brake.

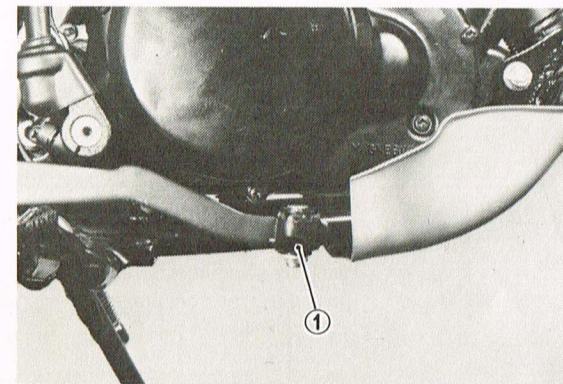

1. Rear brake pedal

### Starter lever

For starting a cold engine, push lever down to open the jet. Never ride the machine with the lever down.

### Special wrench.



### Fuel petcock

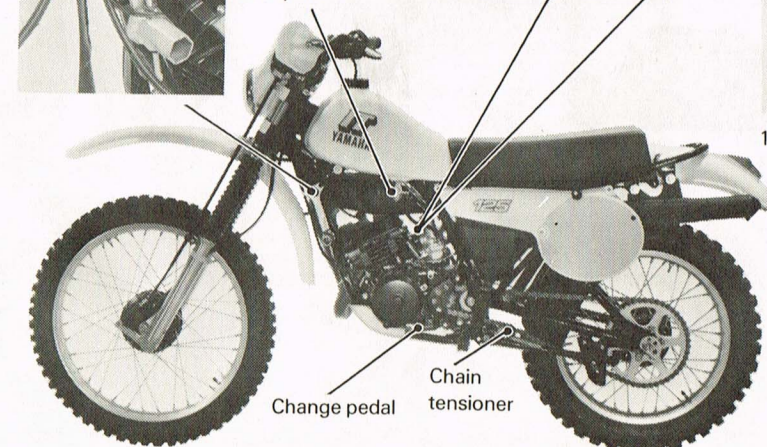
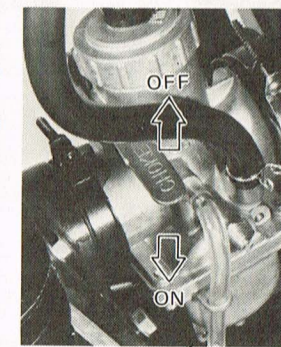

### Fuel petcock

OFF: Fuel will not flow. Always return the lever to this position when the engine is not running.

ON: Fuel flow to the carburetor. Normal riding is done with the lever in this position.

RES: This indicates "RESERVE". If you run out of fuel while riding, move the lever to this position. THEN, FILL THE TANK AT THE FIRST OPPORTUNITY.



### Change pedal

The gear ratios of the constant mesh 6-speed transmission are ideally spaced. The gears can be shifted by using the change pedal.

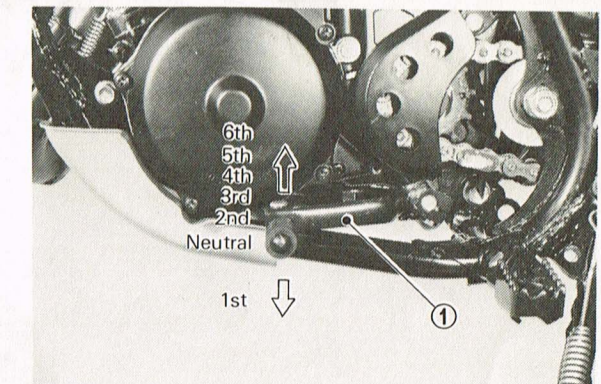

1. Change pedal



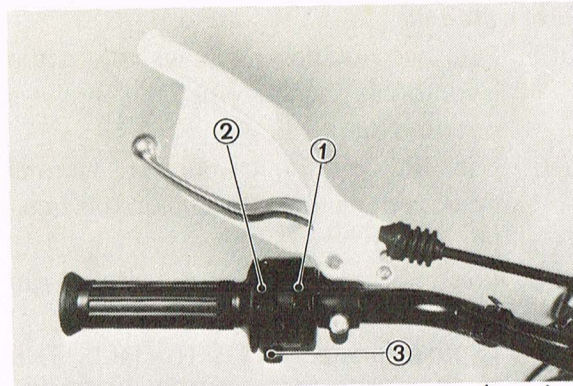

1. Lighting switch  
If the light switch is turned forward, headlight and tail-light come on.
2. Dimmer switch  
Turn to the "H" position for high beam and to "L" position for low beam.
3. Engine stop button  
Push and hold to stop engine.

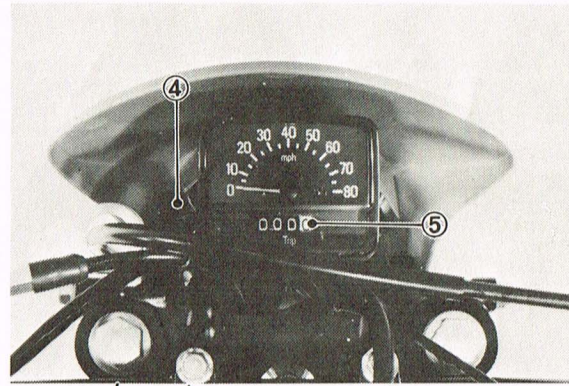

4. Reset knob
  - a. Turn the knob clockwise for resetting the entire place numbers to zeros.
  - b. Pull the knob and turn it either way for place-by-place reading adjustment.
5. Trip odometer

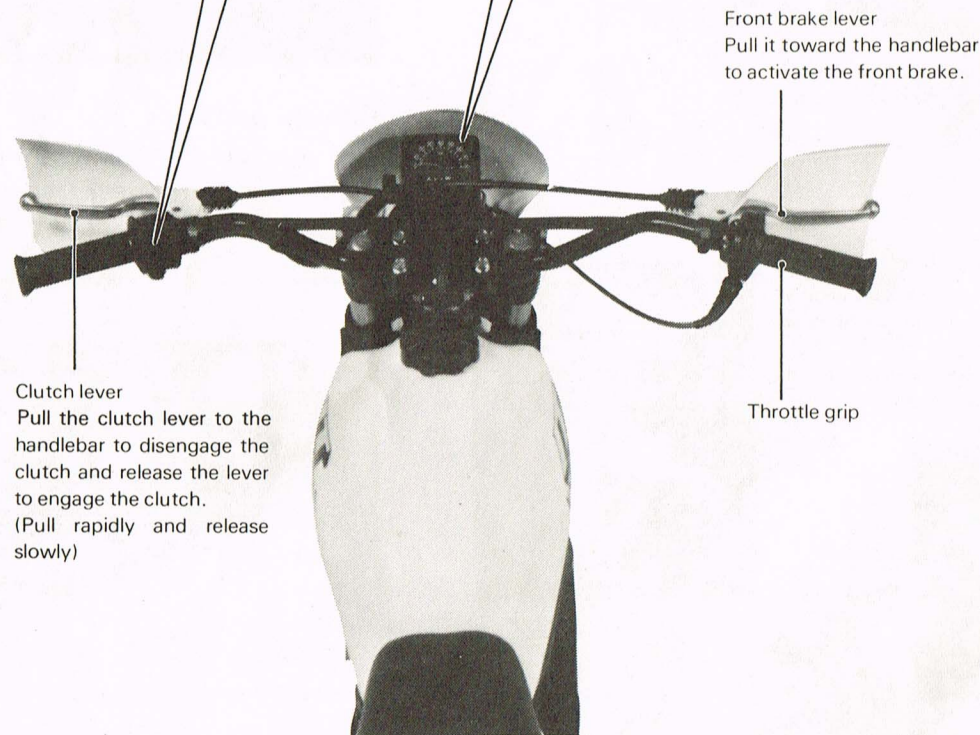

**Clutch lever**  
Pull the clutch lever to the handlebar to disengage the clutch and release the lever to engage the clutch.  
(Pull rapidly and release slowly)

**Front brake lever**  
Pull it toward the handlebar to activate the front brake.

**Throttle grip**

## FUEL AND OIL

### Fuel

Use premium gasoline with an octane rating of 90+ mixed with oil at a gas/oil ratio specified below. Always use fresh, namebrand gasoline. Always mix a fresh batch of fuel the morning of the race and do not retain a mixed batch overnight.

Fuel tank capacity: 8.5 lit (2.2 US. gal)

### Engine oil

We recommend that your first choice be Yamalube Racing 2-cycle oil. If for any reason you should use another type select from the following list.

- \* Shell Super M (Vegetable base)
- \* Castrol R 30 (Vegetable base)

Mixing ratio: 20 : 1

### Transmission oil

Recommended oil:  
Yamalube 4-cycle oil or  
SAE 10W/30 "SE" motor oil

### OIL REPLACEMENT

To drain the oil, warm the engine up and remove the drain plug and drain all transmission oil. Reinstall the drain plug (make sure it is secure). Add oil through the hole.

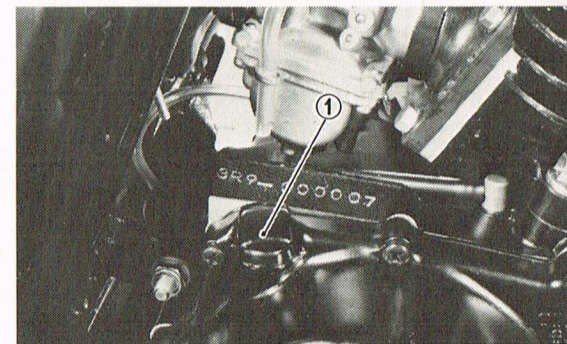

1. Filler plug

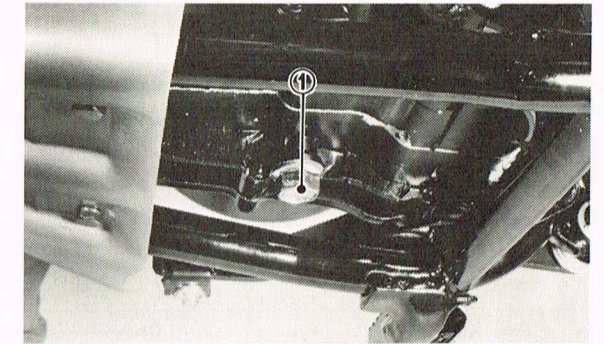

1. Drain plug

Transmission oil capacity:

Periodic oil change:

650 ± 50cc (0.69 ± 0.05 US. qt)

Overhaul:

750 ± 50cc (0.80 ± 0.05 US. qt)

### OIL LEVER CHECK

On the right side of the engine there is a checking screw. To check, warm up the engine for 2 ~ 3 minutes. Place the motorcycle upright and remove the oil level checking screw. If oil flows out, the oil level is correct.

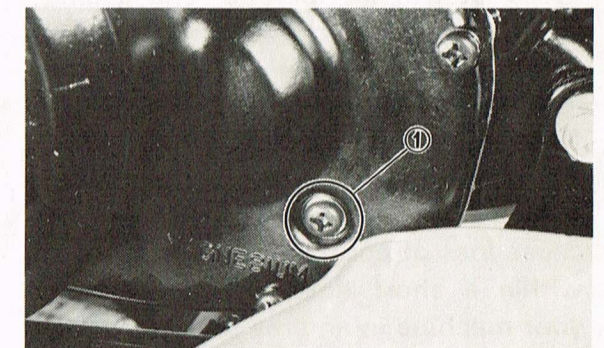

1. Checking screw

### CAUTION:

Do not add any chemical additives. Transmission oil also lubricates the clutch and additives could cause the clutch to slip



## PRE-OPERATION CHECKS

ITEM	ROUTINE	PAGE
BRAKES	Check operation/adjustment	15
CLUTCH	Check operation/lever adjustment	14, 15
FUEL TANK	Fill with proper fuel/oil mix	4
TRANSMISSION OIL	Check oil level/Change oil as required	4
DRIVE CHAIN	Check alignment/adjustment/lubrication	16
SPARK PLUG	Check condition/clean or replace as required	11
THROTTLE	Check for proper cable operation	13
AIR FILTER	Foam type — must be clean and damp with oil always	13, 14
WHEELS & TIRES	Check pressure/runout/spoke tightness/axle nuts	18
FITTINGS/FASTENERS	Check all/tighten as necessary	—
LIGHTS	Check for proper operation	—

### NOTE:

Pre-operation check should be made each time machine is used. Such an inspection can be thoroughly accomplished in a very short time and the added safety it assures is more than worth the time involved.

## STARTING AND OPERATION

### CAUTION:

Prior to operating the machine, perform steps listed in pre-operation check list.

### WARNING:

Never start your engine or let it run for any length of time in a closed area. The exhaust fumes are poisonous and can cause loss of consciousness and death within a short time. Always operate your machine in an area with adequate ventilation.

### Starting a cold engine

- Shift transmission into neutral position.
- Turn the fuel petcock to "ON".
- Operate the carburetor starter lever (choke) and completely close the throttle grip.
- Kick the kick crank with full strength to start the engine.
- After the engine starts, warm up for one or two minutes. Make sure the starter lever (choke) is returned to the original position before riding.

### Starting a warm engine

Do not engage starter lever. Open throttle slightly. Engage the kick starter and start the engine.

### Warm-up

Run the engine at idle or slightly higher using the starter as required until the engine is warm. This procedure normally takes 1 to 2 minutes. To check, see if the engine responds normally to throttle with starter off.

### Engine break-in

- Prior to starting, fill tank with a break-in gasoline/oil mixture of 12:1 to 14:1.
- Allow engine to warm up. Check engine idling speed. Check operating controls and engine stop switch operation.
- Operate machine in lower gears at moderate throttle setting for 3~5 minutes. Check spark plug condition.
- Allow engine to cool. Repeat procedure, running for 5 minutes. Very briefly, shift to higher gears (4th or 5th) and check full throttle response. Check spark plug condition.

- Allow engine to cool. Repeat procedure, running for 5 minutes. Full throttle and higher gears may be used, but avoid sustained full throttle operation. Check spark plug condition.
- Allow engine to cool. Remove top end and inspect. Remove "high" spots on piston with No. 600 grit, wet sandpaper. Clean, and carefully reassemble.
- Remove break-in fuel/oil mixture from

tank. Refill with an mixture specified under "GAS/OIL MIXING RATIO". Check entire unit for loose or misadjusted fittings/controls/fasteners.

- Re-start engine and check through entire operating range thoroughly. Stop. Check spark plug condition. Re-start. After 10~15 minutes operation, machine is ready to race.

## PERIODIC MAINTENANCE AND ADJUSTMENT

### MAINTENANCE AND LUBRICATION SCHEDULE CHART

The maintenance and lubrication schedule chart should be considered strictly as a guide to general maintenance and lubrication intervals. You must take into consideration that weather, terrain, geographical locations, and a variety of individual uses all tend to demand

that each owner alter this time schedule to match his environment. For example, if the motorcycle is continually operated in an area of high humidity then all parts must be lubricated much more frequently than shown on the chart to avoid rust and damage. If you are in doubt as to how closely you can follow these time recommendations, check with the Yamaha dealer in your area.

Lee Waldie Craig Scott Chris Koira

### MAINTENANCE AND LUBRICATION SCHEDULE CHART

Item	Recommend lubricant	Every ride	Every 500 km	Every 1,500 km	Every race	As required
Piston Clean/Inspect Replace			○	○	(○)	
Piston ring Replace			○			
Cylinder head Inspect Clean/Retighten				○ ○	(○) (○)	
Cylinder Clean/Inspect Replace Retighten				○ ○	(○) (○)	○
Clutch Adjust Inspect Replace			○ ○		(○)	○



Item	Recommend lubricant	Every ride	Every 500 km	Every 1,500 km	Every race	As required
Transmission Change oil Inspect gears and shift fork Replace bearing	Yamalube 4-cycle oil or SEA 10W/30 "SE" motor oil		Initial (○)	○  (○)		○ ○
Engine main bearing Inspect				○		
Connecting-rod Inspect bearings Replace				○		○
Piston pin Inspect Replace				○		○
CDI rotor nut Retighten				○		
Kick starter Inspect idle gear Replace						○ ○
Exhaust system Inspect Cleaning		○		○		
Carburetor Inspect/ Adjust Clean/ Retighten				○ ○	(○) (○)	
Air filter Clean and lube Replace	Air filter must be cleaned and damp with oil after every ride. Do not over-oil. Use SAE 10W/30 motor oil.	○				○
Spark plug Inspect Replace		○				○
Drive chain Clean and lube  Check tension and alignment Replace	a. Yamaha chain and cable lube b. SAE 10W/30 motor oil	○  ○				○
Frame Clean/Inspect		○				
Fuel tank/petcock Clean				○		

Item	Recommend lubricant	Every ride	Every 500 km	Every 1,500 km	Every race	As required
Front fork Change oil Replace seal	Yamaha fork oil 15wt		Initial (○)	○		○
Rear shock absorber Inspect/ Adjust Lube	SAE 10W/30 motor oil	○	○		(○)	
Steering head Inspect Clean/ Lube Replace bearings	Medium-weight wheel bearing grease of quality manufacture (preferable water-proof)			○ ○		○
Swing arm Inspect Lube	Medium-weight wheel bearing grease of quality manufacture (preferable water-proof)			○ ○		
Chain guard Replace	Chain guard and tensioner					○
Wheels and tires Check pressure/ runout/ spoke tension Inspect bearings Lube oilseal Replace bearings		○ ○		○		○
Throttle Lube				○		
Control cables Routing (Connection) Inspect/ Lube	SAE 10W/30 motor oil	○ ○				
Clutch and brake lever pivot Lube/ Retighten	SAE 10W/30 motor oil	○				
Kick crank, Brake pedal Change pedal and foot rest pivot Lube Retighten	Lithium base grease SAE 10W/30 motor oil	○ ○				
Bolts and nuts Retighten		○				
Brake Clean/Inspect Lube/ Adjust Replace	Lithium base grease	○		○		○



## LUBRICATION

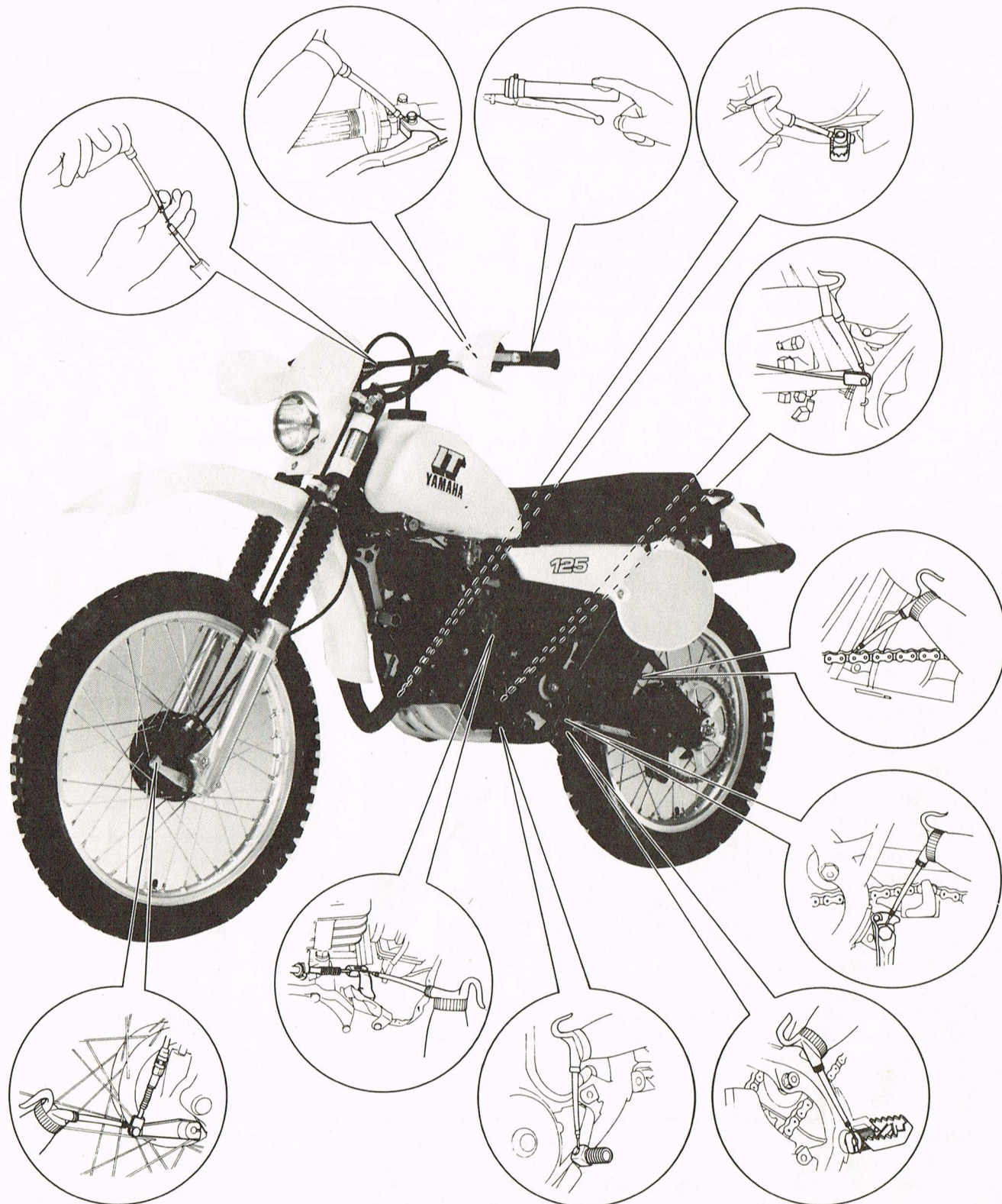

## SPECIAL TOOLS AND GAUGES

### NOTE:

The Research and Engineering Departments of Yamaha are continually striving to further perfect all models. Improvements and modifications are therefore inevitable. In light of this fact, the foregoing specifications are subject to change without notice to the owner. Information regarding significant changes is forwarded to all Authorized Yamaha Dealers as soon as available. If a discrepancy is noted, please consult you dealer.

 <p>90890-01235 Flywheel holding tool</p>	 <p>90890-01189 Flywheel puller</p>	 <p>90890-01022 Clutch holding tool</p>	 <p>90890-01135 Crankcase separating tool</p>
 <p>90890-01274 Crankshaft setting pot 90890-01275, 90890-01278 Crank installer bolt and adopter</p>	 <p>90890-01288 Spacer</p>	 <p>90890-01268 Steering nut wrench</p>	 <p>90890-03099 Dial gauge needle 90890-03097 Dial gauge</p>
 <p>90890-01195 Dial gauge stand</p>	 <p>90890-03104 Pocket tester</p>	 <p>90890-01212 Fork spring guide wrench</p>	



## ADJUSTMENT

### Spark plug

Standard spark plug:  
N-2G (Champion)

1. Measure the electrode gap with a wire thickness gauge.

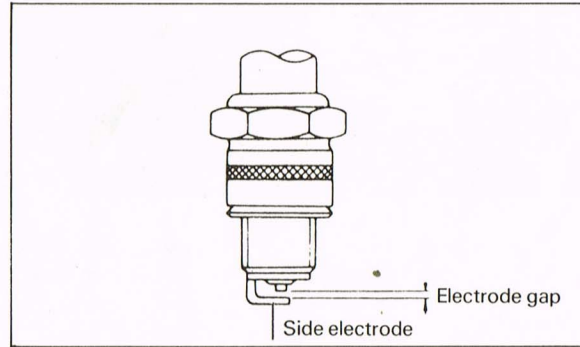

Adjustment can be made by bending the side electrode.

Electrode gap:  
0.6 ~ 0.8 mm (0.024 ~ 0.031 in)

When installing the plug, always clean the gasket surface and use a new gasket. Wipe off any grime from the threads and torque the spark plug properly.

Spark plug torque: 2.5 m·kg (18 ft·lb)

2. The insulator must be a medium-to-light tan color. If not, check carburetion, ignition timing and gas-oil mixing ratio. If the porcelain is a very dark brown or black color, then a plug with a hotter heat range may be required. This situation is quite common during the engine break-in period. However, use the standard plug. If the insulator tip shows a very light tan or white color or is actually pure white or if the electrodes show signs of melting, then a spark plug with a colder heat range is required.

### NOTE:

If a torque wrench is not available when you are installing a spark plug, a good estimate of the correct torque is 1/4 to 1/2 turns past finger tight. Have the spark plug torqued to the correct value as soon as possible with a torque wrench.

### Ignition Timing

#### 1. Checking

Ignition timing is checked with a timing light by observing the position of the mark stamped on the case and base and the mark on the rotor.

- a. Remove the crankcase cover (L).
- b. Connect the timing light to the spark plug lead wire.
- c. Start the engine and keep it running at the specified speed. Use a tachometer for checking.

Specified Speed: 2,000 r/min

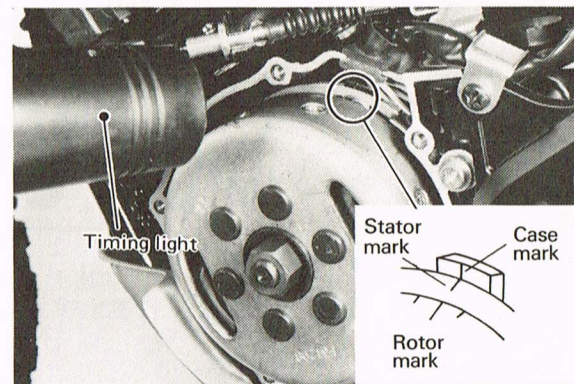

- d. While keeping the engine running at a specified speeds, check to see that the rotor mark aligns with the case mark and starter mark.

### 2. Adjustment

- a. Remove the flywheel magneto using the magneto holder and flywheel puller.

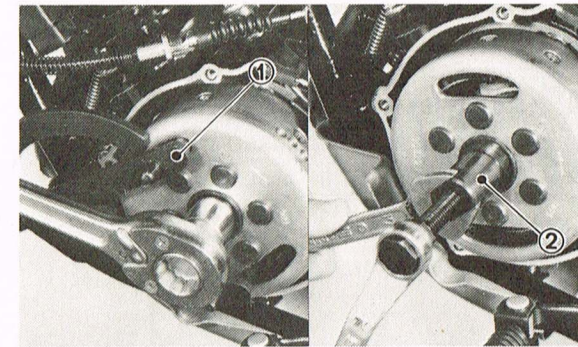

1. Flywheel holding tool (90890-01235) 1. Flywheel puller (90890-01189)

- b. Loosen the base set screws and turn the base right or left until the base mark aligns the case mark. Then tighten the base set screws.

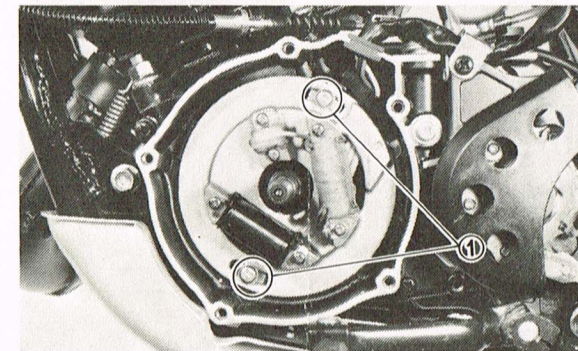

1. Base screw

- c. Reinstall the flywheel and tighten the nut.

Tightening torque:  
7.0 m·kg (50 ft·lb)

### 3. Marking of match mark

If a new crankcase is used, provide a match mark on it and proceed as follows:

- a. Remove muffler, spark plug and screw Dial Gauge Stand into spark plug hole.
- b. Insert Dial Gauge Assembly with a 56 mm (2.2 in) extension (needle) into stand.
- c. Remove left engine crankcase cover.
- d. Rotate rotor until piston is at top-dead center (T.D.C.). Tighten set screw on dial gauge stand to secure dial gauge as-

sembly. Set the zero on dial indicator face to line up exactly with dial indicator needle. Rotate flywheel back and forth to be sure that indicator needle not go past zero.

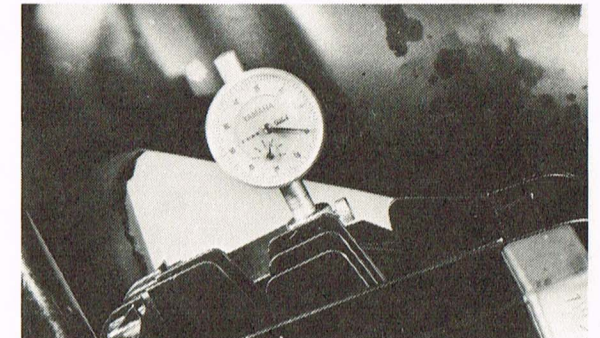

- e. Starting at TDC, rotate flywheel clockwise until dial gauge reads approximately 3 needle revolutions before-top-dead-center.
- f. Slowly turn flywheel counter-clockwise until dial gauge reads ignition advance setting listed in specifications table.

Ignition timing  
BTDC 18° at 2,000 r/min  
(-1.5 mm ± 0.15 mm)

- g. Provide a match mark on the crankcase matching the one on the flywheel.

### NOTE:

Be sure to locate the piston in the correct position before remarking.

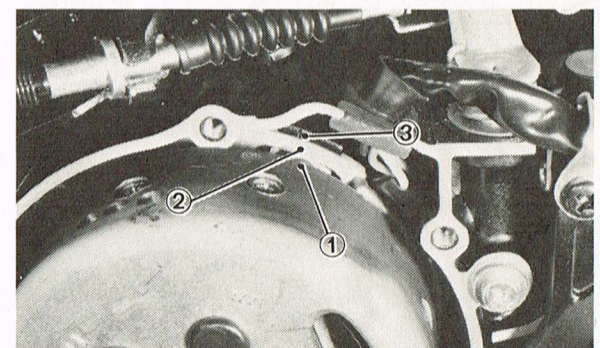

1. Flywheel mark 2. Base mark 3. Case mark

- h. Remove the dial gauge assembly and stand.
- i. Install the spark plug, muffler and crankcase cover.



### Throttle cable adjustment

Check play in turning direction of throttle grip. The play should be 3 — 5 mm (0.12 — 0.20 in) at grip flange, loosen the lock nut and turn the wire adjuster to make the necessary adjustment.

Tighten the adjuster lock nut.

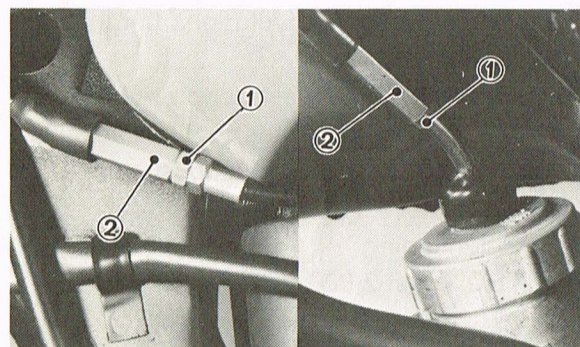
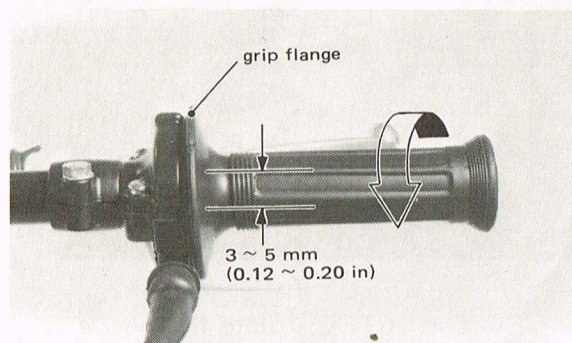

1. Lock nut 2. Adjuster

### Idle speed and idle air adjustments

1. Turn pilot air screw in until lightly seated.
2. Back out as specified.

Pilot air screw turns out: 1-3/4

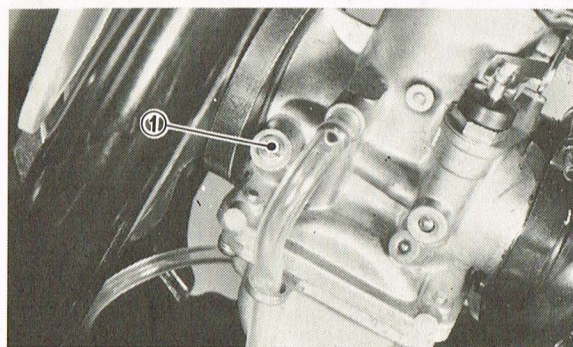

1. Pilot air screw

3. Turn the throttle stop screw until idle is at recommended speed.

### NOTE:

A lock nut is incorporated for positive retention of idle adjusting screw.

4. Turn the pilot air screw in or out until idle speed is at highest rpm.
5. Turn the throttle stop screw in or out until idle speed is at desired speed.

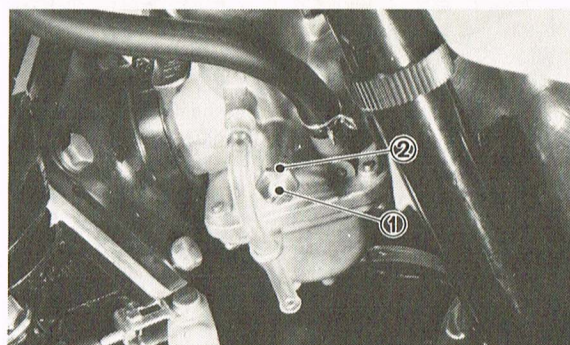

1. Throttle stop screw 2. Lock nut

### NOTE:

Pilot air and throttle stop screws should be so adjusted that engine response from idle position is rapid and without hesitation.

Idle speed: As desired

If the engine, when warm, hesitates after adjusting as described, turn the pilot air screw in or out in 1/4 turn increments until the problem is eliminated.

### Air Filter

#### Removal

1. Remove the Phillips-head screws (3) and remove filter case cover.



2. Remove the fitting plate and air filter from the filter case.

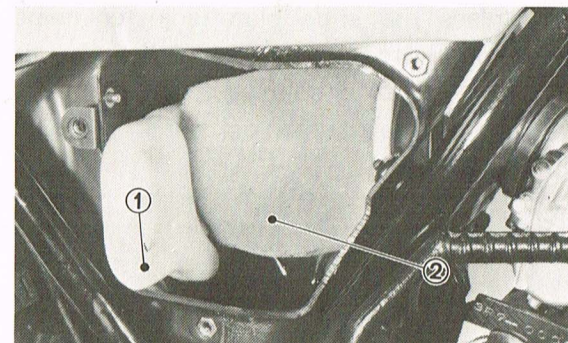

1. Fitting plate 2. Air filter

3. Slip the filter from the guide.



### Cleaning method

1. Wash the element gently, but thoroughly, in solvent.
2. Squeeze the excess solvent out of the element and let dry.
3. Pour a small quantity of 30W motor oil onto the filter element and work thoroughly into porous foam material.

### NOTE:

In order to function properly, the element must be damp with oil at all times, but not dripping with oil.

Lee Waldie Craig Scott Chris Koira

4. Re-insert the filter element guide into the element.
5. Coat the sealing edges of the filter element with light grease. This will provide an airtight seal between the filter case cover and filter seat.

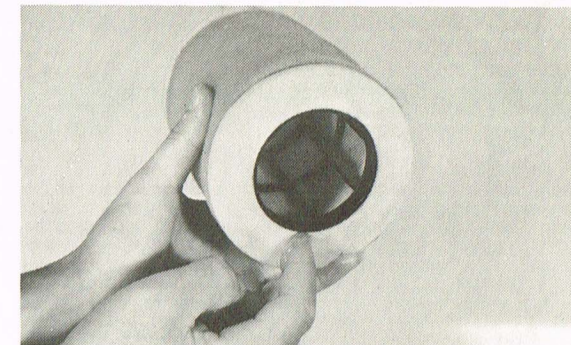

6. Reinstall the element assembly and parts removed for access.

### Clutch

#### Freeplay adjustment

1. Remove the adjuster cover and loosen the lock nut and turn the adjuster in on the lever holder.
2. Loosen the lock nut and turn the adjuster in or out on the clutch cable until the lever free play is achieved. If the proper free play is not achieved by turning the clutch cable adjuster, turn the lever holder adjuster in or out.
3. Tighten the lock nuts.

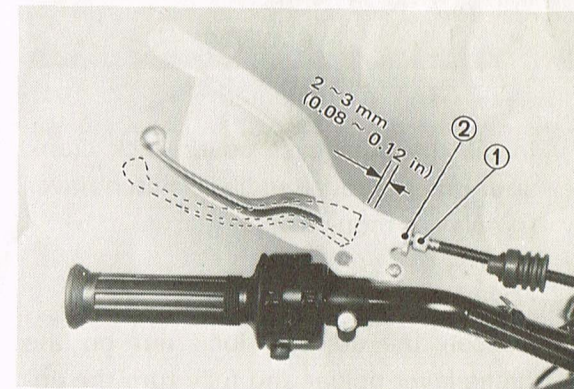

1. Adjuster 2. Lock nut

#### Mechanism adjustment

1. Fully loosen the cable in-line length adjuster lock nut and screw in the adjuster until tight.
2. Turn the handle lever adjuster in.
3. Remove the rear brake rod from lever. Remove kick crank.
4. Drain the transmission oil and remove the crankcase cover (R).
5. Loosen the clutch mechanism adjuster lock nut.



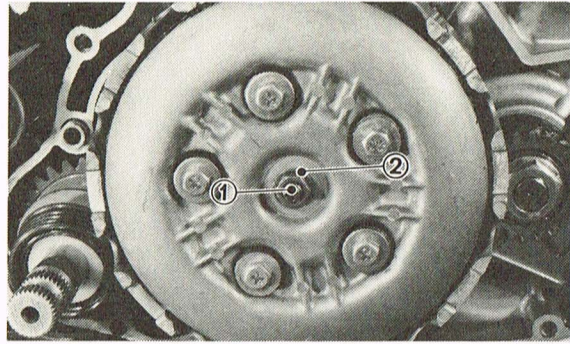

1. Adjuster 2. Lock nut

- Push the push lever toward the center of the engine with your finger until it stops. With the push lever in this position, turn the adjuster in or out until the push lever mark and crankcase match mark are aligned. Tighten lock nut.

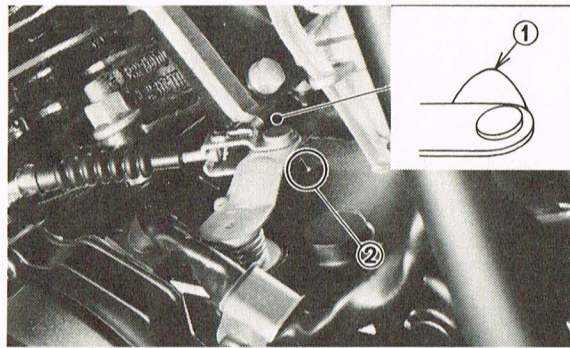

1. Push lever mark 2. Case match mark

- Install the crankcase cover, kick crank and brake rod. Readjust clutch lever freeplay as required.

### Front Brake

- Loosen the adjuster lock nut on the brake lever holder and fully turn the adjuster in.
- Loosen the lock nut on the shoe plate

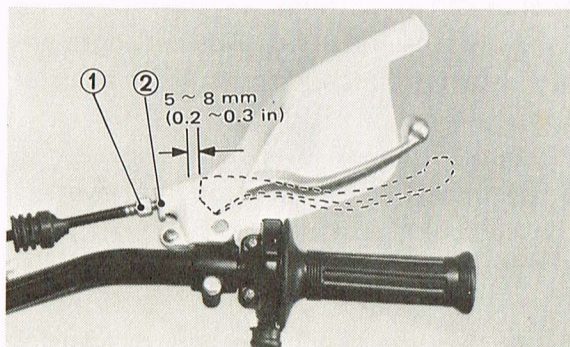

1. Adjuster 2. Lock nut

and turn the adjuster in or out until proper adjustment is achieved.

- Unless the shoe plate adjuster helps bring a proper play, adjust the play at the lever holder adjuster.
- Tighten the adjuster lock nut.

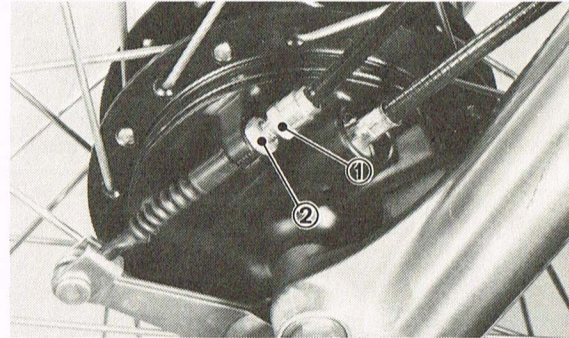

1. Adjuster 2. Lock nut

### Rear Brake

Adjust rear brake pedal play to suit, providing a minimum of 20 – 30 mm (0.80 – 1.2 in) freeplay. Turn the adjuster on the rear brake ferrule in or out brake pedal freeplay is suitable.

#### NOTE:

Rear brake pedal adjustment must be checked anytime chain is adjusted or rear wheel is removed and then reinstalled.

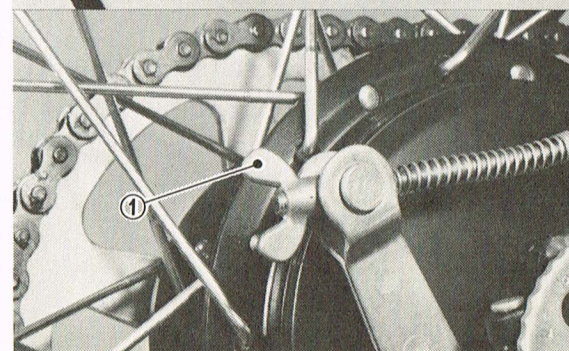
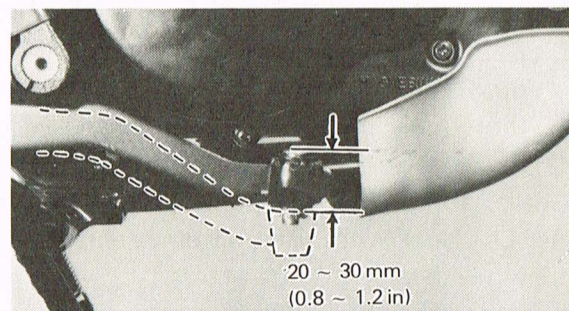

1. Adjuster

### Brake pedal position

The position of the rear brake pedal should be adjusted with relation to the foot rest. Loosen the lock nut and adjust the pedal height by turning the adjuster.

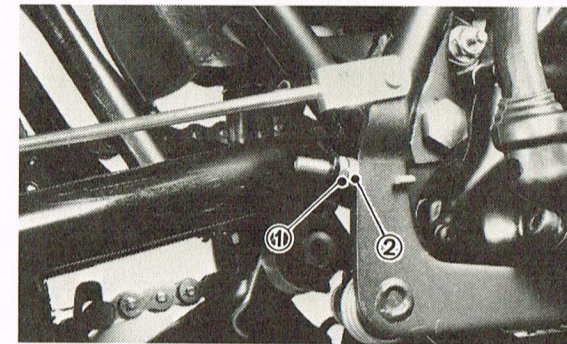

1. Lock nut 2. Adjuster

### Dive chain

To check the chain play, the motorcycle must stand vertically with its both wheels on the ground and without operator on it. Check the tension at the position shown in the illustration. The normal vertical deflection is approximately 40 – 45 mm (1.6 – 1.8 in). If the deflection exceeds 45 mm (1.8 in) adjust the chain tension.

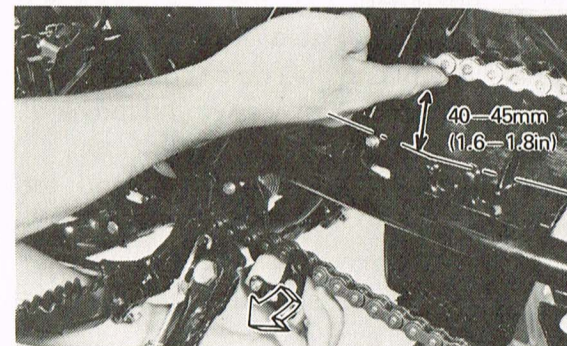

#### NOTE:

Tension inspection and adjustment should be made with the tensioner in the relaxed position (not touching the chain).

### Drive chain tension adjustment

- Loosen the rear brake adjuster
- Remove the rear axle cotter pin.
- Loosen the rear wheel axle nut.
- Turn chain puller both left and right, until axle is situated in same puller slot position on each side.

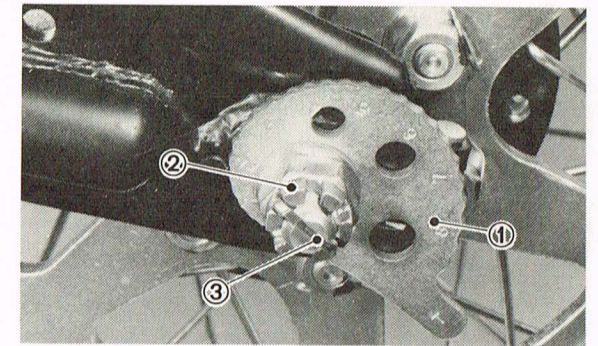

1. Chain puller 2. Axle nut 3. Cotter pin

#### NOTE:

Before adjusting, rotate rear wheel through several revolutions and check tension several times to find the tightest point. Adjust chain tension with rear wheel in this "tight chain" position.

- Tighten the rear axle nut.

Axle nut torque: 8.5 m·kg (60 ft·lb)

- Insert the new cotter pin into the rear wheel axle nut and bend the end of cotter pin. If the nut notch and pin hole do not match, tighten the nut slightly to match.

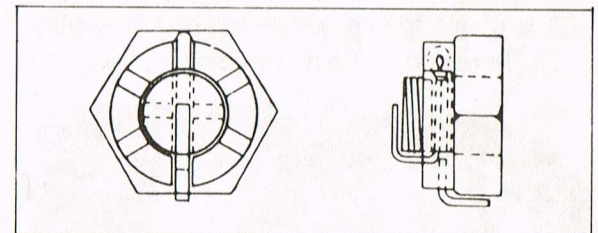

- In the final step, adjust the play in the brake pedal.

#### CAUTION:

Do not over tighten the chain. Excessive chain tension will overload the engine and other vital parts; Keep the tension within the specified limits. Also, replace the rear axle cotter pin with a new one.

### Fuel petcock inspection and cleaning

The fuel petcock has a built-in filter to remove any particles before they reach the carburetor. If the filter becomes blocked, the fuel cannot enter the carburetor. To prevent this, inspection and cleaning should be done at recommended intervals.



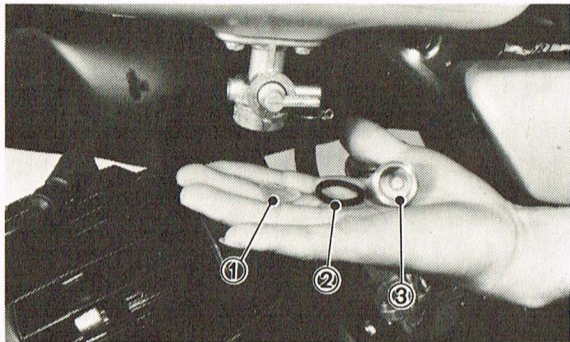

1. Filter screen 2. O-ring 3. Filter cup

1. First, turn the petcock lever to the "OFF" position; then remove the filter cup and clean the bottom of the cup with solvent.
2. After removing the filter cup, remove and clean the filter screen. At the same time, you should examine the condition of the O-ring. Replace if damaged.
3. When reassembling, be careful not to clamp the filter cup too tightly as this may cause the O-ring to become unseated, resulting in fuel leakage.

#### Steering Head

1. With front wheel elevated, grasp bottoms of fork legs and gently push and pull to check steering head freeplay. There should be no noticeable freeplay.



2. To adjust, first loosen upper stem pinch bolt.
3. Loosen stem bolt.
4. Use ring nut wrench to tighten adjusting nut.

#### CAUTION:

Forks must swing from lock to lock without binding or catching.

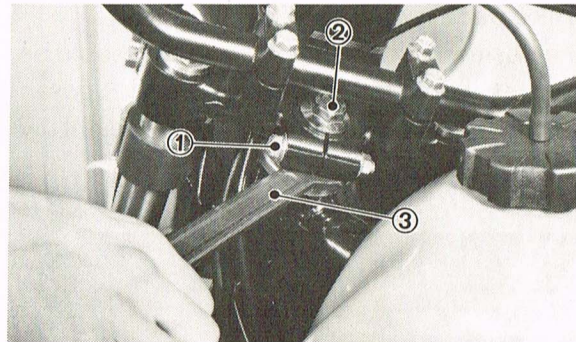

1. Pinch bolt 2. Stem bolt 3. Ring nut wrench

5. Tighten stem bolt and torque to specification.

Stem bolt torque:  
5.5 m-kg (40 ft-lb)

6. Tighten pinch bolts at fork crown and torque to specification.

Stem pinch bolt torque:  
2.4 m-kg (18 ft-lb)

#### NOTE:

Steering head disassembly must be performed by your Yamaha dealer.

#### Pear shock absorber adjustment

The spring pre-load of the rear shock absorber can be adjusted to suit rider preference, weight and the course conditions.

When springing feels excessive and too hard:

- Decrease the spring pre-load.

When bottoming feels excessive and too soft:

- Increase the spring pre-load.

To adjust, use the special wrench (in the owner's tool kit) as shown.

1. Remove the seat.

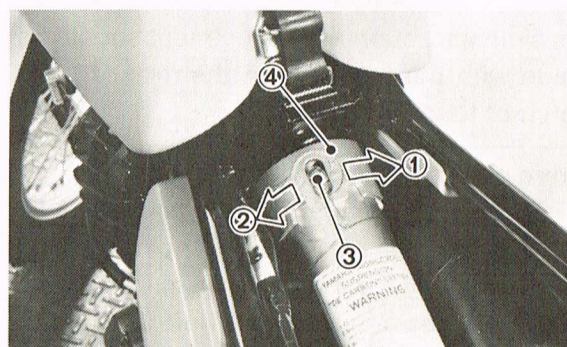

1. Stiffer 2. Softer 3. Adjuster stopper 4. Adjuster

2. Remove the adjuster stopper.
3. To increase pre-load, spring seat is raised.  
To decrease pre-load, spring seat is lowered.

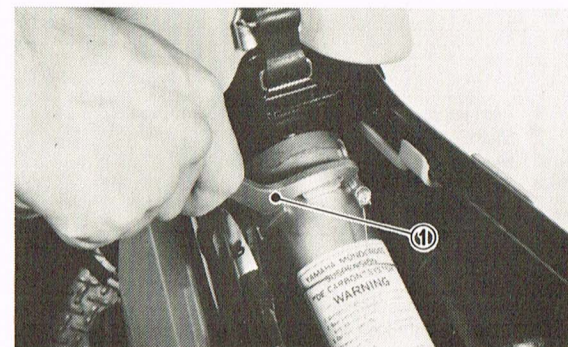

1. Special nut wrench

Adjusting Position	Soft				STD	Hard	
	4	3	2	1	•	1	2
Turn (s)	2	1-1/2	1	1/2	•	1/2	1

4. Tighten the adjuster stopper.
5. Install the seat and tighten the securing bolt.

#### Tire air pressure

Improper tire pressure affects the smoothness of the tire, traction, handling and the life of the tires. Always maintain the correct tire pressure.

Front: 1.0 kg/cm<sup>2</sup> (14 psi)

Rear: 1.0 kg/cm<sup>2</sup> (14 psi)

#### Check the spokes

If they are loose or bent, tighten or replace them. The spokes should be checked before each use.

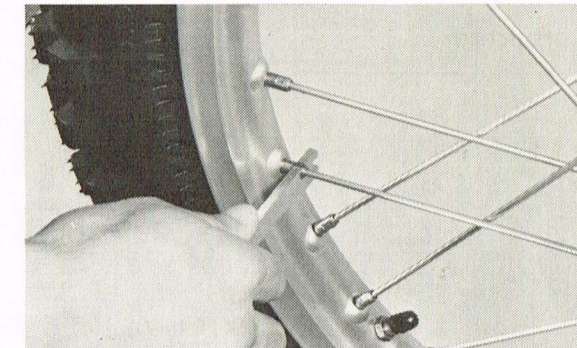



# MAINTENANCE AND MINOR REPAIRS

## ENGINE

### Carburetor

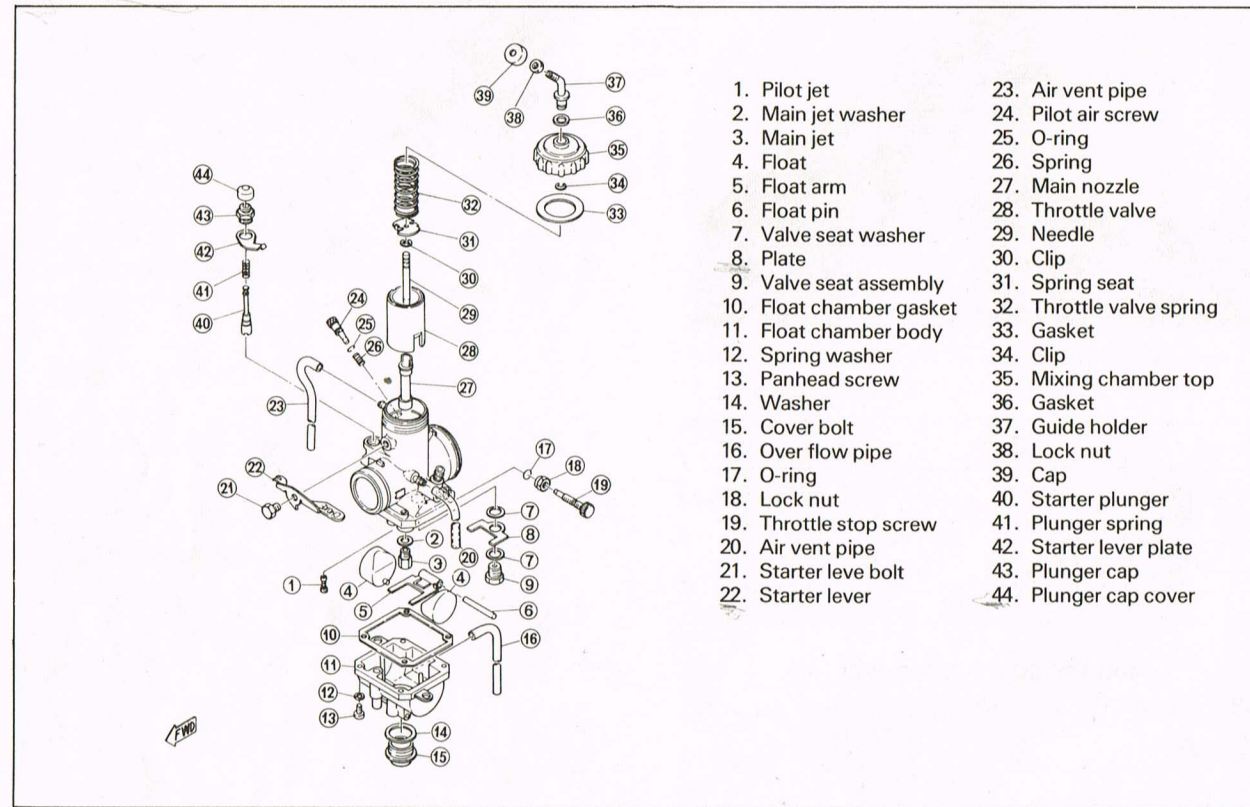

#### Replacement of main jet

1. Turn fuel petcock lever to the "OFF" position.
2. Remove the fuel line from the fitting at the carburetor.
3. Loosen the manifold and inlet joint bands (hose clamps).

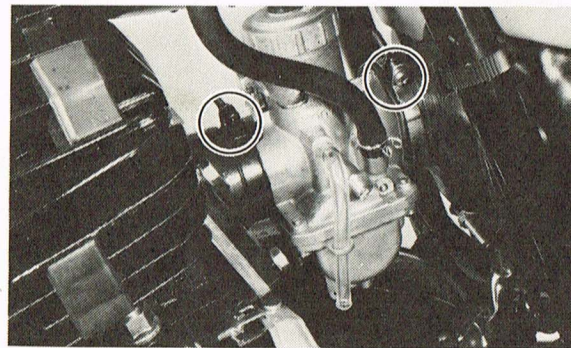

4. Remove the mixing chamber top from carburetor body.

5. Rotate carburetor, exposing main jet cover bolt.
6. Remove bolt. Main jet is located directly behind bolt.

#### WARNING:

Removing the main jet cover bolt will allow the fuel in the float bowl to drain. Do not remove if engine is hot. Place a rag under carburetor to catch overflow. Remove bolt in well-ventilated area. Do not remove near open flame. Always clean and dry machine after reassembly.

Lee Waldie Craig Scott Chris Koira

7. Remove the main jet. Change as required. Reinstall cover bolt and reassemble, reversing 1 through 3.

Standard Main Jet Size: # 200

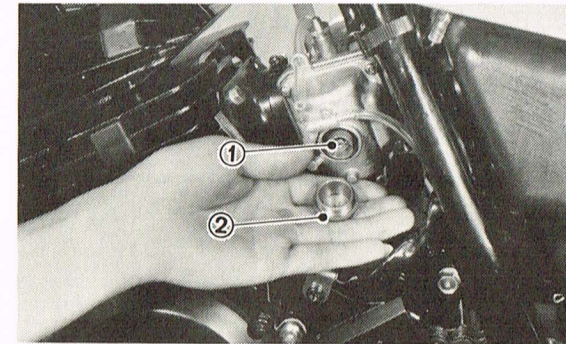

1. Main jet 2. Cover bolt

#### Inspection

1. Examine carburetor body and fuel passages. If contaminated, wash carburetor in petroleum based solvent. Do not use caustic carburetor cleaning solutions. Blow out all passages and jets with compressed air.
2. Examine condition of floats. If floats are leaking or damaged, they should be replaced.
3. Inspect float valve and seat for wear or contamination. Replace these components as a set.

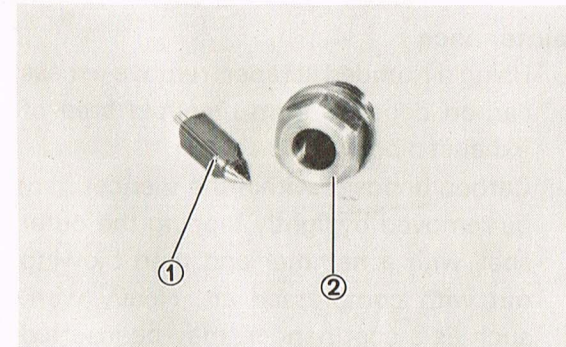

1. Float valve 2. Valve seat

#### Adjustments

1. Float level  
Measure the distance from the float arm to the float bowl surface. Bend the tang on the float arm if any float level adjustment is necessary. Both float arms must be at the same height. If the float level is too high, a lean air/fuel mixture will occur. If too low, a rich mixture will result.

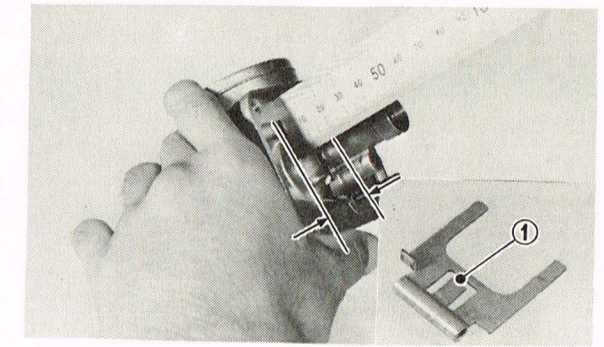

1. Tang

Float level:  $16.4 \pm 1 \text{ mm}$  ( $0.646 \pm 0.04 \text{ in}$ )

#### 2. Jet needle

The mid-range air/fuel supply is affected by the position of the needle in the needle jet. If it is necessary to alter the mid-range air/fuel mixture characteristics of the machine, the jet needle position may be changed. Move the jet needle up for a leaner condition or toward the bottom position for a richer condition.

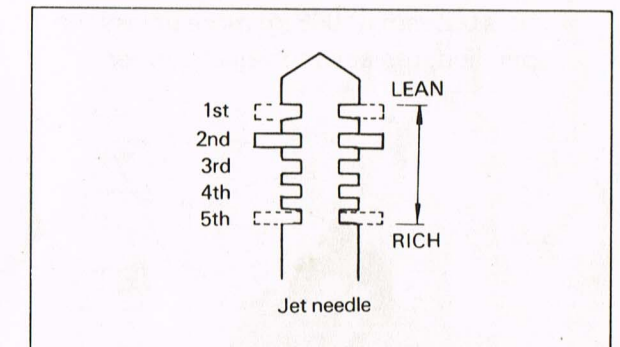

#### Reed valve Removal

1. With carburetor removed, remove the four bolts holding the intake manifold and reed valve assembly to the cylinder. Remove the reed valve assembly.



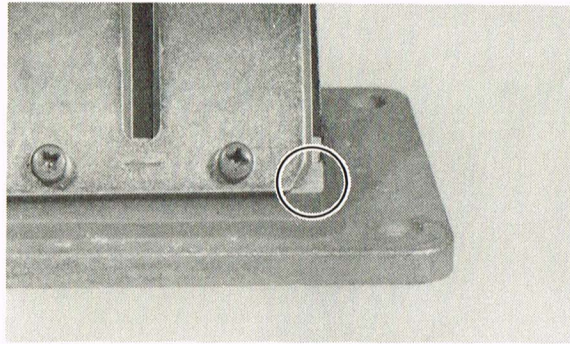

### Inspection

1. Inspect rubber intake manifold for signs of weathering, cracking or other deterioration.
2. Inspect reed petals for signs of fatigue and cracks. Reed petals should fit flush or nearly flush against neoprene seats. If in doubt as to sealing ability, apply suction to carburetor side of assembly. Leakage should be slight to moderate.
3. The valve stopper controls the movement of the valve. Check clearance "a".

Standard valve "a": 8.3 mm (0.3 in)

If it is 0.2 mm (0.008 in) more or less than specified, replace the valve stopper.

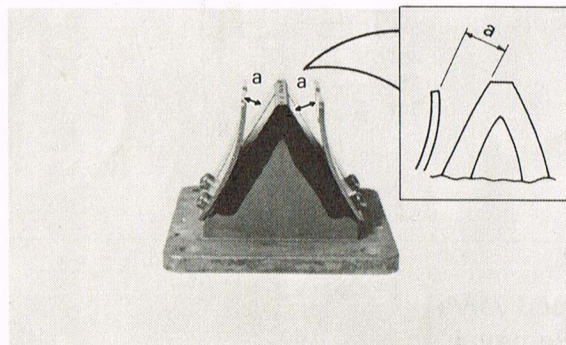

4. Check reed valve for bending. If beyond tolerance, replace reed valve.

Reed valve bending limit:  
0.3 mm (0.012 in) or less

### MUFFLER

#### Removal

1. Remove the left side cover.
2. Remove the coil springs at muffler to cylinder joint.
3. Remove the muffler mounting bolts and loosen the muffler joint screws.

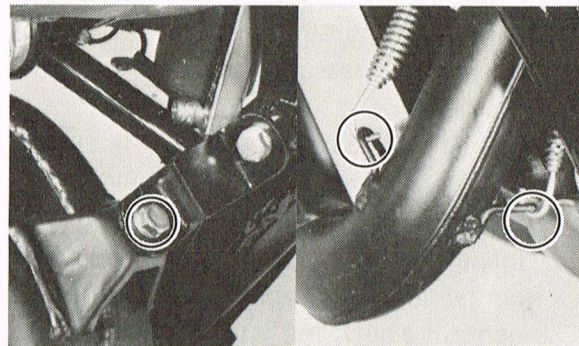
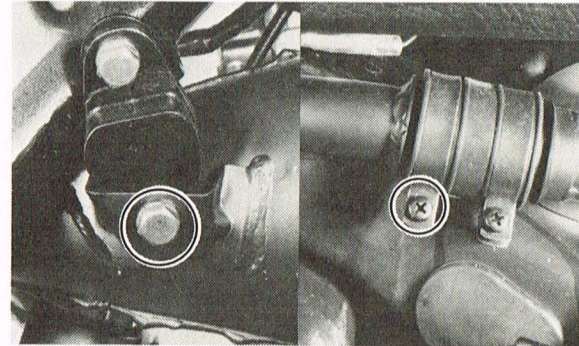

#### Maintenance

1. Using a rounded scraper, remove excess carbon deposits from manifold area of exhaust pipe.
2. Carbon deposits within the silencer may be removed by lightly tapping the outer shell with a hammer and then blowing out with compressed air. Heavy wire, such as a coat hanger, may be inserted to break loose deposits. Use care.

### TOP END

With the carburetor removed, proceed as follows:

#### Removal

1. Remove spark plug lead wire. Loosen, but do not remove spark plug.
2. Remove nuts securing cylinder and head (4 nuts).  
Remove cylinder head and gasket.

#### NOTE:

Break each nut loose (1/4 turn) prior to removing.

Martin I Henry

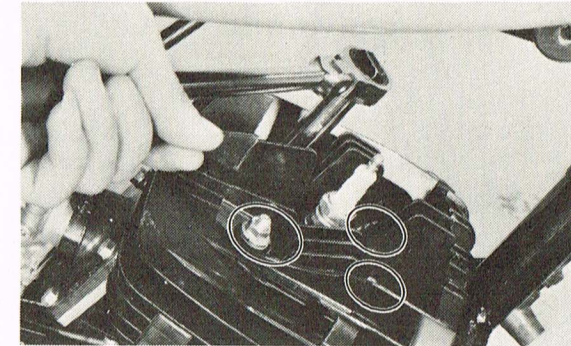

3. Remove clutch wire.

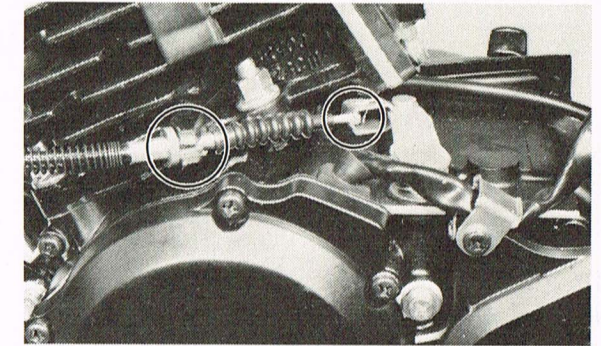

### Cylinder Head and Cylinder

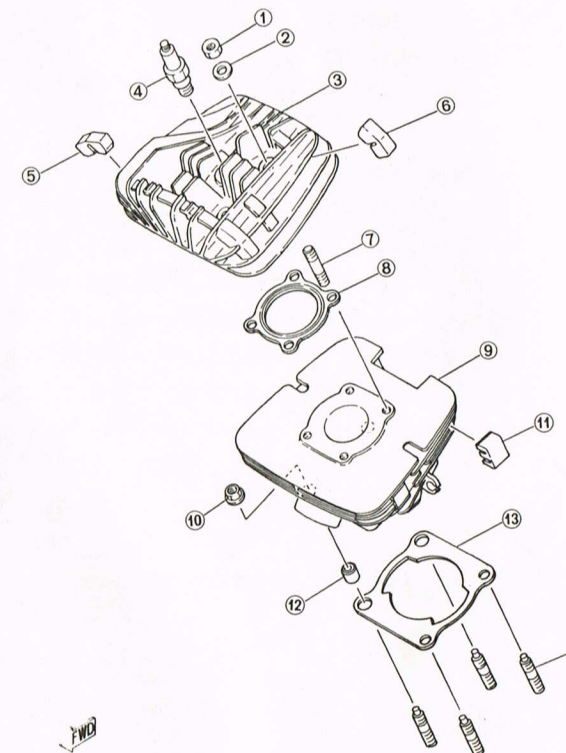

1. Hexagon nut (d = 8 mm)
2. Plate washer
3. Cylinder head
4. Spark plug (N2G, Champion)
5. Absorber 1
6. Absorber 3
7. Stud bolt
8. Cylinder head gasket
9. Cylinder
10. Nut (d = 10 mm)
11. Absorber 2
12. Dowel pin
13. Cylinder gasket
14. Stud bolt



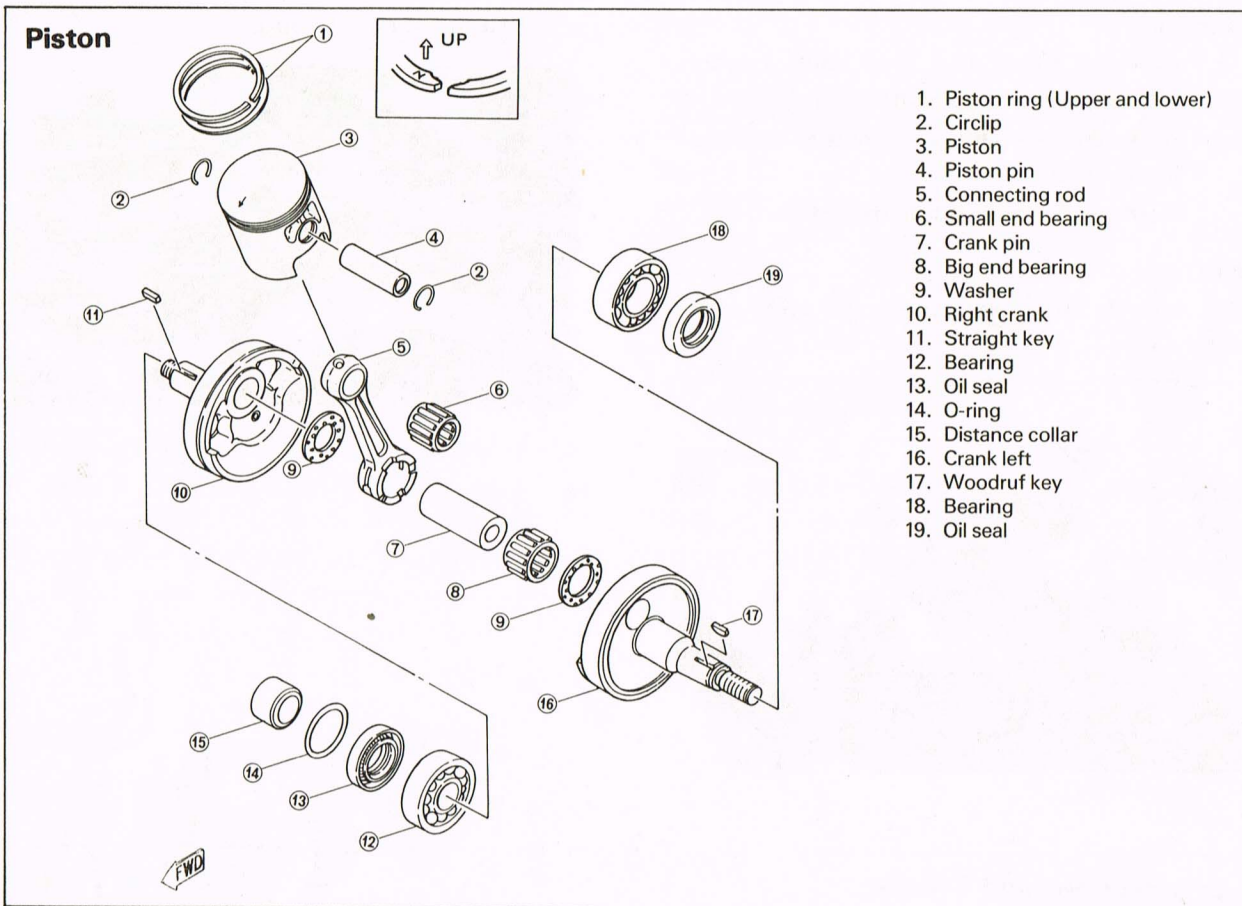

4. Remove the cylinder holding nuts.

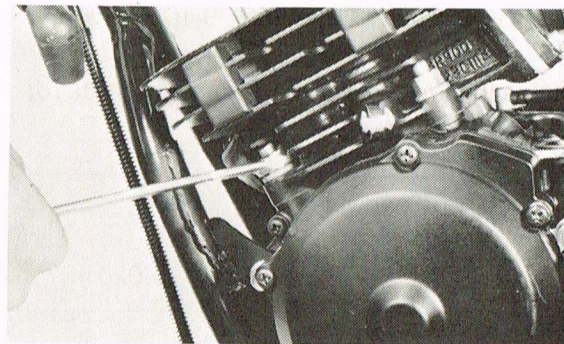

5. With the piston at top dead center, raise the cylinder until the cylinder skirts clear crankcase. Stuff a clean shop rag into crankcase cavity, around rod, to prevent dirt and other foreign particles from entering. Remove cylinder and base gasket.

6. Remove the piston and small end bearing.

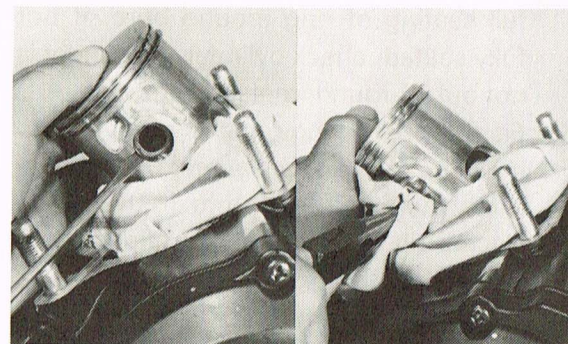

**NOTE:** If the pin hangs up, use a wrist pin puller. Do not pound on pin as damage to rod, piston and hearing will result.

**Maintenance**

**Cylinder head**

1. Remove spark plug.
2. Using a rounded scraper, remove carbon deposits from combustion chamber. Avoid scratching the metal surface.

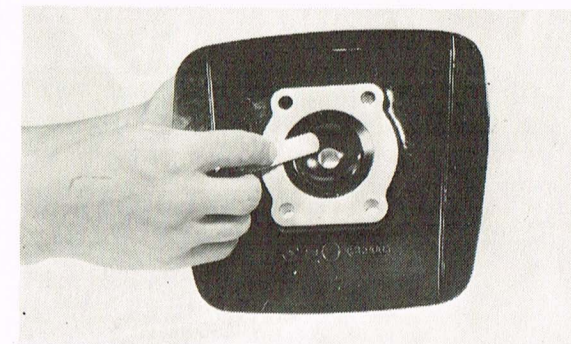

3. Place the head on a surface plate. There should be no warpage. Correct by resurfacing. Place 400-600 grit wet emery sandpaper on surface plate and resurface head using a figure-eight sanding pattern. Rotate head several times to avoid removing too much material from one side.

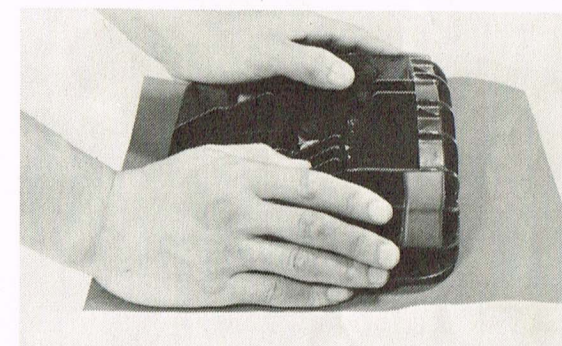

4. Clean the spark plug gasket mating surface thoroughly.
5. Wash the head in solvent and wipe dry.

**Cylinder**

1. Remove reed valve assembly.
2. Using a rounded scraper, remove carbon deposits from exhaust port.
3. Remove cylinder base gasket and clean gasket seat on cylinder and crankcase thoroughly.



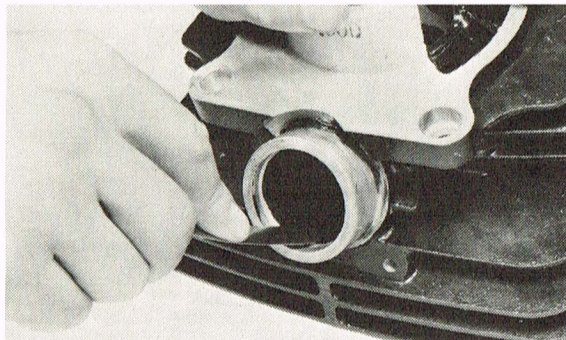

### Piston

1. Using a rounded scraper, remove carbon deposits from piston crown.
2. Break a used piston ring in two. File end square. De-burr edges to avoid scratching ring groove and clean carbon deposits from ring groove.

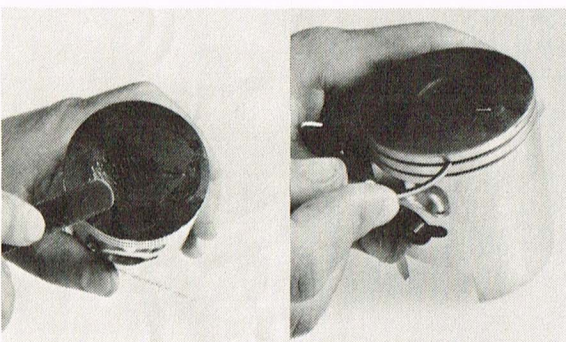

3. Using 400 — 600 grit wet sandpaper, lightly sand score marks and lacquer deposits from sides of piston. Sand in crisscross pattern. Do not sand excessively.

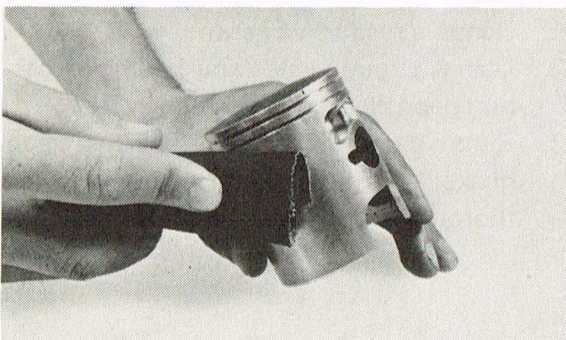

### Piston ring

1. Insert ring into cylinder. Push down approximately 20 mm (0.79 in) using piston crown to maintain right angle to bore. Measure installed end gap. If beyond tolerance, replace ring.

Ring end gap, installed:  
(Top and second)  
0.3 ~ 0.5 mm (0.012 ~ 0.020 in)

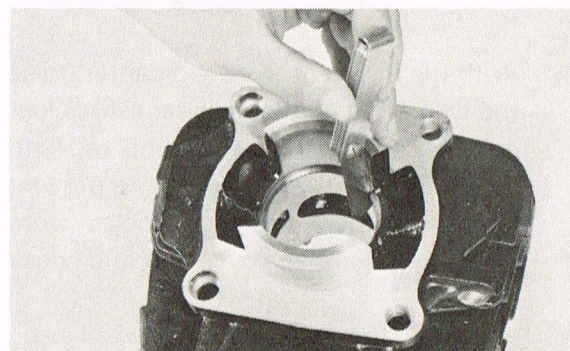

2. Holding cylinder towards light, check for full seating of ring around bore. If not fully seated, check cylinder. If cylinder is not out-of-round, replace ring.
3. Fit the piston rings in the grooves and measure the side clearance. If it measures more than 0.1 mm (0.04 in) replace both piston and piston rings as an assembly.



4. During installation, make sure ring ends are properly fitted around ring location pin in piston groove. Apply liberal coating of two-stroke oil to ring.

**NOTE:** \_\_\_\_\_  
New ring requires break-in. Follow first portion of new machine break-in procedure.

### Piston clearance

1. Cylinder bore measurement  
Using a cylinder gauge set to standard bore size, measure the cylinder. Measure front-to-rear and side-to-side at top, center and bottom just above exhaust port. Compare minimum and maximum measurements. If over tolerance and not correctable by honing, rebore to next oversize.

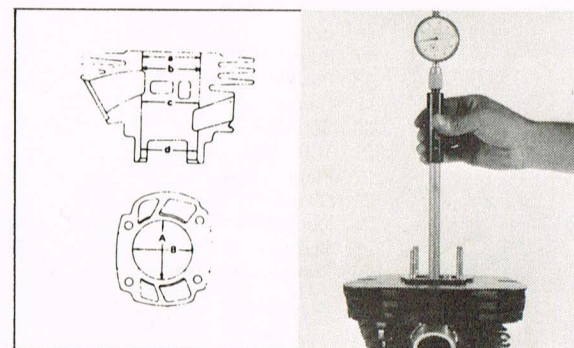

Standard bore size: 56.00 ~ 56.02 mm  
(2.205 ~ 2.206 in)

2. Piston outside diameter measurement  
Using an outside micrometer, measure piston diameter. The measuring point is at right-angles to the piston pin holes, about 10 mm (0.4 in) from the bottom of the piston skirts.

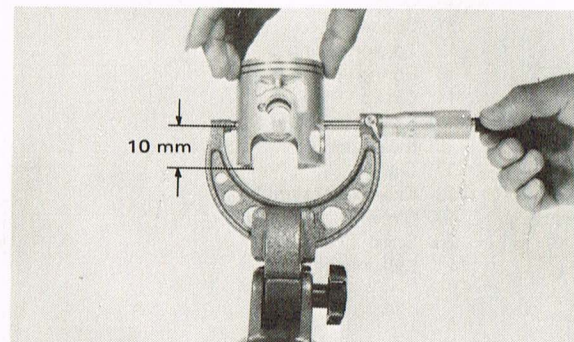

Piston clearance =  
Minimum cylinder dia. —  
Maximum piston dia.

Example:

$$56.030 \text{ mm} - 55.985 = 0.045 \text{ mm}$$

$$(2.206 - 2.204 = 0.002 \text{ in})$$

Nominal piston clearance:  
0.045 mm ~ 0.050 mm  
(0.0018 in ~ 0.002 in)

If beyond tolerance replace piston or rebore cylinder as required.

### Piston pin bearing and connecting rod

1. Check the pin for signs of wear. If any wear is evident, replace pin and bearing.
2. Check the pin and bearing for signs of heat discoloration. If excessive (heavily blued), replace both.
3. Check the bearing cage for excessive wear. Check the rollers for signs of flat spots. If found, replace pin and bearing.
4. Apply a light film of oil to pin and bearing surfaces. Install in connecting rod small end. Check for play. There should be no noticeable vertical play. If play exists, check connecting rod small end diameter for wear. Replace pin and bearing or all as required.



## Clutch

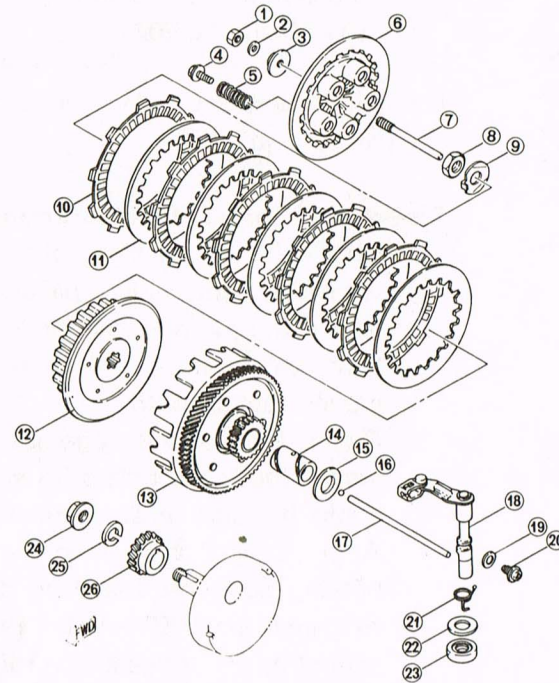

1. Hexagon nut
2. Plain washer
3. Push Plate
4. Screw with washer
5. Compression spring
6. Pressure plate
7. Push rod 1
8. Hexagon nut (d = 14 mm)
9. Lock washer
10. Friction plate
11. Clutch plate
12. Clutch boss
13. Primary drive gear complete
14. Spacer
15. Plate washer
16. Ball
17. Push rod 2
18. Push lever assembly
19. Gasket
20. Screw
21. Torsion spring
22. Plate washer
23. Oil seal
24. Nut (d = 12 mm)
25. Spring washer
26. Primary drive gear

## Kickstarter

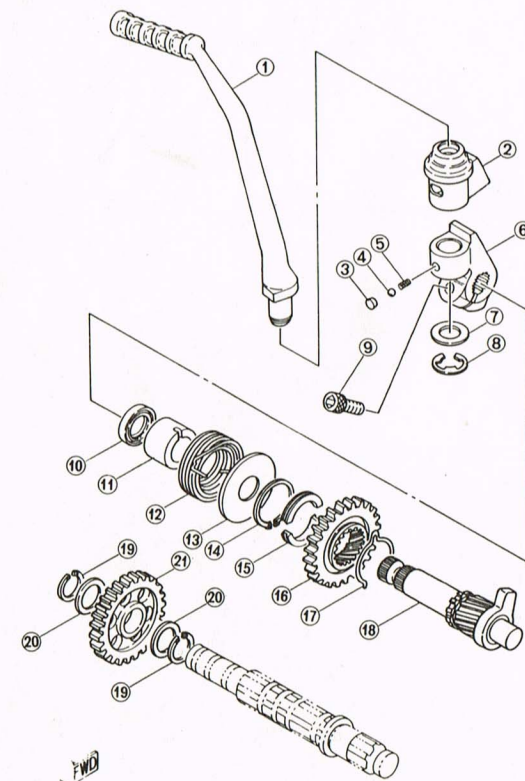

1. Kick crank
2. Kick crank boss cover
3. Plug
4. Ball (3/16 inch)
5. Compression spring
6. Kick crank boss
7. Plate washer
8. Circlip
9. Hexagon socket head bolt (d = 8 mm)
10. Oil seal
11. Spacer
12. Torsion spring
13. Spring cover
14. Circlip
15. Kick gear holder
16. Kick gear
17. Clip
18. Kick axle assembly
19. Circlip
20. Shim
21. Kick idle gear

## Clutch

### NOTE:

Clutch adjustment is covered in "Mechanical Adjustments".

### Removal

1. Remove the engine protector.

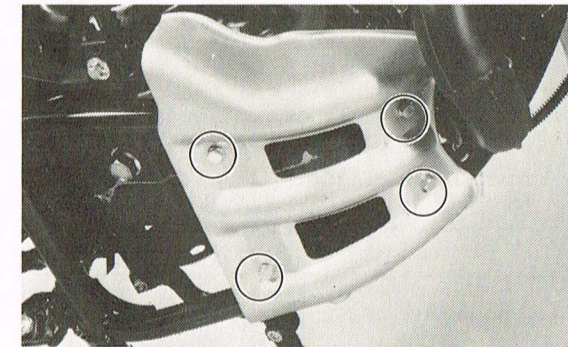

2. Remove the filler plug and drain plug, and drain the transmission oil.
3. Remove the kick starter crank.
4. Remove the pan-head screws holding the side cover in place and remove the cover. Note the position of the dowel pins.

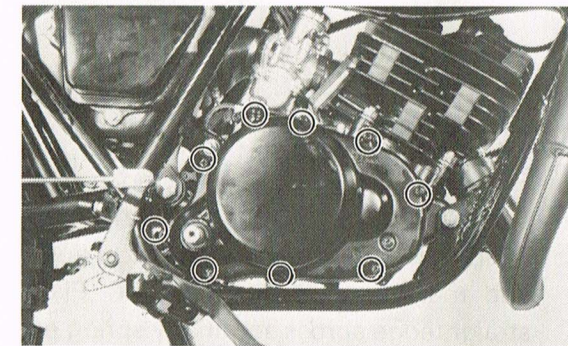

5. Remove the hexagon head screws holding the pressure plate. Remove the clutch springs, pressure plate and push rod 1. Remove the clutch plates and friction plates.

### NOTE:

When removing hexagon head screw, loosen each screw in several stages, working in a crisscross pattern, to avoid any unnecessary warpage. Note the condition of each piece as it is removed and its location within the assembly.

6. Bend lock washer tab down. Using the clutch holding tool, remove the clutch securing nut and lock washer.
7. Remove the clutch boss and driven gear (clutch housing).

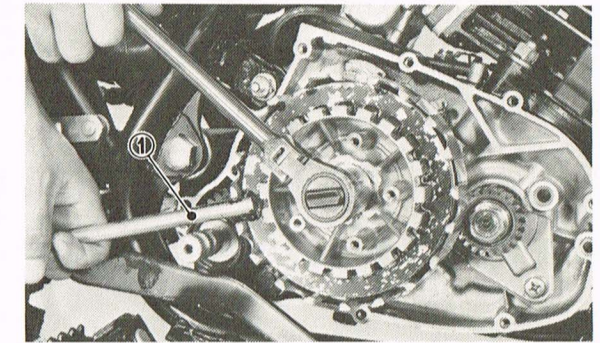

1. Clutch holding tool

8. If the clutch housing spacer remains on the transmission main shaft, remove it. Remove the thrust plate and thrust plate spacers.

### Maintenance

1. Measure the friction plates at three or four points. If their minimum thickness exceeds tolerance, replace all plates.

	New	Wear Limit
Friction plate thickness	3.0 mm (0.12 in)	2.7 mm (0.11 in)

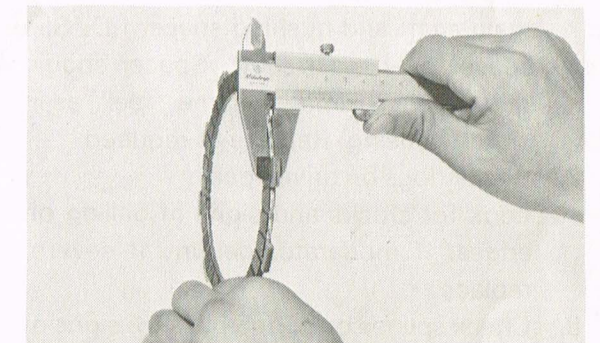

2. Check the plates for signs of warpage and heat damage, replace as required.

### NOTE:

For optimum performance, if any plate requires replacement, it is advisable to replace the entire set.



3. Check each clutch plate for signs of heat damage and warpage. Place on surface plate (plate glass is acceptable) and use feeler gauge.

Clutch plate warp allowance:  
0.05 mm (0.02 in)

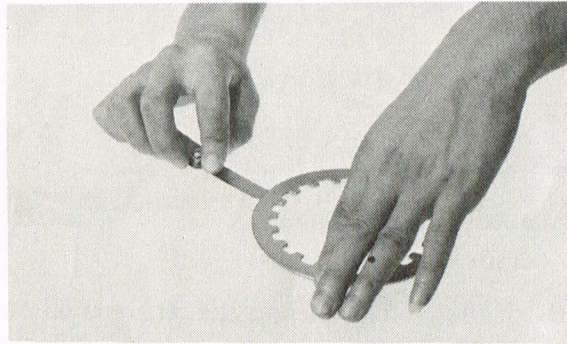

4. Thoroughly clean the clutch housing and spacer. Apply a light film of oil on the bushing surface and spacer. Fit the spacer into the bushing. It should be a smooth, thumb-press fit. The spacer should rotate smoothly within the bushing. If necessary, replace spacer or clutch housing.
5. Check the bushing and spacer for signs of galling, heat damage, etc. If severe, replace as required.
6. Apply thin coat of oil to transmission main shaft and bushing spacer I.D. Slip spacer over main shaft. Spacer should fit with approximately same "feel" as in clutch housing. Replace as required.
7. Check dogs on driven gear. Look for cracks and signs of galling on edges. If moderate, deburr. If severe, replace.
8. Check splines on clutch boss for signs of galling. If moderate, deburr. If severe, replace.

**NOTE:** Galling on either the friction plate dogs of the clutch housing or clutch plate splines of the clutch boss will cause erratic clutch operation.

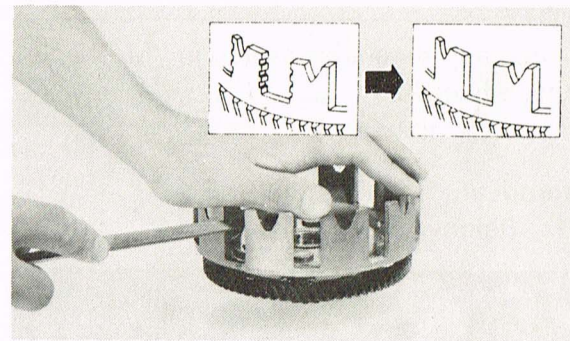

9. Measure each clutch spring. If beyond tolerance, replace.

	New	Minimum
Clutch spring free length	34 mm (1.34 in)	33 mm (1.30 in)

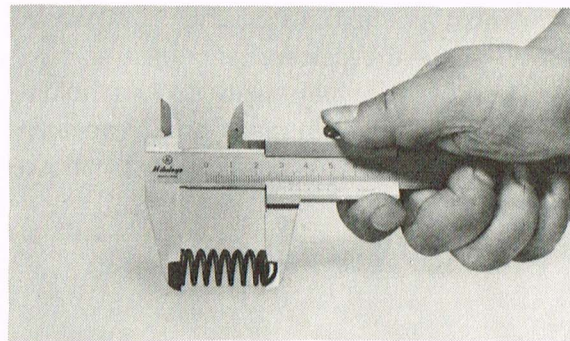

10. Stack the clutch spring set on a level surface. Rotate each spring until all are at approximately the same vertical angle and maximum apparent height. Place straightedge across set. If any spring exceeds tolerance, it is advisable to replace the clutch springs as a set.
11. Before installation, apply grease to push rod 1 and ball.

#### KICK STARTER

1. Unhook kick spring from its post in crankcase. Allow it to relax. Then remove kick axle assembly by rotating the shaft counterclockwise and then pulling out the entire assembly.

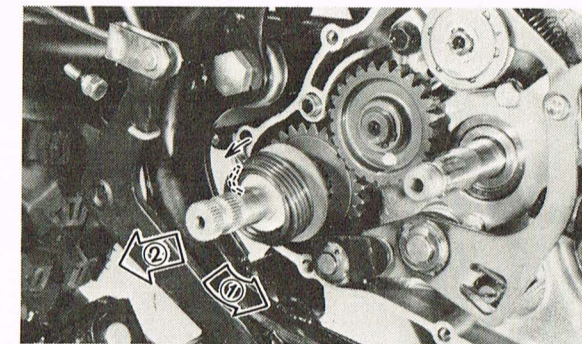

2. Check to see that the kick gear spirals freely on the worm shaft. Check the gear teeth for wear and breakage.
3. Install the kick starter assembly.
  - a. Set the kick gear clip in the groove of crankcase.
  - b. Rotate kick spring clockwise and hook it on kick spring stopper.

**NOTE:** Make sure that the kick stopper is stopped at projection of crankcase.

- c. Check whether the kick starter acts correctly and whether it returns to its home position.

Lee Waldie Craig Scott Chris Koira

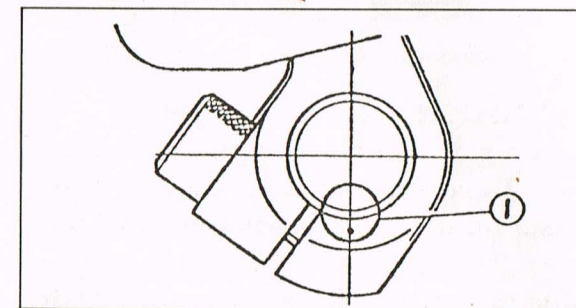

1. Matching mark

#### SHIFTER

**NOTE:** Shifter maintenance and adjustment should be performed with clutch assembly removed.

#### Removal

1. Remove the bolt and remove the change pedal.
2. Remove the circlips and washer from the change axles.
3. Pull out the change shaft assembly.

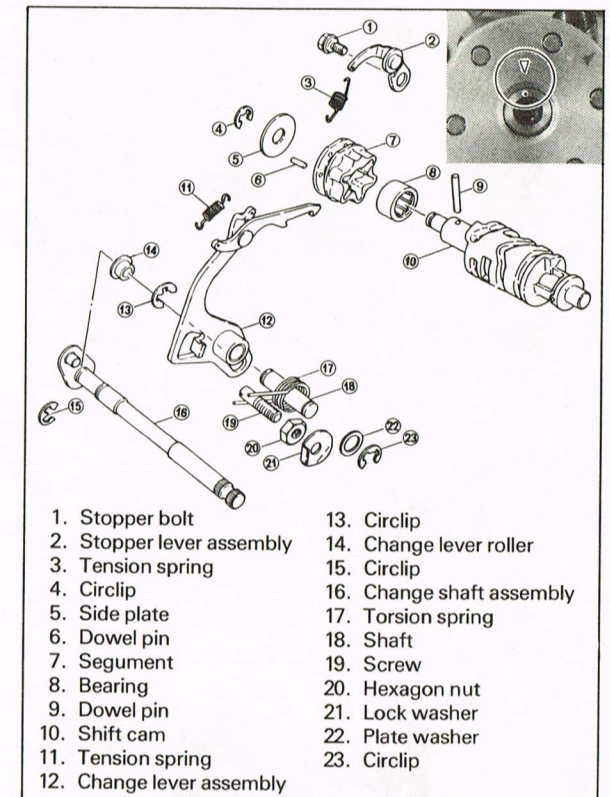

#### Inspection

1. Check the segment for signs of wear or damage. Replace as required.
2. Check shift cam dowel pins and side plate for damage, or wear. Repair as required.
3. Check stopper lever roller for wear. Replace as required.

#### Adjustment

If over-shifting (excessive turning of shift cam) or short-shifting (insufficient turning of shift cam) occurs, make adjustment of the gear shift arms by turning the stop screw (eccentric bolt) at the gear shift arm return spring. Shift into first gear. In this case, the index mark on the change lever should align perfectly with the index mark on the shift drum.

If the marks are not aligned, bend the lock washer tab down and loosen the lock nut. Turn the adjuster screw (an eccentric screw) until the marks are aligned. Tighten the lock nut.



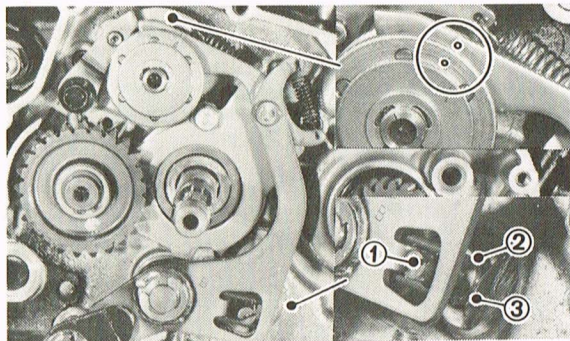

1. Adjusting screw
2. Lock nut
3. Lock washer

### Crankcase

#### Engine removal

1. Remove the magneto base, and chain cover.
2. Remove the chain and three engine mounting bolts.

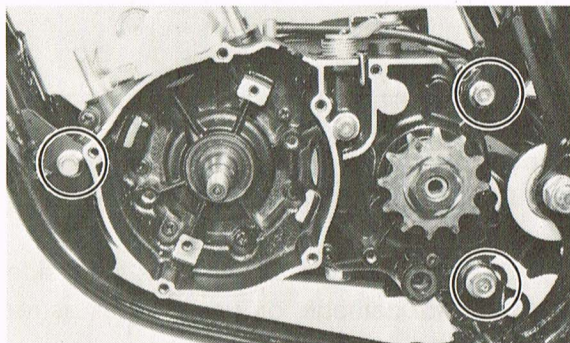

3. Remove the engine from right side of the frame.

#### Disassembling

1. Working in a crisscross pattern, loosen 12 panhead screws 1/4 turn each, and remove the screws.

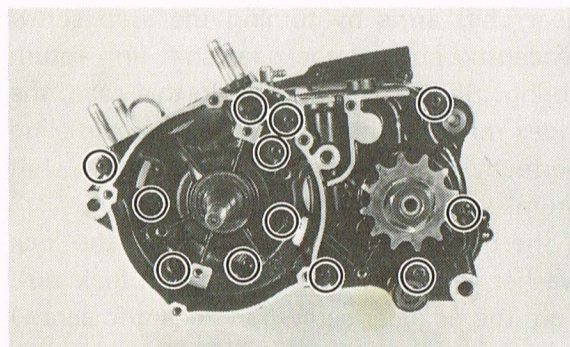

2. Remove the oil seal retainer and bearing cover plate. Install crankcase separating tool as shown.

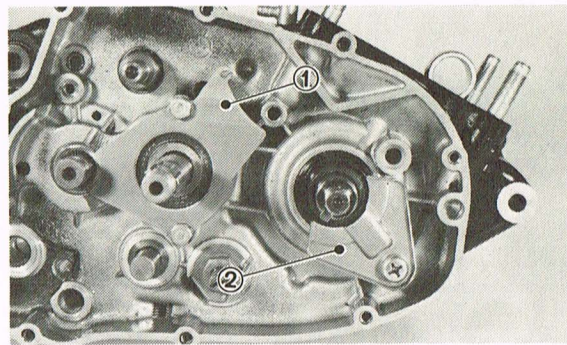

1. Bearing cover plate
2. Oil seal holder

#### NOTE:

Tighten the securing bolts on the crankcase separating tool, but make sure the tool body is parallel with the case. If necessary, one screw may be backed out slightly to level tool body.

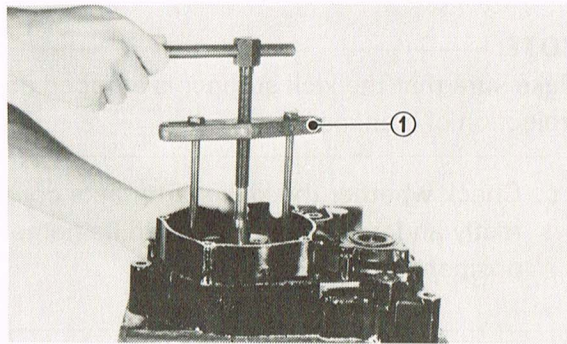

1. Crankcase separating tool

#### CAUTION:

Use a soft hammer to tap on the case half. Tap only on reinforced portions of case. Do not tap on gasket mating surface. Work slowly and carefully. Make sure the case halves separate evenly. If one end "hangs up", take pressure off the push screw, realign and start over. If the halves are reluctant to separate, check for a remaining case screw or fitting. Do not force.

#### Bearings and Oil Seals

1. After cleaning and lubricating the bearings, rotate inner race with a finger. If rough spots are noticed, replace the bearing.

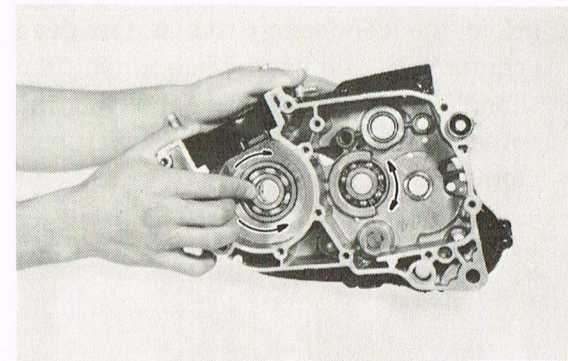

#### NOTE:

Bearing(s) are most easily removed or installed if the cases are first heated to approximately 90° ~ 120°C (194° ~ 248°F). Bring the case up to proper temperature slowly. Use an oven.

2. Check oil seal lips for damage or wear. Replace as required.

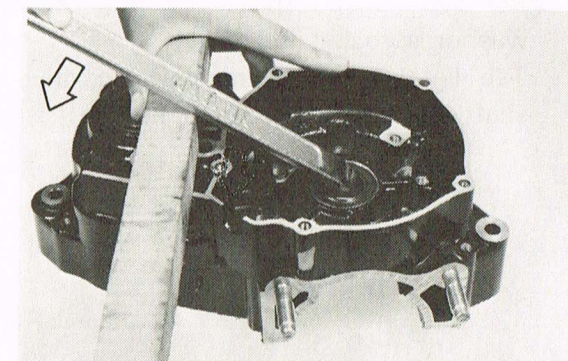

3. Always replace crankshaft oil seals whenever the crankshaft is removed.
4. Install bearing(s) and oil seal(s) with their manufacturer marks or numbers facing outward. Before installation, apply grease to oil seal lip(s) and bearing(s).

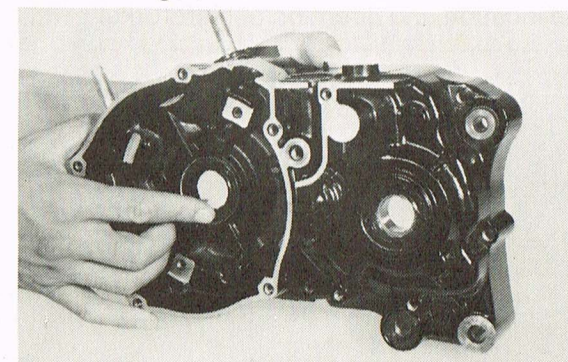

#### Crankshaft

1. Remove crankshaft assembly with crankcase separating tool.

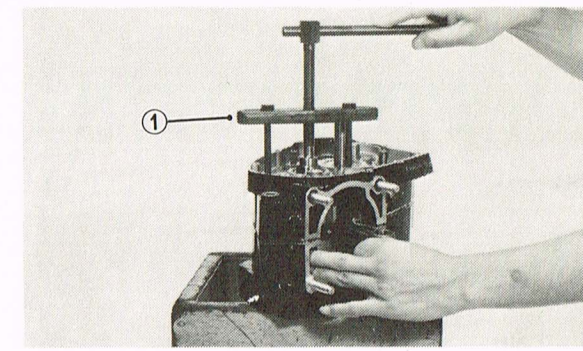

1. Crankcase separating tool

#### Inspection

1. The crankshaft requires the highest degree of accuracy in engineering and servicing of all the engine parts.
2. The crankshaft is susceptible to wear and therefore the crank bearing must be inspected with special care.
3. Check crankshaft components.
  - a. Mount the dial gauge at right angles to the connecting rod small end, holding the bottom of rod toward the dial indicator. Rock top of rod and measure axial play.

Connecting rod axial play (C):  
0.4 ~ 2.0 mm (0.016 ~ 0.079 in)

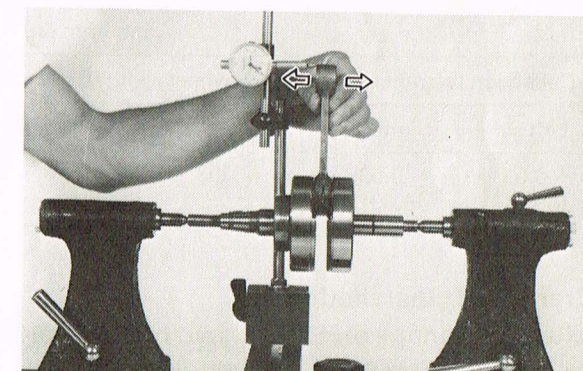

- b. Remove the dial gauge and slide the connecting rod to one side. Insert a thickness gauge between the side of the connecting rod big end and the crank wheel. Measure clearance.



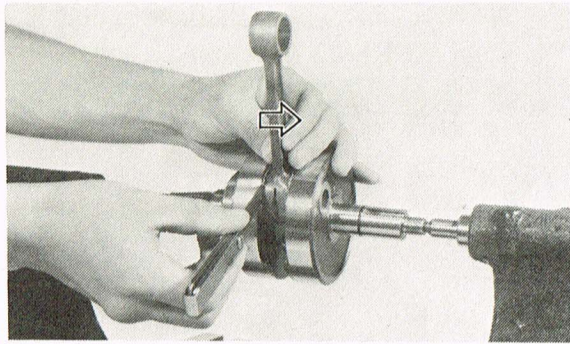

Connecting rod/crank side clearance (D):  
0.20 ~ 0.70 mm (0.008 ~ 0.028 in)

- c. If any of the above measurements exceed tolerance, crankshaft repair is required. Take the machine to your Authorized Yamaha Dealer.

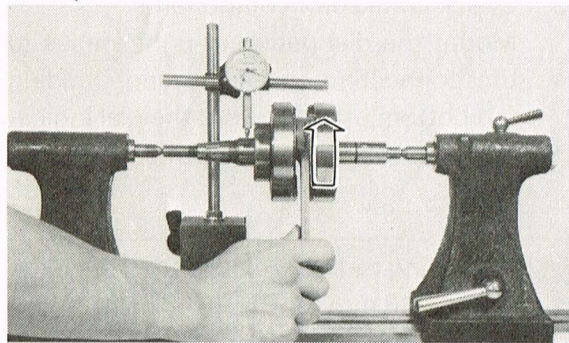

Unit: mm (in)

Deflection tolerance (A)		Flywheel width (B)
Left side	Right side	
0.03 (0.0012)	0.03 (0.0012)	55.95 ~ 55.90 mm (2.203 ~ 2.2008 in)

### Crankshaft Installation

After all bearings and seals have been installed in both crankcase halves, install crankshaft as follows:

#### CAUTION:

To protect the crankshaft against scratches or to facilitate the operation of installation: Pack the oil seal lips with grease. Apply engine oil to each bearing.

1. Set the crankshaft into left case half and install crankshaft installing tool.

2. Hold the connecting rod at top dead center with one hand while turning the handle of the installing tool with the other. Operate tool until crankshaft bottoms against bearing.

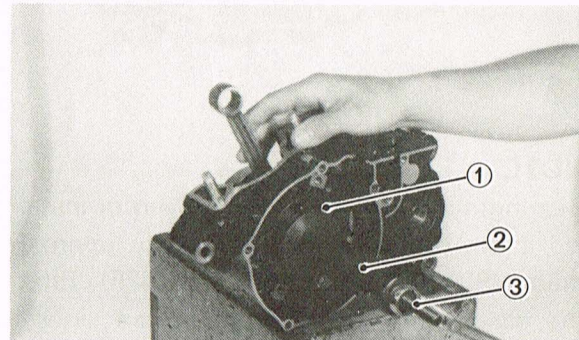

1. Adapter
2. Crankshaft installer pot
3. Crankshaft installer bolt

### Transmission and shifter

1. Remove drive sprocket nut, lock washer, sprocket and collar.
2. Tap lightly on the transmission drive shaft with a soft hammer to remove.

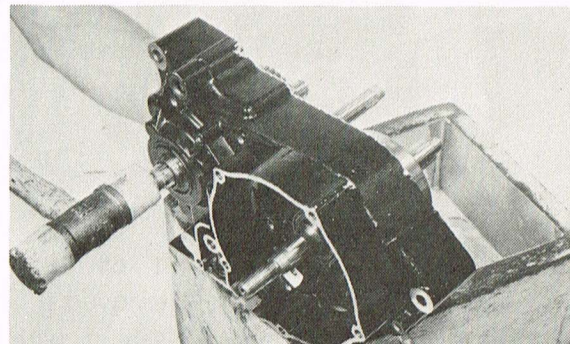

#### NOTE:

Remove assembly carefully. Note the position of each part. Pay particular attention to the location and direction of shift forks.

### Inspection

1. Inspect each shift fork for signs of galling on gear contact surfaces. Check for bending. Make sure each fork slides freely on its guide bar.
2. Roll the guide bars across a surface plate. If any bar is bent, replace.

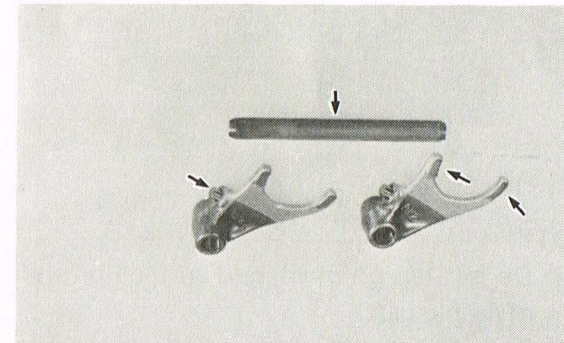

3. Check the shift cam grooves for signs of wear or damage. If any profile has excessive wear and/or any damage, replace cam.
4. Check the cam followers on each shift fork for wear. The follower should fit snugly into its seat in the shift fork, but should not be overly tight. Check the ends that ride in the grooves in the shift cam. If they are worn or damaged, replace.
5. Check shift cam dowel pins and side plate for looseness, damage, or wear. Repair as required, or replace.
6. Check the shift cam stopper plate, circlip, stopper for wear.

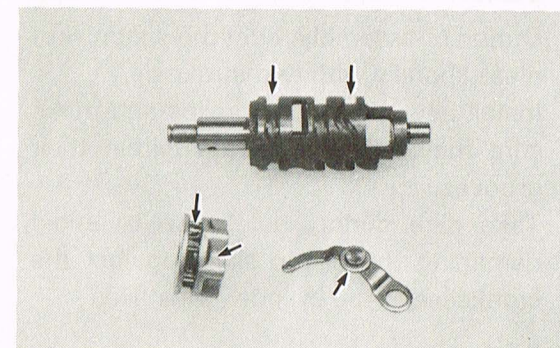

7. Check the transmission shafts using a centering device and dial gauge. If any shaft is bent, replace.

8. Carefully inspect each gear. Look for signs of obvious heat damage (blue discoloration). Check the gear teeth for signs of pitting, galling, or other extreme wear. Replace as required.
9. Check to see that all each gear moves freely on its shaft.

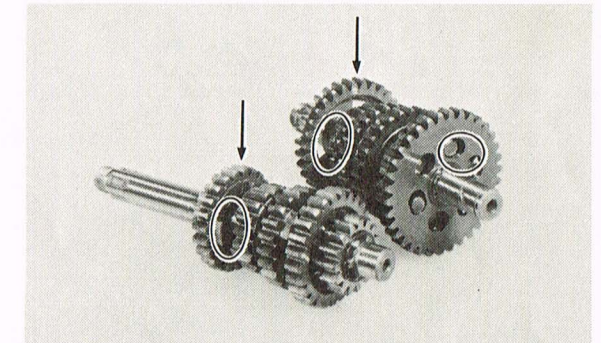

10. Check to see that all washers and clips are properly installed and undamaged. Replace bent or loose clips and bent washers.
11. Check to see that each gear properly engages its counterpart on the shaft. Check the mating dogs for rounded edges, cracks, or missing portions. Replace as required.

### Installation

1. Check to see that all parts move freely and that all loose shims are in place. Make sure all shafts are fully seated.

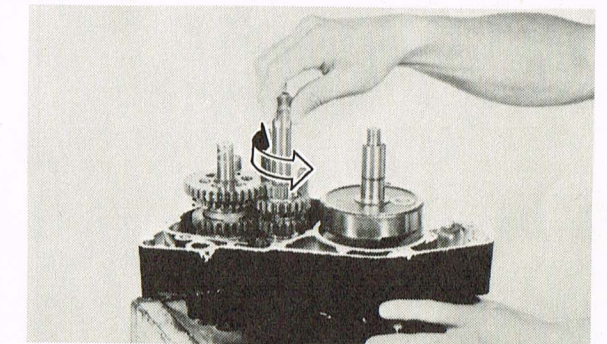



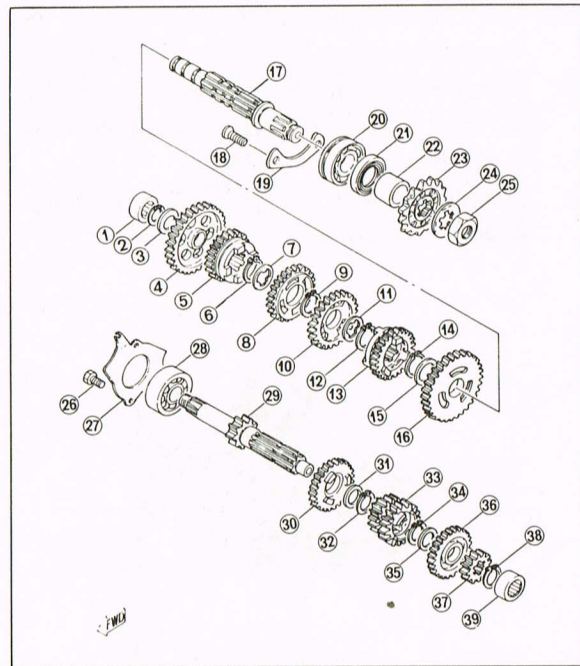

- |                    |                         |                         |
|--------------------|-------------------------|-------------------------|
| 1. Bearing         | 16. 2nd wheel gear      | 31. Plate washer        |
| 2. Circlip         | 17. Drive axle          | 32. Circlip             |
| 3. Thrust washer   | 18. Flat head screw     | 33. 3rd/4th pinion gear |
| 4. 1st wheel gear  | 19. Bearing cover plate | 34. Circlip             |
| 5. 5th wheel gear  | 20. Bearing             | 35. Plate washer        |
| 6. Circlip         | 21. Oil seal            | 36. 6th pinion gear     |
| 7. Washer          | 22. Collar              | 37. 2nd pinion gear     |
| 8. 3rd wheel gear  | 23. Drive sprocket      | 38. Circlip             |
| 9. Circlip         | 24. Lock washer         | 39. Bearing             |
| 10. 4th wheel gear | 25. Nut (d = 16 mm)     |                         |
| 11. Washer         | 26. Hexagon bolt        |                         |
| 12. Circlip        | 27. Bearing cover plate |                         |
| 13. 6th wheel gear | 28. Bearing             |                         |
| 14. Circlip        | 29. Main axle           |                         |
| 15. Plate washer   | 30. 5th pinion gear     |                         |

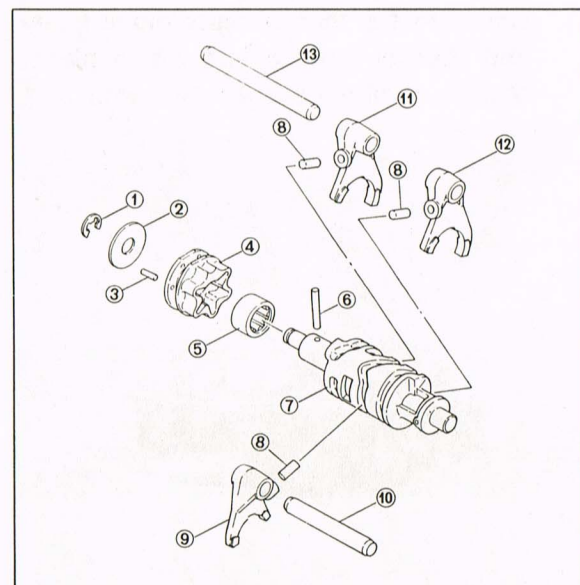

- |               |                            |
|---------------|----------------------------|
| 1. Circlip    | 8. Straight pin            |
| 2. Side plate | 9. Shift fork 2            |
| 3. Dowel pin  | 10. Shift fork guide bar 1 |
| 4. Segment    | 11. Shift fork 3           |
| 5. Bearing    | 12. Shift fork 1           |
| 6. Dowel pin  | 13. Shift fork guide bar 2 |
| 7. Shift cam  |                            |

### Reassembling

1. Apply YAMAHA BOND #4 to the mating surfaces of both case halves.

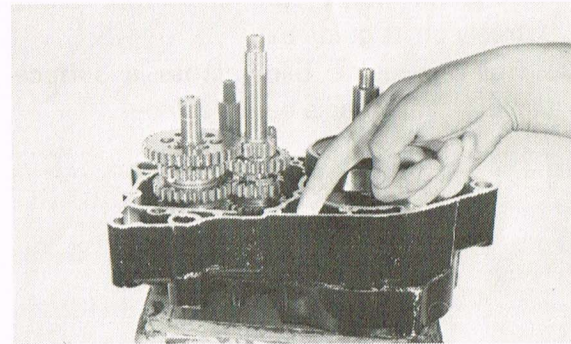

### NOTE:

- a. Do not tap on machined surface or end of crankshaft.
- b. Before installing the crankshaft, check the crankshaft O-ring for damage.

2. After reassembly, apply a liberal coating of two-stroke oil to the crank pin and bearing and into each crankshaft bearing oil delivery hole.
3. Check crankshaft and transmission shafts for proper operation and freedom of movement.
4. During re-assembly, always use a new cylinder base gasket.

Cylinder nut torque:  
3.5 m-kp (25 ft-lb)

Cylinder head nut torque:  
2.5 m-kp (18 ft-lb)

5. During re-assembly, coat the piston skirt areas liberally with two-stroke oil.
6. Install new piston pin circlips and make sure they are fully seated within their grooves.
7. Take care during installation to avoid damaging the piston skirts against the crankcase as the cylinder is installed.

### NOTE:

The arrow on piston dome must face forward.

### Mounting

1. Install engine mounting bolts and nuts with proper tightening torque.

Tightening torque:

Front	2.5 m-kp (18 ft-lb)
Rear, upper	2.5 m-kp (18 ft-lb)
Rear, lower	4.0 m-kp (28 ft-lb)

2. Install drive sprocket.

Drive sprocket nut torque:  
5.5 m-kp (40 ft-lb)

3. Install flywheel magneto.

Rotor nut torque:  
7.0 m-kp (50 ft-lb)

## CHASSIS

### Front wheel removal

1. Elevate the front wheel by placing a suitable stand under the engine.
2. Remove brake cable. Loosen all cable adjusters and remove cable from handle lever holder. Then remove cable from cam lever at front brake shoe plate.
3. Remove speedometer cable from front brake shoe plate: First remove clip and then pull cable out.
4. Remove cotter pin from front wheel axle and remove axle nut.

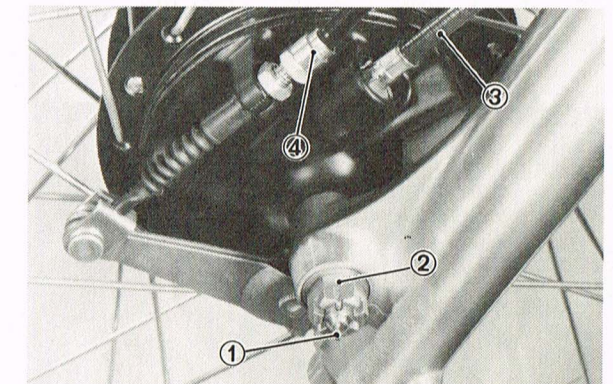

- |               |                      |
|---------------|----------------------|
| 1. Cotter pin | 3. Speedometer cable |
| 2. Axle nut   | 4. Brake cable       |

5. Turn and pull out the front wheel axle; the wheel assembly can now be removed.

### Front wheel installation

When installing front wheel, reverse the removal procedure taking care of the following points:

1. Check for proper engagement of the boss on the outer fork tube with the locating slot on the brake shoe plate.

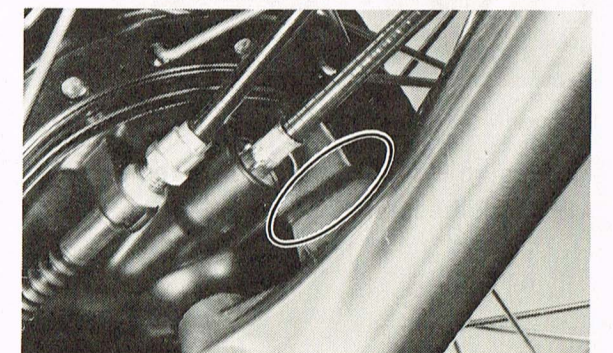



2. Always secure the front wheel axle as follows:
  - a. Torque the front axle nut.

Axle nut torque: 4.0 m·kg (28 ft·lb)

- b. Install a new cotter pin; discard old pin.
- c. Adjust the play in the brake lever.

#### Rear wheel removal

1. Elevate the rear wheel by placing a suitable stand under the engine.
2. Remove the brake adjuster and brake rod from the brake arm.
3. Remove the cotter pin from the axle nut and loosen the axle nut.

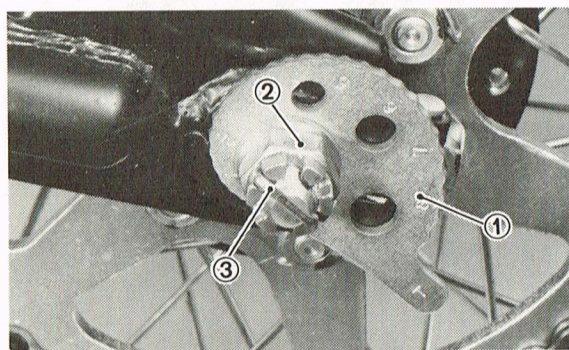

1. Chain puller 2. Axle nut 3. Cotter pin

4. Remove the link clip and joint link and remove the chain.
5. Remove the cotter pins (left and right). Then remove the clevis pins.

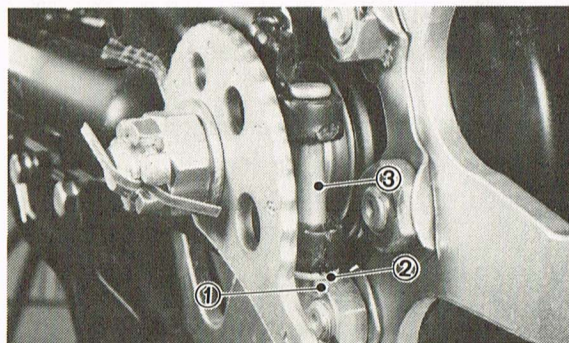

1. Cotter pin 2. Plain washer 3. Clevis pin

6. Pull the wheel backward, remove the rear wheel assembly.

#### Rear wheel installation

The rear wheel can be reassembled by reversing the disassembly procedure. Take care of the following points.

1. When connecting the chain, make certain closed end of joint link clip is facing direction of rotation.

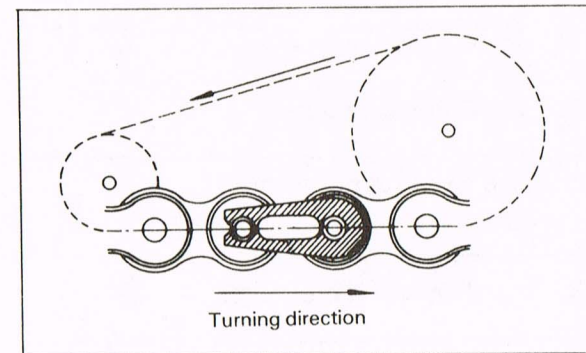

2. Check for proper engagement of the boss on swing arm with the locating slot on brake shoe plate.

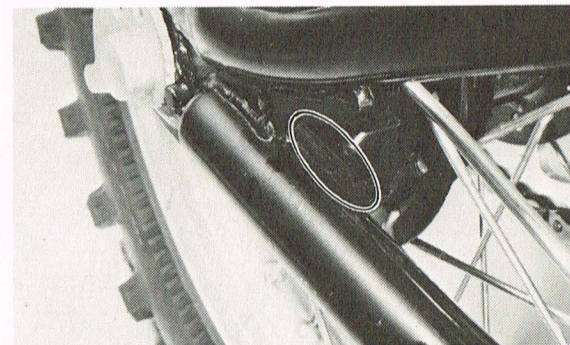

3. Make sure the rear axle nut is properly torqued.

Tightening torque: 8.5 m·kg (60 ft·lb)

4. Make sure you adjust the chain tension. (See page 16).
5. Adjust brake pedal free play.
6. Always use NEW cotter pins.

#### Brake shoe

Measure the outside diameter at the brake shoe with slide calipers. If it measures less than specified limit replace brake shoes.

Minimum brake lining thickness: 2 mm

	Brake shoe dia.	Wear limit
Front	110 mm (4.33 in)	106 mm (4.17 in)
Rear	130 mm (5.12 in)	126 mm (4.96 in)

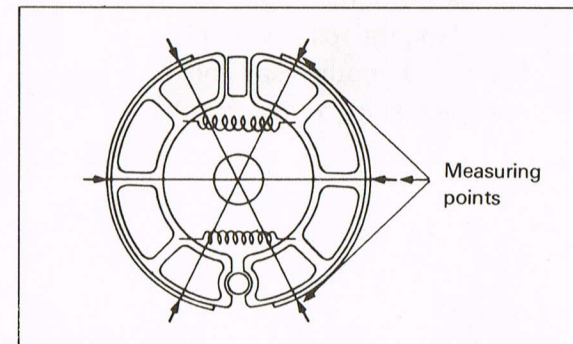

#### Brake drum

Oil or scratches on the inner surface of the brake drum will impair braking performance or result in abnormal noises. Remove oil by wiping with a rag soaked in lacquer thinner or solvent. Remove scratches by lightly and evenly rubbing with emery cloth.

#### Tire removal and tire repair

1. Remove the wheel from the motorcycle.
2. Remove lock nut from valve stem and release as much air as possible from the tire.
3. Push both tire beads away from the edges of the rim.
4. Starting opposite the valve stem on one side, use two round-ended tire irons to work the bead off the rim.

#### NOTE:

Use a tire removal lubricant and be careful not to pinch the tube with the tire irons.

5. Remove the valve stem from its hole and remove the tube.
6. If the tire is to be changed, remove the second bead from the rim using the tire irons and tire lubricant.

#### Inspection

1. Use a cloth to check for nails or other sharp objects in the tire.

#### CAUTION:

Always use a cloth to avoid cutting your hand.

2. Check for faults in the side wall. If there is any fault, the tire should be replaced as a damaged tire may burst at high speeds, which is extremely dangerous.
3. Inflate the tube with air and check the valve stem and the tube for damage and leakage replace as required. Some leaks can be patched in an emergency, but it is best to replace tube.

#### Reassembly

1. Install one tire bead on the rim using tire irons and lubricant and then install the tube.
2. Inflate tube with air to about one-third the specified pressure. Hit the outer circumference of the tire with a soft hammer to make certain the tube is not caught between tire and rim. Release air from tube.
3. Inspect rim band and replace if damaged.
4. Install second tire bead starting opposite the valve stem using tire irons and tire mounting lubricant.
5. Inflate tire to approximately 3 kg/cm<sup>2</sup> (42 psi) and then reduce pressure to specified setting.

#### NOTE:

Check the valve stem; it must be pointing directly at center of wheel hub. If angled in any direction, release air and adjust tube position.



### Replacing wheel bearings

If the bearings allow excessive play in the wheel or if it does not turn smoothly have your dealer replace the wheel bearings.

### Checking rim

1. Check for cracks, bends or warpage of rim. If a rim is deformed or cracked, it must be replaced.
2. Check wheel run-out  
If deflection exceeds tolerance, check wheel bearing or replace wheel as required.

Rim run-out limits:  
Vertical — 2.0 mm (0.08 in)  
Lateral — 2.0 mm (0.08 in)

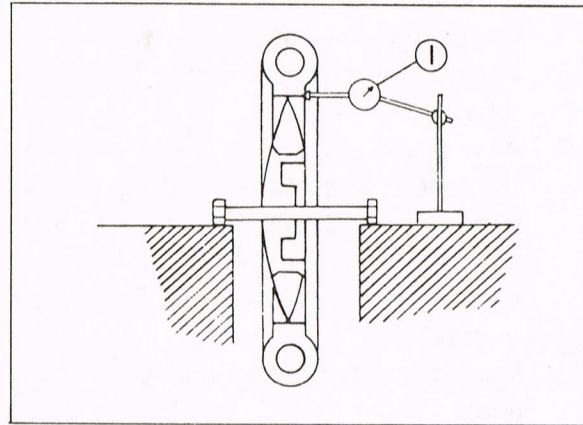

### Sprockets

#### NOTE:

Please refer to Maintenance Intervals and Lubrication Intervals charts for additional information.

1. Check sprocket wear. Replace if wear decrease tooth height to a point approaching the roller center line.
2. Replace if tooth wear shows a pattern such as that in the illustration.

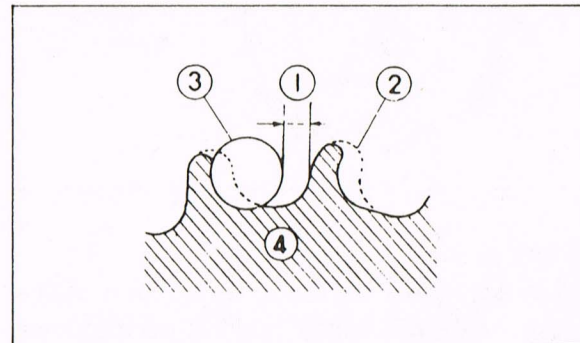

1. 1/4 tooth 2. Correct 3. Roller 4. Sprocket

Drive sprocket securing nut torque:  
5.5 m-kg (40 ft-lb)

Driven sprocket securing nut torque:  
4.0 m-kg (28 ft-lb)

3. When replacing the sprocket, always use a new lock washer. After tightening the sprocket nut to the specification, be sure to lock it with the lock washer.

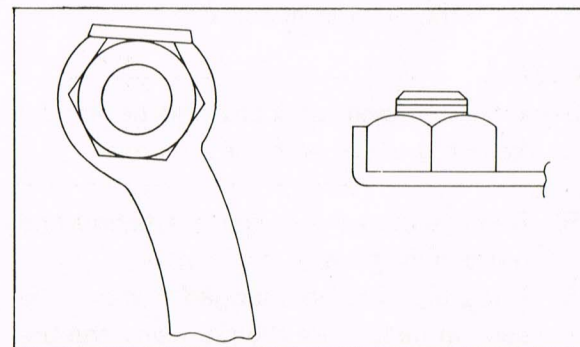

### Chain Maintenance

1. With the chain installed on the machine, excessive wear may be roughly determined by attempting to pull the chain away from the rear sprocket. If the chain will lift away more than one-half the length of the sprocket teeth, remove and inspect. If any portion of the chain shows signs of damage, or if either sprocket shows signs of excessive wear, remove and inspect.

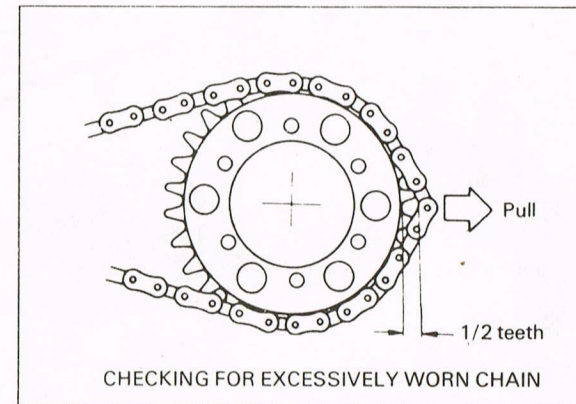

CHECKING FOR EXCESSIVELY WORN CHAIN

2. The chain should be lubricated after every use of the machine.
3. Wipe off dirt with shop rag. If accumulation is severe, use wire brush, then rag.
4. Apply lubricant between roller and side plates on both inside and outside of chain. Don't skip a portion as this will cause uneven wear. Apply thoroughly. Wipe off excess.

#### NOTE: Lee Waldie Craig Scott Chris Koira

Chain and lubricant should be at room temperature to assure penetration of lubricant into rollers.

Use Yamaha Chain and Cable Spray Lubricant.

5. Periodically, remove the chain, wipe and/or brush excess dirt off. Blow off with high pressure air.
6. Soak chain in solvent, brushing off remaining dirt. Dry with high pressure air. Lubricate thoroughly while off machine. Work each roller thoroughly to make sure lubricant penetrates. Wipe off excess. Re-install.

### Front Forks

#### Front fork oil change

1. Elevate front wheel by placing a suitable stand under the engine.
2. Loosen the handle crown pinch bolts.
3. Remove cap bolts from inner fork tubes and remove the washer and spring.
4. Place container under each fork tube. Remove drain screw from each outer tube.

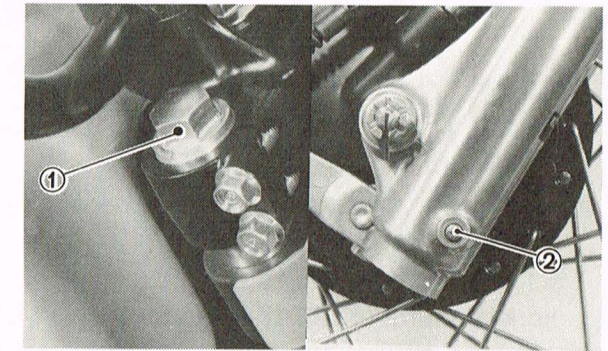

1. Cap bolt

2. Drain screw

5. After most of oil has drained, slowly raise and lower outer tubes to pump out remaining oil.
6. Install drain screws.

#### NOTE:

Check gasket, replace if damaged.

7. Measure correct amount of oil and pour into each leg.

Recommended oil:  
Yamaha Fork Oil 10Wt or  
SAE # 10 motor oil

Quantity per leg: 258 cc (8.7 oz)

#### NOTE:

Select the weight oil that suits local conditions and your preference (lighter for less damping, heavier for more damping).



8. After filling, slowly pump the outer tubes up and down to distribute the oil.
9. Inspect O-ring on fork cap bolts and replace if damaged.

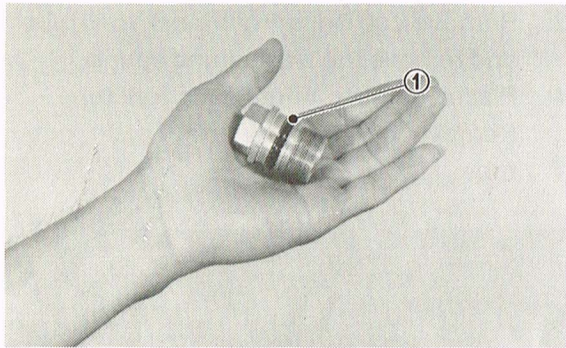

1. O-ring

10. Install cap bolt, spring and spacer and torque to specification.

Fork cap torque: 2.3 m-kg (16 ft-lb)

11. Tighten the handle crown pinch bolts to specification.

Tightening torque: 3.5 m-kg (25 ft-lb)

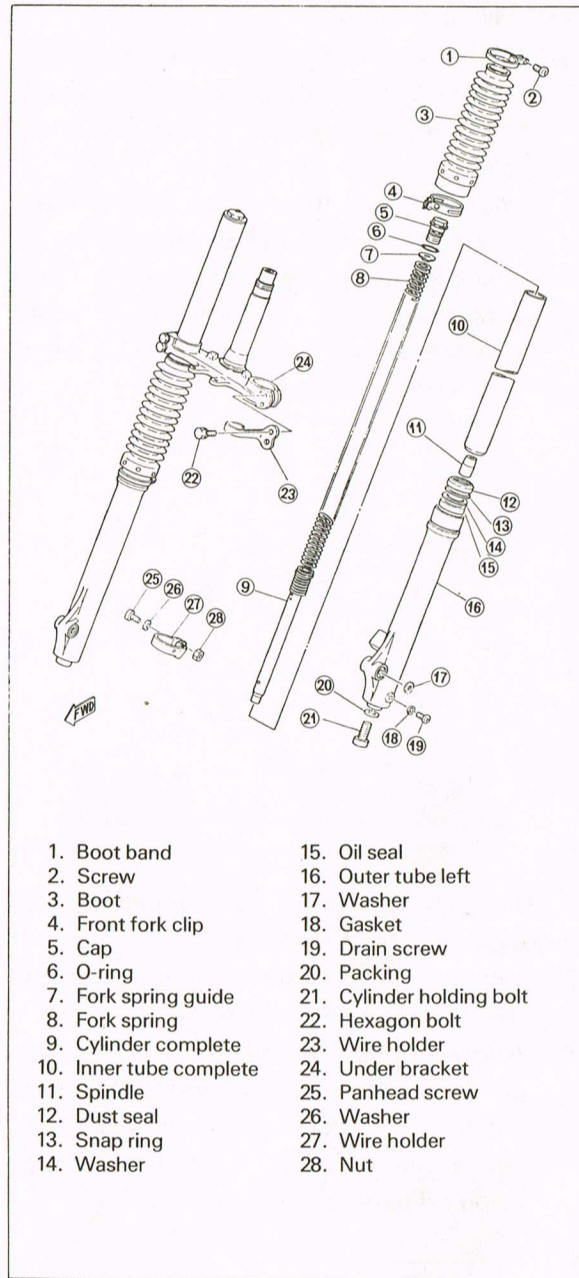

#### Front fork oil seal change

1. To disassemble the front fork assembly, remove the cylinder holding bolt from the bottom of the outer tube and pull the inner and outer tubes apart.

#### NOTE:

Use the cylinder holding wrench for removing the cylinder holding bolt.

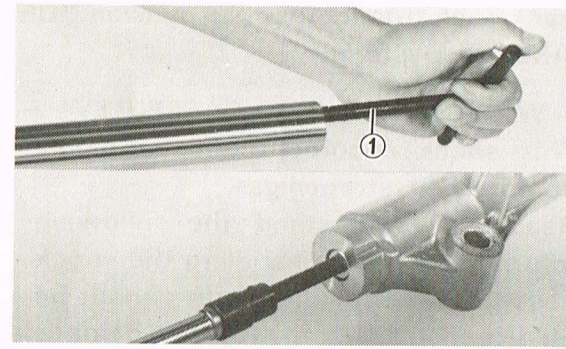

1. Fork spring guide wrench

2. Pry out the dust seal, and remove the snap ring and washer.  
Pry out the damaged oil seal.

#### CAUTION:

Take care during removal to avoid damaging the outer tube.

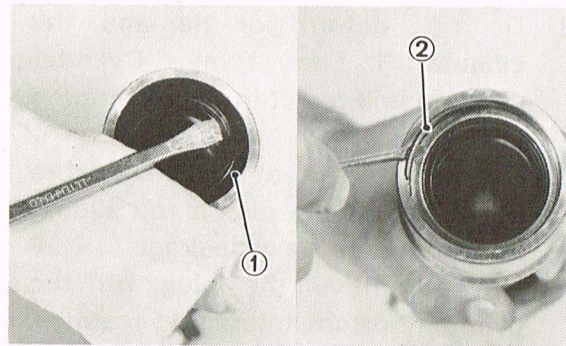

1. Dust seal

2. Snap ring

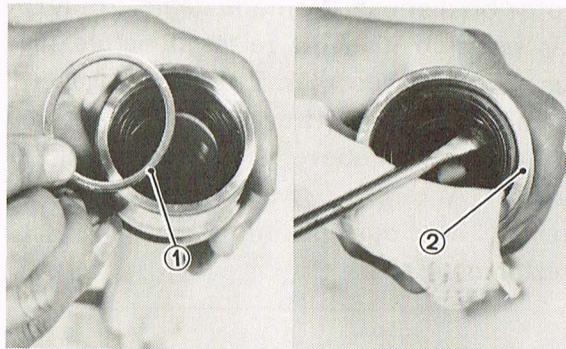

1. Washer

2. Oil seal

3. When reassembling, reverse the removal procedure taking care of following points:
  - a. Make sure all components are clean before reassembly.
  - b. Insert new oil seal "open" side down and dust seal (Manufacturer's marks up) using large socket and hammer.

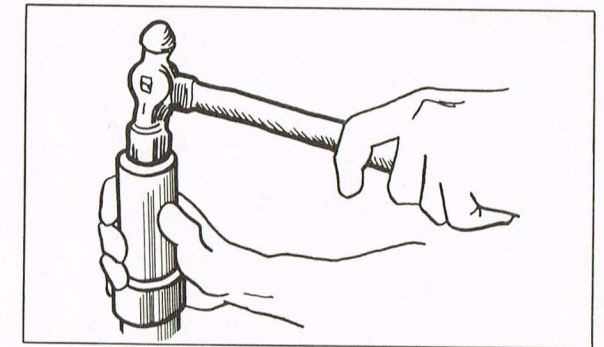

- c. Install the front forks so that they must be flush with the upper surface of the handle crown.
- d. Tightening torque:

Cylinder holding bolt:  
Under bracket pinch bolt:

2.3 m-kg (16 ft-lb)

#### NOTE:

Apply a holding agent, such as "LOCTITE" to threads of bolt.



## Steering Head

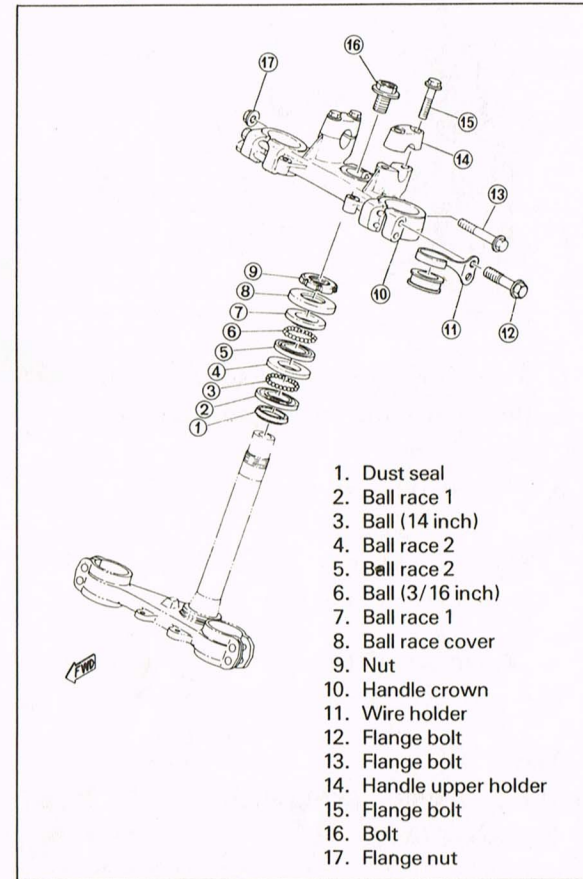

1. Dust seal
2. Ball race 1
3. Ball (14 inch)
4. Ball race 2
5. Ball race 2
6. Ball (3/16 inch)
7. Ball race 1
8. Ball race cover
9. Nut
10. Handle crown
11. Wire holder
12. Flange bolt
13. Flange bolt
14. Handle upper holder
15. Flange bolt
16. Bolt
17. Flange nut

### Inspection

1. Examine all the balls for pits or partial flatness. If any one is found defective, the entire set (including both races) should be replaced. If either race is pitted, shows rust spots, or is damaged in any way, replace both races and all balls.

#### Ball quantity/size:

Upper..... 2, 3/16 in  
Lower..... 19, 1/4 in

2. Examine dust seal under lowest race and replace if damaged.
3. Grease the lower ball race of the upper and lower assembly and arrange the balls around it. Then apply more grease and set the top race into place.

### NOTE:

Use medium-weight wheel bearing grease of quality manufacturer—preferably water-proof.

## Rear Shock (Monocross Suspension "DE CARBON" System)

### — WARNING: — READ CAREFULLY —

This shock absorber contains highly compressed nitrogen gas.

Read and understand the following information before handling the shock absorber. The manufacturer cannot be held responsible for property damage or personal injury that may result from improper handling.

1. Do not tamper with or attempt to open the cylinder assembly. Injury may result.
2. Do not subject shock absorber to an open flame or other high heat. This may cause the unit to explode due to excessive gas pressure.
3. Do not deform or damage the cylinder in any way. Cylinder damage will result in poor damping performance.
4. Handle it with great care, for a score or scratch in the piston rod sliding portion will cause oil leakage.
5. Never remove the plug on the cylinder bottom. Injury may result.

### Notes on disposal (Yamaha dealers only)

Gas pressure must be released before disposal of shock absorber. To do so, drill a 2 – 3 mm hole through the cylinder wall at a point 10 – 15 mm above the bottom of the cylinder. At this time, wear eye protection to prevent eye damage from escaping gas and/or metal chips.

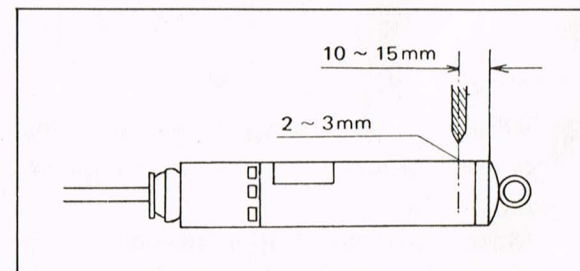

### — WARNING: —

To dispose of a damaged or worn-out shock absorber, take the unit to your Yamaha dealer for this disposal procedure.

### Rear shock absorber (Monocross suspension) removal

1. Remove the two bolts holding the fuel tank (petcock lever must be turned OFF). Lift up the tank holder and remove it. And remove the rear wheel.
2. Remove the cotter pin and nut. Remove the bolt securing the upper bracket to frame.
3. Remove the cotter pin and pull out the pivot shaft from the lower bracket.

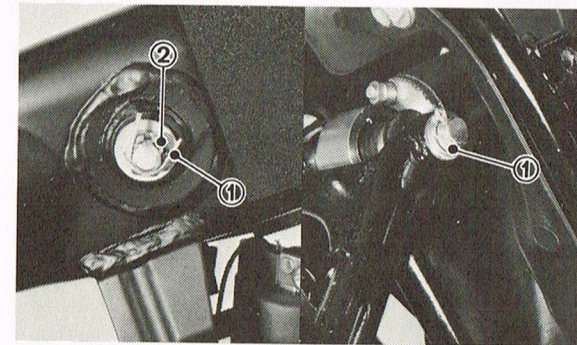

1. Cotter pin 2. Nut 1. Cotter pin

### NOTE:

Put a proper support under the engine to keep the machine from falling over.

4. Remove the rear shock absorber from the frame. (To remove, pull the rear shock backward while lifting up the frame.)

### NOTE:

- a. When removing the shock absorber, be careful not to bend the absorber rod.
- b. Take care so the two washers are not lost.

## Swing Arm

1. Grasp the ends of the arm and move from right to left to check for free play.

### Swing arm free play:

0 ~ 1 mm (0 ~ 0.04 in)

2. If free play is excessive, remove swing arm and replace swing arm bushings and bearings.

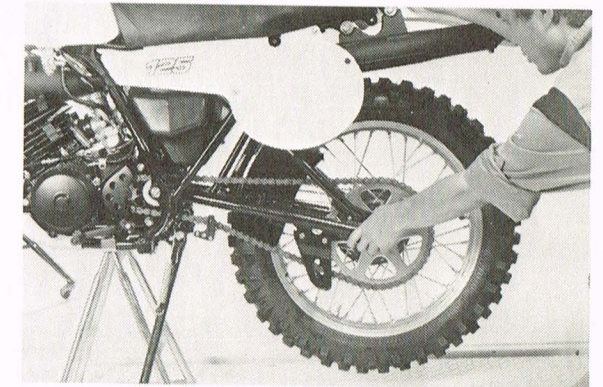

3. Check the swing arm for cracks. If there is any crack, repair or replace the swing arm, as required.

### NOTE:

When assembling, grease the following points.

1. Oil seal lips and inside of guard seal.
2. Inside of spacer.
3. Contact surfaces of bearing and bush.



# ELECTRICAL

## General information

The IT125H use a flywheel magneto to generate electrical current/voltage for the lighting system and uses CDI system for ignition. There are two coils attached to the magneto backing plate. The righthand coil supplies primary voltage to the ignition coil.

The lefthand coil provides alternating current (AC) for operation of the lights.

### NOTE:

If headlight filament burns out while engine is running, the taillamp filament may also burn out because of excess voltage. Always check taillight operation when replacing headlight.

## CIRCUIT DIAGRAM

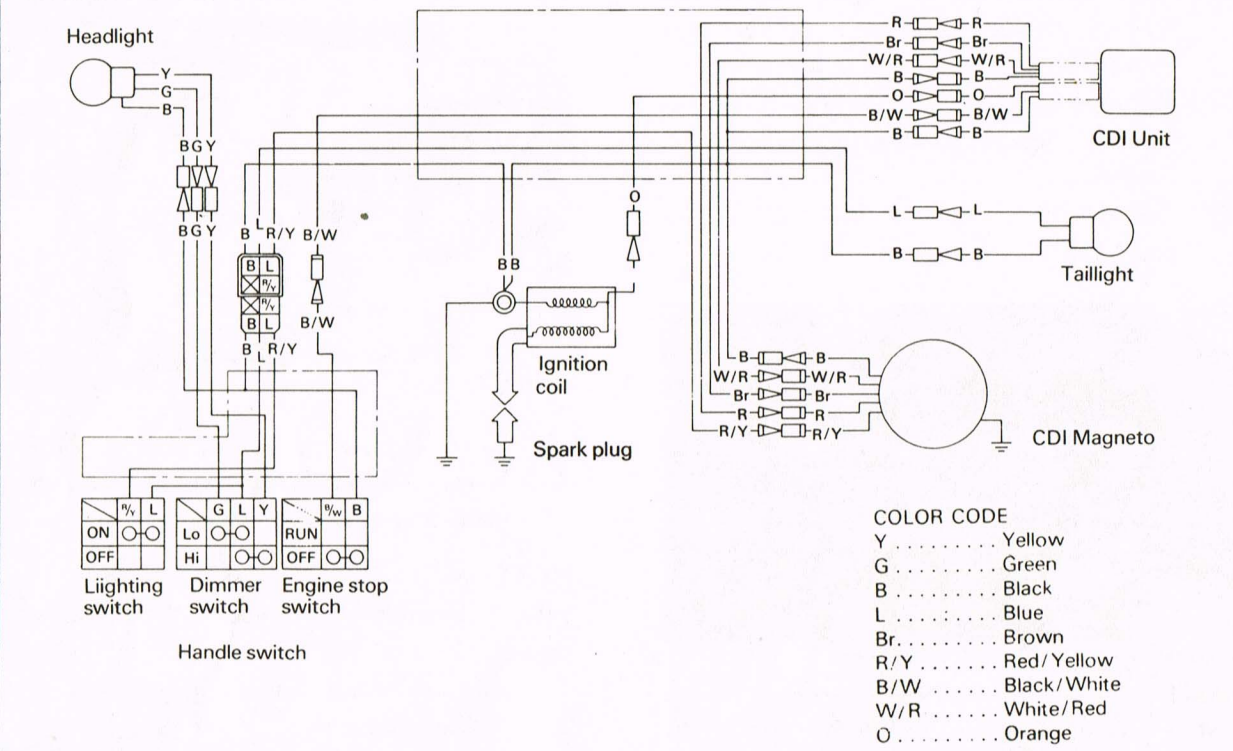

## IGNITION SYSTEM

### Troubleshooting:

- No spark is produced or weak.
- The engine starts but will not pick up speed.

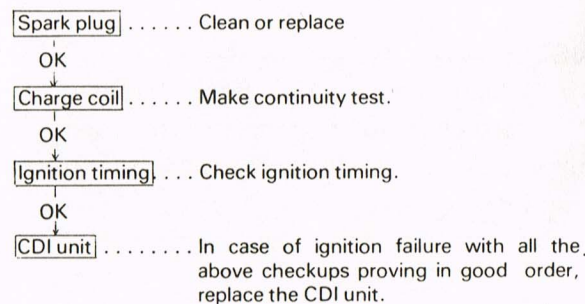
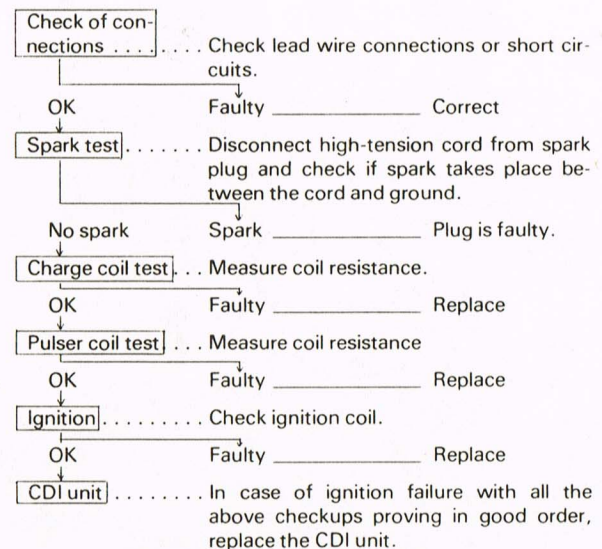

## Spark gap test

Remove the high tension wire from the spark plug cap, and as shown below, hold it 6 mm (0.23 in) off the plug. Kick the kick crank and check if spark takes place.

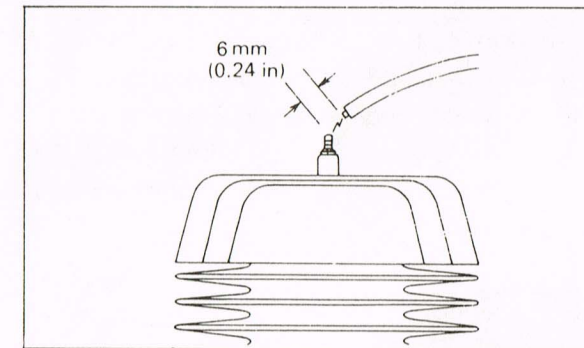

at 20°C (68°F)

Pulsar coil resistance (W/R-B):  
 $12.4\Omega \pm 10\%$   
 Charge coil resistance  
 (High speed) (R-B):  $13.6\Omega \pm 10\%$   
 Charge coil resistance  
 (Low speed) (Br-B):  $420\Omega \pm 10\%$

## Magneto coil resistance test

Measure the resistance of lighting coil, charge coil and pulser coil. If the resistance measured is off the specification below, the coil is considered to be shorted or to have a broken wire.

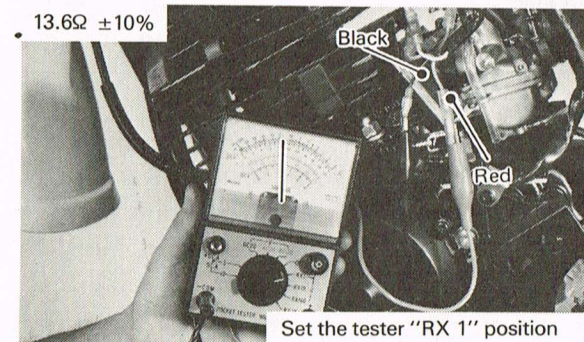
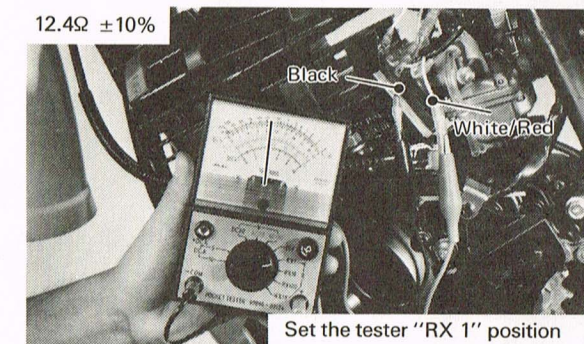

## Ignition coil resistance test

Use a pocket tester or equivalent ohmmeter to determine resistance and continuity of primary and secondary coil windings.

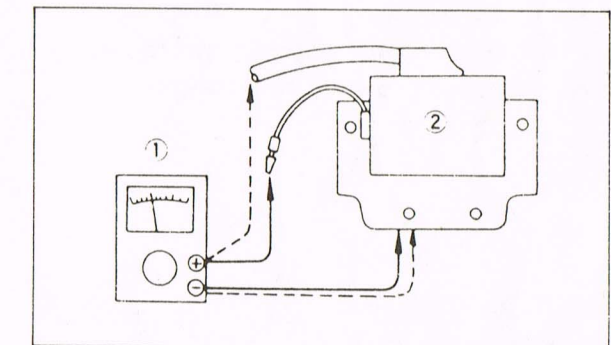

- Primary coil resistance check.
- Secondary coil resistance check.

at 20°C (68°F)

Primary coil resistance:  
 Use  $\Omega \times 1$  scale:  $1.0\Omega \pm 10\%$   
 Secondary coil resistance:  
 Use  $\Omega \times 100$  scales:  $5.9\text{ k}\Omega \pm 20\%$

Lee Waldie Craig Scott Chris Koira



## Lighting System

### Description

The lighting system consists of the lighting coil, headlight and taillight. Lighting coil in the flywheel magneto supply alternating current (A.C.) for the headlight, and taillight.

#### WARNING:

Use bulbs of the correct capacity for the headlight, and taillight which are directly connected to the flywheel magneto. If large capacity bulbs are used, the voltage will rise, shortening the life of bulbs. When the headlight beam switch is operated to change the beam from one to another, the headlight is designed to keep both bulbs burning during the change over. This is to protect other light bulbs from burning out as a result of turning off the headlight, even temporarily. If one of these light bulbs is burnt out while the machine is running, it will overload other bulbs and shorten their service life. Reduce engine speed and replace a burnt bulb as quickly as possible.

### A.C. circuit output test

With all A.C. light in operation the circuit will be balanced and the voltage will be the same at all points at a given r.p.m.

1. Switch Pocket Tester to "AC20V" position.
2. Connect positive (+) test lead to Red/Yellow connection and negative (-) test lead to black connection.
3. Connect Engine speed meter.
4. Start engine, turn on lights switch and check voltage at each engine speed in table below.

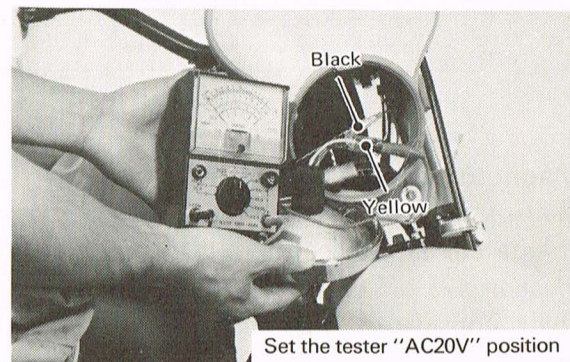

If measured voltage is too high or too low, check for bad connections, damaged wires, burned out bulbs or bulb capacities are too large throughout the A.C. lighting circuit.

Output voltage:  
5.0V or more/2,500r/min  
7.0 or less/8,000r/min

**NOTE:** \_\_\_\_\_  
Be sure to turn the lighting switch to ON.

**NOTE:** \_\_\_\_\_  
This voltage test can be made at any point throughout the A.C. lighting circuit and the readings should be the same as specified above.

Martin I Henry

### Lighting coil resistance check

If voltage is incorrect in A.C. lighting circuit, check the resistance of the yellow-red wire windings of the lighting coil.

1. Switch pocket tester to " $\Omega \times 1$ " position and zero meter.
2. Connect positive (+) test lead to Red/Yellow wire from magneto and negative (-) test lead to Blackwire. Read the resistance on ohms scale.



Lighting coil resistance:  
0.48Ω ± 10%



## CLEANING AND STORAGE

### Cleaning

Frequent thorough cleaning of your motorcycle will not only enhance its appearance but will improve general performance and extend the useful life of many components.

1. Before cleaning the machine:
  - a. Block off end of exhaust pipe to prevent water entry; a plastic bag and strong rubber band may be used.
  - b. Remove air cleaner or protect it from water with plastic covering.
  - c. Make sure spark plug(s), fuel tank cap, transmission oil filler cap are properly installed.
2. If engine case is excessively greasy, apply degreaser with a paint brush. Do not apply degreaser to chain, sprockets, or wheel axles.
3. Rinse dirt and degreaser off with garden hose, using only enough hose pressure to do the job. Excessive hose pressure may cause water seepage and contamination of wheel bearings, front forks, brake drums, and transmission seals. Many expensive repair bills have resulted from improper high pressure detergent applications such as those available in coin-operated car washers.
4. Once the majority of the dirt has been hosed off, wash all surfaces with warm water and mild, detergent-type soap. An old tooth brush or bottle brush is handy to reach hard-to-get-to places.
5. Rinse machine off immediately with clean water and dry all surfaces with a chamois, clean towel, or soft absorbent cloth.
6. Immediately after washing, remove excess moisture from chain and lubricate to prevent rust.
7. Chrome-plated parts such as handlebars, rims, spokes, forks, etc., may be further cleaned with automotive chrome cleaner.
8. Clean the seat with a vinyl upholstery cleaner to keep the cover pliable and glossy.

9. Automotive-type wax may be applied to all painted and chrome-plate dustfaces. Avoid combination cleaner-waxes. Many contain abrasive which may mar paint or protective finish on fuel and oil tanks.
10. After finishing, start the engine immediately and allow to idle for several minutes.

### NOTE:

Water may enter the air cleaner case during washing the machine. Be sure to remove the grommet attached to the lower left part of the case and drain the water, as required.

### Storage

Long term storage (60 days or more) of your motorcycle will require some preventive procedures to insure against deterioration. After cleaning machine thoroughly, prepare for storage as follows:

1. Drain fuel tanks, fuel lines, and carburetor float bowl(s).
2. Remove empty fuel tank, pour a cup of SAE 10W/30 oil in tank, shake tank to coat inner surfaces thoroughly and drain off excess oil. Re-install tank.
3. Remove spark plug(s), pour about one tablespoon of SAE 10W/30 oil in spark plug hole(s) and re-install spark plugs. Kick engine over several times (with ignition off) to coat cylinder walls with oil.
4. Remove drive chain. Clean thoroughly with solvent and lubricate. Re-install chain or store in a plastic bag (tie to frame for safe-keeping).
5. Lubricate all control cables.
6. Block up frame to raise both wheels off ground.
7. Tie a plastic bag over exhaust pipe outlet(s) to prevent moisture from entering.
8. If storing in humid or salt-air atmosphere, coat all exposed metal surfaces with a light film of oil. Do not apply oil to rubber parts or seat cover.

### NOTE:

Make any necessary repairs before storing the motorcycle.

## SPECIFICATIONS

### General

Item	Model	IT125H
Model (I.B.M. No.)		3R9
Frame I.D. & Starting Number		3R9-050101
Engine I.D. & Starting Number		3R9-050101
Dimensions:		
Overall length		2,105 mm (82.9 in)
Overall width (standard)		890 mm (35.0 in)
Overall height (standard)		1,130 mm (44.5 in)
Seat height		850 mm (33.5 in)
Wheelbase		1,365 mm (53.7 in)
Minimum ground clearance		300 mm (11.8 in)
Weight:		
Net weight		91.5 kg (202 lbs)

### Engine

Description:		Air cool 2-stroke gasoline engine, torque induction
Engine type		3R9
Engine model		123 cc (7.51 cu. in)
Displacement		56 mm × 50 mm (2.2 in × 1.97 in)
Bore × Stroke		8.1 : 1
Compression ratio		Primary kick starter
Starting system		Capacitor Discharge Ignition
Ignition system		Mixed gas (20 : 1)
Lubrication system		
Cylinder head:		
Combustion chamber volume		9.0 cc (0.55 cu. in)
Combustion chamber type		Dome and squish
Head gasket thickness		1.0 mm (0.04 in)
Cylinder:		
Material		Aluminum alloy with cast iron
Bore size		56.00 ~ 56.02 mm (2.204 ~ 2.205 in)
Taper limit		0.05 mm (0.002 in)
Out of round limit		0.01 mm (0.004 in)
Piston:		
Piston skirt clearance		0.045 ~ 0.050 mm (0.0018 ~ 0.0020 in)
Piston over size		56.25 mm, 56.50 mm, 56.75 mm, 57.00 mm
Piston pin outside diameter × Length		16 × 47 mm (0.063 × 1.85 in)
Piston rings:		
Piston ring design (Top/Second)		Keystone/Plain
Ring end gap (Installed) (Top/Second)		0.3 ~ 0.5 mm (0.012 ~ 0.019 in)
Ring groove side clearance (Top)		0.02 ~ 0.06 mm (0.0008 ~ 0.0024 in)
Ring groove side clearance (Second)		0.03 ~ 0.07 mm (0.0012 ~ 0.0028 in)
Small end bearing: Type		Needle bearing
Big end bearing: Type		Needle bearing



<b>Crankshaft:</b> Crankshaft assembly width (F) Crankshaft deflection (A) Connecting rod big end side clearance (C) Connecting rod small end deflection (S) Crank pin outside diameter × Length Crank bearing type (Left) (Right) Crank oil seal type (Left) (Right)	55.90 ~ 55.95 mm (2.20 ~ 2.203 in) 0.03 mm (0.0012 in) 0.2 ~ 0.7 mm (0.008 ~ 0.028 in) 0.8 ~ 2.0 mm (0.03 ~ 0.08 in) 22 mm × 54.4 mm (0.89 × 2.14 in) 6205C4SH 6304C3SH MHSA 25 × 40 × 8 MHSD 28 × 40 × 8
<b>Clutch:</b> Clutch type Clutch operating mechanism Primary reduction ratio & method Friction plate— Thickness/Quantity —Wear limit Clutch spring— Free length/Quantity —Wear limit Clutch housing axial play (wear limit) Push rod bending limit	Wet, multiple dist type Inner pash type, cam exle 71/22 (3.227), Gear 3.0 mm (0.12 in) × 5 pcs 2.7 mm (0.106 in) 34 mm (1.34 in) × 5 pcs 33 mm (1.30 in) 0.05 ~ 0.13 mm (0.002 ~ 0.005 in) 0.15 mm (0.006 in)
<b>Transmission:</b> Type Gear ratio 1st (Teeth) (Ratio) 2nd 3rd 4th 5th 6th Transmission gear oil quantity & type Pediodic change Over haul Secondary reduction ratio & method	Constant mesh 6 speed 34/11 (3.090) 31/15 (2.066) 27/18 (1.500) 25/21 (1.190) 23/23 (1.000) 21/25 (0.840) 600 cc ~ 700 cc (0.65 ~ 0.75 Us qt) 700 cc ~ 800 cc (0.75 ~ 0.85 Us qt) Yamalube 4-cycle oil SAE 10W/30 "SE" motor oil 46/12 (3.833), Chain
<b>Intake:</b> Air cleaner— Type/Quantity —Oil grade Induction system	Wet foam rubber/ 1pc Air cooled 2-cycle engine oil Reed valve
<b>Reed valve:</b> Type Bending limit Valve lift	V type 0.3 mm (0.012 in) 8.3 mm (0.327 in)
<b>Carburetor:</b> Type & manufacturer Main jet (M.J.) Air jet (A.J.) Jet needle-clip position (J.N.) Needle jet (N.J.) Cutaway (C.A.) Pilot jet (P.J.) Air screw (turns out) (A.S.) Starter jet (G.S.) Float level (F.L.)	VM30SS/Mikuni #200 Ø2-5 6DP19-2 P-4 2.0 35 1-3/4 #80 16.4 mm (0.65 in)

## Chassis

<b>Frame:</b> Frame design	Tubular steel semi-double cradle
<b>Steering system:</b> Caster Trail Number & size of balls in steering head: Upper race Lower race Lock to lock angle	28°30' 120 mm (4.72 in) Steel ball 3/16 in × 22 pcs 1/4 in × 19 pcs 98°
<b>Front suspension:</b> Type Damper type Front fork travel Front fork springs: Free length Wire diameter × Winding diameter Inner tube outside diameter Oil seal type Front fork oil quantity & type	Telescopic type Coil spring oil damper 200 mm (7.87 in) 541.5 mm (21.3 in) 3.8 × 26.4 mm (0.15 × 1.03 in) 35 mm (1.38 in) SD-32-44-10.5 Yamaha fork oil 10 wt 258 cc (8.7 oz), SAE # 10 motor oil
<b>Rear suspension:</b> Type Gas pressure Gas properties Absorber stroke Wheel travel Compression spring: Free length Number of windings Swiing arm free play PiVot shaft— outside diameter	Monocross suspension/ Gas-oil damper coil spring 12 kg/cm <sup>3</sup> Nitrogen gas 99 mm (3-9 in) 200 mm (7.9 in) 205 mm (8.07 in)/66 mm (2.6 in) 13.2/5.5 0 ~ 1 mm (0.04 in) 12 mm (0.47 in)
<b>Fuel tank:</b> Capacity Fuel grade	8.5ℓ (8.9 Us qt) Leaded gasoline
<b>Wheel:</b> Tire size (Front) (Rear) Tire pressure (STD) (Front) (Rear) Rim size (Front) (Rear) Rim run out limit (Front/Rear)— Vertical — Lateral Secondary drive chain type: Type Number of links Chain free play	3.00-21-4PR/Bridistone 4-10-18-4PR/Bridistone 1.0 kg/cm <sup>2</sup> (14 psi) 1.0 kg/cm <sup>2</sup> (14 psi) 1.60-21 1.85-18 2 mm (0.079 in) 2 mm (0.079 in) DK520DS 100 links 40 ~ 45 mm (1.57 ~ 1.77 in)



<b>Brake:</b>	
<b>Front brake:</b>	
Type	Drum (Leading trailing)
Drum diameter (Limit)	110 mm (4.33 in)
Shoe diameter × Width	110 mm × 25 mm (4.33 in × 1.0 in)
Shoe spring free length	34.5 mm (1.36 in)
Lining thickness/Wear limit	4 mm (0.16 in)/2 mm (0.08 in)
<b>Rear brake:</b>	
Type	Drum (Leading trailing)
Drum diameter	130 mm (5.12 in)
Shoe diameter × Width	130 mm × 28 mm (5.12 in × 1.1 in)
Shoe spring free length	36.5 mm (1.44 in)
Lining thickness/Wear limit	4 mm (0.16 in)/2 mm (0.08 in)

### Electrical

<b>Ignition system:</b>	
Type	Flywheel magneto (capacitor discharge ignition)
Model/Manufacturer	F03T20072/Mitsubishi
Pulser coil resistance (W/R-B)	12.4Ω ± 10%
Charge coil resistance	
Low speed (Br-B):	420Ω ± 10%
High Speed (R-B):	13.6Ω ± 10%
Lighting out put	5V or more/2,500 r/min 7V or less/8,000 r/min
Lighting coil resistance (R/Y-B)	0.48Ω ± 10%
Flywheel puller thread size	27 mm (1.06 in)
<b>Ignition timing:</b>	B.T.D.C. 18° at 2,000 r/min (- 1.5 mm ± 0.15 mm)
<b>Ignition coil:</b>	
Model/Manufacturer	F6T41174/Mitsubishi
Spark gap	6 mm
Primary winding resistance	1.0Ω ± 10%
Secondary winding resistance	5.9KΩ ± 10%
<b>Spark plug:</b>	
Type/Manufacture	N-2G/Champion
Spark plug gap	0.7 mm (0.028 in)
<b>C.D.I. unit/Manufacture</b>	F08T01172/Mitsubishi
<b>Headlight</b>	6V, 25W/25W
<b>Taillight</b>	6V, 5.3W

### Tightening torque

Engine	Tightening torque
Bearing cover plate (drive axle)	M6 0.8 m-kG (6 ft-lb)*
Plate cover (main axle)	M6 1.0 m-kG (7 ft-lb)*
Crankcase	M6 0.5 m-kG (4 ft-lb)
Drive sprocket	M16 5.5 m-kG (40 ft-lb) Lock washer
Drain plug	M12 2.0 m-kG (14 ft-lb)
Stopper lever assembly	M6 1.4 m-kG (10 ft-lb)*
Crankholder	M8 1.6 m-kG (12 ft-lb)*
Push lever axle	M8 0.8 m-kG (6 ft-lb)*
Shifter adjust screw	M8 3.0 m-kG (22 ft-lb) Lock washer
Primary drive gear	M12 5.5 m-kG (40 ft-lb)
Clutch boss	M14 5.5 m-kG (40 ft-lb) Lock washer
Clutch spring	M5 0.6 m-kG (4 ft-lb)
Push rod 1	M6 1.0 m-kG (7 ft-lb)
Crankcase cover	M6 0.9 m-kG (6 ft-lb)
Kick crank	M8 2.5 m-kG (18 ft-lb)
Cylinder	M10 3.5 m-kG (25 ft-lb)
Cylinder head	M8 2.5 m-kG (18 ft-lb)
Spark plug	M14 2.5 m-kG (18 ft-lb)
Magnet base	M6 0.8 m-kG (6 ft-lb)
Magneto rotor	M12 7.0 m-kG (50 ft-lb)
Intake manifold	M6 0.8 m-kG (6 ft-lb)
Stud bolt (Cylinder head)	M8 2.4 m-kG (18 ft-lb)
Stud bolt (Crankcase)	M10 4.5 m-kG (32 ft-lb)

Lee Waldie Craig Scott Chris Koira

Chassis	Tightening torque
Front wheel axle	M10 4.0 m-kG (28 ft-lb)
Rear wheel axle	M14 8.5 m-kG (60 ft-lb)
Rear wheel sprocket	M10 4.0 m-kG (28 ft-lb)
Engine mount — Front	M8 2.5 m-kG (18 ft-lb)
— Rear, upper	M8 2.5 m-kG (18 ft-lb)
— Rear, lower	M10 4.0 m-kG (28 ft-lb)
Pivot shaft	M12 4.3 m-kG (30 ft-lb)
Handle crown — Inner tube	M10 3.5 m-kG (25 ft-lb)
— Steering shaft	M8 2.4 m-kG (18 ft-lb)
— Stem bolt	M14 5.5 m-kG (40 ft-lb)
Handle crown — Handle holder	M8 1.4 m-kG (10 ft-lb)
Rear shock absorber — frame	M8 2.5 m-kG (18 ft-lb)
Rear hub stud bolt	M10 4.0 m-kG (28 ft-lb)

\* Apply holding agent, such as "LOCTITE" to threads of bolt.



**CABLE ROUTING DIAGRAM**

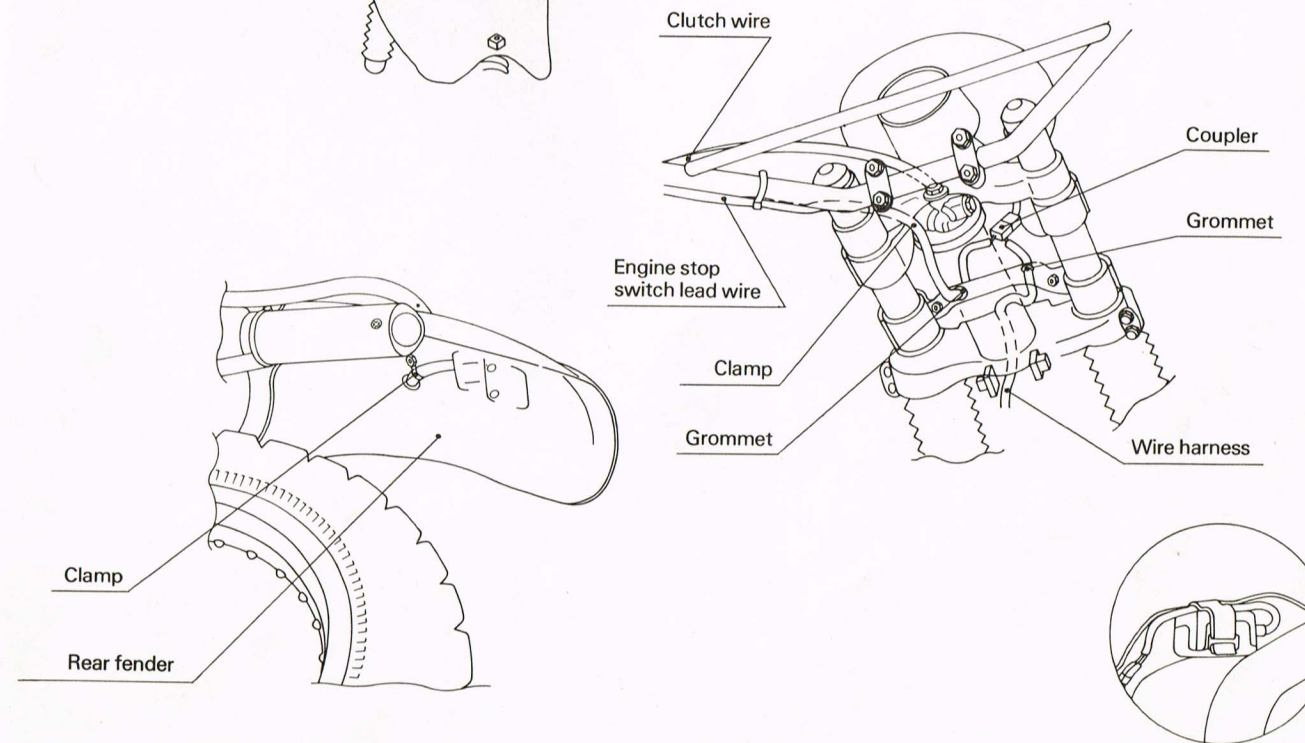
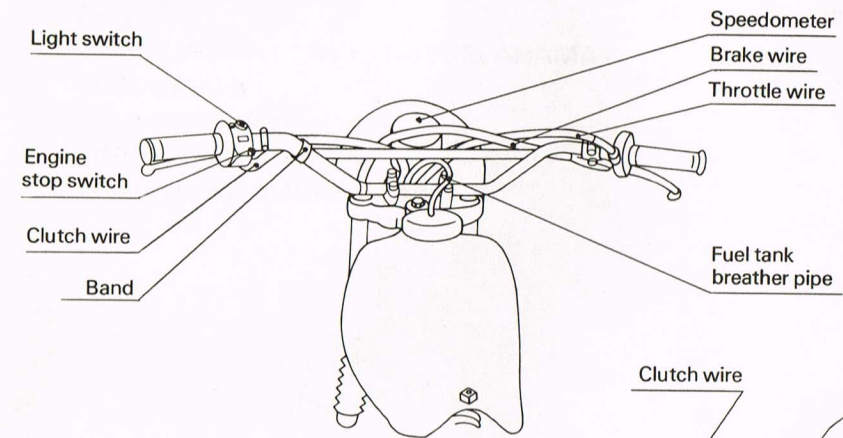
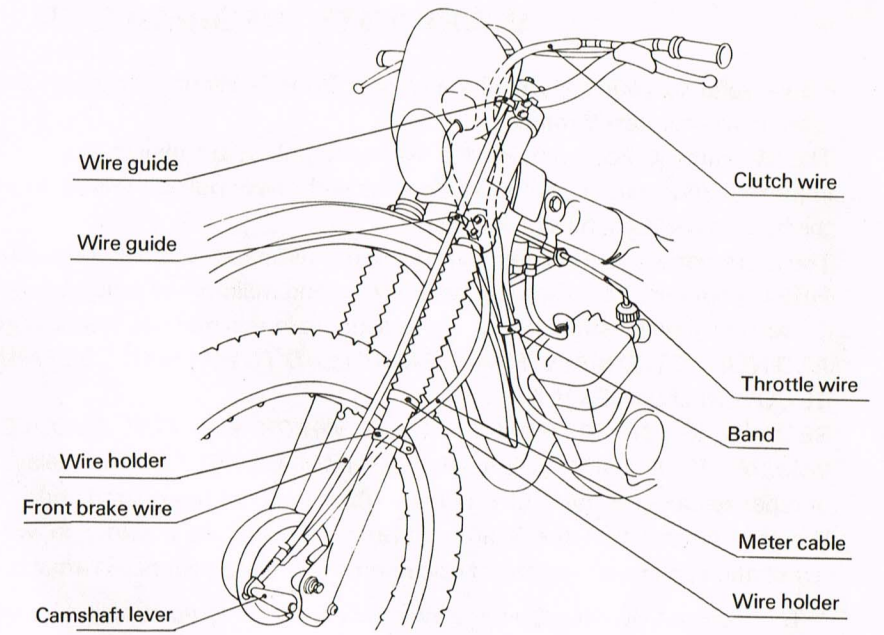
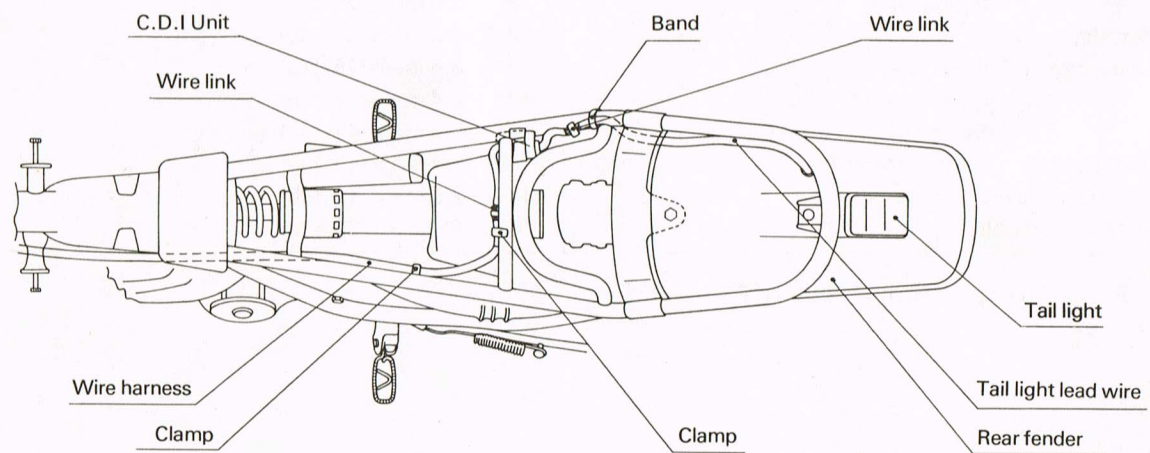
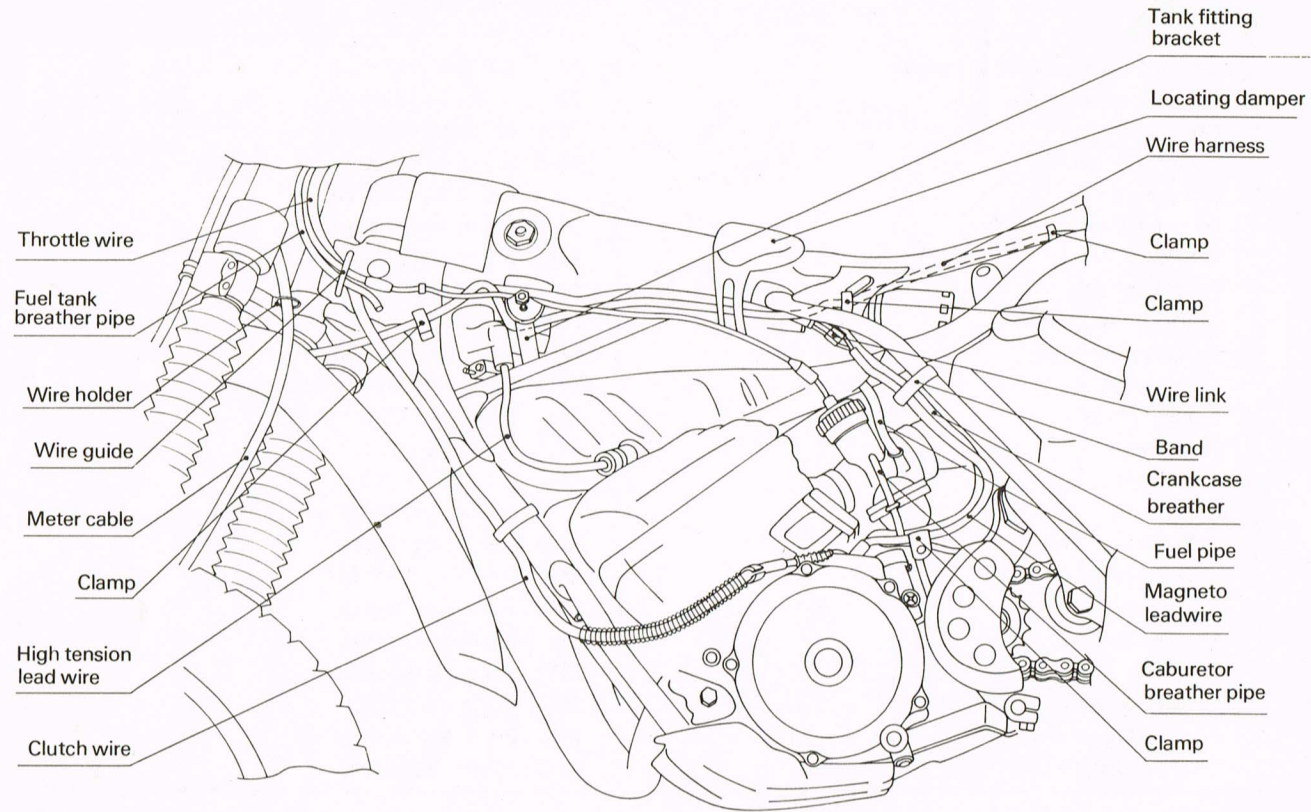



## WARRANTY INFORMATION

Please refer to your copy of the Yamaha Owner's Warranty Guide\* for details of the warranty offered on your new Yamaha.

The Warranty Guide contains the warranty policy, an explanation of the warranty, and other important information. Becoming familiar with these policies will be to your advantage in making the best use of Yamaha's programs.

There are certain requirements which you must meet in order to qualify for warranty coverage. FIRST, your new Yamaha must be operated and maintained properly, as explained in this manual. If you have any questions about any procedure in this manual, please consult your dealer. ABUSE AND NEGLECTED MAINTENANCE MAY LEAD TO MECHANICAL FAILURES WHICH CANNOT BE COVERED UNDER WARRANTY.

SECOND, IF ANY PROBLEMS OCCUR WHICH YOU FEEL SHOULD BE COVERED UNDER WARRANTY NOTIFY YOUR DEALER IMMEDIATELY. Don't delay, as small problems left unrepaired can become large problems which may not be covered under warranty.

We recommend that the Warranty Guide be used as a folder in which you may keep your registration and other important documents related to your new Yamaha.

\* The Yamaha Owner's Owner's Warranty Guide is to be supplied by your Yamaha dealer at the time of purchase. If you did not receive one, or have lost yours, you may obtain extra copies upon request from your Yamaha dealer or by writing to:

**YAMAHA MOTOR CORPORATION, U.S.A.**  
P.O.Box 6555  
6555 Katella Ave.  
Cypress California 90630  
Attn: Warranty Department