

**YAMAHA**

**XTZ660 ('91)**

3YF-ME1

**SERVICE MANUAL**

---

## NOTICE

This manual was written by the Yamaha Motor Company primarily for use by Yamaha dealers and their qualified mechanics. It is not possible to put an entire mechanic's education into one manual, so it is assumed that persons using this book to perform maintenance and repairs on Yamaha motorcycle have a basic understanding of the mechanical concepts and procedures inherent in motorcycle repair technology. Without such knowledge, attempted repairs or service to this model may render it unfit to use and/or unsafe.

Yamaha Motor Company, Ltd. is continually striving to improve all models manufactured by Yamaha. Modifications and significant changes in specifications or procedures will be forwarded to all Authorized Yamaha dealers and will, where applicable, appear in future editions of this manual.

### PARTICULARLY IMPORTANT INFORMATION

This material is distinguished by the following notation.



The Safety Alert Symbol means ATTENTION! BECOME ALERT! YOUR SAFETY IS INVOLVED!

#### **WARNING**

Failure to follow WARNING instructions could result in severe injury or death to the motorcycle operator, a bystander, or a person inspecting or repairing the motorcycle.

#### **CAUTION:**

A CAUTION indicates special precautions that must be taken to avoid damage to the motorcycle.

#### **NOTE:**

A NOTE provides key information to make procedures easier or clearer.



# HOW TO USE THIS MANUAL

## CONSTRUCTION OF THIS MANUAL

This manual consists of chapters for the main categories of subjects. (See "Illustrated symbols")

- 1st title ① : This is a chapter with its symbol on the upper right of each page.
- 2nd title ② : This title appears on the upper of each page on the left of the chapter symbol. (For the chapter "Periodic inspection and adjustment" the 3rd title appears.)
- 3rd title ③ : This is a final title.

## MANUAL FORMAT

All of the procedures in this manual are organized in a sequential, step-by-step format. The information has been compiled to provide the mechanic with an easy to read, handy reference that contains comprehensive explanations of all disassembly, repair, assembly, and inspections.

A set of particularly important procedure ④ is placed between a line of asterisks "\*" with each procedure preceded by "•".

## IMPORTANT FEATURES

- Data and a special tool are framed in a box preceded by a relevant symbol ⑤.
- An encircled numeral ⑥ indicates a part name, and an encircled alphabetical letter data or an alignment mark ⑦, the others being indicated by an alphabetical letter in a box ⑧.
- A condition of a faulty component will precede an arrow symbol and the course of action required the symbol ⑨.

## EXPLODED DIAGRAM

Each chapter provides exploded diagrams before each disassembly section for ease in identifying correct disassembly and assembly procedures.

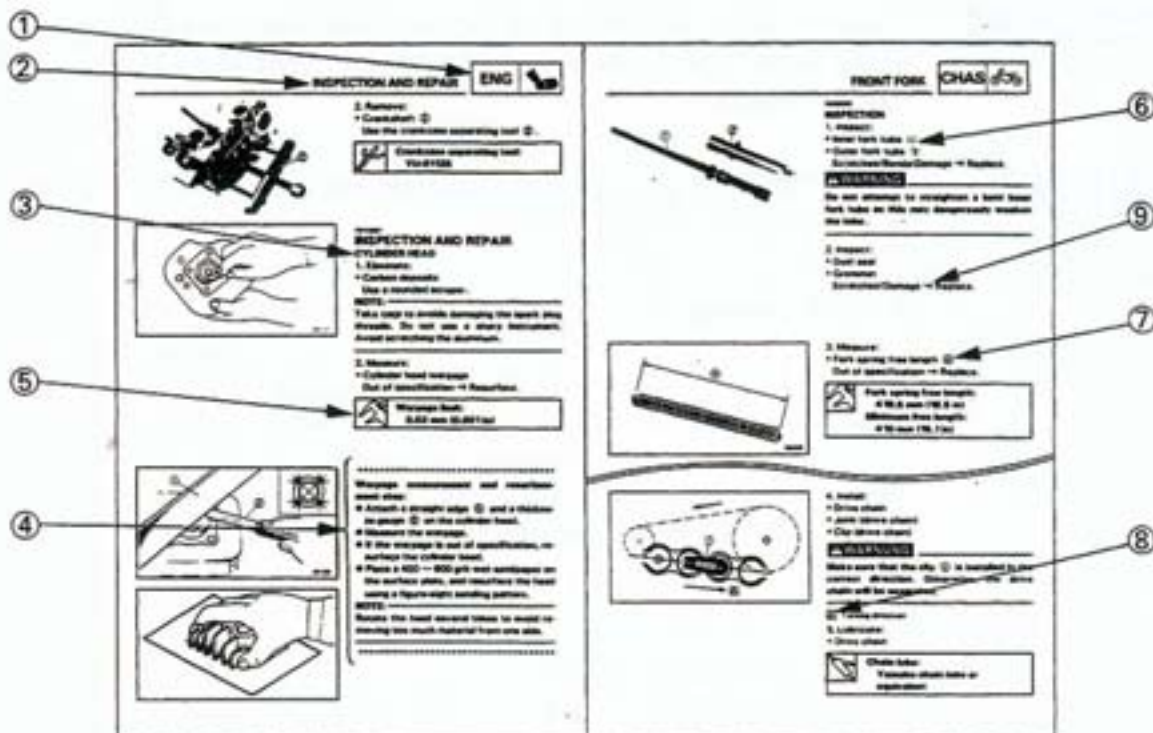

## ILLUSTRATED SYMBOLS (Refer to the illustration)

Illustrated symbols ① to ⑨ are designed as thumb tabs to indicate the chapter's number and content.

- ① General information
- ② Specifications
- ③ Periodic inspection and adjustment
- ④ Engine
- ⑤ Cooling system
- ⑥ Carburetion
- ⑦ Chassis
- ⑧ Electrical
- ⑨ Troubleshooting

Illustrated symbols ⑩ to ⑯ are used to identify the specifications appearing in the text.

- ⑩ Filling fluid
- ⑪ Lubricant
- ⑫ Special tool
- ⑬ Tightening
- ⑭ Wear limit, clearance
- ⑮ Engine speed
- ⑯  $\Omega$ , V, A









Illustrated symbols ⑰ to ⑳ in the exploded diagram indicate grade of lubricant and location of lubrication point.

- ⑰ Apply engine oil
- ⑱ Apply gear oil
- ⑲ Apply molybdenum disulfide oil
- ⑳ Apply wheel bearing grease
- ㉑ Apply lightweight lithium-soap base grease
- ㉒ Apply molybdenum disulfide grease
- ㉓ Apply locking agent (LOCTITE®)





# INDEX

GENERAL INFORMATION	
	GEN INFO <b>1</b>
SPECIFICATIONS	
	SPEC <b>2</b>
PERIODIC INSPECTION AND ADJUSTMENT	
	INSP ADJ <b>3</b>
ENGINE OVERHAUL	
	ENG <b>4</b>
COOLING SYSTEM	
	COOL <b>5</b>
CARBURETION	
	CARB <b>6</b>
CHASSIS	
	CHAS <b>7</b>
ELECTRICAL	
	ELEC <b>8</b>
TROUBLESHOOTING	
	TRBL SHTG <b>9</b>

---

## CHAPTER 1. GENERAL INFORMATION

<b>MOTORCYCLE IDENTIFICATION</b> .....	A-8
VEHICLE IDENTIFICATION NUMBER (For CNR, E) .....	A-8
FRAME SERIAL NUMBER (Except for CNR, E) .....	A-8
ENGINE SERIAL NUMBER .....	A-8
<b>IMPORTANT INFORMATION</b> .....	A-8
PREPARATION FOR REMOVAL AND DISASSEMBLY .....	A-8
ALL REPLACEMENT PARTS .....	A-9
GASKETS, OIL SEALS, AND O-RINGS .....	A-9
LOCK WASHERS/PLATES AND COTTER PINS .....	A-9
BEARING AND OIL SEALS .....	A-9
CIRCLIPS .....	A-9
<b>SPECIAL TOOLS</b> .....	A-9
FOR TUNE UP .....	A-9
FOR ENGINE SERVICE .....	A-10
FOR CHASSIS SERVICE .....	A-12
FOR ELECTRICAL COMPONENTS .....	A-12



**GENERAL INFORMATION**



**MOTORCYCLE IDENTIFICATION  
VEHICLE IDENTIFICATION NUMBER  
(For CNR, E)**

The vehicle identification number ① is stamped into the right side of the steering head.

Starting serial number:  
JYA3YFS0\*MA029101

**FRAME SERIAL NUMBER  
(Except for CNR, E)**

The frame serial number ① is stamped into the right side of the steering head.

Starting serial number:  
XTZ660...3YF-000101 (A)(B)(D)(DK)  
(F)(GB)(GR)(I)  
(N)(NL)(PRT)  
(S)(SF)  
XTZ660...4BW-000101 (A)(CH)



**ENGINE SERIAL NUMBER**

The engine serial number ① is stamped into the elevated part of the right rear section of the engine.

Starting serial number:  
XTZ660...3YF-000101 (A)(B)(D)(DK)  
(F)(GB)(GR)(I)  
(N)(NL)(PRT)  
(S)(SF)  
XTZ660...3YF-029101 (CNR)(E)  
XTZ660...4BW-000101 (A)(CH)

**NOTE:**

- The first three digits of these numbers are for model identifications; the remaining digits are the unit production number.
- Designs and specifications are subject to change without notice.



IMPORTANT INFORMATION

PREPARATION FOR REMOVAL AND  
DISASSEMBLY

1. Remove all dirt, mud, dust, and foreign material before removing and disassembling.



2. Use proper tools and cleaning equipment. Refer to "SPECIAL TOOL."



3. When disassembling the motorcycle, keep mated parts together. This includes gears, cylinders, pistons, and other mated parts that have been "mated" through normal wear. Mated parts must be reused as an assembly or replaced.



4. During the motorcycle disassembly, clean all parts and place them in trays in the order of disassembly. This will speed up assembly time and help assure that all parts are correctly reinstalled.

5. Keep away from fire.







## ALL REPLACEMENT PARTS

1. Use only genuine Yamaha parts for all replacements. Use oil and / or grease recommended by Yamaha for assembly and adjustment. Other brands may be similar in function and appearance, but inferior in quality.

## GASKETS, OIL SEALS, AND O-RINGS

1. All gaskets, seals and O-rings should be replaced when an engine is overhauled. All gasket surfaces, oil seal lips and O-rings must be cleaned.
2. Properly oil all mating parts and bearings during reassembly. Apply grease to the oil seal lips.

## LOCK WASHERS/PLATES AND COTTER PINS

1. All lock washers/plates ① and cotter pins must be replaced when they are removed. Lock tab(s) should be bent along the bolt or nut flat(s) after the bolt or nut has been properly tightened.

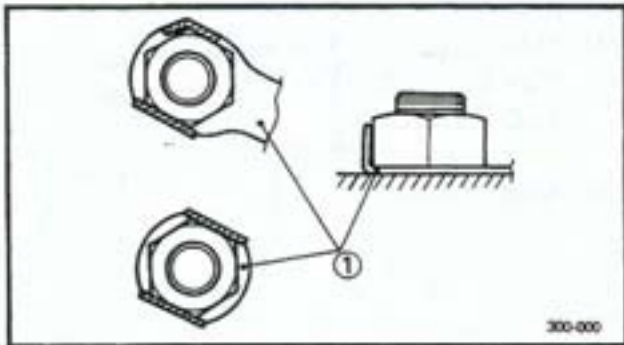

## BEARINGS AND OIL SEALS

1. Install the bearing(s) and oil seal(s) with their manufacturer's marks or numbers facing outward. (In other words, the stamped letters must be on the side exposed to view.) When installing oil seal(s), apply a light coating of light-weight lithium base grease to the seal lip(s). Oil the bearings liberally when installing.

① Oil seal

### CAUTION:

Do not use compressed air to spin the bearings dry. This causes damage to the bearing surfaces.

① Bearing

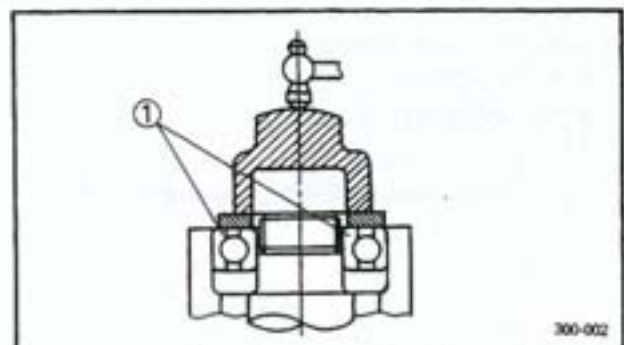
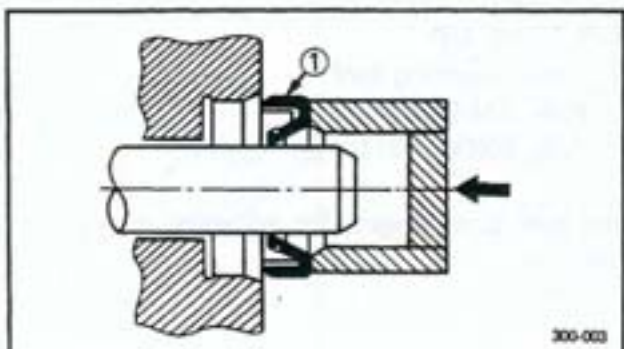

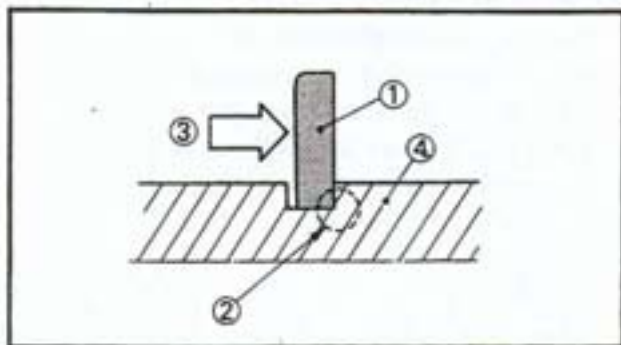

## CIRCLIPS

- All circlips should be inspected carefully before reassembly. Always replace piston pin clips after one use. Replace distorted circlips. When installing a circlip (1), make sure that the sharp-edged corner (2) is positioned opposite to the thrust (3) it receives. See the sectional view.

(4) Shaft

## SPECIAL TOOLS

The proper special tools are necessary for complete and accurate tune-up and assembly. Using the correct special tool will help prevent damage caused by the use of improper tools or improvised techniques.

The shape and part number used for the special tool differ by country, so two types are provided. Refer to the list provided to avoid errors when placing an order.

P/N. YM- □□□□□, YU- □□□□□ } For  
YS- □□□□□, YK- □□□□□ } US, CDN  
ACC-□□□□□

P/N. 90890-□□□□□ } Except for  
US, CDN

## FOR TUNE UP

- Valve adjusting tool  
P/N. YM-08035-①  
P/N. 90890-01311-②

This tool is necessary for adjusting the valve clearance.

- Inductive tachometer  
P/N. YU-08036-A-①  
P/N. 90890-03113-②

This tool is needed for detecting engine rpm.

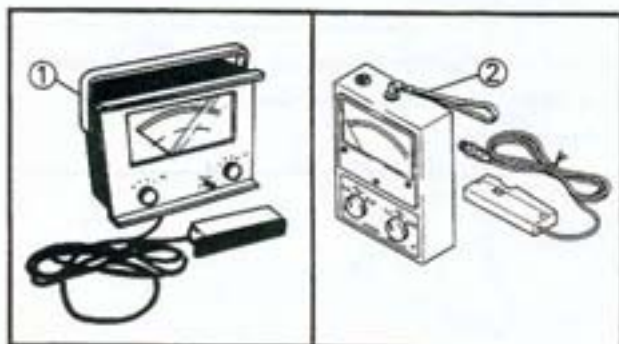
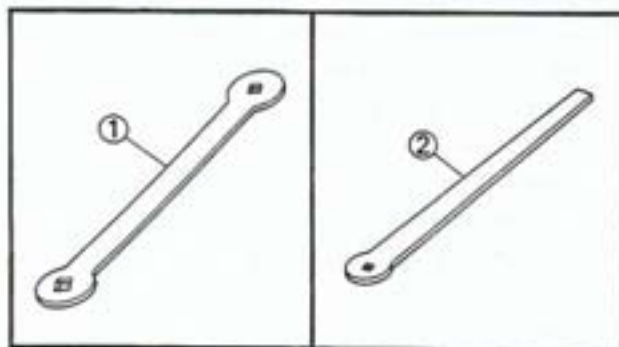



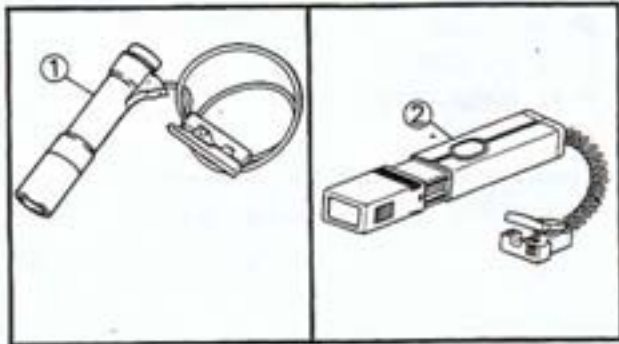

3. Inductive timing light  
P/N. YM-33277-A-①  
P/N. 90890-03141-②

This tool is necessary for checking ignition timing.

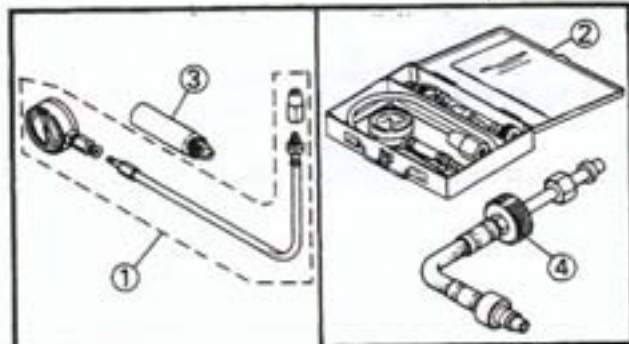

4. Compression gauge  
P/N. YU-33223-①  
P/N. 90890-03081-②  
Adapter (M12)  
P/N. YU-33223-3-③  
P/N. 90890-04082-④

These gauges are used to measure the engine compression.

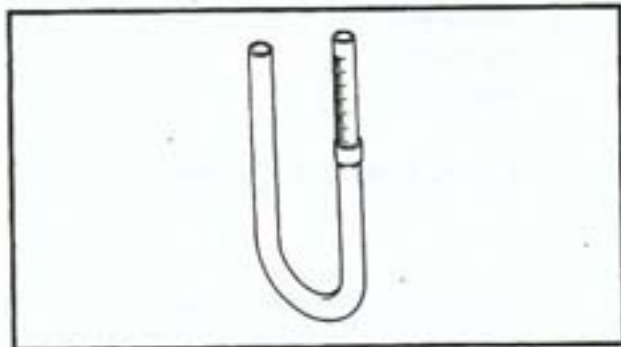

5. Fuel level gauge  
P/N. YM-01312-A  
P/N. 90890-01312

This gauge is used to measure the fuel level in the float chamber.

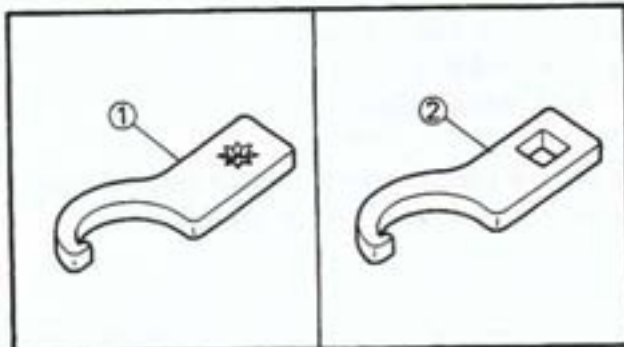

6. Steering nut wrench  
P/N. YM-38520-①  
P/N. 90890-01443-②

This tool is used to adjust the spring preload of rear shock absorber.

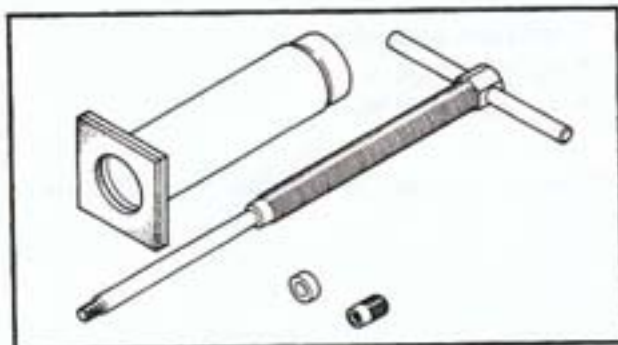

**FOR ENGINE SERVICE**

1. Piston pin puller  
P/N. YU-01304  
P/N. 90890-01304

This tool is used to remove the piston pin.

## SPECIAL TOOLS

GEN  
INFO

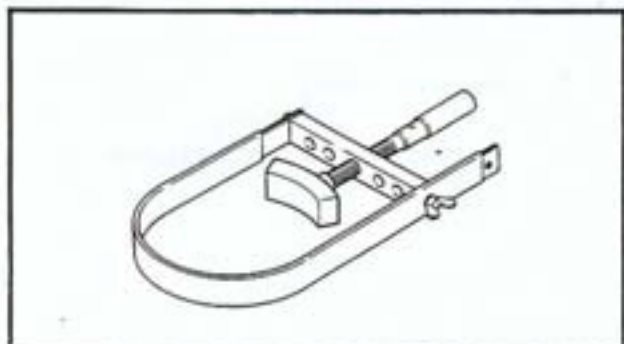

2. Rotor holder  
P/N. YS-01880  
P/N. 90890-01701

This tool is used to hold the rotor when removing or installing the rotor securing nut.

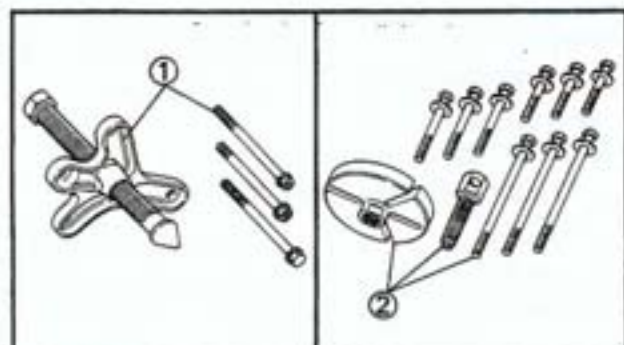

3. Rotor puller  
P/N. YU-33270-①  
P/N. 90890-01362-②

This tool is used to remove the rotor.

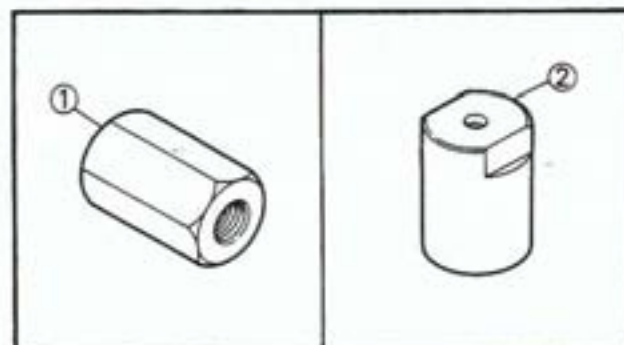

4. Rotor puller adapter  
P/N. YM-04063-A-①  
P/N. 90890-04063-②

This tool is used to remove the rotor.

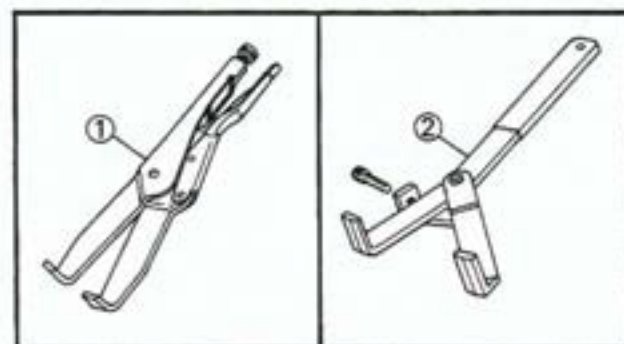

5. Universal clutch holder  
P/N. YM-91042-①  
P/N. 90890-04086-②

This tool is used to hold the clutch when removing or installing the clutch boss locknut.

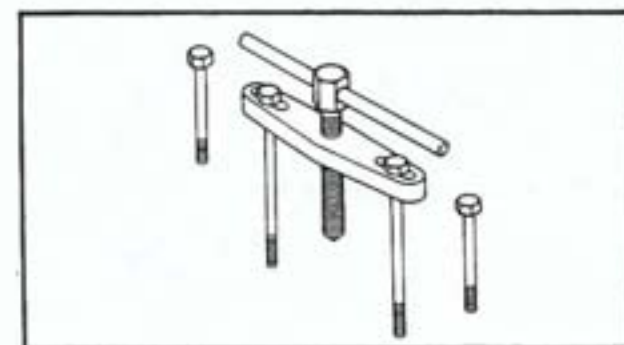

6. Crankcase separator  
P/N. YU-01135-A  
P/N. 90890-01135

This tool is necessary to separate the crankcase.

## SPECIAL TOOLS

GEN  
INFO

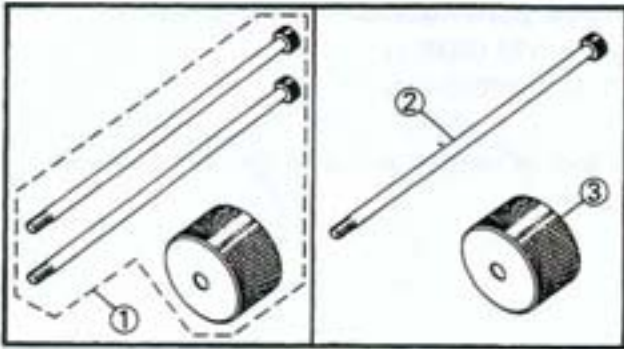

7. Slide hammer set  
P/N. YU-01083-A—①  
Slide hammer bolt  
P/N. 90890-01083—②  
Weight  
P/N. 90890-01084—③

These tools are used when removing the rocker arm shaft.

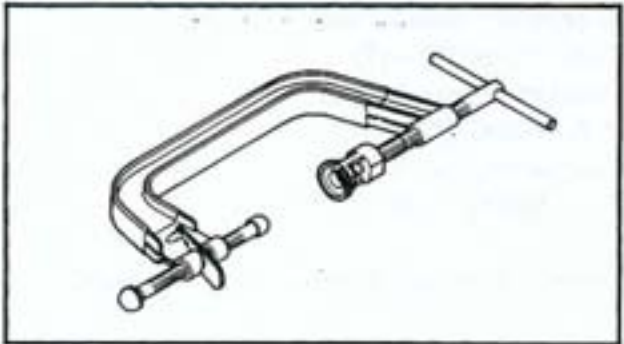

8. Valve spring compressor  
P/N. YM-04019  
P/N. 90890-04019

This tool is needed to remove and install the valve assemblies.

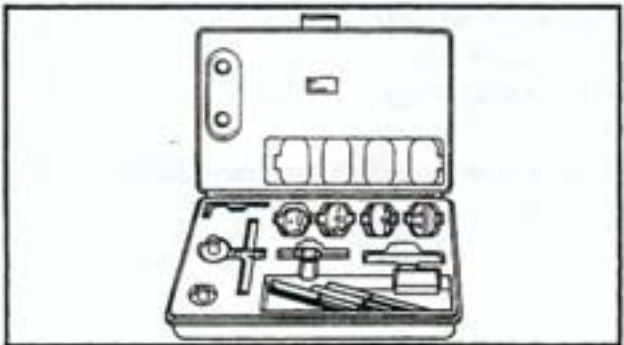

9. Valve seat cutter set  
P/N. YM-91043

This tool is needed to resurface the valve seat.



10. Valve guide remover 6 mm (0.24 in)  
P/N. YM-04064  
P/N. 90890-04064

This tool is used to remove the valve guides.



11. Valve guide reamer 6 mm (0.24 in)  
P/N. YM-04066  
P/N. 90890-04066

This tool is used to rebore the new valve guide.



## SPECIAL TOOLS

GEN  
INFO

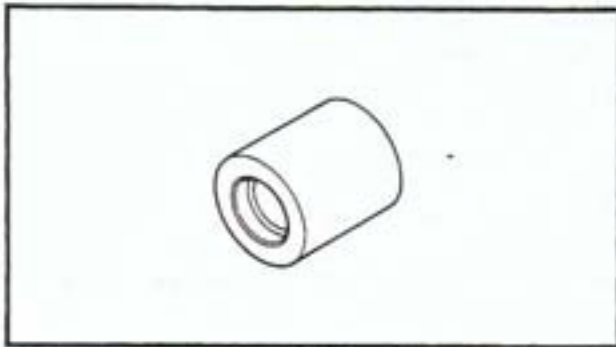

12. Valve guide installer 6 mm (0.24 in)  
P/N. YM-04065-A  
P/N. 90890-04065

This tool is needed to install the valve guides properly.

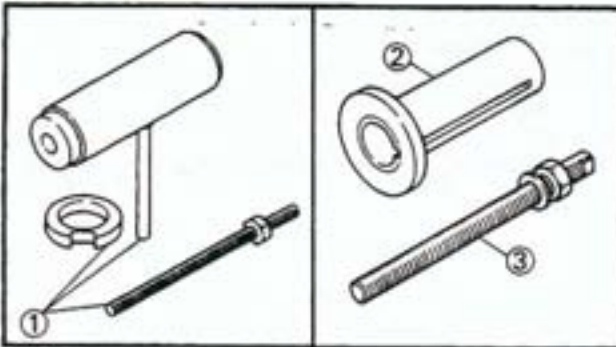

13. Crankshaft installer set  
P/N. YU-90050—①  
Crankshaft installer pot  
P/N. 90890-01274—②  
Crankshaft installer bolt  
P/N. 90890-01275—③

These tools are used to install the crankshaft.

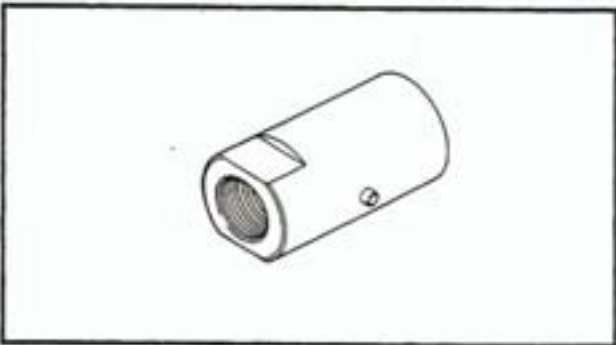

14. Adapter #10 (M14)  
P/N. YM-90069  
P/M. 90890-04059

This tool is used to install the crankshaft.

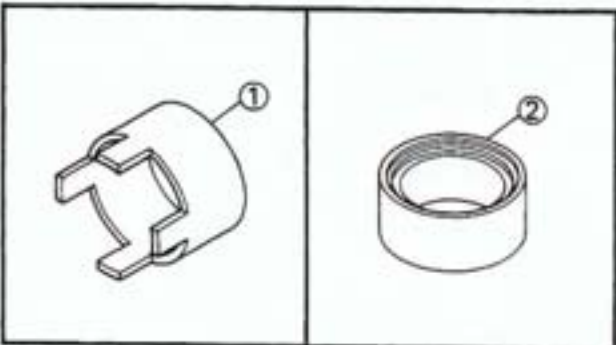

15. Crank pot spacer  
P/N. YM-91044  
P/N. 90890-04081—①  
Spacer  
P/N. 90890-01288—②

This tool is used to install the crankshaft.

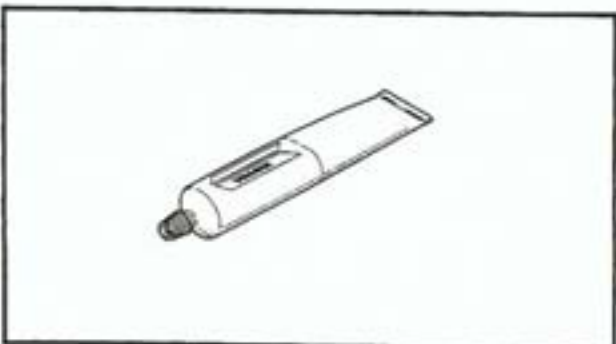

16. Sealant (quick gasket)<sup>®</sup>  
P/N. ACC-11001-01  
Yamaha Bond No. 1215<sup>®</sup>  
P/N. 90890-85505

This sealant (bond) is used for crankcase mating surfaces, etc.



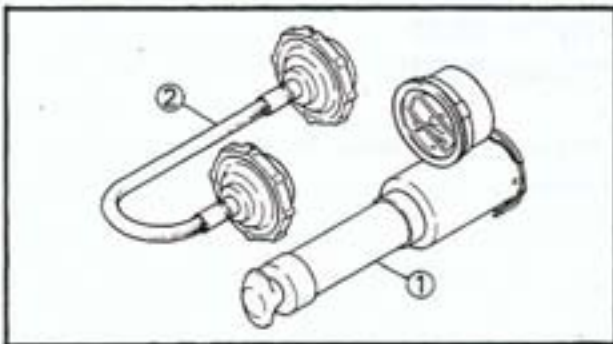

17. Radiator cap tester  
 P/N. YU-24460-01  
 P/N. 90890-01325—①  
 Adapter  
 P/N. YU-33984  
 P/N. 90890-01352—②

This tester is used for checking the cooling system.

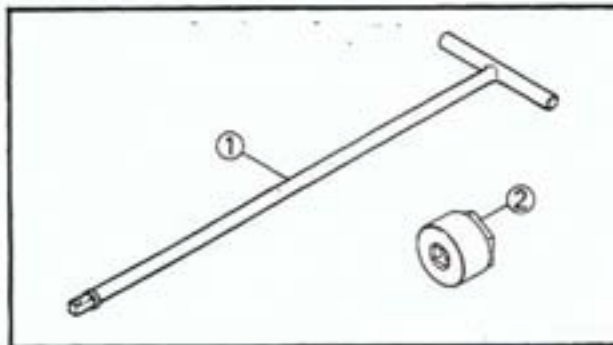

**FOR CHASSIS SERVICE**

1. T-Handle  
 P/N. YM-01326  
 P/N. 90890-01326—①  
 Damper rod holder 30 mm (1.18 in)  
 P/N. YM-01327  
 P/N. 90890-01327—②

This tool is used to loosen and tighten the front fork damper rod holding bolt.

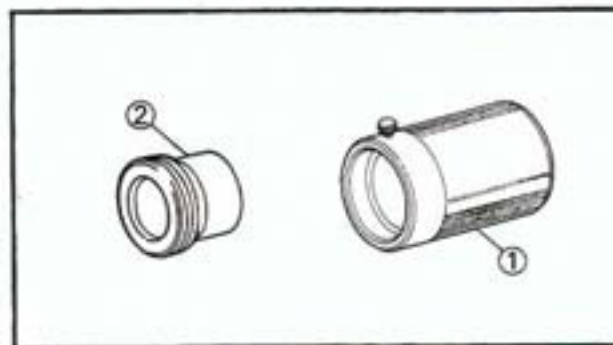

2. Front fork seal drive weight  
 P/N. YM-33963  
 P/N. 90890-01367—①  
 Adapter 43 mm (1.69 in)  
 P/N. YM-08020  
 P/N. 90890-01374—②

These tools are used when installing the fork oil seal.

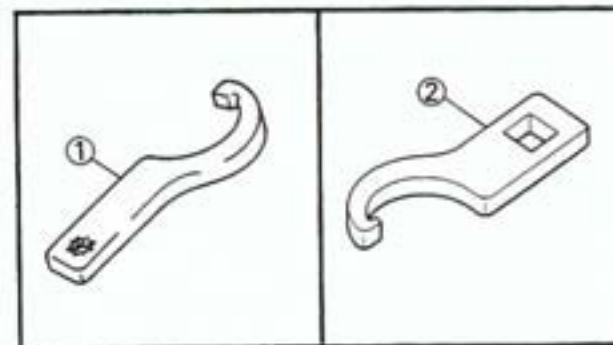

3. Ring nut wrench  
 P/N. YU-33975—①  
 P/N. 90890-01403—②

This tool is used to loosen and tighten the steering ring nut.

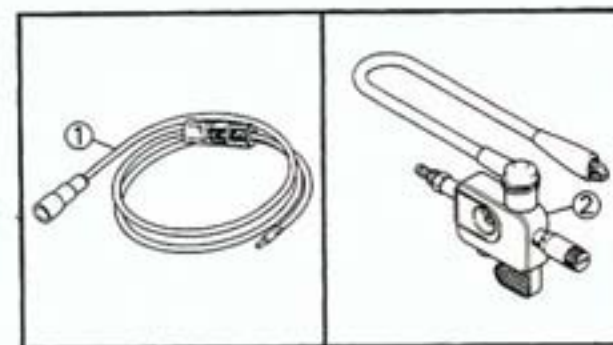

**FOR ELECTRICAL COMPONENTS**

1. Dynamic spark tester  
 P/N. YM-34487—①  
 Ignition checker  
 P/N. 90890-06754—②

This instrument is necessary for checking the ignition system components.

## SPECIAL TOOLS

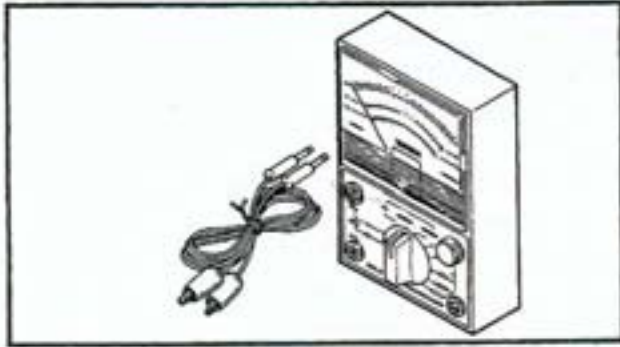

- 2. Pocket tester  
P/N. YU-03112  
P/N. 90890-03112

This instrument is available for checking the electrical system.

## CHAPTER 2. SPECIFICATIONS

<b>GENERAL SPECIFICATIONS .....</b>	<b>A-16</b>
<b>MAINTENANCE SPECIFICATIONS .....</b>	<b>B-1</b>
ENGINE .....	B-1
CHASSIS.....	B-6
ELECTRICAL.....	B-8
<b>GENERAL TORQUE SPECIFICATIONS .....</b>	<b>B-10</b>
<b>DEFINITION OF UNITS .....</b>	<b>B-10</b>
<b>LUBRICATION POINT AND LUBRICANT TYPE .....</b>	<b>B-10</b>
ENGINE .....	B-10
CHASSIS.....	B-11
<b>LUBRICATION DIAGRAM .....</b>	<b>B-11</b>
<b>COOLANT DIAGRAM.....</b>	<b>B-13</b>
<b>CABLE ROUTING.....</b>	<b>B-14</b>



SPECIFICATIONS

GENERAL SPECIFICATIONS

Model	XTZ660
Model Code Number:	3YF1: (A)(B)(D)(DK)(F)(GB)(GR)(I)(N)(NL) (PRT)(S)(SF) 3YF2: (CNR)(E) 4BW1: (A)(CH)
Vehicle Identification Number:	JYA3YFS0*MA029101: (CNR)(E)
Frame Starting Number:	3YF-000101: (A)(B)(D)(DK)(F)(GB)(GR)(I)(N)(NL) (PRT)(S)(SF) 4BW-000101: (A)(CH)
Engine Starting Number:	3YF-000101: (A)(B)(D)(DK)(F)(GB)(GR)(I)(N)(NL) (PRT)(S)(SF) 3YF-029101: (CNR)(E) 4BW-000101: (A)(CH)
Dimensions:	
Overall Length	2,265 mm (89.2 in) 2,355 mm (92.7 in): (CH)(D)(DK)(N)(S)(SF)
Overall Width	885 mm (34.8 in)
Overall Height	1,355 mm (53.3 in)
Seat Height	865 mm (34.1 in)
Wheelbase	1,495 mm (58.9 in)
Minimum Ground Clearance	245 mm (9.6 in)
Basic Weight:	
With Oil and Full Fuel Tank	195 kg (430 lb)
Minimum Turning Radius:	2,400 mm (94.5 in)
Engine:	
Engine Type	Liquid cooled 4-stroke, SOHC
Cylinder Arrangement	Forward inclined single cylinder
Displacement	660 cm <sup>3</sup>
Bore × Stroke	100 × 84 mm (3.94 × 3.31 in)
Compression Ratio	9.2 : 1
Compression Pressure	1,100 kPa (11,0 kg/cm <sup>2</sup> , 156 psi)
Starting System	Electric starter
Lubrication System:	Dry sump
Engine Oil Type or Grade:	<p>SAE 20W40 type SE motor oil</p> <p>SAE 10W30 type SE motor oil</p>



# GENERAL SPECIFICATIONS

**SPEC**

Model	XTZ660	
<b>Engine Oil Capacity:</b> Periodic Oil Change: With Oil Filter Replacement Total Amount	2.6 L (2.3 Imp qt, 2.7 US qt) 2.7 L (2.4 Imp qt, 2.9 US qt) 3.0 L (2.6 Imp qt, 3.2 US qt)	
<b>Coolant Total Amount:</b> (Including All Routes)	1.2 L (1.1 Imp qt, 1.3 US qt)	
<b>Air Filter:</b>	Dry type element	
<b>Fuel:</b> Type  Tank Capacity Reserve Amount	Regular unleaded gasoline with a research octane number of 91 or higher 20 L (17.6 Imp qt, 21.1 US gal) 3.5 L (3.1 Imp qt, 3.7 US gal)	
<b>Carburetor:</b> Type × Quantity Manufacturer	Y26PV × 1 TEIKEI	
<b>Spark Plu:</b> Type Manufacturer Gap	DPR8EA-9/DPR9EA-9 NGK 0.8 ~ 0.9 mm (0.031 ~ 0.035 in)	
<b>Clutch Type:</b>	Wet, multiple-disc	
<b>Transmission:</b> Transmission Type Operation Primary Reduction System Primary Reduction Ratio Secondary Reduction System Secondary Reduction Ratio Gear Ratio      1st 2nd 3rd 4th 5th	Constant mesh 5-speed Left foot operation Spur gear 71/34 (2.088) Chain Drive 45/15 (3.000) 31/12 (2.583) 27/17 (1.588) 24/20 (1.200) 21/22 (0.954) 19/24 (0.792)	
<b>Chassis:</b> Frame Type Caster Angle Trail	Diamond 28.0° 112 mm (4.41 in)	
<b>Tire:</b>  Type Size Manufacture (Type)	Front	Rear
	With tube 90/90-21 54S BRIDGESTONE (TW41) DUNLOP (TRAIL MAX G)	With tube 120/90-17 64S BRIDGESTONE (TW42B) DUNLOP (TRAIL MAX G)

# GENERAL SPECIFICATIONS

**SPEC**



Model	XTZ660	
Tire Pressure (Cold Tire): Maximum load*	180 kg (397 lb)	
Cold tire pressure	Front	Rear
Up to 90 kg (198 lb) load*	200 kPa (2.00 kg/cm <sup>2</sup> , 28 psi)	200 kPa (2.00 kg/cm <sup>2</sup> , 28 psi)
90 kg (198 lb) – Maximum load*	200 kPa (2.00 kg/cm <sup>2</sup> , 28 psi)	225 kPa (2.25 kg/cm <sup>2</sup> , 32 psi)
*Load is total weight of cargo, rider, passenger, and accessories.		
<b>Brake:</b> Front Brake Type Operation Rear Brake Type Operation	Single disc brake Right hand operation Single disc brake Right foot operation	
<b>Suspension:</b> Front Suspension Rear Suspension	Telescopic fork Swingarm (Link suspension)	
<b>Shock absorber:</b> Front Shock Absorber Rear Shock Absorber	Coil-Air spring/Oil damper Coil-Gas spring/Oil damper	
<b>Wheel Travel:</b> Front Wheel Travel Rear Wheel Travel	220 mm (8.66 in) 200 mm (7.87 in)	
<b>Electrical:</b> Ignition System Generator System Battery Type or Model Battery Capacity	T.C.I. (Digital) A.C. magneto generator YTX9-BS 12V, 8AH	
<b>Headlight Type:</b>	Quartz bulb (Halogen)	
<b>Bulb Wattage × Quantity:</b> Headlight Auxiliary Light  Tail/Brake Light Flasher Light	12V 60W/55W × 1 12V 4W × 1 12V 3.4W × 1 (GB) 12V 5W/21W × 1 12V 21W × 4	
<b>Indicator Light:</b> Wattage × Quantity	"METER LIGHT" "NEUTRAL" "HIGH BEAM" "TURN"	12V 1.7W × 2 12V 3.4W × 1 12V 3.4W × 1 12V 3.4W × 2

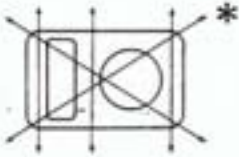
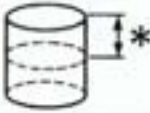
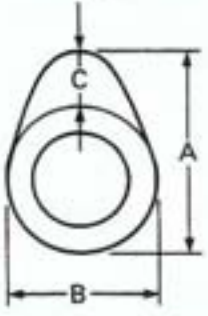
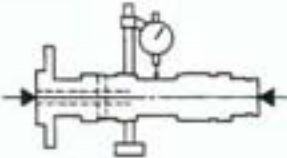

**MAINTENANCE SPECIFICATIONS**  
**ENGINE**

Model	XTZ660
<p>Cylinder Head: Warp Limit*</p> 	<p>0.03 mm (0.0012 in) * Lines indicate straightedge measurement.</p>
<p>Cylinder: Bore Size/Measuring Point*</p>  <p>&lt;Wear limit&gt;</p>	<p>100.005 ~ 100.045 mm (3.9372 ~ 3.9388 in) 50 mm (1.97 in)  100.1 mm (3.941 in)</p>
<p>Camshaft: Drive Method Camshaft Outside Diameter Shaft-to-cap Clearance Cam Dimensions: Intake</p>  <p>Exhaust</p> <p>Camshaft Runout Limit</p> 	<p>Chain drive (Left) 22.967 ~ 22.980 mm (0.9042 ~ 0.9047 in) 0.020 ~ 0.054 mm (0.0008 ~ 0.0021 in) 35.69 ~ 35.79 mm (1.4051 ~ 1.4091 in) 35.54 mm (1.3992 in) 30.06 ~ 30.16 mm (1.1835 ~ 1.1874 in) 29.91 mm (1.1776 in) 5.74 mm (0.2260 in) 36.50 ~ 36.60 mm (1.4370 ~ 1.4409 in) 36.35 mm (1.4311 in) 30.11 ~ 30.21 mm (1.1854 ~ 1.1894 in) 29.96 mm (1.1795 in) 6.55 mm (0.2579 in) 0.03 mm (0.0012 in)</p>
<p>Timing Chain: Chain Type/No. of Links Chain Adjustment Method</p>	<p>75 RH 2015/126 Links Automatic</p>
<p>Rocker Arm/Rocker Arm Shaft: Rocker Arm Inside Diameter Shaft Outside Diameter Arm-to-shaft Clearance</p>	<p>12.000 ~ 12.018 mm (0.472 ~ 0.473 in) 11.976 ~ 11.991 mm (0.471 ~ 0.472 in) 0.009 ~ 0.042 mm (0.0004 ~ 0.0020 in)</p>





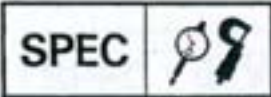

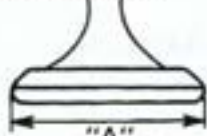
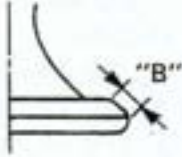
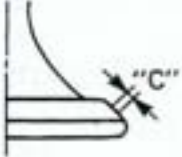
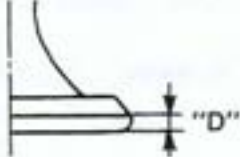
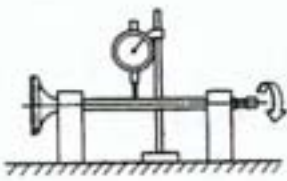

# MAINTENANCE SPECIFICATIONS

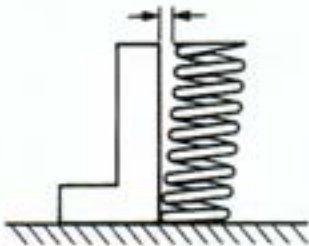

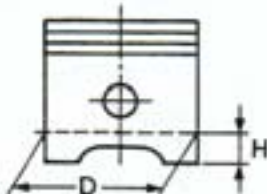
Model	XTZ660	
Valve, Valve Seat, Valve Guide: Valve Clearance (Cold):		
IN.	0.10 ~ 0.15 mm (0.004 ~ 0.006 in)	
EX.	0.15 ~ 0.20 mm (0.006 ~ 0.008 in)	
Valve Dimensions:		
 "A" Head Dia.	 Face Width	 Seat Width
		 Margin Thickness
"A" Head Dia.	IN.	29.9 ~ 30.1 mm (1.1772 ~ 1.1850 in)
	EX.	31.9 ~ 32.1 mm (1.2560 ~ 1.2638 in)
"B" Face Width	IN.	2.25 mm (0.0886 in)
	EX.	2.26 mm (0.0890 in)
"C" Seat Width	IN.	0.9 ~ 1.1 mm (0.035 ~ 0.043 in)
	EX.	0.9 ~ 1.1 mm (0.035 ~ 0.043 in)
"D" Margin Thickness Limit	IN.	0.85 ~ 1.15 mm (0.0335 ~ 0.0453 in)
	EX.	0.85 ~ 1.15 mm (0.0335 ~ 0.0453 in)
Stem Outside Diameter	IN.	5.975 ~ 5.990 mm (0.2352 ~ 0.2358 in)
	EX.	5.960 ~ 5.975 mm (0.2346 ~ 0.2352 in)
< Limit >	IN.	5.95 mm (0.234 in)
	EX.	5.93 mm (0.233 in)
Guide Inside Diameter	IN.	6.000 ~ 6.012 mm (0.2362 ~ 0.2367 in)
	EX.	6.000 ~ 6.012 mm (0.2362 ~ 0.2367 in)
< Limit >	IN.	6.05 mm (0.238 in)
	EX.	6.55 mm (0.258 in)
Stem-to-Guide Clearance	IN.	0.010 ~ 0.037 mm (0.0004 ~ 0.0015 in)
	EX.	0.025 ~ 0.052 mm (0.0010 ~ 0.0020 in)
< Limit >	IN.	0.08 mm (0.003 in)
	EX.	0.1 mm (0.004 in)
Stem Runout Limit		0.01 mm (0.0004 in)
		
Valve Seat Width	IN.	0.9 ~ 1.1 mm (0.035 ~ 0.043 in)
	EX.	0.9 ~ 1.1 mm (0.035 ~ 0.043 in)

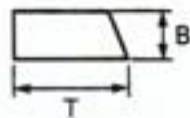

Model	XTZ660	
<p><b>Valve Spring:</b></p> <p>Free Length</p> <p>Set Length (Valve Closed)</p> <p>Compressed Pressure (Valve Closed)</p> <p>Tilt Limit</p>  <p>Direction of Winding (Top View)</p>	<p>IN. 32.63 mm (1.285 in)</p> <p>EX. 36.46 mm (1.435 in)</p> <p>IN. 27.50 mm (1.083 in)</p> <p>EX. 31.00 mm (1.220 in)</p> <p>IN. 10.2 ~ 11.8 kg (22.49 ~ 26.01 lb)</p> <p>EX. 12.3 ~ 14.1 kg (27.12 ~ 31.08 lb)</p> <p>IN. 2.5°/1.4 mm (2.5°/0.055 in)</p> <p>EX. 2.5°/1.6 mm (2.5°/0.063 in)</p> <p>IN. Clockwise </p> <p>EX. Clockwise </p>	
<p><b>Piston:</b></p> <p>Piston Size "D"</p> <p>Measuring Point "H"</p>  <p>Piston Off-set</p> <p>Piston Off-set Direction</p> <p>Piston-to-Cylinder Clearance &lt;Limit&gt;</p>	<p>99.945 ~ 99.985 mm (3.935 ~ 3.936 in)</p> <p>2.5 mm (0.098 in)</p> <p>1 mm (0.04 in)</p> <p>INSIDE</p> <p>0.050 ~ 0.070 mm (0.0020 ~ 0.0028 in)</p> <p>&lt; 0.15 mm (0.0059 in) &gt;</p>	
<p><b>Piston Ring:</b></p> <p><b>Top Ring:</b></p> <p>Type</p> <p>Dimensions (B × T)</p> <p>End Gap (Installed)</p> <p>Side Clearance (Installed)</p>  <p><b>2nd Ring:</b></p> <p>Type</p> <p>Dimensions (B × T)</p> <p>End Gap (Installed)</p> <p>Side Clearance</p>  <p><b>Oil Ring:</b></p> <p>Dimensions (B × T)</p> <p>End Gap (Installed)</p> <p>Side Clearance</p> 	<p>Barrel</p> <p>1.2 × 3.8 mm (0.047 × 0.150 in)</p> <p>0.30 ~ 0.45 mm (0.012 ~ 0.018 in)</p> <p>0.04 ~ 0.08 mm (0.002 ~ 0.003 in)</p> <p>Taper</p> <p>1.2 × 4.0 mm (0.047 × 0.157 in)</p> <p>0.30 ~ 0.45 mm (0.012 ~ 0.018 in)</p> <p>0.03 ~ 0.07 mm (0.001 ~ 0.003 in)</p> <p>2.5 × 3.4 mm (0.098 × 0.134 in)</p> <p>0.2 ~ 0.7 mm (0.008 ~ 0.028 in)</p> <p>0.015 ~ 0.042 mm (0.0006 ~ 0.0017 in)</p>	



Model	XTZ660
<b>Crankshaft:</b> Crank Width "A" Runout Limit "C" Big End Side Clearance "D" Big End Radial Clearance "E" Small End Free Play "F"	74.95 ~ 75.00 mm (2.951 ~ 2.953 in) 0.03 mm (0.0012 in) 0.35 ~ 0.65 mm (0.014 ~ 0.026 in) 0.01 ~ 0.025 mm (0.0004 ~ 0.0010 in) 0.8 ~ 1.0 mm (0.0315 ~ 0.0394 in)
<b>Balancer:</b> Drive Method	Spur gear
<b>Clutch:</b> <b>Friction Plate:</b> Thickness Quantity Wear Limit <b>Friction plate:</b> Thickness Quantity Wear limit <b>Clutch Plate:</b> Thickness Quantity Warp Limit <b>Clutch Spring:</b> Free Length Quantity Minimum Free Length Clutch Release Method	2.74 ~ 2.86 mm (0.108 ~ 0.113 in) 6 pcs. 2.6 mm (0.102 in) 2.94 ~ 3.06 mm (0.116 ~ 0.120 in) 2 pcs. 2.8 mm (0.110 in) 1.2 mm (0.047 in) 7 pcs. 0.2 mm (0.008 in) 42.8 mm (1.685 in) 5 pcs. 40.8 mm (1.606 in) Outer pull, rack and pinion pull
<b>Transmission:</b> Main Axle Runout Limit Drive Axle Runout Limit	0.08 mm (0.003 in) 0.08 mm (0.003 in)
<b>Shifter:</b> Type	Cam Drum and Guide bar
<b>Decompression Device:</b> Type	Auto



# MAINTENANCE SPECIFICATIONS

**SPEC**



Model	XTZ660	
Carburetor: I.D. Mark	3YF 00, 4BW 00 (A)(CH)	
	Primary	Secondary
Main Jet (M.J.)	# 130	# 165
Main Air Jet (M.A.J.)	φ1.0	φ1.0
Jet Needle (J.N.)	5D96-3/5 5D97-3/5 (A)(CH)	5X7C-3/5
Needle Jet (N.J.)	V00	φ2.7
Pilot Jet (P.J.)	# 48	—
Pilot Air Jet (P.A.J.)	φ0.6	—
Bypass (B.P.)	φ1.0	—
Pilot Screw (P.S.)	2 and 1/2 turns out	—
Valve Seat (V.S.)	φ2.5	—
Starter Jet (G.S.)	# 76	
Pilot Outlet (P.O.)	φ0.8	
Fuel Level (F.L.)	6.0 ~ 8.0 mm (0.24 ~ 0.31 in) Below from the float chamber mating surface	
Float Height (F.H.)	25 ~ 27 mm (0.98 ~ 1.06 in)	
Engine Idling Speed	1,250 ~ 1,350 r/min	
Vacuum Pressure at Idling Speed	26.6 ~ 34.6 kPa (200 ~ 260 mmHg, 7.87 ~ 10.24 in Hg)	
Lubrication System:		
Oil Filter Type	Paper type	
Oil Pump Type	Trochoid pump type	
Tip Clearance	0.12 mm (0.005 in)	
Side Clearance	0.03 ~ 0.08 mm (0.001 ~ 0.003 in)	
Bypass Valve Setting Pressure	80 ~ 120 kPa (0.8 ~ 1.2 kg/cm <sup>2</sup> , 11.38 ~ 17.07 psi)	
Cooling System:		
Radiator Core Size	Width	280 mm (11.02 in)
	Height	147.8 mm (5.82 in)
	Thickness	32 mm (1.26 in)
Radiator Cap Opening Pressure	95 ~ 125 kPa (0.95 ~ 1.25 kg/cm <sup>2</sup> , 13.51 ~ 17.77 psi)	
Recovery Tank Capacity < From Low to Full Level >	0.29 L (0.26 Imp qt, 0.31 US qt) < 0.17 L (0.15 Imp qt, 0.18 US qt) >	
Water Pump		
Type	Single-suction centrifugal pump	
Reduction Ratio	33/34 (0.971)	
Thermostat		
Opening Temperature	80 ~ 84°C (176 ~ 183°F)	

# MAINTENANCE SPECIFICATIONS

**SPEC**



## TIGHTENING TORQUE

Part to be tightened	Part name	Thread size	Q'ty	Tightening torque			Remarks
				Nm	m•kg	ft•lb	
Cylinder head	Flange bolt	M9	4	38	3.8	27	 Use lock washer
Cylinder head	Flange bolt	M9	2	38	3.8	27	
Cylinder head	Hexagon socket head bolt	M6	1	10	1.0	7.2	
Cylinder head (Exhaust pipe)	Stud bolt	M6	4	7	0.7	5.1	
Cylinder head	Straight plug screw	M18		55	5.5	40	
Spark plug	—	M12	1	17.5	1.75	13	
Cylinder head cover	Hexagon socket head bolt	M6	16	10	1.0	7.2	
Cylinder head cover	Hexagon socket head bolt	M6	1	10	1.0	7.2	
Cylinder head side cover	Hexagon socket head bolt	M6	4	10	1.0	7.2	
Gear unit assembly	Hexagon socket head bolt	M6	1	10	1.0	7.2	
Tachometer cable stopper	Flat head screw	M6	1	7	0.7	5.1	
Cylinder	Flange bolt	M10	2	42	4.2	30	
Cylinder	Flange bolt	M10	2	42	4.2	30	
Cylinder	Hexagon socket head bolt	M6	2	10	1.0	7.2	
Holder 1	Hexagon socket head bolt	M6	1	10	1.0	7.2	
Balance weight gear	Nut	M16	1	60	6.0	43	
AC generator rotor	Nut	M14	1	150	15.0	110	
Valve clearance	Nut	M6	4	14	1.4	10	
Stopper guide 2	Hexagon head bolt	M6	2	8	0.8	5.8	
Cam sprocket	Flange bolt	M7	2	20	2.0	14	
Tensioner assembly	Hexagon socket head bolt	M6	2	10	1.0	7.2	
Rocker shaft stopper	Hexagon socket head bolt	M6	2	10	1.0	7.2	
Water pump	Hexagon socket head bolt	M6	3	10	1.0	7.2	
Joint 1	Hexagon socket head bolt	M6	2	10	1.0	7.2	
Pipe 1	Hexagon socket head bolt	M6	1	10	1.0	7.2	
Conduction	Flange bolt	M6	2	10	1.0	7.2	
Conduction	Flange bolt	M6	1	10	1.0	7.2	
Protector	Panhead screw	M5	2	5	0.5	3.6	
Radiator	Flange bolt	M6	3	10	1.0	7.2	
Oil pump assembly	Flange bolt	M6	3	10	1.0	7.2	
Cover 2	Panhead screw	M6	1	7	0.7	5.1	

# MAINTENANCE SPECIFICATIONS

**SPEC**





Part to be tightened	Part name	Thread size	Q'ty	Tightening torque			Remarks
				Nm	m•kg	ft•lb	
Strainer housing	Panhead screw	M6	2	7	0.7	5.1	
Drain plug	Straight screw plug	M14	1	30	3.0	22	
Element cover	Hexagon socket head bolt	M6	1	10	1.0	7.2	
Element cover	Hexagon socket head bolt	M6	2	10	1.0	7.2	
Element cover air bleed screw	Screw	M5	1	5	0.5	3.6	
Oil hose 1	Hexagon socket head bolt	M6	4	10	1.0	7.2	
Oil hose 2	Hexagon socket head bolt	M6	2	10	1.0	7.2	
Delivery pipe	Union bolt	M10	2	20	2.0	14	
Delivery pipe	Hexagon head bolt	M6	1	10	1.0	7.2	
Carburetor joint	Hexagon socket head bolt	M6	4	10	1.0	7.2	
Carburetor joint (carburetor left)	Hose clamp	M4	1	2	0.2	1.4	
Carburetor joint (carburetor right)	Hose clamp	M5	1	5	0.5	3.6	
Carburetor joint (air filter left)	Hose clamp	M4	1	2	0.2	1.4	
Carburetor joint (air filter right)	Hose clamp	M5	1	5	0.5	3.6	
Air filter assembly	Flange bolt	M6	4	10	1.0	7.2	
Air filter assembly	Flange bolt	M6	3	10	1.0	7.2	
Exhaust pipe	Nut	M6	4	10	1.0	7.2	
Exhaust pipe 1 & Exhaust pipe 2	Hexagon socket head bolt	M8	1	20	2.0	14	
Exhaust pipe protector	Bind head screw	M6	2	7	0.7	5.1	
Muffler protector (rubber)	Bind head screw	M6	2	7	0.7	5.1	
Muffler protector (cylinder)	Bind head screw	M6	4	7	0.7	5.1	
Exhaust pipe & Muffler	Flange bolt	M8	1	20	2.0	14	
Muffler mounting (front, lower)	Hexagon socket head bolt	M8	1	40	4.0	29	
Muffler mounting (upper)	Hexagon socket head bolt	M8	1	40	4.0	29	
Muffler mounting (lower)	Hexagon socket head bolt	M8	1	40	4.0	29	
Case 1 & 2	Hexagon socket head bolt	M6	9	10	1.0	7.2	
Case 1 & 2	Hexagon socket head bolt	M6	4	10	1.0	7.2	
Case 1 & 2	Hexagon socket head bolt	M6	1	10	1.0	7.2	
Clamp (lead)	Panhead screw	M6	1	7	0.7	5.1	



# MAINTENANCE SPECIFICATIONS



**SPEC**

Part to be tightened	Part name	Thread size	Q'ty	Tightening torque			Remarks
				Nm	m•kg	ft•lb	
Crankcase cover 1	Hexagon socket head bolt	M6	6	10	1.0	7.2	
Crankcase cover 1	Hexagon socket head bolt	M6	1	10	1.0	7.2	
Crankcase cover 1	Hexagon socket head bolt	M6	1	10	1.0	7.2	
Crankcase cover 1	Hexagon socket head bolt	M6	1	10	1.0	7.2	
Crankcase cover 1	Straight plug screw	M8	1	10	1.0	7.2	
Crankcase cover 2	Hexagon socket head bolt	M6	2	10	1.0	7.2	
Crankcase cover 3	Hexagon socket head bolt	M6	5	10	1.0	7.2	
Crankcase cover 3	Hexagon socket head bolt	M6	3	10	1.0	7.2	
Crankcase cover 3	Hexagon socket head bolt	M6	2	10	1.0	7.2	
Bearing plate cover	Flat head screw	M6	3	7	0.7	5.1	
Lock plate	Hexagon head bolt	M6	2	10	1.0	7.2	
Clutch spring	Screw with washer	M6	5	8	0.8	5.8	
Clutch boss	Nut	M20	1	90	9.0	65	Use lock washer
Primary drive gear	Nut	M20	1	120	12.0	85	Use lock washer
Push lever assembly (stopper)	Bolt	M6	1	6.5	0.65	4.7	
Push lever assembly	Screw	M8	1	12	1.2	8.7	
Drive sprocket	Nut	M18	1	110	11.0	80	Use lock washer
Oilseal cover	Hexagon head bolt	M6	2	10	1.0	7.2	
Stopper lever	Screw with washer	M6	1	10	1.0	7.2	
Shift arm	Bolt	M6	1	10	1.0	7.2	
Stator coil	Panhead screw with washer	M6	3	7	0.7	5.1	
Neutral switch	—	M10	1	20	2.0	14	
Cylinder head side cover 1	—	M32	2	12	1.2	8.7	
Spring tensioner	Plug	M16	1	20	2.0	14	
Starting motor	Flange bolt	M6	2	10	1.0	7.2	
Cover 1	Hexagon socket head bolt	M6	1	10	1.0	7.2	

# MAINTENANCE SPECIFICATIONS

**SPEC**



Part to be tightened	Part name	Thread size	Q'ty	Tightening torque			Remarks
				Nm	m•kg	ft•lb	
Cover 1	Hexagon socket head bolt	M6	3	10	1.0	7.2	
Starter oneway clutch	Hexagon socket head bolt	M8	3	30	3.0	22	Stake 
Pick up	Panhead screw	M5	2	5	0.5	3.6	
Ignition coil	Hexagon head bolt	M5	2	5	0.5	3.6	
Ignition coil bracket	Flange bolt	M6	2	10	1.0	7.2	
Ignition unit	Panhead screw	M6	2	5	0.5	3.6	
Thermo switch	Panhead screw	M16	1	28	2.8	20	
Thermo unit	Panhead screw	PT 1/8	1	15	1.5	11	



Model

XTZ660

### Lubrication Chart:

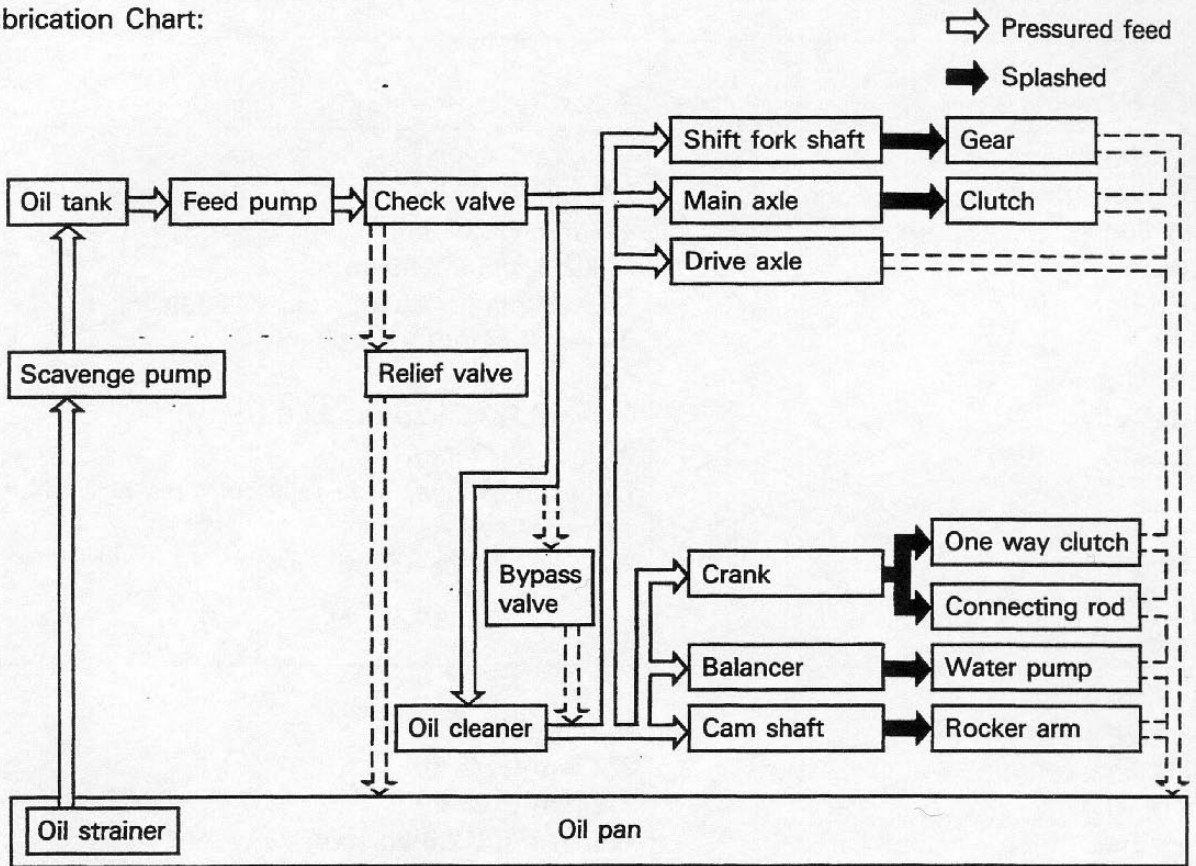

### Crankcase Tightening Sequence:

Crankcase (Left)

Crankcase (Right)

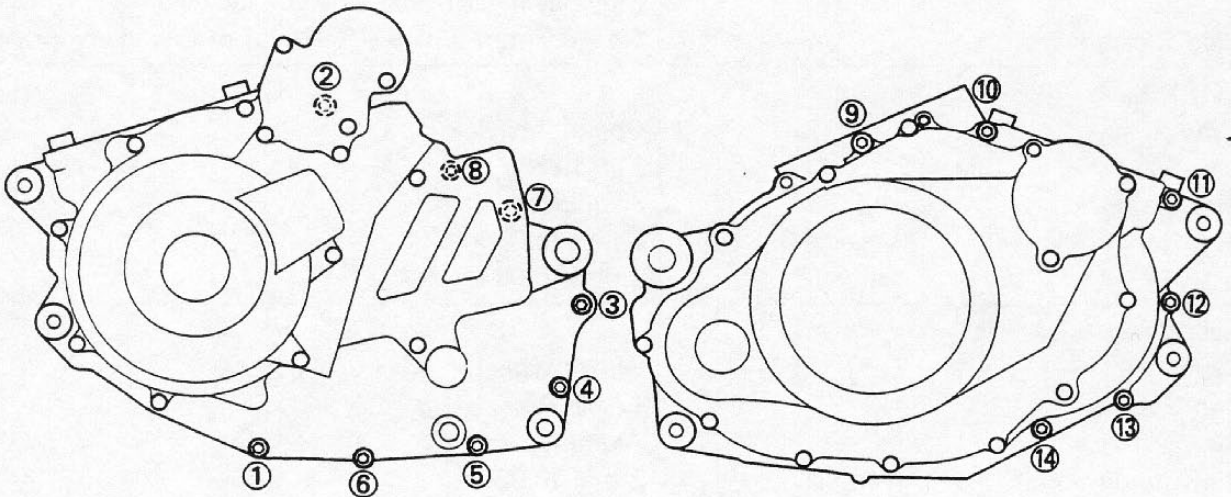



# MAINTENANCE SPECIFICATIONS

**SPEC**



## CHASSIS

Model	XTZ660
<b>Steering System:</b> Steering Bearing Type	Taper Roller Bearing
<b>Front Suspension:</b> Front Fork Travel Front Spring Free Length < Limit > Spring Rate:                   K1 Stroke                            K1 Optional Spring Oil Capacity Oil Level  Oil Grade Enclosed Air Pressure: Standard	220 mm (8.66 in) 407 mm (16.02 in) < 402.9 mm (15.86 in) > 4.25 N/mm (0.425 kg/mm, 23.80 lb/in) 0.0 ~ 220 mm (0.0 ~ 8.66 in) No 669 cm <sup>3</sup> (23.5 Imp oz, 22.6 US oz) 94 mm (3.70 in) From top of inner tube fully compressed without spring. Fork oil 10W or equivalent  Zero
<b>Rear Suspension:</b> Shock Absorber Travel Spring Free Length Fitting Length Spring Rate                    K1 Stroke                            K1 Optional Spring Enclosed Gas Pressure: Standard	66 mm (2.60 in) 222 mm (8.74 in) 212 mm (8.35 in) 125 N/mm (12.5 kg/mm, 700 lb/in) 0.0 ~ 83.0 mm (0.0 ~ 3.3 in) No  1.500 kPa (15 kg/cm <sup>2</sup> , 213 psi)
<b>Swingarm:</b> Free Play Limit  Side Clearance	1.0 mm (0.039 in) at swingarm end Move swingarm end side to side 0.4 ~ 0.7 mm (0.016 ~ 0.028 in) at swingarm pivot
<b>Front Wheel:</b> Type Rim Size Rim Material Rim Runout Limit            Vertical Lateral	Spoke wheel 21 × 1.85 Aluminum 2 mm (0.08 in) 2 mm (0.08 in)
<b>Rear Wheel:</b> Type Rim Size Rim Material Rim Runout Limit            Vertical Lateral	Spoke wheel 17 × 2.75 Aluminum 2 mm (0.08 in) 2 mm (0.08 in)
<b>Drive Chain:</b> Type/Manufacturer No. of Links Chain Free Play	520V6/DAIDO, 520SM0Z9/RK 110 20 ~ 45 mm (0.79 ~ 1.77 in)

# MAINTENANCE SPECIFICATIONS

**SPEC**



Model	XTZ660
<p><b>Front Disc Brake:</b></p> <p>Type</p> <p>Disc Outside Diameter × Thickness</p> <p>Pad Thickness                      Inner</p> <p style="padding-left: 150px;">&lt; Limit &gt; *</p> <p>Pad Thickness                      Outer</p> <p style="padding-left: 150px;">&lt; Limit &gt; *</p> <div style="text-align: center;"> </div> <p>Master Cylinder Inside Diameter</p> <p>Caliper Cylinder Inside Diameter</p> <p>Brake Fluid Type</p>	<p>Dual</p> <p>282 × 5 mm (11.1 × 0.20 in)</p> <p>5.0 mm (0.20 in)</p> <p>&lt; 1.0 mm (0.04 in) &gt;</p> <p>5.0 mm (0.20 in)</p> <p>&lt; 1.0 mm (0.04 in) &gt;</p> <p>14 mm (0.55 in)</p> <p>32.03 mm (1.26 in)</p> <p>DOT #4</p>
<p><b>Rear Disc Brake:</b></p> <p>Type</p> <p>Disc Outside Diameter × Thickness</p> <p>Pad Thickness                      Inner</p> <p style="padding-left: 150px;">&lt; Limit &gt; *</p> <p>Pad Thickness                      Outer</p> <p style="padding-left: 150px;">&lt; Limit &gt; *</p> <div style="text-align: center;"> </div> <p>Master Cylinder Inside Diameter</p> <p>Caliper Cylinder Inside Diameter</p> <p>Brake Fluid Type</p>	<p>Single</p> <p>220 × 5 mm (8.66 × 0.20 in)</p> <p>6.0 mm (0.24 in)</p> <p>&lt; 0.8 mm (0.03 in) &gt;</p> <p>6.0 mm (0.24 in)</p> <p>&lt; 0.8 mm (0.03 in) &gt;</p> <p>12.7 mm (0.50 in)</p> <p>34.9 mm (1.37 in)</p> <p>DOT #4</p>
<p><b>Brake Lever and Brake Pedal:</b></p> <p>Brake Lever Free Play</p> <p>Brake Pedal Position</p>	<p>2 ~ 5 mm (0.08 ~ 0.20 in)</p> <p>At brake lever end.</p> <p>25 mm (0.98 in)</p> <p>Below top of footrest.</p>
<p><b>Clutch Lever and Throttle Grip:</b></p> <p>Clutch Lever Free Play</p> <p>Throttle Grip Free Play</p>	<p>10 ~ 15 mm (0.39 ~ 0.59 in)</p> <p>At clutch lever end.</p> <p>3 ~ 5 mm (0.12 ~ 0.20 in)</p> <p>At grip flange.</p>

# MAINTENANCE SPECIFICATIONS

**SPEC**





## TIGHTENING TORQUE

Part to be tightened	Thread size	Tightening torque			Remarks
		Nm	m•kg	ft•lb	
<b>Front fork/Handlebar:</b>					
Handle crown and inner tube	M 8×1.25	23	2.3	17	
Handle crown and steering shaft	M14×1.25	110	11	80	
Handlebar holder (under) and handlebar holder (upper)	M 8×1.25	23	2.3	17	
Steering shaft and ring nut	M25×1.0	7	0.7	5.1	See note
Front brake hose and clamp	M 6×1.0	7	0.7	5.1	
Front master cylinder cap	M 4×0.7	2	0.2	1.4	
Front master cylinder and handlebar	M 6×1.0	7	0.7	5.1	
Cowling stay and cowling	M 6×1.0	7	0.7	5.1	
Horn and frame	M 6×1.0	7	0.7	5.1	
Main switch and handle crown	M 6×1.0	7	0.7	5.1	
Handlebar holder (under) and nut	M10×1.25	30	3.0	22	
Band (meter cables)	M 5×0.8	0.7	0.07	0.5	
Console panel and protector 1, 2	M 5×0.8	0.7	0.07	0.5	
Headlight and cowling stay	M 6×1.0	7	0.7	5.1	
Under bracket and inner tube	M 8×1.25	23	2.3	17	
Cowling stay and frame	M 8×1.25	15	1.5	11	
Cowling and fuel tank	M 6×1.0	7	0.7	5.1	
Protector 1, 2 and cowling	M 5×0.8	0.7	0.07	0.5	
<b>Engine mount:</b>					
Front engine stay and frame	M10×1.25	65	6.5	47	
Top engine stay and frame	M10×1.25	65	6.5	47	
Engine (rear under) and frame	M10×1.25	65	6.5	47	
Engine protector and frame	M 6×1.0	9	0.9	6.5	
<b>Swingarm/Rear shock absorber:</b>					
Pivot shaft and frame	M14×1.5	100	10.0	72	
Swingarm and relay arm	M12×1.25	80	8.0	58	
Relay arm and connecting rod	M10×1.25	48	4.8	35	
Connecting rod and frame	M10×1.25	48	4.8	35	
Rear shock absorber and frame	M12×1.25	58	5.8	42	
Chain tensioner securing bolt	M 8×1.25	23	2.3	17	
Chain case and swingarm	M 6×1.0	4	0.4	2.9	
Guard seal and swingarm	M 6×1.0	7	0.7	5.1	
Chain support and swingarm	M 6×1.0	7	0.7	5.1	
<b>Fuel tank/Seat/Rear fender/Side cover:</b>					
License bracket and number plate stay	M 6×1.0	7	0.7	5.1	
Rear reflector and stay	M 5×0.8	4	0.4	2.9	
Fuel tank and fuel cock	M 6×1.0	7	0.7	5.1	
License bracket and flap	M 4×0.7	3	0.3	22	
Helmet holder and carrier	M 6×1.0	7	0.7	5.1	
Fuel tank back stay and frame	M 6×1.0	7	0.7	5.1	
Clutch cable and engine	M 6×1.0	9	0.9	6.5	
Starter relay and lead	M 6×1.0	3	0.3	22	



# MAINTENANCE SPECIFICATIONS

**SPEC**

Part to be tightened	Thread size	Tightening torque			Remarks
		Nm	m•kg	ft•lb	
License bracket and taillight	M 6×1.0	7	0.7	5.1	
Regulator and frame	M 6×1.0	7	0.7	5.1	
Fuel tank upper bracket and frame	M 8×1.25	15	1.5	11	
Fuel tank lower bracket and frame	M 8×1.25	15	1.5	11	
Fuel pump and frame	M 6×1.0	7	0.7	5.1	
Carrier and frame (front and rear)	M 8×1.25	15	1.5	11	
Fuel tank bracket and fuel tank	M 6×1.0	7	0.7	5.1	
Tool box and frame	M 8×1.0	7	0.7	5.1	
License bracket and frame	M 6×1.0	7	0.7	5.1	
Bracket 1 and frame	M 6×1.0	23	2.3	17	
Front wheel/Rear wheel:					
Front wheel and brake disc	M 8×1.25	20	2.0	14	
Front wheel axle and front fork	M14×1.5	58	5.8	42	
Rear wheel axle and nut	M16×1.5	100	10.0	72	
Front axle holder	M 6×1.0	9	0.9	6.5	
Front brake caliper and front fork	M10×1.25	35	3.5	25	
Union bolt	M10×1.25	26	2.6	19	
Front brake caliper and bleed screw	M 8×1.25	6	0.6	4.3	
Rear brake caliper and bleed screw	M 7×1.0	6	0.6	4.3	
Rear wheel and sprocket	M10×1.25	60	6.0	4.3	
Rear wheel and brake disc	M 6×1.0	10	1.0	7.2	
Footrest/Pedal:					
Sidestand securing bolt and nut	M12×1.25	45	4.5	32	
Sidestand securing bolt and frame	M12×1.25	45	4.5	32	
Rear brake switch and frame	M 6×1.0	4	0.4	2.9	
Footrest and frame	M10×1.25	50	5.0	36	
Rear footrest and frame	M 8×1.25	23	2.3	17	
Rear master cylinder and frame	M 8×1.25	23	2.3	17	
Rear brake reservoir tank and frame	M 6×1.0	4	0.4	2.9	
Rear brake pedal shaft and frame	M10×1.25	35	3.5	25	

**NOTE:**

1. First, tighten the ring nut (lower) approximately 43 Nm (4.3 m•kg, 31 ft•lb) by using the torque wrench. Turn the handlebar to the left and right making sure there is no binding and then fully loosen the ring nut.
2. Retighten the ring nut (lower) to specification.
3. Install the rubber washer on the ring nut (lower); then finger tighten the ring nut (upper) until it contacts the rubber washer. Align the grooves of the lower and upper nuts and install the stopper washer.

**ELECTRICAL**

Model	XTZ660
Voltage Ignition System: Ignition Timing (B.T.D.C.) Advanced Timing (B.T.D.C.) Advancer Type	12V  12° at 1,300 r/min 38° at 6,500 r/min Electrical type
<p style="text-align: center;">Ignition Timing (B.T.D.C.)</p> <p style="text-align: center;">Engine Speed (<math>\times 10^3</math> r/min)</p>	
Ignitor: Pickup Coil Resistance (Color) Ignitor Unit/Manufacturer	184 ~ 276 $\Omega$ at 20°C (68°F) (Blue/Yellow – Green/White) TNDF13/NIPPONDENSO
Ignition Coil: Model/Manufacturer Minimum Spark Gap Primary Winding Resistance Secondary Winding Resistance Spark Plug Cap: Type Resistance	JO268/NIPPONDENSO 6 mm (0.24 in) 3.4 ~ 4.6 $\Omega$ at 20°C (68°F) 10.4 ~ 15.6 k $\Omega$ at 20°C (68°F)  Resin type 10 k $\Omega$ at 20°C (68°F)
Charging System: Type	A.C. magneto generator

# MAINTENANCE SPECIFICATIONS

**SPEC**



Model	XTZ660
<b>A.C. Generator:</b> Model/Manufacturer Nominal Output	TLMZ55/NIPPONDENSO 14V 24.5A at 5,000 r/min
<p style="text-align: center;">Output Current</p> <p style="text-align: center;">Engine Speed (<math>\times 10^3</math> r/min)</p>	
Stator Coil Resistance (Color)	0.20 ~ 0.30 $\Omega$ at 20°C (68°F) (White—White)
<b>Rectifier/Regulator:</b> Model/Manufacturer Type Voltage Regulator No load Regulated Voltage Rectifier Capacity Withstand Voltage	SH569/SINDENGEN Semi conductor—Short circuit type  14.3 ~ 15.3V  25A 240V
<b>Battery:</b> Specific Gravity	1.320
<b>Electrical Starter System:</b> Type Starter Motor: Model/Manufacturer Output Brush—Overall Length < Limit > Commutator Dia. Wear Limit Mica Undercut Starter Relay: Model/Manufacturer Amperage Rating	Constant mesh type  SM-13/MITSUBA 0.8 kW 12.5 mm (0.49 in) < 5 mm (0.20 in) > 28.0 mm (1.10 in) 27.0 mm (1.06 in) 0.7 mm (0.028 in)  MS5D-191/HITACHI 100A
<b>Horn:</b> Type/Quantity Model/Manufacturer Maximum Amperage	Plane type/1 pc. YF-12/NIKKO 2.5A



# MAINTENANCE SPECIFICATIONS

**SPEC**



Model	XTZ660
<b>Flasher Relay (Relay Assembly):</b> Type Model/Manufacturer Self Cancelling Device Flasher Frequency Wattage	Condenser type FB257M/NIPPONDENSO, G8A-101/OMRON No 60 ~ 120 cyl/min 21W × 4 + 3.4W
<b>Starting Circuit Cut-Off Relay:</b> Model/Manufacturer Coil Winding Resistance Diode	G8MS/OMRON 90 ~ 110 Ω Yes
<b>Electric Fan:</b> Model/Manufacturer	NAAF48/NIPPONDENSO
<b>Thermostat Switch:</b> Model/Manufacturer Function Temperature	VF105A/N. THERMOSTAT 102 ~ 108°C (215.6 ~ 226.4°F): ON 98°C (208.4°F): OFF
<b>Thermo Unit:</b> Model/Manufacturer Coil Winding Resistance	11H/NIPPON SEIKI 153.9 Ω at 50°C (122°F) 47.5 ~ 52.8 Ω at 80°C (176°F) 26.2 ~ 29.3 Ω at 100°C (212°F) 16.1 Ω at 120°C (248°F)
<b>Circuit Breaker:</b> Type Amperage for Individual Circuit × Quantity: MAIN RESERVE	Fuse 20A/1 pc. 20A/1 pc.



## GENERAL TORQUE SPECIFICATIONS

This chart specifies torque for standard fasteners with standard I.S.O. pitch threads. Torque specifications for special components or assemblies are included in the applicable sections of this book. To avoid warpage, tighten multi-fastener assemblies in a crisscross fashion, in progressive stages, until full torque is reached. Unless otherwise specified, torque specifications call for clean, dry threads. Components should be at room temperature.

A (Nut)	B (Bolt)	General torque specifications		
		Nm	m•kg	ft•lb
10 mm	6 mm	6	0.6	4.3
12 mm	8 mm	15	1.5	11
14 mm	10 mm	30	3.0	22
17 mm	12 mm	55	5.5	40
19 mm	14 mm	85	8.5	61
22 mm	16 mm	130	13.0	94

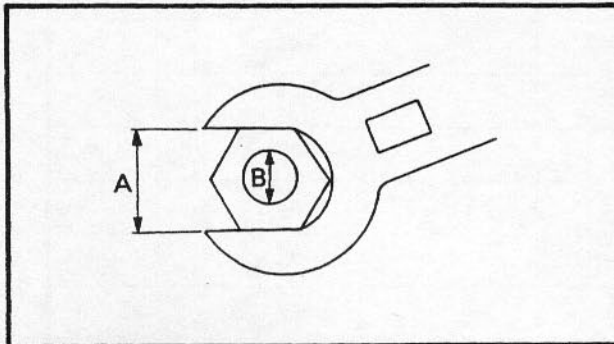

A: Distance across flats  
B: Outside thread diameter

## DEFINITION OF UNITS

Unit	Read	Definition	Measure
mm	millimeter	$10^{-3}$ meter	Length
cm	centimeter	$10^{-2}$ meter	Length
kg	kilogram	$10^3$ gram	Weight
N	Newton	$1 \text{ kg} \times \text{m}/\text{sec}^2$	Force
Nm	Newton meter	$\text{N} \times \text{m}$	Torque
m•kg	Meter kilogram	$\text{m} \times \text{kg}$	Torque
Pa	Pascal	$\text{N}/\text{m}^2$	Pressure
N/mm	Newton per millimeter	N/mm	Spring rate
L	Liter	—	Volume or capacity
cm <sup>3</sup>	Cubic centimeter	—	Volume or capacity
r/min	Revolution per minute	—	Engine speed

# LUBRICATION POINTS AND LUBRICANT TYPE

SPEC



## LUBRICATION POINTS AND LUBRICANT TYPE ENGINE

Lubrication points (part name)	Lubricant type
Oil seal lips (all)	
Bearing retainer	
Crank pin	
Connecting rod (big end)	
Piston and piston ring	
Boss (balancer drive gear)	
Piston pin	
Valve stem and valve guide	
Oil seal (valve stem end)	
Rocker arm shaft and rocker arm	
Cam and bearing (camshaft)	
Decomp cam and decomp shaft	
Rotor and rotor housing (oil pump)	
Push rod	
Primary driven gear and main axle	
Sliding gear (transmission)	
Free movement gear (transmission)	
Driven gear and drive gear (tachometer gear unit)	
Shift fork and guide bar	
Shift cam and bearing (shift cam)	
Shift shaft	
Crankcase mating surfaces	Sealant (quick gasket) <sup>®</sup> Yamaha Bond No. 1215
Mating surfaces (cylinder head and cylinder head cover)	Sealant (quick gasket) <sup>®</sup> Yamaha Bond No. 1215



# LUBRICATION POINTS AND LUBRICANT TYPE

SPEC



## CHASSIS

Lubrication points (part name)	Lubricant type
Gear unit (speedometer)	
Oil seal lips (all)	
Wheel axle (front wheel and rear wheel)	
Rear wheel hub and clutch hub	
Bush (swingarm) and thrust cover	
Pivot shaft (swingarm)-	
Bushes (rear shock absorber)	
Bushes (relay arm and connecting rod)	
Bearings (relay arm and connecting rod)	
Pivoting points (brake pedal and change pedal)	
Bearings (steering head)	
Right handlebar end	
Pivoting points (brake lever and clutch lever)	
Clutch cable end	
Pivoting point (sidestand)	
Bushes (chain tensioner)	
Grease nipple (swingarm)	
Grease nipple (relay arm)	
Grease nipple (connecting rod)	



## LUBRICATION DIAGRAM

- ① Oil tank
- ② Oil pump
- ③ Oil strainer (engine)

- A Feed
- B Scavenge

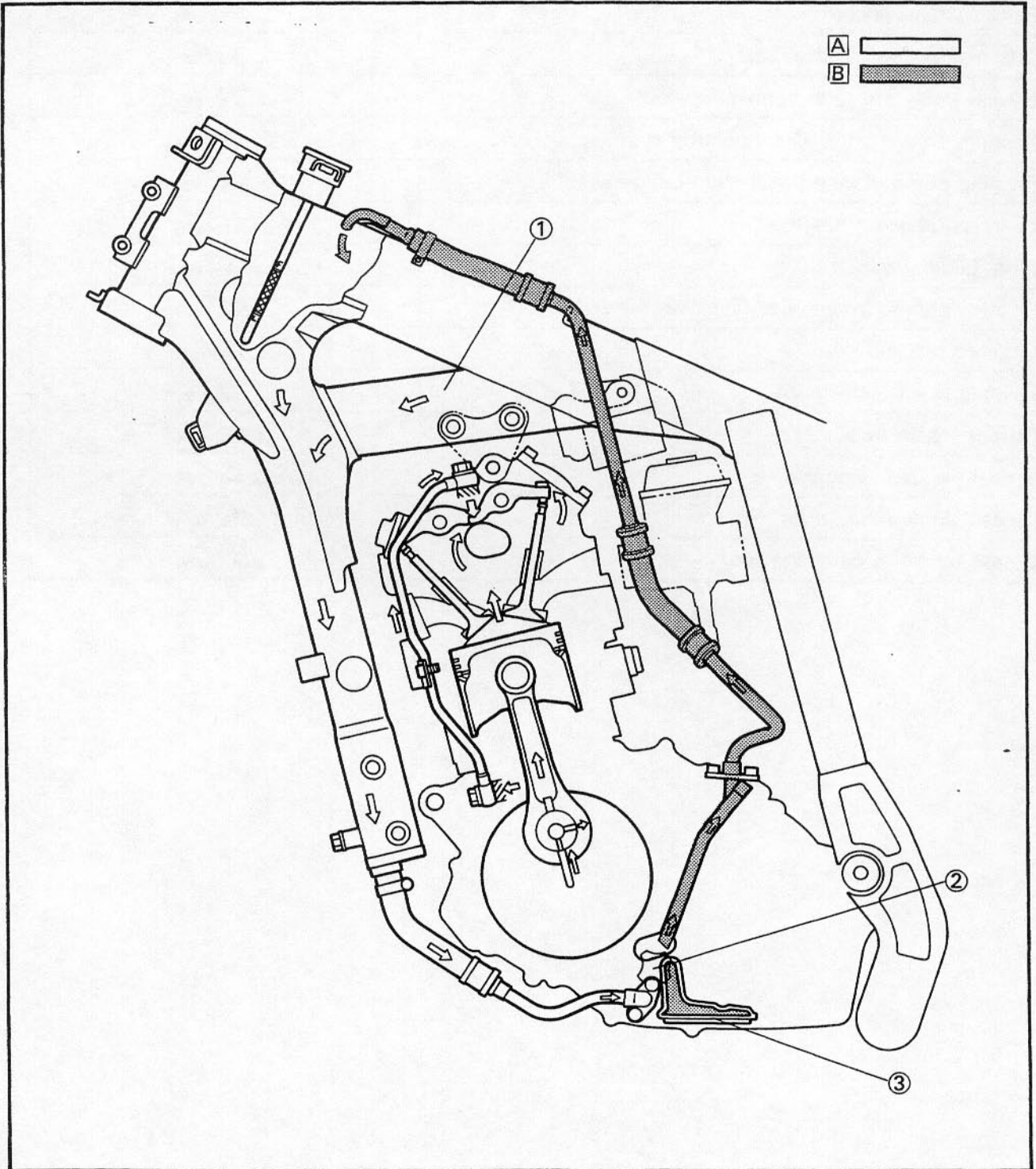

# LUBRICATION DIAGRAM

SPEC



- ① Cam shaft
- ② Oil delivery pipe
- ③ Oil filter
- ④ Oil pump
- ⑤ Main axle
- ⑥ Drive axle
- ⑦ Oil hose
- ⑧ Oil delivery pipe

- A Feed
- B Scavenge

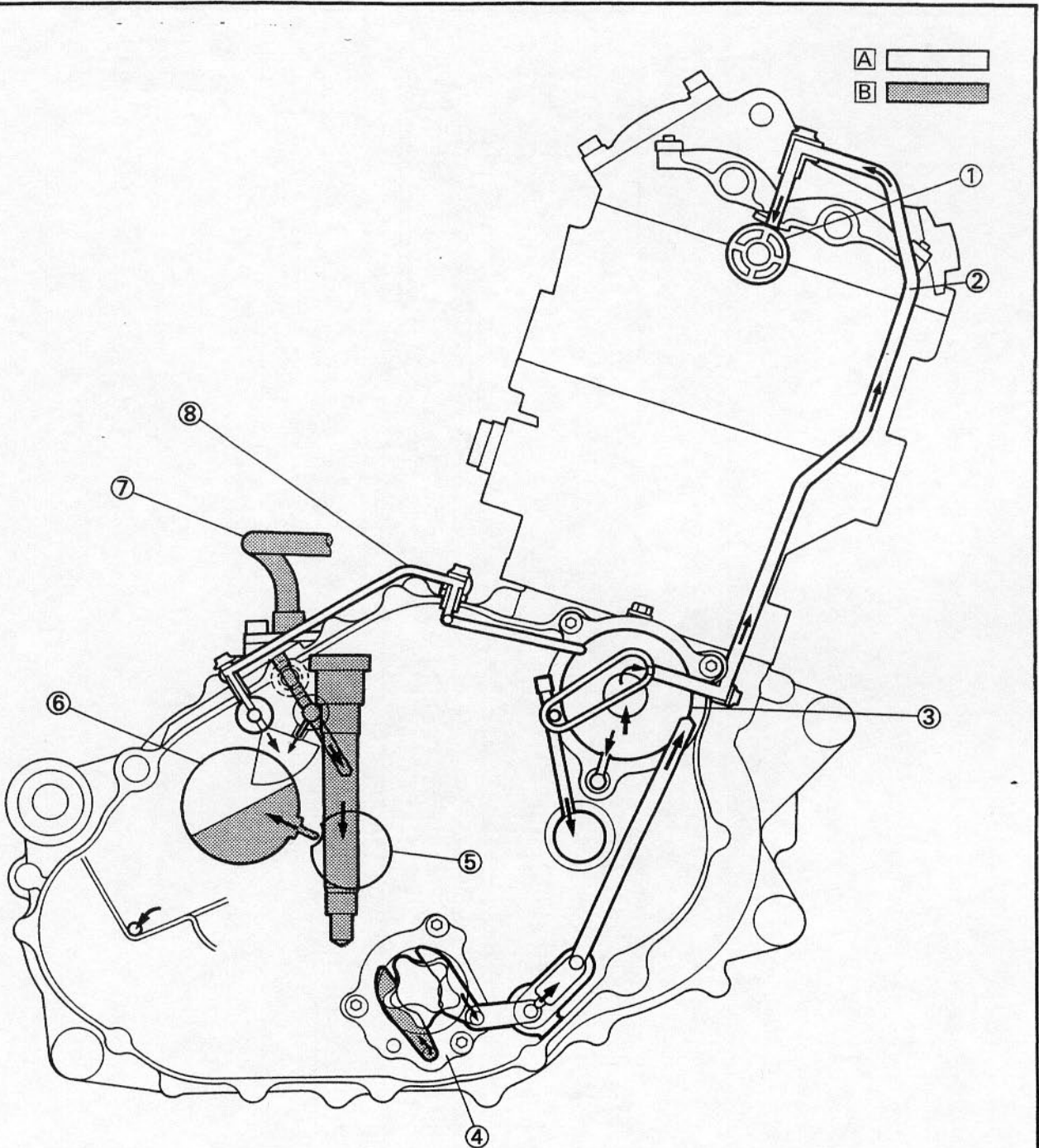



# LUBRICATION DIAGRAM

SPEC



- ① Cam shaft
- ② Oil delivery pipe
- ③ Oil filter
- ④ Crank pin
- ⑤ Main axle
- ⑥ Drive axle
- ⑦ Drain bolt

- A Feed
- B Scavenge

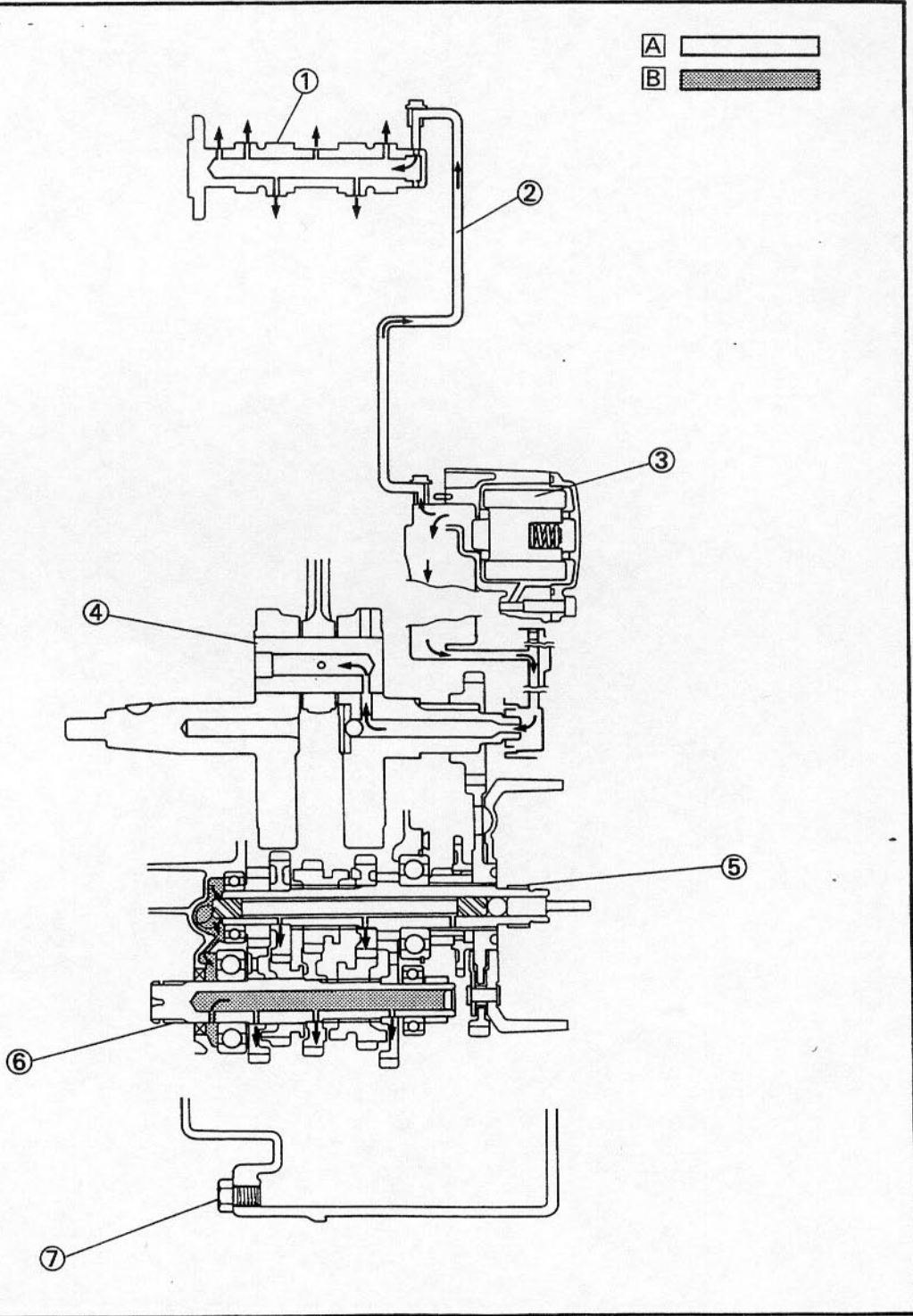

# LUBRICATION DIAGRAM

SPEC



- ① Oil delivery pipe
- ② Oil filter
- ③ Oil pump
- ④ Transmission
- ⑤ Oil strainer

- ▢ A Feed
- ▢ B Scavenge

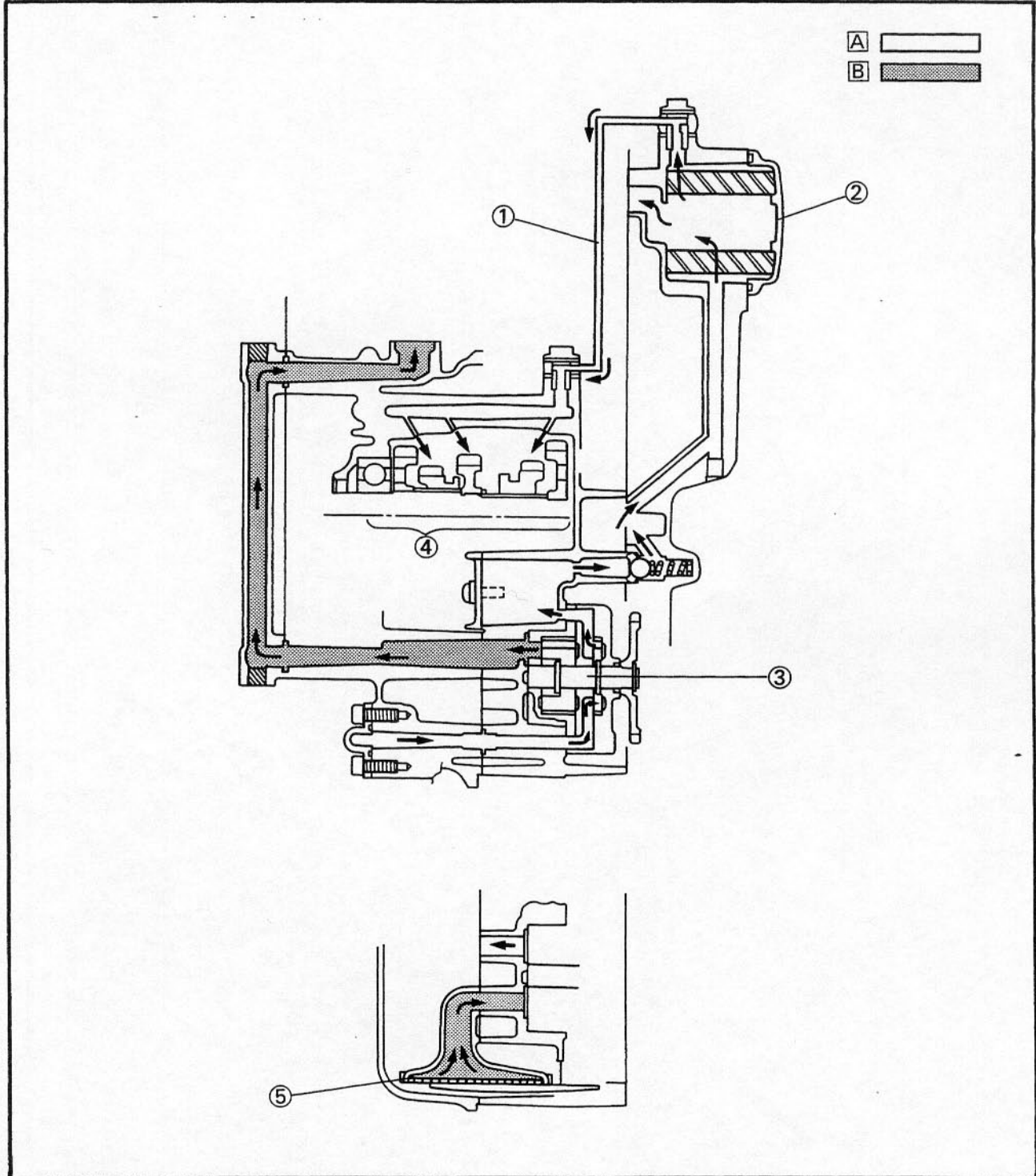



## COOLANT DIAGRAM

- ① Radiator cap
- ② Thermostat
- ③ Thermostat housing
- ④ Radiator
- ⑤ Water pump

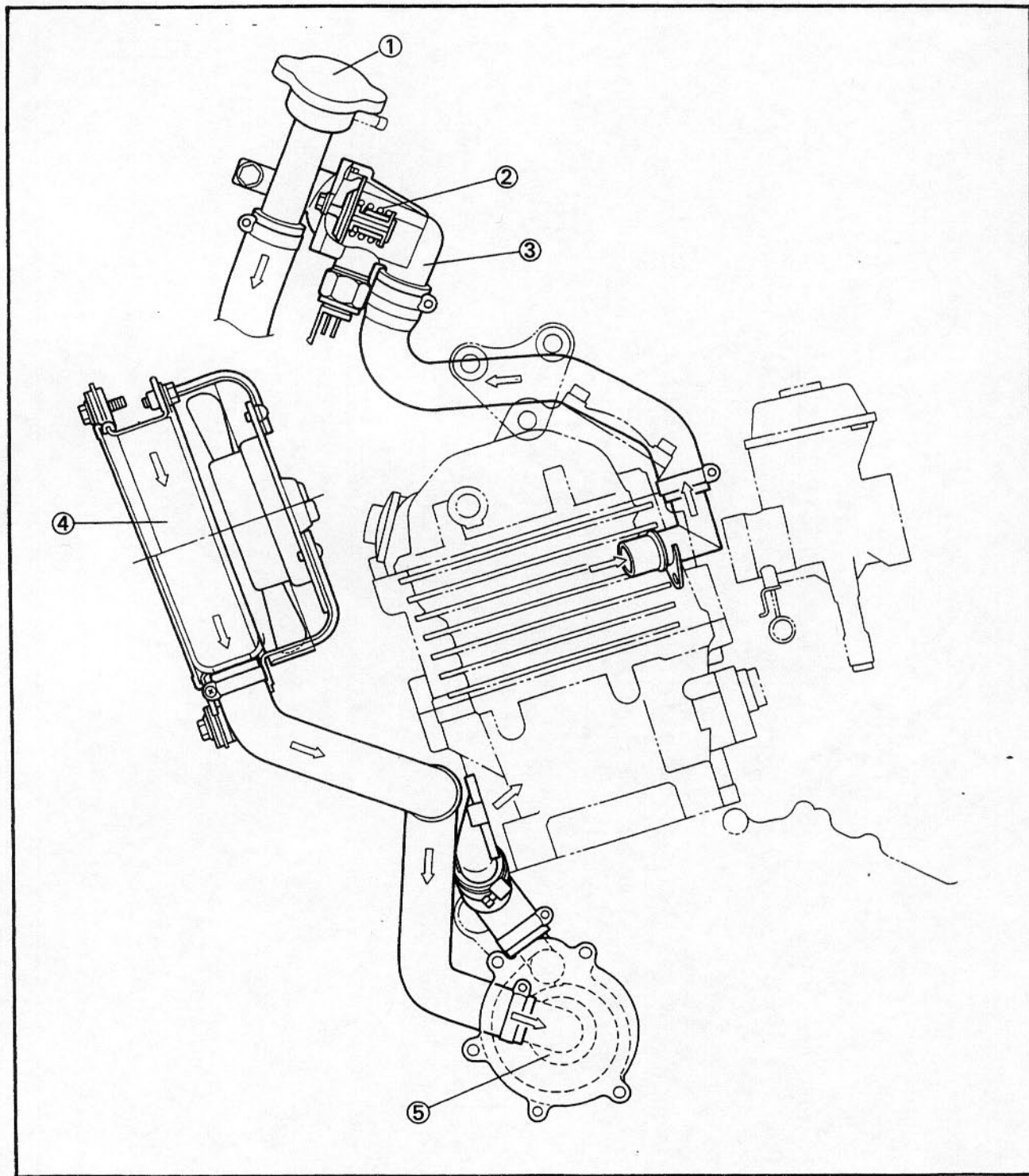





## CABLE ROUTING

- ① Clutch cable
- ② Cable guide
- ③ Brake hose
- ④ Front brake switch lead
- ⑤ Throttle cable
- ⑥ Handlebar switch lead
- ⑦ Band
- ⑧ Clutch switch lead
- ⑨ Handlebar switch lead
- ⑩ Flasher light lead (Left)
- ⑪ Speedometer cable
- ⑫ Tachometer cable
- ⑬ Flasher light lead (Right)
- ⑭ Headlight lead (Auxiliary light)
- ⑮ Headlight lead

- A** Do not clamp the lead tightly when turning the handlebars.
- B** Pass the speedometer cable through the cable guide.

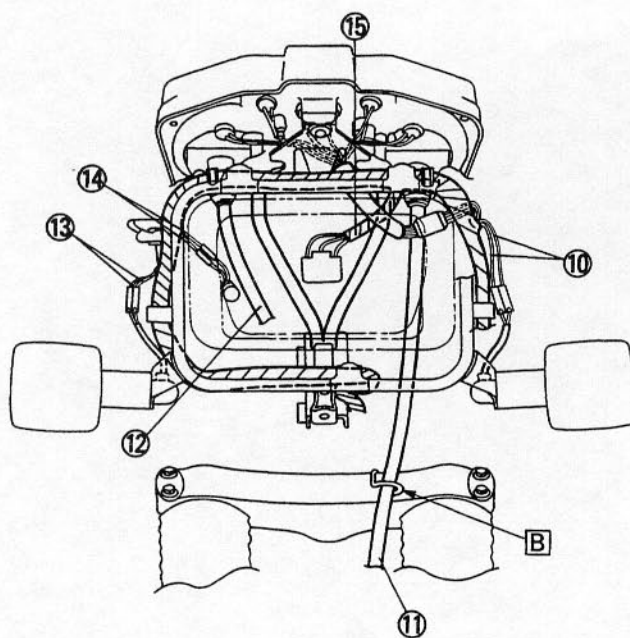
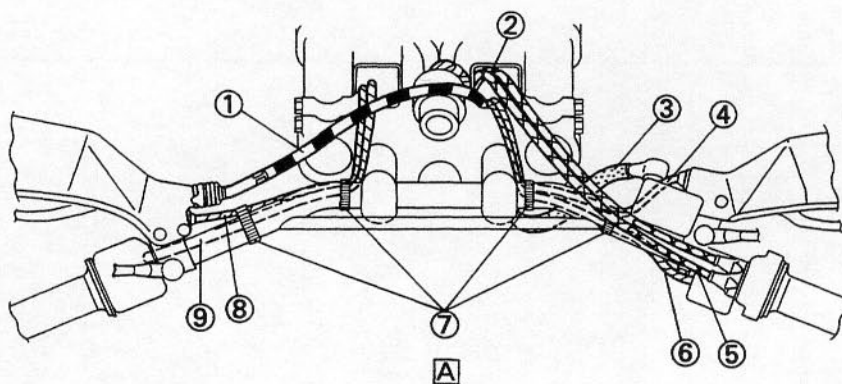



- ① Handlebar switch lead (Right)
- ② Front brake switch lead
- ③ Throttle cable
- ④ Main switch lead
- ⑤ Plate
- ⑥ Rectifier/regulator
- ⑦ Band
- ⑧ Horn
- ⑨ High tension cord
- ⑩ Spark plug cap
- ⑪ Cable holder
- ⑫ Tachometer cable
- ⑬ Throttle cable
- ⑭ Clutch cable
- ⑮ Front brake switch lead
- ⑯ Main switch lead
- ⑰ Handlebar switch lead (Right)
- ⑱ Recovery tank breather hose
- ⑲ Recovery tank conduction hose
- ⑳ Rear brake switch
- ㉑ Master cylinder
- ㉒ Reservoir tank
- ㉓ Clamp
- ㉔ Ignition coil
- ㉕ Conduction
- ㉖ Earth lead
- ㉗ Rectifier/regulator
- ㉘ Plate
- ㉙ Main harness
- ㉚ Cowling stay

- A Connect to the rectifier/regulator
- B Pass the tachometer cable inside of all the cables and harnesses. (Side of head pipe)
- C Pass the tachometer cable through the cable guide.
- D Pass the throttle cable through the cable guide.
- E Pass through the cable guide (View B-B).
- F Clamp the clutch cable to the holder.
- G Clamp the rear brake switch lead.
- H Insert the end of the air vent hose into the frame.
- I Clip (Insert the recovery tank hose and clamp securely.)
- J Cable guide (Pass all the cables and harnesses inside of it.)
- K Cable guide (Pass the brake hose.)
- L Pass the recovery tank breather hose through the frame bracket.
- M Pass through the cable guide (View B-B).
- N To conduction

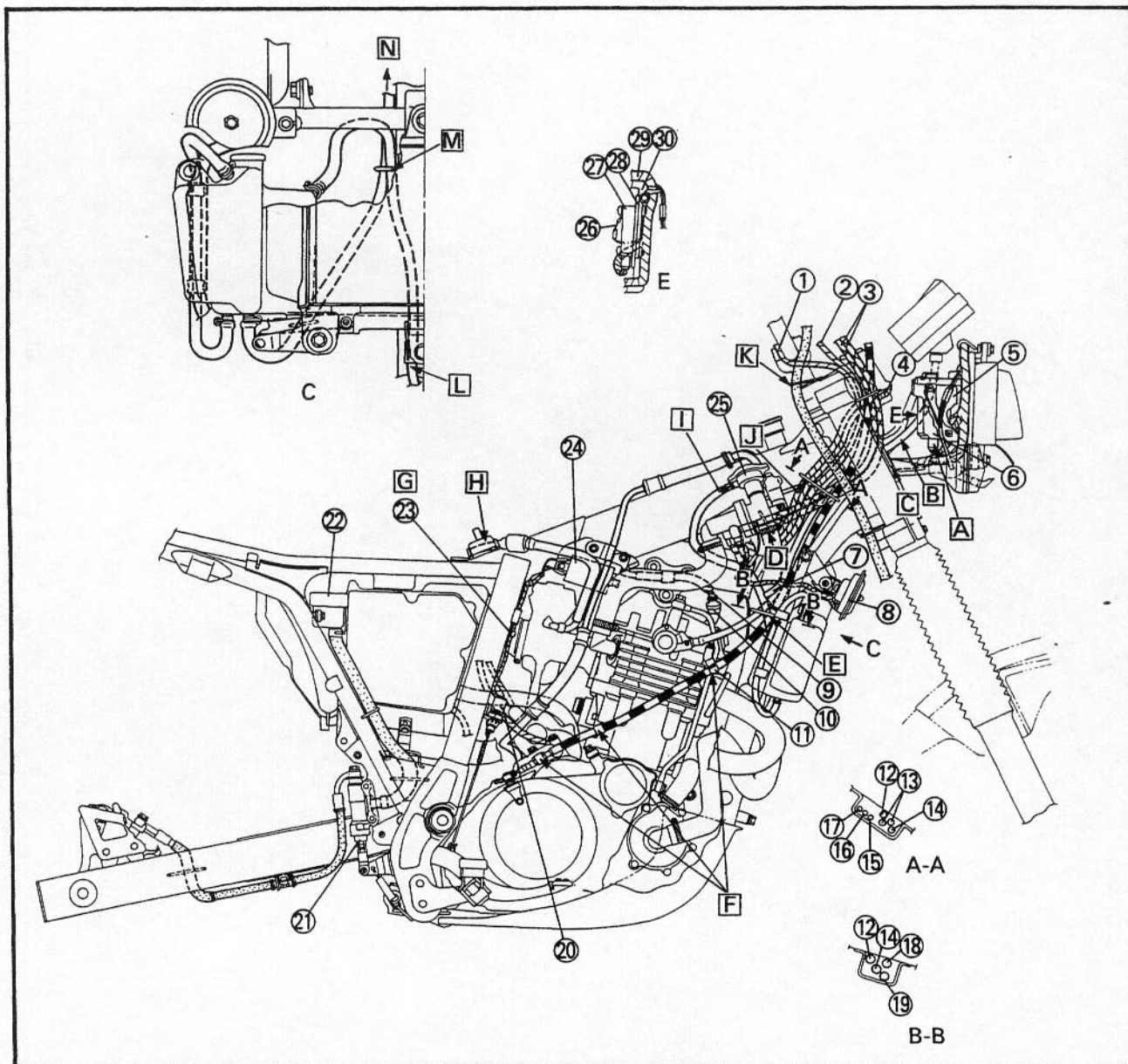



- ① Clamp
- ② Clutch switch lead
- ③ Handlebar switch lead (Left)
- ④ Starter cable
- ⑤ Clip
- ⑥ Clamp
- ⑦ Oil tank breather hose
- ⑧ Battery ⊕ lead
- ⑨ Battery ⊖ lead
- ⑩ Starter lead
- ⑪ Starter relay assembly
- ⑫ Sidestand switch lead
- ⑬ Clamp
- ⑭ Sidestand switch
- ⑮ Cable guide
- ⑯ Fan motor lead (Radiator)
- ⑰ Clamp
- ⑱ Speedometer cable
- ⑲ Brake hose
- ⑳ Relay

- A Clamp the main harness (Left and right)
- B Insert the hose until stops and clamp securely.
- C Clamp the main harness and the starter cable.
- D Clamp the main harness.
- E Pass the oil tank breather hose.
- F Connect the AC magneto lead and the wireharness.
- G Clamp the sidestand switch lead.
- H Clamp the sidestand switch lead securely.
- I Do not pinch the sidestand switch lead when installing the rear footrest.
- J Clamp the flywheel magneto lead and the overflow pipe.
- K Clamp the vacuum pipe.
- L Insert the radiator breather hose inside of the engine protector.
- M Pass the radiator breather hose.
- N Pass the radiator breather hose to the right side of the radiator bracket.
- O Clamp the fan motor lead.
- P Fit the locating hole of the band to the projection inside of the front fork.
- Q Clamp the main harness.
- R Connect to the relay.

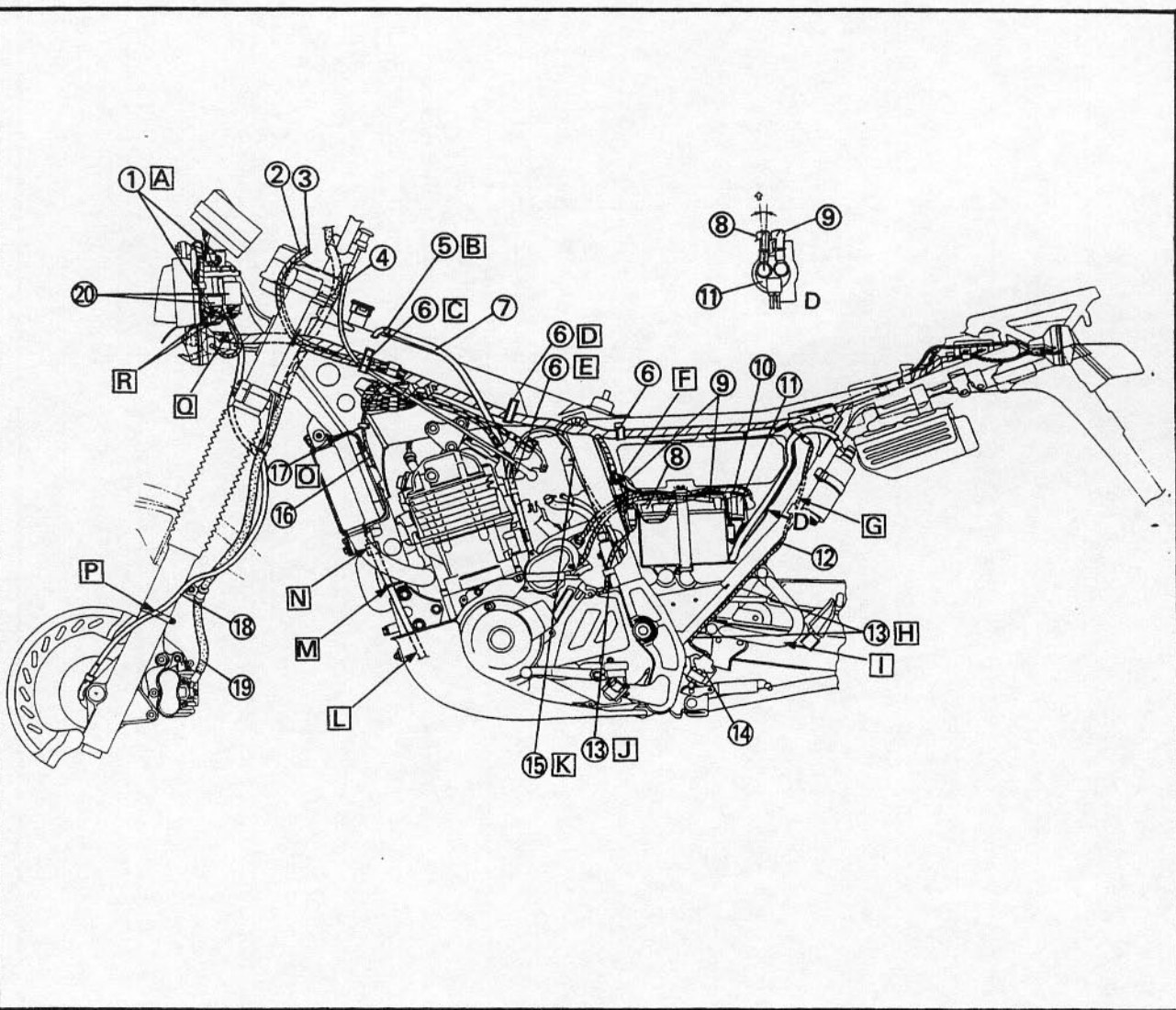



# CABLE ROUTING

SPEC



- ① Ignitor unit
- ② Clamp

- A Clamp the rear flasher light lead (Right).
- B Connect the rearflasher light lead (Right) and the wireharness.
- C Pass through the rear fender hole (Left and right).
- D Connect the taillight lead and the wireharness.
- E Connect to the ignitor unit.
- F Pass the rear flasher light lead (Left) under the wire harness and clamp:
- G Connect the rear flasher light lead (Left) and the wireharness.
- H Clamp the main harness.

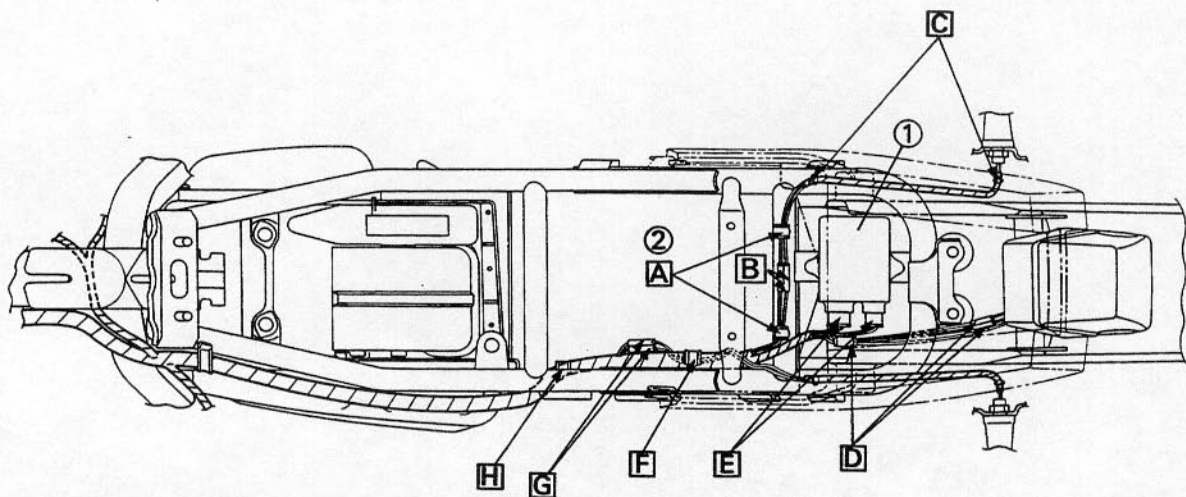



## CHAPTER 3. PERIODIC INSPECTION AND ADJUSTMENT

<b>INTRODUCTION</b> .....	C-3
<b>PERIODIC MAINTENANCE/LUBRICATION INTERVALS</b> .....	C-3
<b>SEAT, FUEL TANK AND COVER</b> .....	C-4
REMOVAL .....	C-4
INSTALLATION .....	C-5
<b>COWLING</b> .....	C-5
REMOVAL .....	C-5
INSTALLATION .....	C-6
<b>ENGINE</b> .....	C-7
VALVE CLEARANCE ADJUSTMENT .....	C-7
CAM CHAIN ADJUSTMENT .....	C-8
IDLING SPEED ADJUSTMENT .....	C-8
THROTTLE CABLE FREE PLAY ADJUSTMENT .....	C-9
SPARK PLUG INSPECTION .....	C-10
IGNITION TIMING CHECK .....	C-10
COMPRESSION PRESSURE MEASUREMENT .....	C-11
ENGINE OIL LEVEL INSPECTION .....	C-12
ENGINE OIL REPLACEMENT .....	C-13
OIL PRESSURE INSPECTION .....	C-15
CLUTCH ADJUSTMENT .....	C-15
AIR FILTER CLEANING .....	C-16
CARBURETOR JOINT INSPECTION .....	C-16
FUEL LINE INSPECTION .....	D-1
CRANKCASE VENTILATION HOSE INSPECTION .....	D-1
EXHAUST SYSTEM INSPECTION .....	D-1
COOLANT LEVEL INSPECTION .....	D-1
COOLANT REPLACEMENT .....	D-2
COOLING SYSTEM INSPECTION .....	D-4
<b>CHASSIS</b> .....	D-4
FRONT BRAKE ADJUSTMENT .....	D-4
REAR BRAKE ADJUSTMENT .....	D-5
BRAKE FLUID LEVEL INSPECTION .....	D-5
BRAKE PAD INSPECTION .....	D-6
BRAKE LIGHT SWITCH ADJUSTMENT .....	D-6
BRAKE HOSE INSPECTION .....	D-6
AIR BLEEDING (HYDRAULIC BRAKE SYSTEM) .....	D-7
DRIVE CHAIN SLACK ADJUSTMENT .....	D-7
DRIVE CHAIN LUBRICATION .....	D-8
STEERING HEAD ADJUSTMENT .....	D-9
FRONT FORK INSPECTION .....	D-10
REAR SHOCK ABSORBER ADJUSTMENT .....	D-10

---

TIRE INSPECTION .....	D-11
WHEEL INSPECTION .....	D-13
SPOKES INSPECTION AND TIGHTENING.....	D-13
CABLE INSPECTION AND LUBRICATION.....	D-13
LEVER AND PEDAL LUBRICATION .....	D-13
SIDESTAND LUBRICATION .....	D-13
REAR SUSPENSION LUBRICATION .....	D-14
<b>ELECTRICAL .....</b>	<b>D-14</b>
BATTERY INSPECTION .....	D-14
FUSE INSPECTION .....	E-1
HEADLIGHT BEAM ADJUSTMENT .....	E-2
HEADLIGHT BULB REPLACEMENT .....	E-2



# INTRODUCTION/PERIODIC MAINTENANCE/ LUBRICATION INTERVALS



## PERIODIC INSPECTION AND ADJUSTMENT

### INTRODUCTION

This chapter includes all information necessary to perform recommended inspections and adjustments. These preventive maintenance procedures, if followed, will ensure more reliable vehicle operation and a longer service life. The need for costly overhaul work will be greatly reduced. This information applies to vehicles already in service as well as new vehicles that are being prepared for sale. All service technicians should be familiar with this entire chapter.

### PERIODIC MAINTENANCE/LUBRICATION INTERVALS

Unit (miles)

ITEM	REMARKS	BREAK-IN 1,000 (600)	EVERY	
			6,000 (4,000) or 6 months	12,000 (8,000) or 12 months
Valvs(s)*	Check valve clearance. Adjust if necessary	○	○	○
Spark plug(s)	Check condition. Clean or replace if necessary.	○	○	○
Air filter	Clean. Replace if necessary.		○	○
Carburetor*	Check idle speed/starter operation. Adjust if necessary.	○	○	○
Fuel line*	Check fuel hose for cracks or damage. Replace if necessary.		○	○
Engine oil	Replace (Warm engine before draining).	○	○	○
Engine oil filter*	Replace.	○	○	○
Engine oil strainer*	Clean.	○	○	○
Brake*	Check operation/fluid leakage/See NOTE. Correct if necessary.		○	○
Clutch	Check operation. Adjust if necessary.		○	○
Rear arm pivot*	Check rear arm assembly for looseness. Correct if necessary. Moderately repack.***	○	○	○
Rear suspension link pivot*	Check operation. Modelately repack***	○	○	○
Wheels*	Check bearings/damage/runout/Spoke tightness. Repair if necessary.		○	○
Wheel bearings*	Check bearings assembly for looseness/damage. Replace if damaged.	○		○
Steering bearings*	Check bearings assembly for looseness. Correct if necessary. Modelately repack every 24,000 (16,000) or 24 months.**	○		○
Front forks*	Check operation/oil leakage. Repair if necessary.		○	○
Rear shock absorber*	Check operation/oil leakage. Repair if necessary.		○	○
Cooling system	Check coolant leakage. Repair if necessary. Replace coolant every 24,000 (16,000) or 24 months.		○	○

# PERIODIC MAINTENANCE/ LUBRICATION INTERVALS



Unit: km (miles)

ITEM	REMARKS	BREAK-IN 1,000 (600)	EVERY	
			6,000 (4,000) or 6 months	12,000 (8,000) or 12 months
Drive chain	Check chain slack/alignment. Adjust if necessary. Chain and lube.		EVERY 500 (300)	
Fittings/Fasteners*	Check all chassis fitting and fasteners. Correct if necessary.	○	○	○
Sidestand*	Check operation. Repair if necessary.	○	○	○
Sidestand switch*	Check operation. Clean or replace if necessary.	○	○	○

\*: It is recommended that these items be serviced by a Yamaha dealer.

\*\* : Medium weight wheel bearing grease.

\*\*\*: Molybdenum disulfide grease.

**NOTE:** \_\_\_\_\_

**Brake system:**

1. When disassembling the master cylinder or caliper cylinder, replace the brake fluid. Normally check the brake fluid level and add the fluid as required.
2. We recommended that, on the inner parts of the master cylinder and caliper cylinder, replace the oil seals every two years.
3. We recommended that replace the brake hoses every four years, or if cracked or damaged.



## SEAT, FUEL TANK AND COVER REMOVAL

### **⚠ WARNING**

Securely support the motorcycle so there is no danger of it falling over.

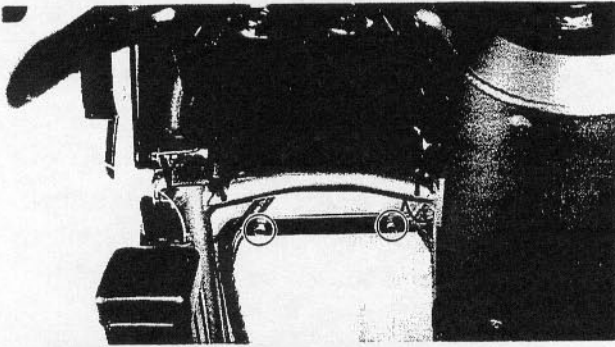

1. Remove:

- Seat

2. Remove:

- Side cover (left) ①

### **NOTE:**

When removing the side cover (left), remove the bolt ②. Then pull the front and rear portion of the side cover outward to remove the projection ③ from the grommet.

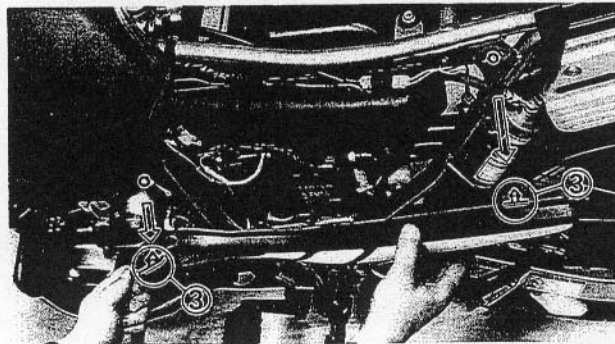
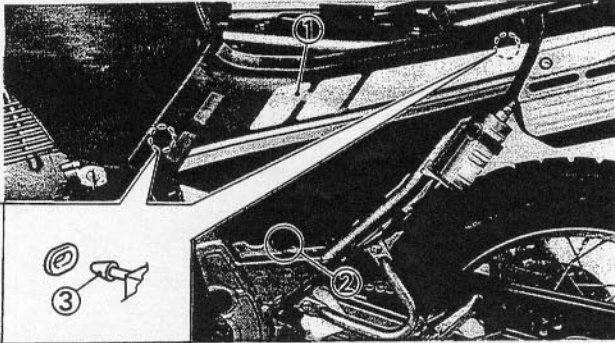

3. Remove:

- Side cover (right) ①

### **NOTE:**

When removing the side cover (right), remove the bolt ②. Then pull the front portion of the side cover outward to remove the projection ③ from the grommet. Then remove the side cover by pulling the rear portion ④ upward.

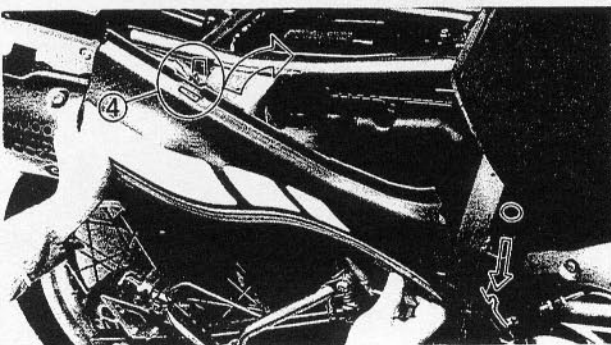
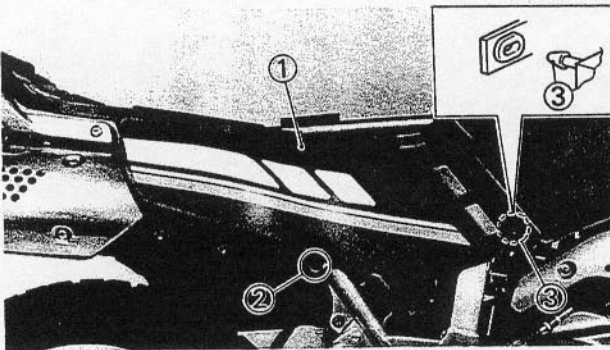



# SEAT, FUEL TANK AND COVER

INSP  
ADJ

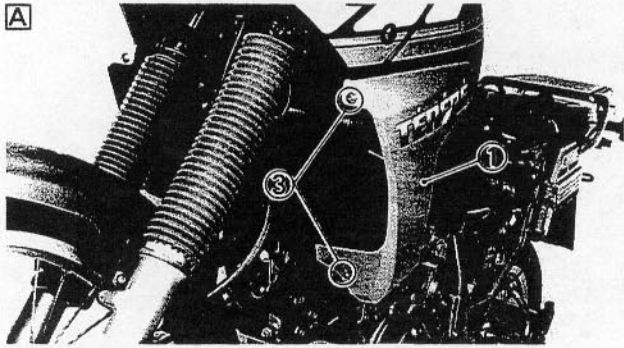

4. Remove:

- Air scoop (left) ①
- Air scoop (right) ②

**NOTE:** \_\_\_\_\_

When removing the air scoops, remove the bolt ③. Then pull the rear portion ④ of the air scoop forward to remove the air scoop from the fuel tank.

---

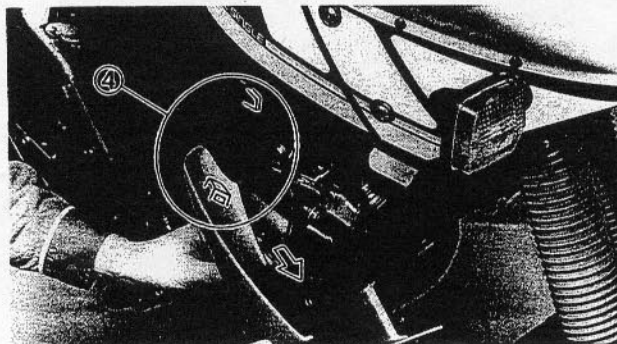
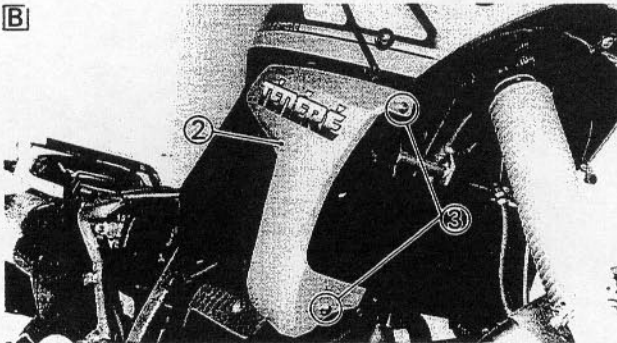
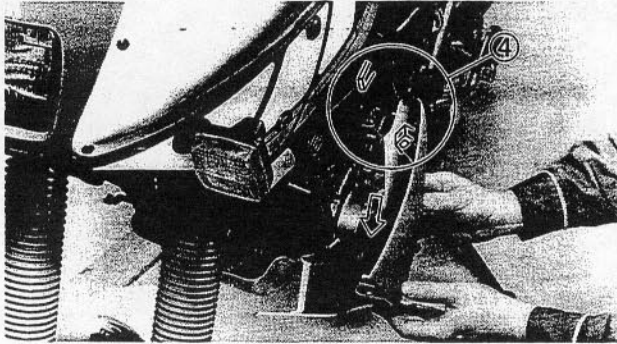

- A** Air scoop (left)  
**B** Air scoop (right)

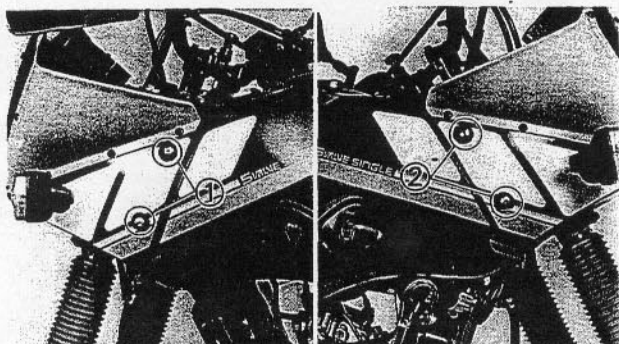

5. Remove:

- Bolt ① (cowling and fuel tank)
- Bolt ② (cowling and fuel tank)

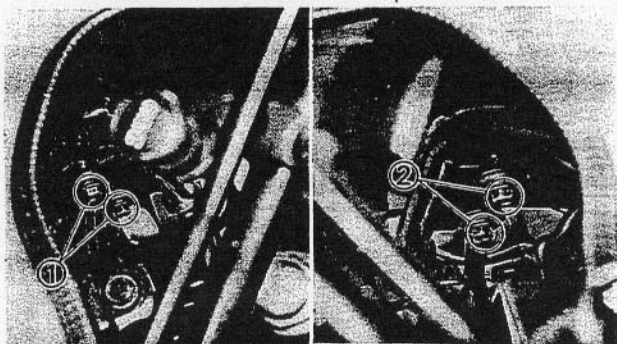

6. Remove:

- Bolt ① (fuel tank)
- Bolt ② (fuel tank)

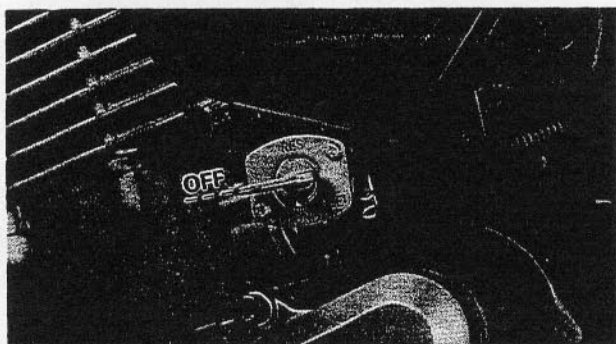

7. Turn the fuel cock to "OFF".

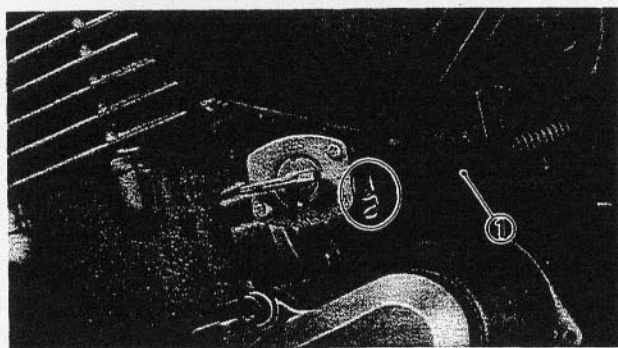

8. Disconnect:

- Fuel hose ①

**NOTE:** \_\_\_\_\_

Place a rag on the engine to absorb a spilt fuel.

**⚠ WARNING** \_\_\_\_\_

**Gasoline is highly flammable.**

**Avoid spilling fuel on the hot engine.**

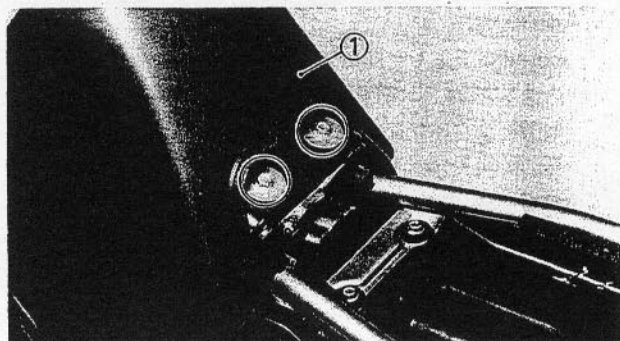

9. Remove:

- Fuel tank ①



## INSTALLATION

Reverse the "REMOVAL" procedure. Note the following points.

### 1. Install:

- Fuel tank
- Bolts (cowling and fuel tank)
- Air scoops



**Bolts (fuel tank):**

**7 Nm (0.7 m•kg, 5.1 ft•lb)**

**Bolts (cowling and fuel tank):**

**7 Nm (0.7 m•kg, 5.1 ft•lb)**

### 2. Install:

- Side covers
- Seat



**Bolt (side cover):**

**7 Nm (0.7 m•kg, 5.1 ft•lb)**

**Bolt (seat):**

**10 Nm (1.0 m•kg, 7.2 ft•lb)**

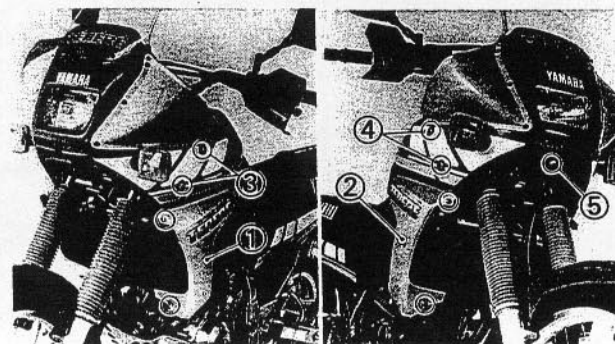
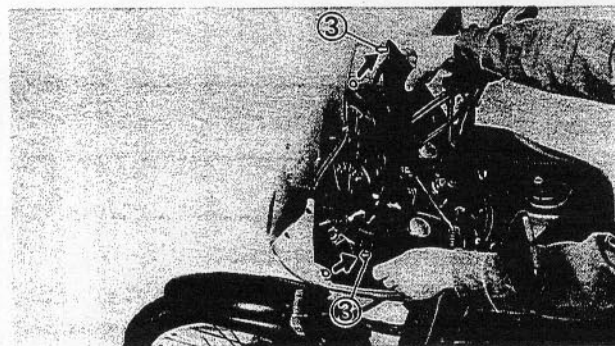
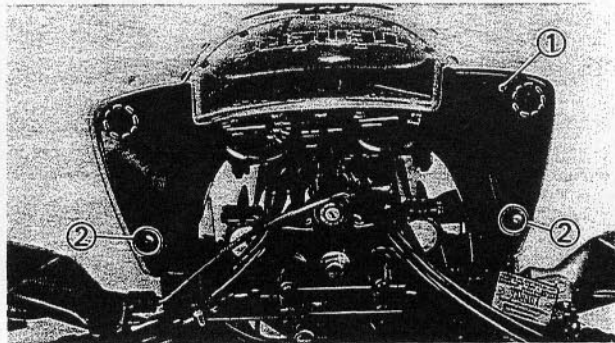
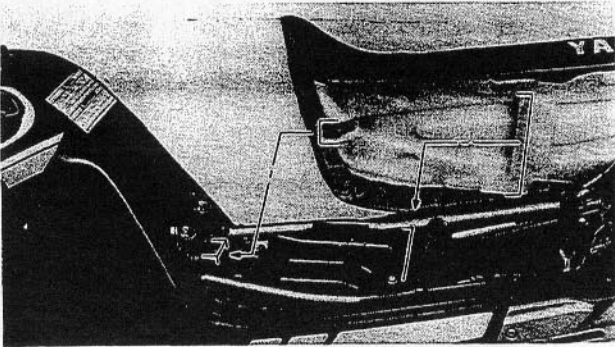

## COWLING REMOVAL

### 1. Remove:

- Inner panel ①

### NOTE:

When removing the inner panel ①, remove the bolts ②. Then pull the projections ③ from the grommets.

### 2. Remove:

- Air scoop (left) ①
- Air scoop (right) ②
- Bolt ③ (cowling and fuel tank)
- Bolt ④ (cowling and fuel tank)

Refer to the "SEAT, FUEL TANK AND COVER" section.

- Bolt ⑤ (cowling and cowling stay)



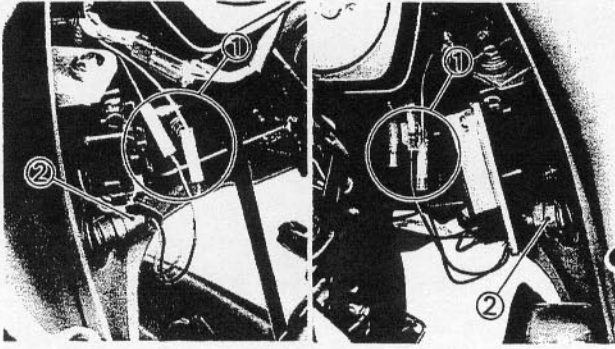

3. Disconnect:
- Front flasher light leads ①
  - Rubber covers ②

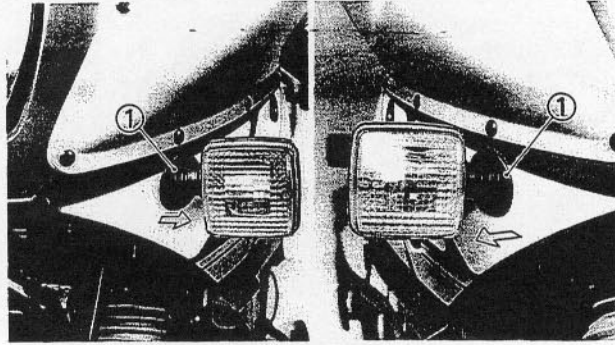

4. Remove:
- Rubber dampers ①

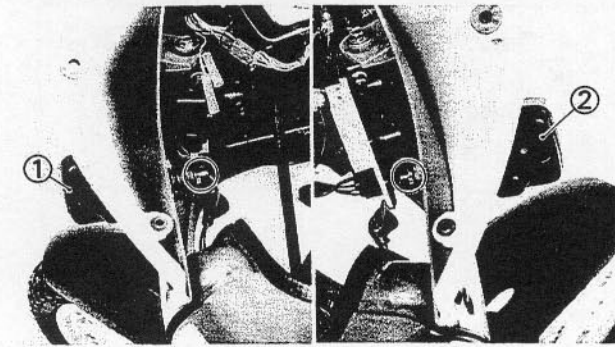

5. Remove:
- Front flasher light (left) ①
  - Front flasher light (right) ②

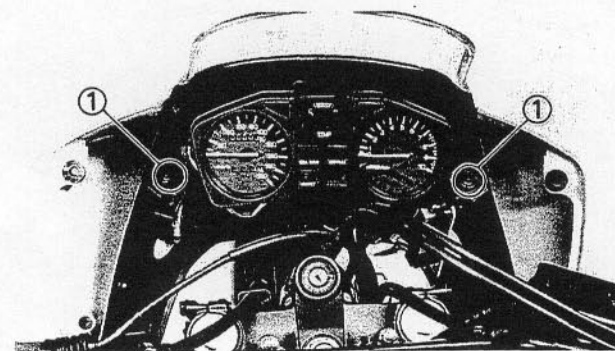

6. Remove:
- Bolt ① (cowling and cowling stay)

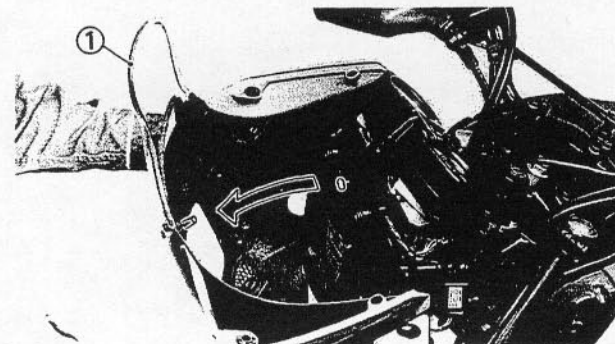

7. Remove:
- Cowling ①

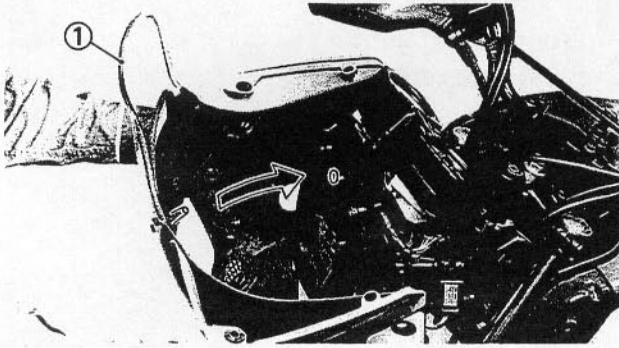
**INSTALLATION**

Reverse the "REMOVAL" procedure.  
Note the following points.

1. Install:
  - Cowling ①
  
2. Install:
  - Bolts (cowling and cowling stay)
  - Front flasher lights
  - Rubber damper
  
3. Connect:
  - Rubber covers (front flasher light)
  - Front flasher light leads
  
4. Install:
  - Air scoops
  - Bolts (cowling and fuel tank)
  - Inner panel



**Bolts (cowling and cowling stay):**

**7 Nm (0.7 m•kg, 5.1 ft•lb)**

**Bolts (cowling and fuel tank):**

**7 Nm (0.7 m•kg, 5.1 ft•lb)**



## ENGINE

### VALVE CLEARANCE ADJUSTMENT

#### NOTE:

- The valve clearance must be adjusted when the engine is cool to the touch.
- Adjust the valve clearance when the piston is at the Top Dead Center (T.D.C.) on compression stroke.

#### **⚠ WARNING**

Securely support the motorcycle so there is no danger of it falling over.

#### 1. Remove:

- Seat
- Side covers
- Air scoops
- Fuel tank

Refer to the "SEAT, FUEL TANK AND COVER" section.

#### 2. Remove:

- Bolt ① (radiator stay)
- Bolt ② (radiator)

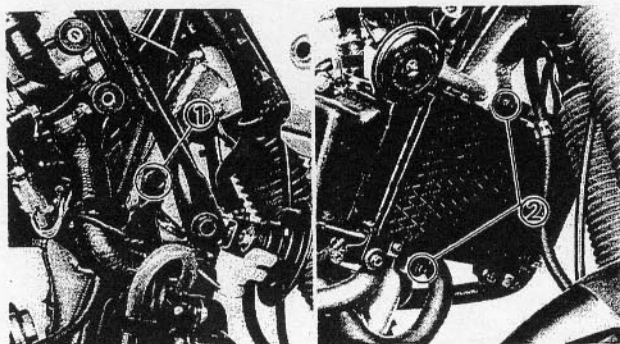

#### 3. Disconnect:

- Leads (ignition coil) ①
- Plug cap ②

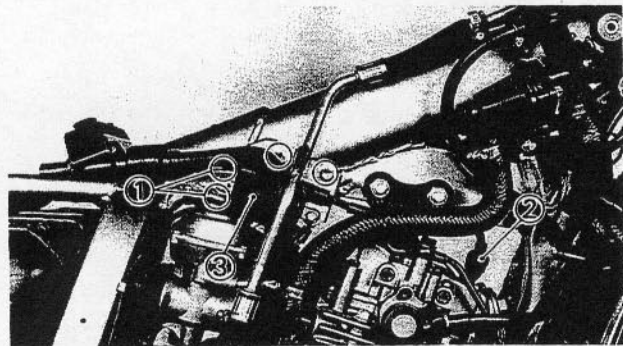

#### 4. Remove:

- Ignition coil ③

#### 5. Remove:

- Tappet cover ① (intake)
- Tappet cover ② (exhaust)

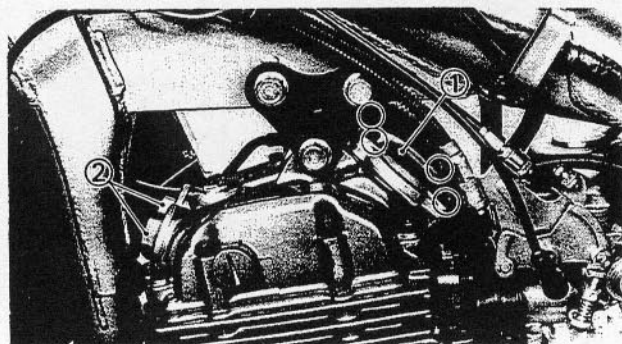



# VALVE CLEARANCE ADJUSTMENT

INSP  
ADJ

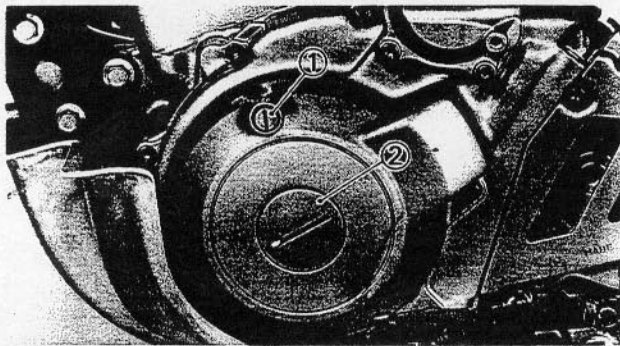

6. Remove:
- Plug ①
  - Plug ②

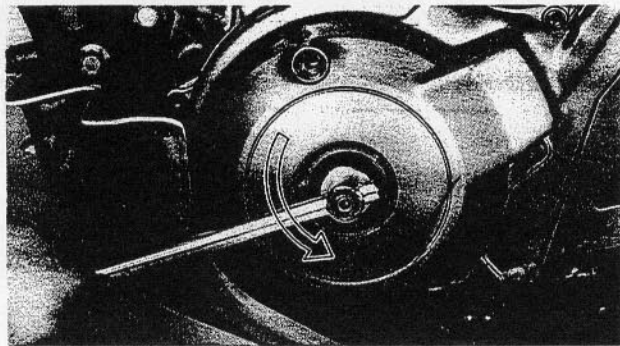

7. Turn the crankshaft counterclockwise with a wrench.

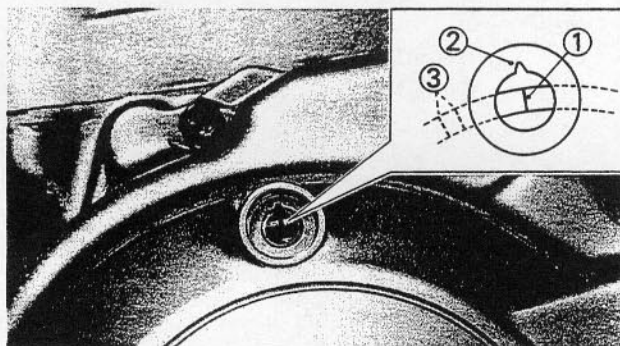

8. Align:
- "T" mark ①
- With stationary pointer ②.

**NOTE:** \_\_\_\_\_  
Make sure the piston is at the T.D.C. on compression stroke.

③ Ignition timing mark

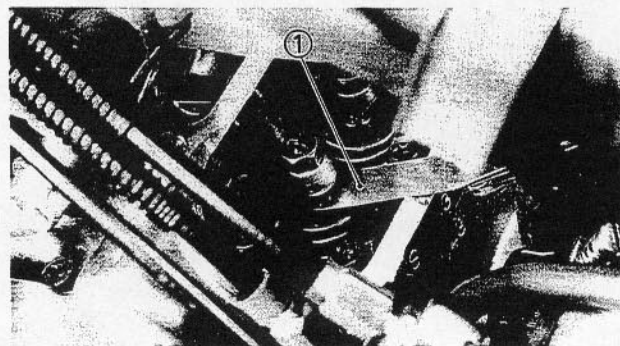

9. Check:
- Valve clearance
- Measure the valve clearance by using a feeler gauge ①.
- Out of specification → Adjust.



**Valve clearance (cold):**

**Intake:**

0.10 ~ 0.15 mm (0.004 ~ 0.006 in)

**Exhaust:**

0.15 ~ 0.20 mm (0.006 ~ 0.008 in)

# VALVE CLEARANCE ADJUSTMENT

**INSP**  
**ADJ**

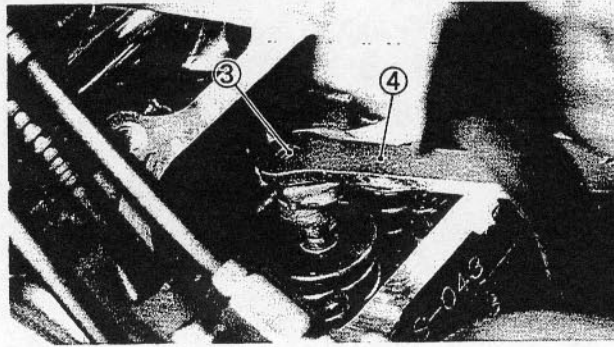
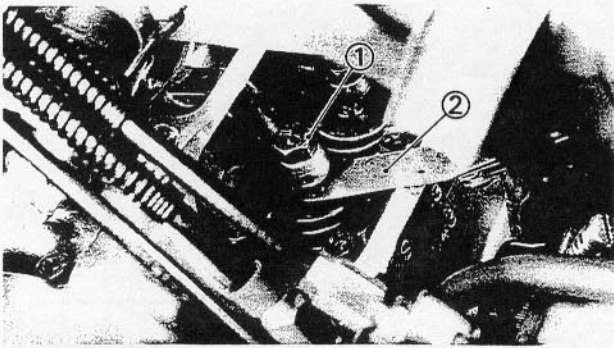

## 10. Adjust:

- Valve clearance

\*\*\*\*\*

### Adjustment steps:

- Loosen the locknut (1).
- Insert a Feeler Gauge (2) between the adjuster end and the valve end.
- Turn the adjuster (3) clockwise or counter-clockwise with the valve adjusting tool (4) until proper clearance is obtained.



**Valve adjusting tool:**  
**P/N. YM-08035**  
**P/N. 90890-01311**

- Hold the adjuster to prevent it from moving and thoroughly tighten the locknut.



**Locknut:**  
**14 Nm (1.4 m•kg, 10 ft•lb)**

- Measure the valve clearance.
- If the clearance is incorrect, repeat above steps until the proper clearance is obtained.

\*\*\*\*\*

## 11. Install:

Reverse removal steps.

- Plugs
- Tappet cover (intake)
- Tappet cover (exhaust)



**Tappet cover (exhaust):**  
**12 Nm (1.2 m•kg, 8.7 ft•lb)**  
**Bolt (tappet cover-intake):**  
**10 Nm (1.0 m•kg, 7.2 ft•lb)**

## 12. Install:

- Ignition coil

## 13. Connect:

- Leads (ignition coil)
- Spark plug cap

## 14. Install:

- Bolts (radiator)
- Bolt (radiator stay)



## 15. Install:

- Fuel tank
- Air scoops
- Side covers
- Seat

Refer to the "SEAT, FUEL TANK AND COVER" section.



**Bolts (fuel tank, cowling and fuel tank, side cover):**

**7 Nm (0.7 m•kg, 5.1 ft•lb)**

**Bolt (seat):**

**10 Nm (1.0 m•kg, 7.2 ft•lb)**

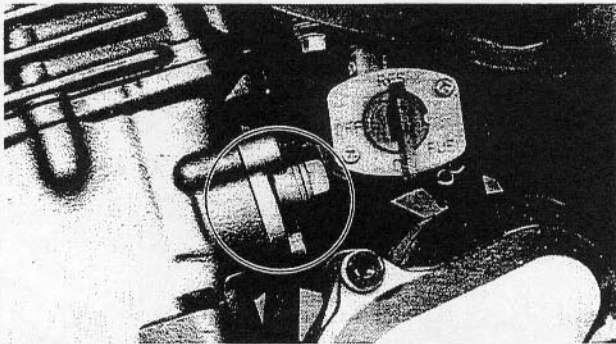

## CAM CHAIN ADJUSTMENT

Adjustment free.

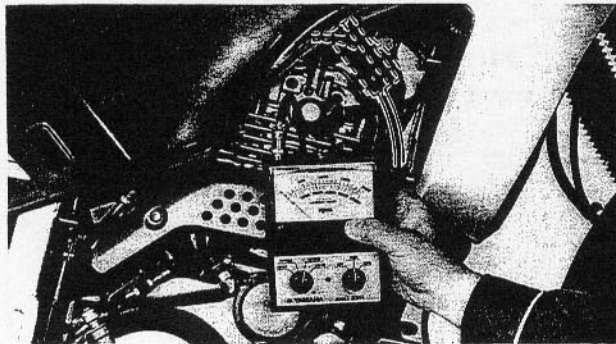

## IDLING SPEED ADJUSTMENT

1. Start the engine and let it warm up for several minutes.
2. Attach:
  - Inductive tachometer to the spark plug lead.



**Inductive tachometer**

**P/N. YU-08036-A**

**P/N. 90890-03113**

## 3. Check:

- Engine idling speed  
Out of specification → Adjust.



**Engine idling speed:**

**1,250 ~ 1,350 r/min**



# THROTTLE CABLE FREE PLAY ADJUSTMENT

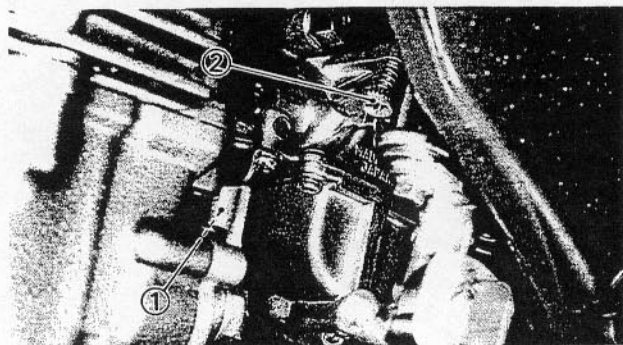

4. Adjust:
- Engine idling speed

\*\*\*\*\*

### Adjustment steps:

- Turn in the pilot screw ① until it is lightly seated.
- Turn out the pilot screw for the specified number of turns.

**Pilot screw:**  
2 and 1/2 turns out

- Turn the throttle stop screw ② in or out until specified idling speed is obtained.

Turn in → Idling speed becomes higher.  
Turn out → Idling speed becomes lower.

\*\*\*\*\*

5. Remove:
- Inductive tachometer

6. Adjust:
- Throttle cable free play
- Refer to the "THROTTLE CABLE FREE PLAY ADJUSTMENT" section.

 **Free play:**  
3~5 mm (0.12~0.20 in)

## THROTTLE CABLE FREE PLAY ADJUSTMENT

### NOTE:

Before adjusting the throttle cable free play, the engine idle speed should be adjusted.

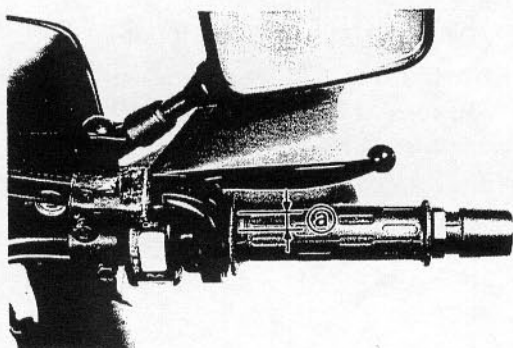

1. Check:
- Throttle cable free play ①
- Out of specification → Adjust.

 **Throttle cable free play:**  
3~5 mm (0.12~0.20 in)

# THROTTLE CABLE FREE PLAY ADJUSTMENT



## 2. Remove:

- Seat
- Side covers
- Air scoops
- Fuel tank

Refer to the "SEAT, FUEL TANK AND COVER" section.

## 3. Adjust:

- Throttle cable free play

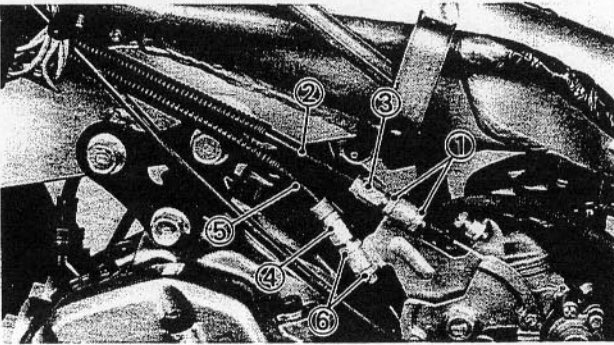

\*\*\*\*\*

### Adjustment steps:

- Loosen the locknuts ① on the throttle cable 1 ②.
- Turn the adjuster ③ clockwise or counter-clockwise until proper free play is obtained.
- If the play is still incorrect after the adjuster is loosened 5 mm (0.2 in), make an adjustment with the adjuster ④ on the throttle cable 2 ⑤.
- Tighten the locknuts.

①, ⑥ Locknuts

\*\*\*\*\*

## 4. Install:

- Fuel tank
- Air scoops
- Side covers
- Seat



**Bolts (fuel tank, cowling and fuel tank, side cover):**

**7 Nm (0.7 m•kg, 5.1 ft•lb)**

**Bolt (seat):**

**10 Nm (1.0 m•kg, 7.2 ft•lb)**

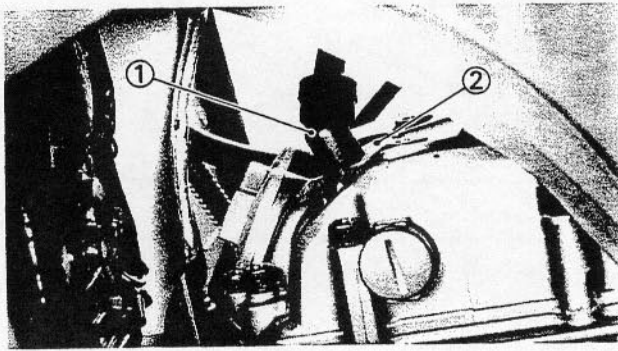

## SPARK PLUG INSPECTION

1. Disconnect:
  - Spark plug cap ①
  - Rubber cover ②

2. Remove:
  - Spark plug

### CAUTION:

When removing the spark plug, use caution to prevent an object from falling into the engine.

3. Inspect:
  - Spark plug type  
Incorrect → Replace.

**Standard spark plug:**  
DPR8EA-9 (N.G.K.), DPR9EA-9 (N.G.K.)

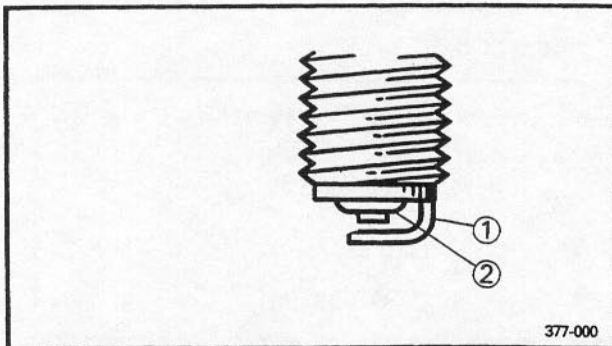

4. Inspect:
  - Electrode ①  
Wear/Damage → Replace.
  - Insulator ②  
Abnormal color → Replace.  
Normal color is a medium-to-light tan color.

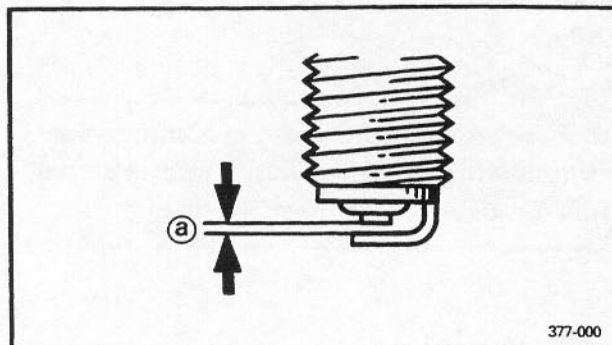

5. Clean the spark plug with a spark plug cleaner or wire brush.
6. Measure:
  - Plug gap ③  
Use a wire gauge or feeler gauge.  
Out of specification → Regap.



**Spark plug gap:**  
0.8 ~ 0.9 mm (0.031 ~ 0.035 in)



# IGNITION TIMING CHECK

INSP  
ADJ



7. Tighten:
- Spark plug(s)



**Spark plug:**  
17.5 Nm (1.75 m•kg, 12.5 ft•lb)

**NOTE:** \_\_\_\_\_

- Before installing a spark plug, clean the gasket surface and plug surface.
- If a torque wrench is not available when you are installing a spark plug, a good estimate of the correct torque is 1/4 to 1/2 turns part finger tight. Have the spark plug torqued to the correct value as soon as possible with a torque wrench.

8. Connect:

- Spark plug cap
- Rubber cover

## IGNITION TIMING CHECK

**NOTE:** \_\_\_\_\_

Engine idling speed and throttle cable free play should be adjusted properly before checking the ignition timing.

1. Start the engine and let it warm up for several minutes.
2. Attach:
  - Inductive tachometer
  - Timing light to spark plug lead.



**Inductive tachometer:**  
P/N. YU-08036-A  
P/N. 90890-03113  
**Timing light:**  
P/N. YM-33277-A  
P/N. 90890-03109

3. Remove:
  - Plug ①

**CAUTION:** \_\_\_\_\_

Under extreme conditions, the oil may spurt out when removing the plug. Therefore care should be used when removing.

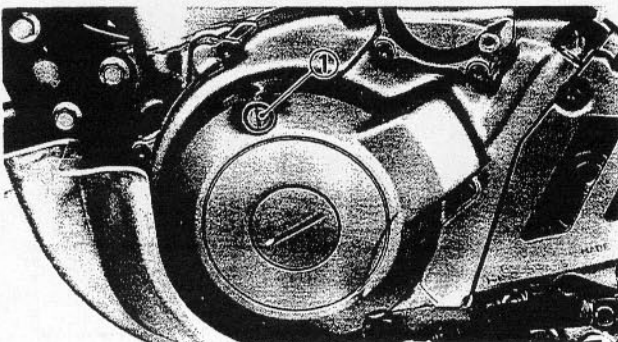

# COMPRESSION PRESSURE MEASUREMENT

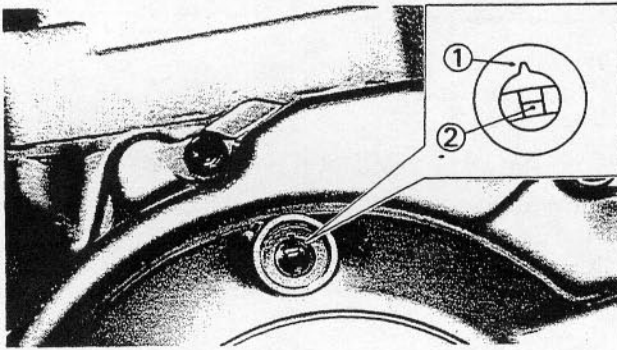

4. Check:
- Ignition timing

\*\*\*\*\*

### Checking steps:

- Warm up the engine and let it run at the specified speed.

	<b>Engine speed:</b> 1,300 r/min
--	-------------------------------------

- Visually check the stationary pointer (1) to verify it is within the required firing range (2) indicated on the flywheel.

Incorrect firing range → Check pickup assembly.

**NOTE:** \_\_\_\_\_

Ignition timing is not adjustable.

\*\*\*\*\*

5. Install:
- Plug
6. Detach:
- Timing light
  - Inductive tachometer

# COMPRESSION PRESSURE MEASUREMENT

**NOTE:** \_\_\_\_\_

Insufficient compression pressure will result in performance loss.

1. Remove:
- Seat
  - Side covers
  - Air scoops
  - Fuel tank
- Refer to the "SEAT, FUEL TANK AND COVER" section.
2. Check:
- Valve clearance
- Out of specification → Adjust.  
Refer to the "VALVE CLEARANCE ADJUSTMENT" section.

# COMPRESSION PRESSURE MEASUREMENT



3. Install:
  - Sub tank (fuel)
4. Start the engine and let it warm up for several minutes.
5. Stop the engine.
6. Disconnect:
  - Spark plug cap
  - Rubber cover
7. Remove:
  - Spark plugRefer to the "SPARK PLUG INSPECTION" section.

8. Attach:
  - Compression gauge ①
  - Adapter ②

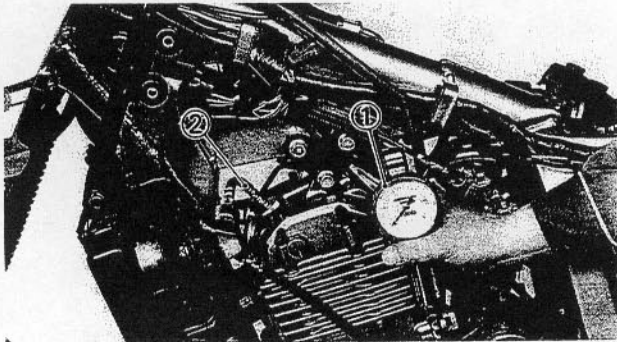

**Compression gauge:**

P/N. YU-33223

P/N. 90890-03081

**Adapter:**

P/N. YU-33223-3

P/N. 90890-04082

9. Check:
  - Compression pressure

\*\*\*\*\*

## Checking steps:

- Crank over the engine with the electric starter (be sure the battery is fully charged) with the throttle wide-open until the compression reading on the gauge stabilizes.

## **⚠ WARNING**

**When cranking the engine, ground the spark plug lead to prevent sparking.**

- Check reading with specified levels (see chart).



**Compression pressure (at sea level):**  
**Standard:**  
 1,100 kPa (11 kg/cm<sup>2</sup>, 156 psi)  
**Minimum:**  
 900 kPa (9 kg/cm<sup>2</sup>, 128 psi)  
**Maximum:**  
 1,200 kPa (12 kg/cm<sup>2</sup>, 171 psi)

- If pressure falls below the minimum level:
  - 1) Squirt a few drops of oil into the affected cylinder.
  - 2) Measure the compression again.

Compression pressure (with oil introduced into cylinder)	
Reading	Diagnosis
Higher than without oil	Worn or damaged pistons
Same as without oil	Defective ring(s), valves, cylinder head gasket or piston is possible.
Above maximum level	Inspect cylinder head, valve surfaces, or piston crown for carbon deposits.

\*\*\*\*\*

10. Remove:
  - Sub tank (fuel)
  - Compression gauge (with an adapter)
11. Install:
  - Spark plug

	<b>Spark plug:</b> 17.5 Nm (1.75 m•kg, 12.5 ft•lb) -
---	---

Refer to the "SPARK PLUG INSPECTION" section.

12. Connect:
  - Spark plug cap
  - Rubber cover
13. Install:
  - Fuel tank
  - Air scoops
  - Side covers
  - Seat

# ENGINE OIL LEVEL INSPECTION

INSP  
ADJ



**Bolts (fuel tank, cowling and fuel tank, side cover):**

7 Nm (0.7 m•kg, 5.1 ft•lb)

**Bolt (seat):**

10 Nm (1.0 m•kg, 7.2 ft•lb)

## ENGINE OIL LEVEL INSPECTION

### CAUTION:

Do not add any chemical additives. Engine oil also lubricates the clutch and additives could cause clutch slippage.

### WARNING

Never remove the oil tank cap just after high speed operation. The heated oil could spurt out, causing danger. Wait until the oil cools down to approximately 70°C (158°F).

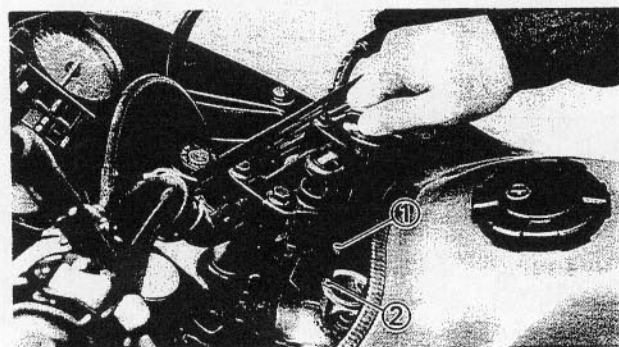
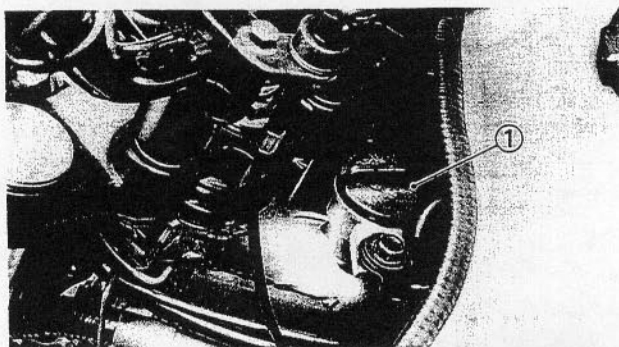

1. Place the motorcycle on a level place.

2. Remove:

- Oil tank cap ①

3. Inspect:

- Oil level

Oil level should be between the maximum level ① and minimum level ②.

### NOTE:

- Be sure the motorcycle is positioned straight up when checking the oil level.
- When inspecting the oil level, do not screw the oil level gauge into the oil tank. Insert the gauge lightly.

Oil level is incorrect → Add the oil up to the minimum level.



**Recommended oil:**

SAE 20W40 type SE motor oil or  
SAE 10W30 type SE motor oil

## ENGINE OIL REPLACEMENT

INSP  
ADJ



4. Install:
  - Oil tank cap
5. Start the engine and warm up until the oil temperature rises to approximately 70°C (158°F).

### **CAUTION:**

When the oil tank is empty, never start the engine.

6. Idle the engine more than 10 seconds while keeping the motorcycle upright. Then stop the engine and add the oil to the maximum level.
7. Install:
  - Oil tank cap



### Oil quantity:

Periodic oil change

2.6 L (2.3 Imp qt, 2.7 US qt)

With oil filter replacement

2.7 L (2.4 Imp qt, 2.9 US qt)

Total amount

3.0 L (2.6 Imp qt, 3.2 US qt)

## ENGINE OIL REPLACEMENT

### **CAUTION:**

Do not add any chemical additives. Engine oil also lubricates the clutch and additives could cause clutch slippage.

### **! WARNING**

Never remove the oil tank cap just after high speed operation. The heated oil could spurt out, causing danger. Wait until the oil cools down to approximately 70°C (158°F).



# ENGINE OIL REPLACEMENT

INSP  
ADJ

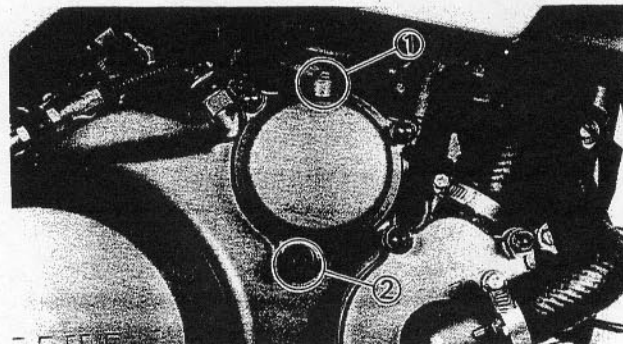
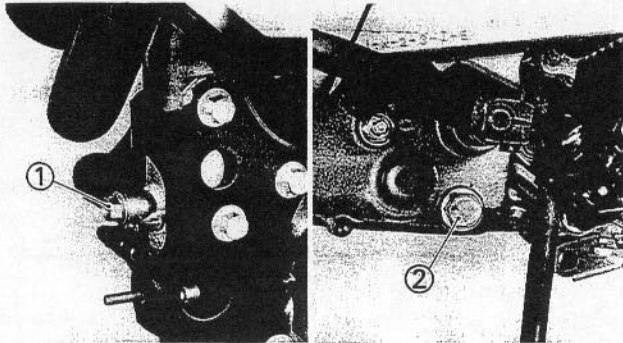
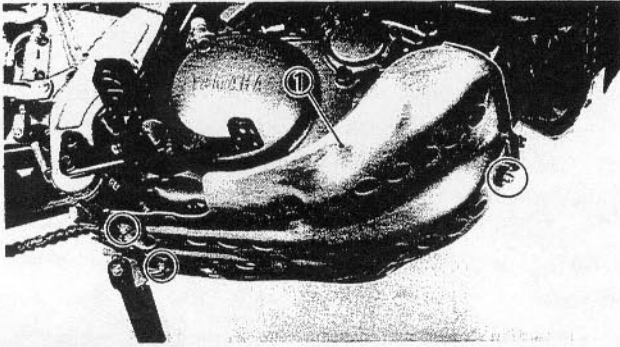

## Engine oil replacement (without oil filter)

1. Place the motorcycle on a level place.
2. Remove:
  - Engine guard ①
3. Warm up the engine for several minutes, then stop the engine. Then place a receptacle under the drain bolt.
4. Remove:
  - Oil tank cap
  - Drain bolt (oil tank) ①
  - Drain bolt (crankcase) ②
5. Drain:
  - Engine oil

### NOTE: \_\_\_\_\_

When the drain bolt ① is removed, the oil will not drain directly downward. Therefore a receptacle should be placed slightly in front of the drain bolt.

---

6. Remove:
  - Air bleed screw ①
  - Bolt ② (oil filter cover)

### NOTE: \_\_\_\_\_

The oil filter cover is secured by three screws. The lower one should be removed so that the filter cavity will drain.

---

7. Inspect:
  - Gasket (each)  
Damage → Replace.
8. Install:
  - Bolt (oil filter cover)
  - Drain bolt (oil tank)
  - Drain bolt (crankcase)



**Bolt (oil filter cover):**  
10 Nm (1.0 m•kg, 7.2 ft•lb)  
**Drain bolt (oil tank):**  
18 Nm (1.8 m•kg, 13 ft•lb)  
**Drain bolt (crankcase):**  
30 Nm (3.0 m•kg, 22 ft•lb)

9. Fill:

- Oil tank (to frame)
- Oil filter chamber



**Recommended oil:**  
SAE 20W40 type SE motor oil or  
SAE 10W30 type SE motor oil  
**Oil quantity:**  
**Oil tank**  
2.6 L (2.3 Imp qt, 2.7 US qt)  
**Oil filter chamber**  
0.06 L (0.05 Imp qt, 0.06 US qt)

**CAUTION:**

- Do not allow foreign material to enter the crankcase.
- Do not add any chemical additives. Engine oil also lubricates the clutch and additives could cause clutch slippage.

10. Install:

- Air bleed screw



**Air bleed screw:**  
5 Nm (0.5 m•kg, 3.6 ft•lb)

11. Inspect:

- Oil level  
Refer to the "ENGINE OIL LEVEL INSPECTION" section.
- Oil pressure  
Refer to the "OIL PRESSURE INSPECTION" section.
- Oil leaks

12. Install:

- Oil tank cap
- Engine guard



**Nut (engine guard):**  
7 Nm (0.7 m•kg, 5.1 ft•lb)  
**Bolt (engine guard):**  
7 Nm (0.7 m•kg, 5.1 ft•lb)

## Engine oil replacement (with oil filter)

1. Place the motorcycle on a level place.
2. Remove:
  - Engine guard
 Refer to the "ENGINE OIL REPLACEMENT (without oil filter)" section.
3. Warm up the engine for several minutes, then stop the engine. Then place a receptacle under the drain bolts.

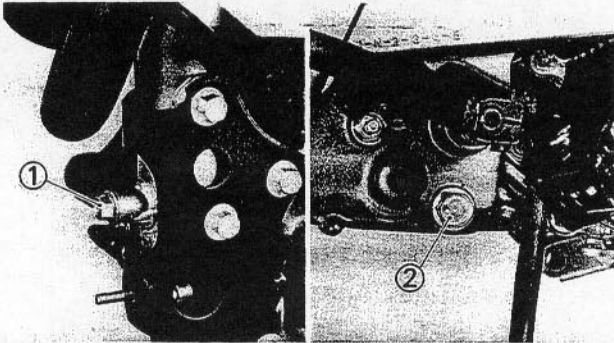

4. Remove:
  - Oil tank cap
  - Drain bolt ① (oil tank)
  - Drain bolt ② (crankcase)
5. Drain:
  - Engine oil

**NOTE:** \_\_\_\_\_  
 When the drain bolt ① is removed, the oil will not drain directly downward. Therefore a receptacle should be placed slightly in front of the drain bolt.

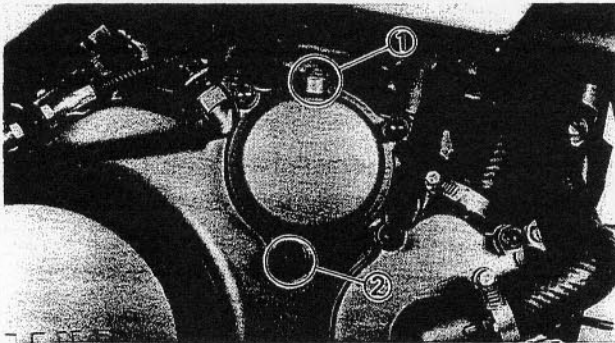

6. Remove:
  - Air bleed screw ①
  - Bolt ②

**NOTE:** \_\_\_\_\_  
 The oil filter cover is secured by three screws. The lower one should be removed so that the filter cavity will drain.

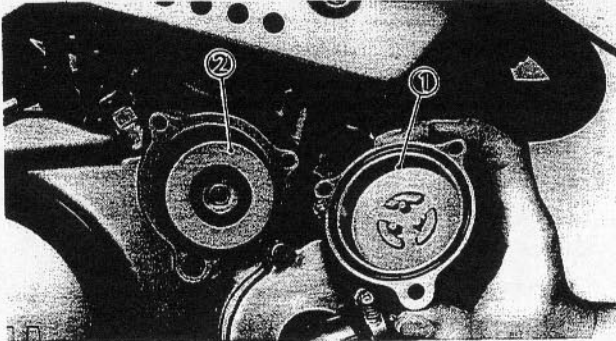

7. Remove:
  - Oil filter cover ①
  - Oil filter ②

8. Inspect:
  - Gasket (each)
  - O-ring ①
 Damage → Replace.

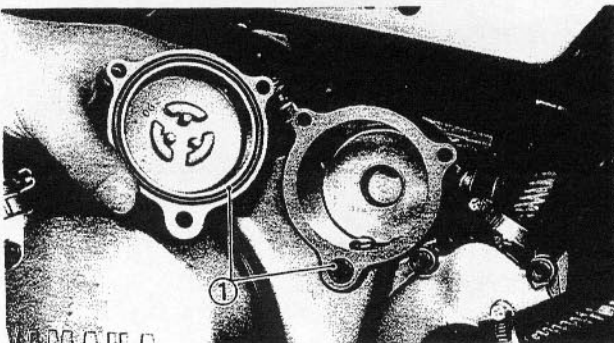



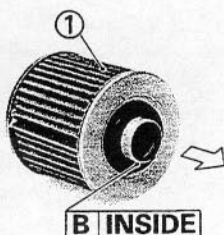
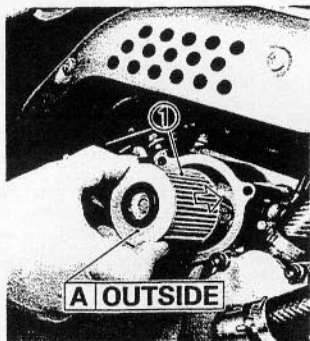

9. Install:
- Oil filter (new) ①

**CAUTION:** \_\_\_\_\_

Install the oil filter as shown.

- Oil filter cover
- Drain bolt (crankcase)
- Drain bolt (oil tank)



**Bolt (oil filter cover):**  
10 Nm (1.0 m•kg, 7.2 ft•lb)  
**Drain bolt (oil tank):**  
18 Nm (1.8 m•kg, 13 ft•lb)  
**Drain bolt (crankcase):**  
30 Nm (3.0 m•kg, 22 ft•lb)

10. Fill:
- Oil tank (to frame)
  - Oil filter chamber



**Recommended oil:**  
SAE 20W40 type SE motor oil or  
SAE 10W30 type SE motor oil  
**Oil quantity:**  
**Oil tank**  
2.7 L (2.4 Imp qt, 2.9 US qt)  
**Oil filter chamber**  
0.06 L (0.05 Imp qt, 0.06 US qt)

**CAUTION:** \_\_\_\_\_

- Do not allow foreign material to enter the crankcase.
- Do not add any chemical additives. Engine oil also lubricates the clutch and additives could cause clutch slippage.

11. Install:
- Air bleed screw



**Air bleed screw:**  
5 Nm (0.5 m•kg, 3.6 ft•lb)

12. Inspect:
- Oil level  
Refer to the "ENGINE OIL LEVEL INSPECTION" section.
  - Oil pressure  
Refer to the "OIL PRESSURE INSPECTION" section.
  - Oil leaks

### 13. Install:

- Oil tank cap
- Engine guard

	<b>Nut (engine guard):</b>
	7 Nm (0.7 m•kg, 5.1 ft•lb)
	<b>Bolt (engine guard):</b>
	7 Nm (0.7 m•kg, 5.1 ft•lb)

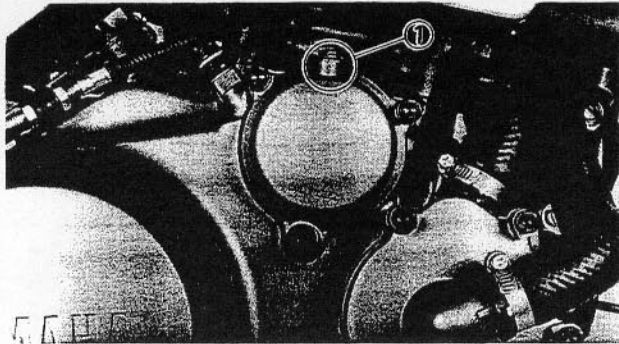

## OIL PRESSURE INSPECTION

### 1. Remove:

- Air bleed screw ①

### 2. Start the engine and keep it idling for several minutes.

### 3. Inspect:

- Oil condition of the bleed hole  
Oil flows out → Oil pressure is good.  
No oil comes out → Oil pressure is bad.

### CAUTION:

If no oil comes out after a lapse of one minute, turn off the engine immediately so it will not seize.

### 4. Tighten:

- Air bleed screw

	<b>Air bleed screw:</b>
	5 Nm (0.5 m•kg, 3.6 ft•lb)

YB2AF000

## CLUTCH ADJUSTMENT

### 1. Check:

- Clutch cable free play ①  
Out of specification → Adjust.

	<b>Free play:</b>
	10~15 mm (0.4~0.6 in)
	at clutch lever end

### 2. Adjust:

- Clutch cable free play

\*\*\*\*\*

### Adjustment steps:

- Loosen the locknut(s) ①.
- Turn the adjuster(s) ② in or out until the specified free play is obtained.

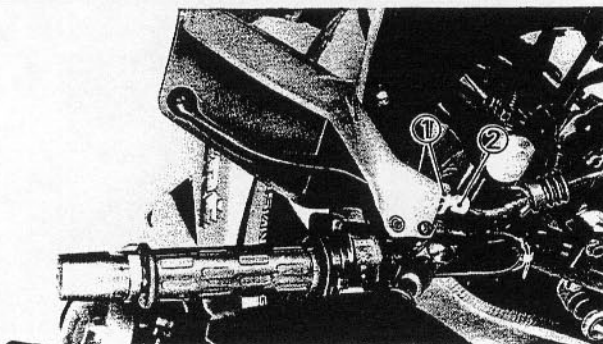
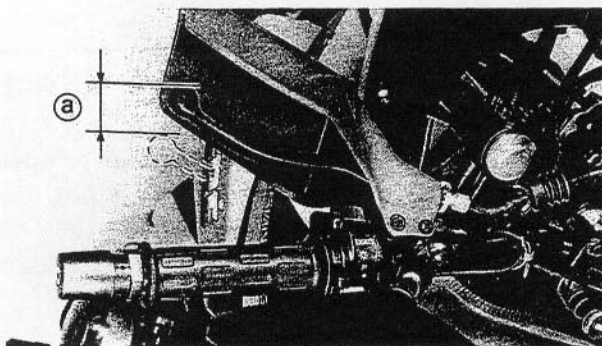

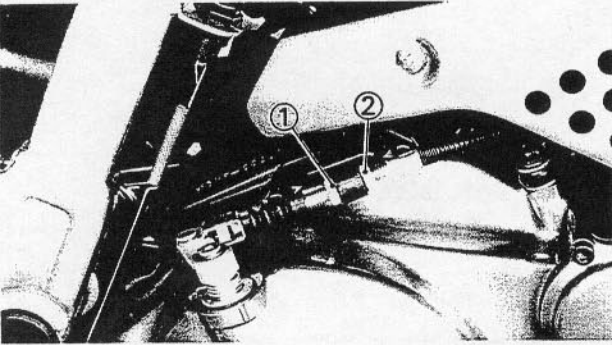

Turning in → Free play is increased.

Turning out → Free play is decreased.

- Tighten the locknut(s).

\*\*\*\*\*

## AIR FILTER CLEANING 37F 144510200

### 1. Remove:

- Seat
- Side cover (right)  
Refer to the "SEAT, FUEL TANK AND COVER" section.
- Air filter case cover ①

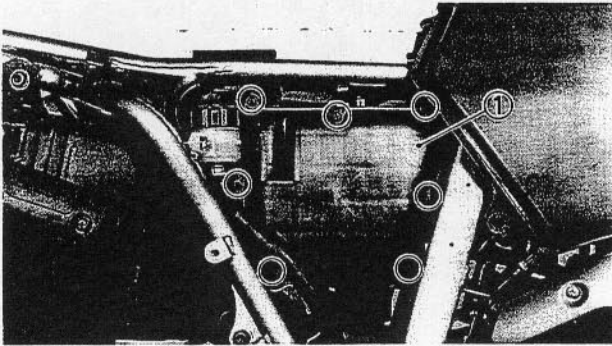

### 2. Remove:

- Air filter element ①

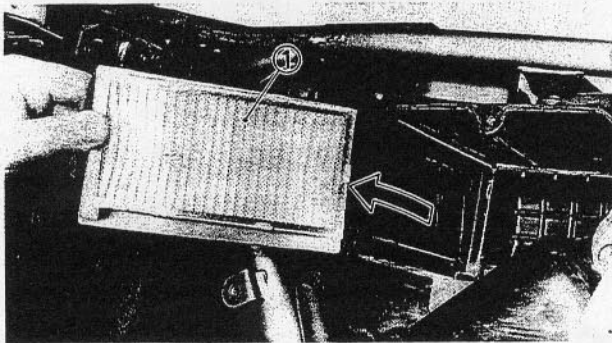

### CAUTION:

Never operate the engine with the air filter element removed. This will allow unfiltered air to enter, causing rapid wear and possible engine damage. Additionally, operation without the filter element will affect carburetor tuning with subsequent poor performance and possible engine overheating.

### 3. Inspect:

- Air filter element  
Damage → Replace.

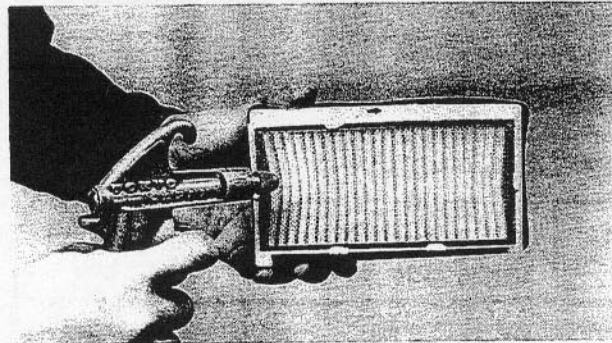

### 4. Clean:

- Air filter element  
Blow out dust in the element from the outer surface using compressed air.

### 5. Install:

- Air filter element

### NOTE:

- Install the air filter element with the arrow mark on the top pointing inward.
- When installing the air filter element in its case, fit section ① into the slot ② of air filter case.

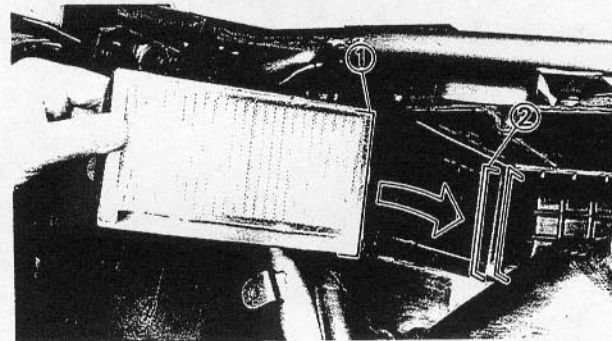



6. Install:

- Air filter case cover
- Side cover (right)
- Seat

	<b>Bolt (side cover):</b>
	7 Nm (0.7 m•kg, 5.1 ft•lb)
	<b>Bolt (seat):</b>
	10 Nm (1.0 m•kg, 7.2 ft•lb)

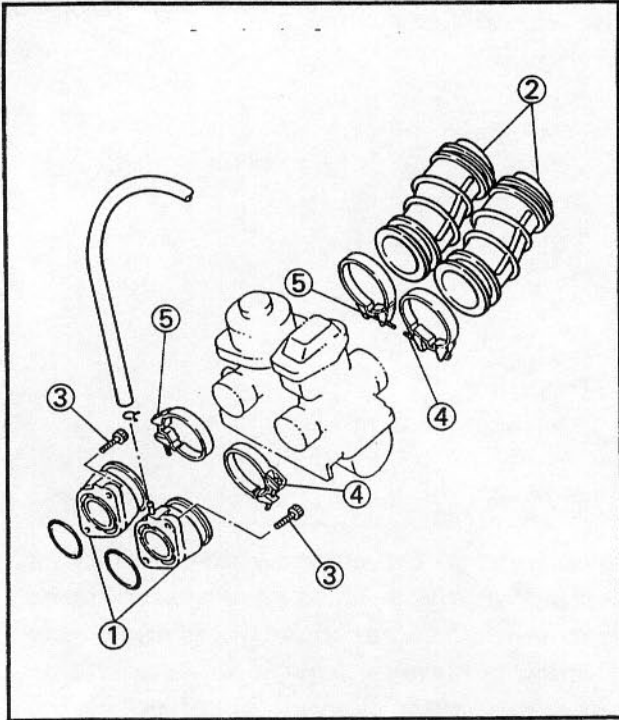

## CARBURETOR JOINT INSPECTION

1. Remove:

- Seat
- Side covers
- Air scoops
- Fuel tank

Refer to the "SEAT, FUEL TANK AND COVER" section.

2. Inspect:

- Carburetor joint ①, ②
- Crack/Damage → Replace.

	<b>Bolt ③ (carburetor joint):</b>
	10 Nm (1.0 m•kg, 7.2 ft•lb)
	<b>Screw ④ (left):</b>
	2 Nm (0.2 m•kg, 1.4 ft•lb)
	<b>Screw ⑤ (right):</b>
	5 Nm (0.5 m•kg, 3.6 ft•lb)

3. Install:

- Fuel tank
- Air scoops
- Side cover
- Seat

	<b>Bolts (fuel tank, cowling and fuel tank, side cover):</b>
	7 Nm (0.7 m•kg, 5.1 ft•lb)
	<b>Bolt (seat):</b>
	10 Nm (1.0 m•kg, 7.2 ft•lb)

# FUEL LINE INSPECTION / CRANKCASE VENTILATION HOSE INSPECTION



## FUEL LINE INSPECTION

### 1. Remove:

- Seat
- Side covers
- Air scoops
- Fuel tank

Refer to the "SEAT, FUEL TANK AND COVER" section.

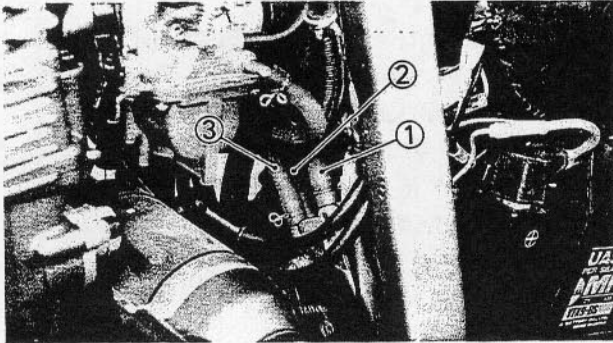

### 2. Inspect:

- Fuel hose ①
  - Vacuum hose ②
  - Delivery hose ③
- Crack/Damage → Replace.

### 3. Install:

- Air scoops
- Side covers
- Seat

	<b>Bolts (fuel tank, cowling and fuel tank, side cover):</b> 7 Nm (0.7 m•kg, 5.1 ft•lb)
	<b>Bolt (seat):</b> 10 Nm (1.0 m•kg, 7.2 ft•lb)

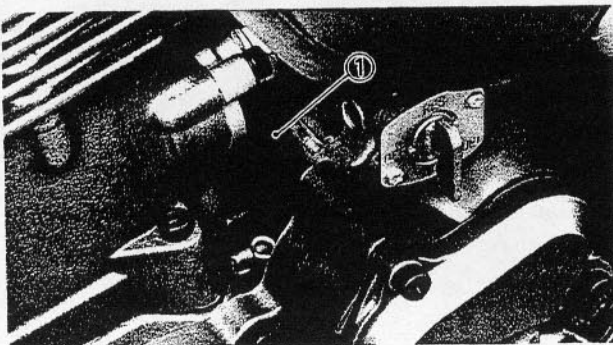

## CRANKCASE VENTILATION HOSE INSPECTION

### 1. Inspect:

- Crankcase ventilation hose ①
- Crack/Damage → Replace.

# EXHAUST SYSTEM INSPECTION/ COOLANT LEVEL INSPECTION

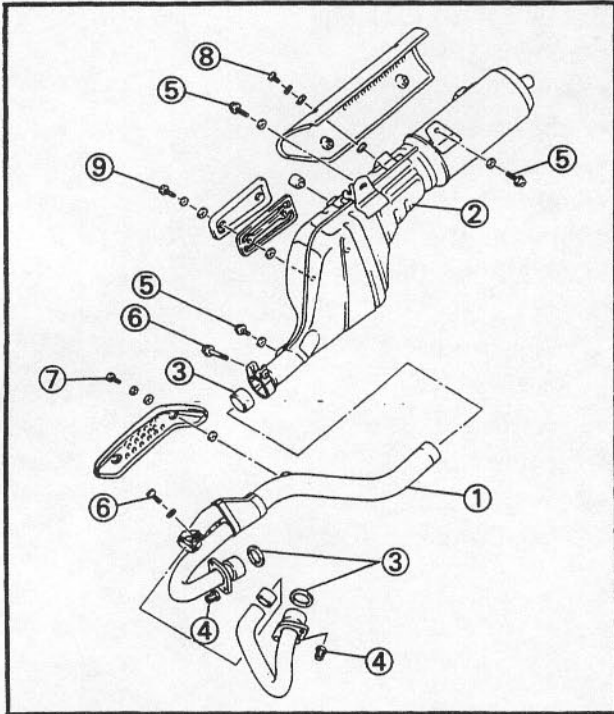

## EXHAUST SYSTEM INSPECTION

### 1. Inspect:

- Exhaust pipe ①
- Muffler ②  
Crack/Damage → Replace.
- Gasket ③  
Exhaust gas leaks → Replace.



### Nut ④ (exhaust pipe):

10 Nm (1.0 m•kg, 7.2 ft•lb)

### Bolt ⑤ (muffler):

40 Nm (4.0 m•kg, 29 ft•lb)

### Bolt ⑥ (clamp):

20 Nm (2.0 m•kg, 14 ft•lb)

### Screw ⑦ (protector):

7 Nm (0.7 m•kg, 5.1 ft•lb)

Use LOCTITE®.

### Screw ⑧ (protector):

7 Nm (0.7 m•kg, 5.1 ft•lb)

Use LOCTITE®.

### Screw ⑨ (protector):

7 Nm (0.7 m•kg, 5.1 ft•lb)

Use LOCTITE®.

YB2AD000

## COOLANT LEVEL INSPECTION

1. Place the motorcycle on a level place.

### NOTE:

Position the motorcycle straight up when inspecting the coolant level.

2. Remove:

- Air scoop (right)

3. Inspect:

- Coolant level

Coolant level should be between maximum ① and minimum ② marks.

Coolant level low → Add soft water (tap water) to proper level.

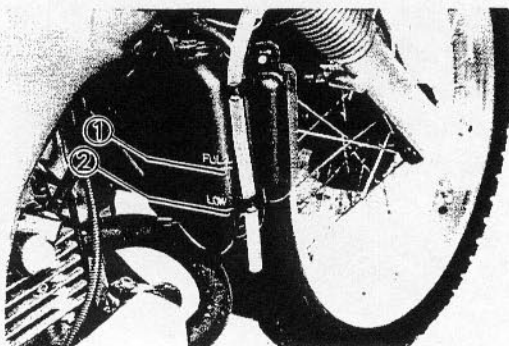



**CAUTION:**

Hard water or salt water is harmful to the engine parts; use boiled or distilled water if you can't get soft water.

4. Start the engine and let it warm up for several minutes.
5. Stop the engine and inspect the coolant level once again.

**NOTE:**

Wait a few minutes until level settles before inspecting the coolant level.

6. Install:
  - Air scoop (right)

YB2AD001

**COOLANT REPLACEMENT**

1. Remove:

- Seat
- Side covers
- Air scoops
- Fuel tank

Refer to the "SEAT, FUEL TANK AND COVER" section.

2. Remove:

- Engine guard ①

3. Place a drain pan under the reservoir tank and drain bolts.

4. Disconnect:

- Hose ① (reservoir tank)

Drain the reservoir tank of its coolant.

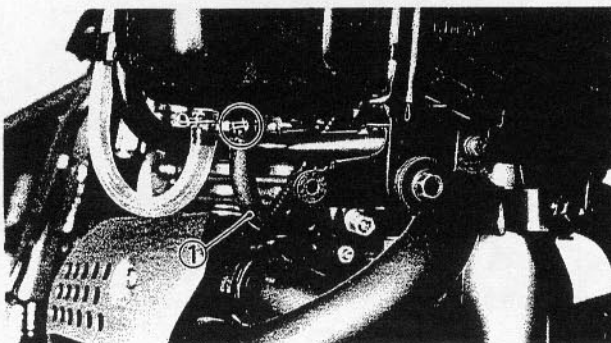
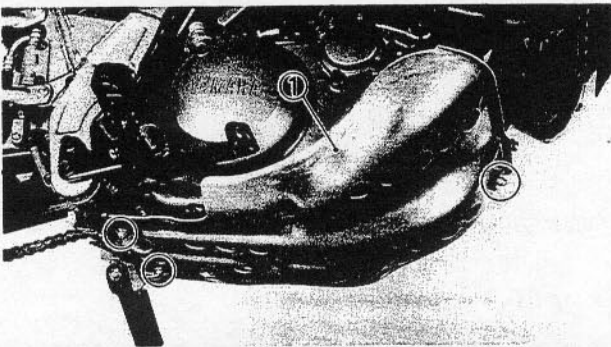

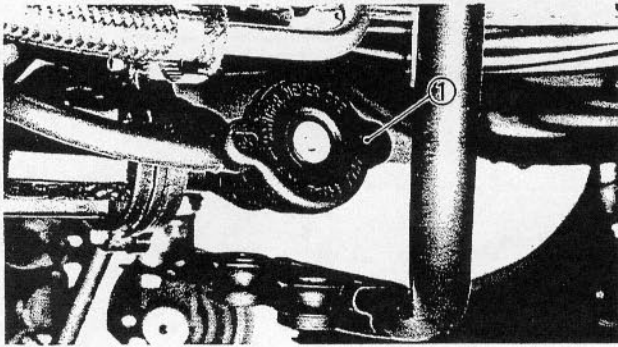

5. Remove:
- Radiator cap ①

**⚠ WARNING**

Do not remove the radiator cap when the engine and radiator are hot. Scalding hot fluid and steam may be blown out under pressure, which could cause serious injury. When the engine has cooled, open the radiator cap by the following procedure:

Place a thick rag, like a towel, over the radiator cap, slowly rotate the cap counterclockwise to the detente. This procedure allows any residual pressure to escape. When the hissing sound has stopped, press down on the cap while turning counterclockwise and remove it.

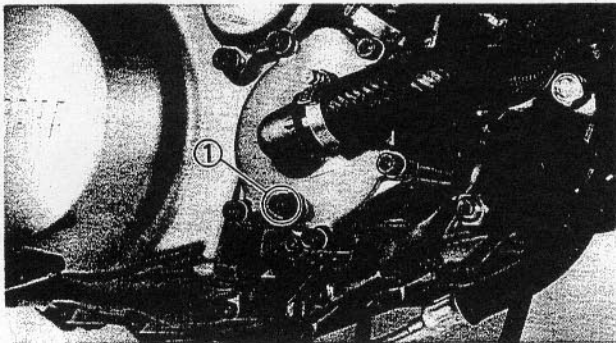

6. Remove:
- Drain bolt ① (water pump)
  - Gasket (drain bolt)
- Drain the radiator and engine of its coolant.

7. Inspect:
- Gasket (drain bolt)
- Damage → Replace.

8. Install:
- Gasket (drain bolt)
  - Drain bolt (water pump)
  - Engine guard

	<b>Drain bolt (water pump):</b>
	10 Nm (1.0 m•kg, 7.2 ft•lb)
	<b>Nut (engine guard):</b>
	7 Nm (0.7 m•kg, 5.1 ft•lb)
	<b>Bolt (engine guard):</b>
	7 Nm (0.7 m•kg, 5.1 ft•lb)

9. Connect:
- Hose (reservoir tank)

# COOLANT REPLACEMENT

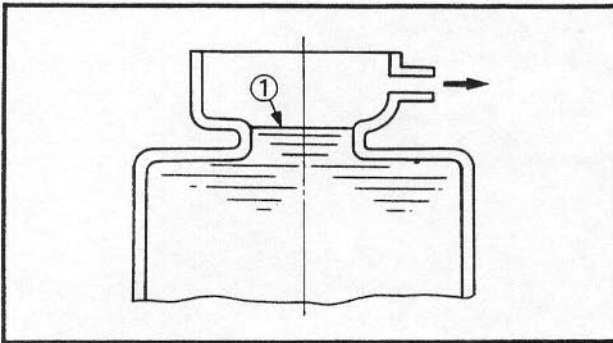
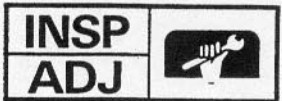

10. Fill:
- Radiator
  - Engine
- (to specified level ①)

 **Recommended coolant:**  
High quality ethylene glycol anti-freeze containing anti-corrosion for aluminum engine inhibitors

**Coolant and water (soft water)**  
**Mixed ratio: 50%/50%**  
**Total amount:**  
1.2 L (1.1 Imp qt, 1.3 US qt)  
**Reservoir tank capacity:**  
0.29 L (0.26 Imp qt, 0.31 US qt)

\*\*\*\*\*

### Handling notes of coolant:

- The coolant is harmful so it should be handled with special care.

### **⚠ WARNING**

- When coolant splashes in your eye. Thoroughly wash your eye with water and see your doctor.
- When coolant splashes on your clothes. Quickly wash it away with water and then with soap.
- When coolant is swallowed. Quickly make him vomit and take him to a doctor.

\*\*\*\*\*

### **CAUTION:**

- Hard water or salt water is harmful to the engine parts; use boiled or distilled water if you can't get soft water.
- Do not use water containing impurities or oil.
- Take care so that coolant does not splash on painted surfaces. If it splashes, wash it away with water.
- Do not mix more than one type of ethylene glycol anti-freeze containing corrosion inhibitors for aluminum engines.



11. Install:
- Radiator cap

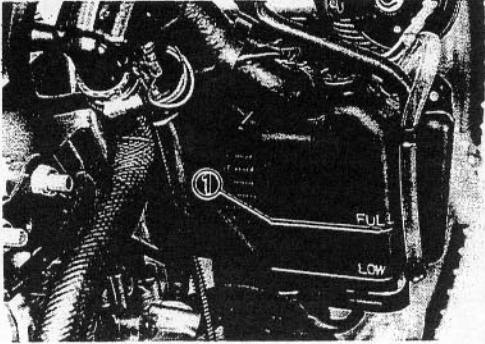

12. Fill:
- Reservoir tank  
(to maximum level ①)

13. Start the engine and let it warm up for several minutes.

14. Stop the engine and inspect the level.  
Refer to the "COOLANT LEVEL INSPECTION" section.

**NOTE:** \_\_\_\_\_  
Wait a few minutes until level settles before inspecting the coolant level.  
\_\_\_\_\_

15. Install:
- Fuel tank
  - Air scoops
  - Side covers
  - Seat



**Bolt (fuel tank, cowling and fuel tank, side cover):**

**7 Nm (0.7 m•kg, 5.1 ft•lb)**

**Bolt (seat):**

**10 Nm (1.0 m•kg, 7.2 ft•lb)**



YB2AD002

## COOLING SYSTEM INSPECTION

### 1. Inspect:

- Radiator ①
- Hose ② (thermostat—radiator)
- Hose ③ (radiator—water pump)
- Pipe ④ (water pump—cylinder)
- Hose ⑤ (cylinder head—thermostat housing)

Cracks/Damage → Replace.

Refer to the "COOLING SYSTEM" section in the CHAPTER 5.

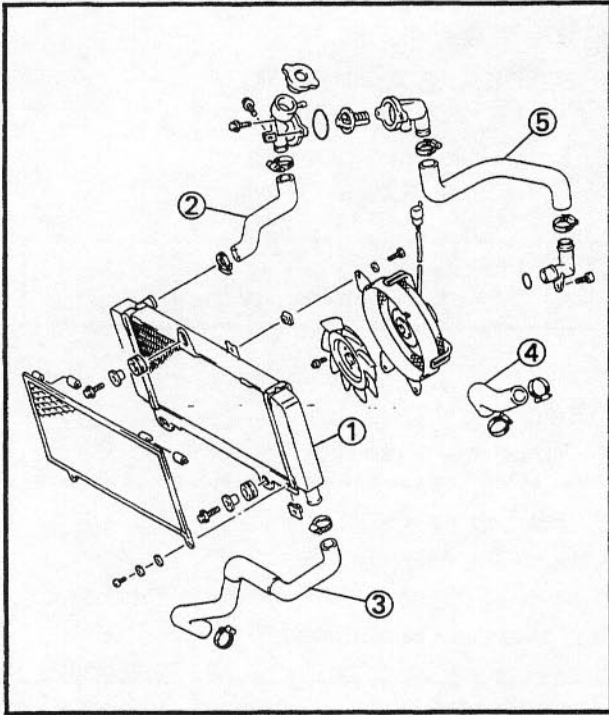

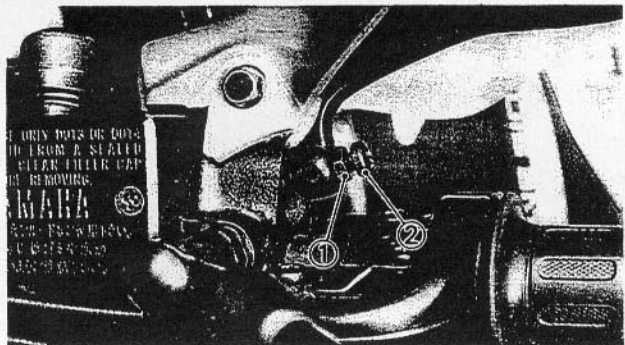
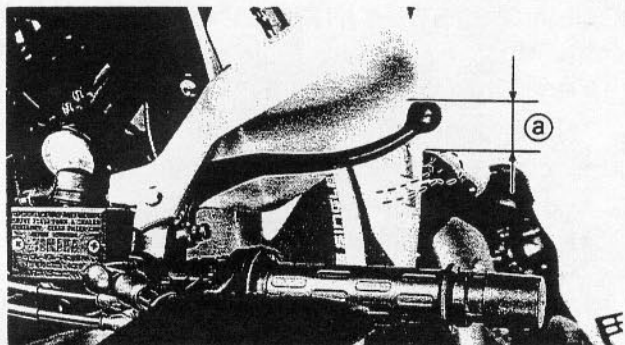

## CHASSIS

### FRONT BRAKE ADJUSTMENT

1. Check:
  - Brake lever free play (a)  
Out of specification → Adjust.



**Free play:**  
2~5 mm (0.08~0.20 in)

2. Adjust:
  - Brake lever free play

\*\*\*\*\*

#### Adjustment steps:

- Loosen the locknut (1).
- Turn the adjuster (2) in or out until the specified free play is obtained.

Turn in → Free play is decreased.

Turn out → Free play is increased.

- Tighten the locknut.

\*\*\*\*\*

#### CAUTION:

Proper lever free play is essential to avoid excessive brake drag.

#### ⚠ WARNING

A soft or spongy feeling in the brake lever can indicate the presence of air in the brake system. This air must be removed by bleeding the brake system before the motorcycle is operated. Air in the system will cause greatly diminished braking capability and can result in loss of control and an accident. Inspect and bleed the system if necessary.



# REAR BRAKE ADJUSTMENT

**INSP**  
**ADJ**



YB2A3004

## REAR BRAKE ADJUSTMENT

### 1. Check:

- Brake pedal height (a)  
Out of specification → Adjust.

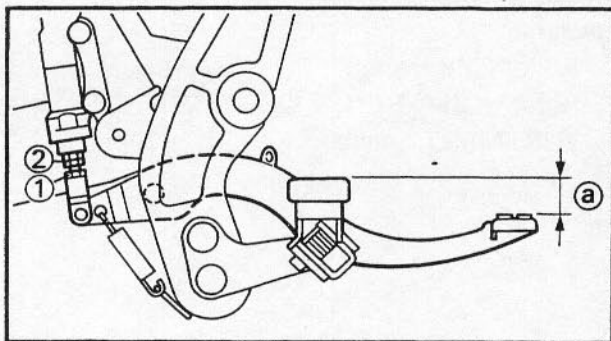

**Brake pedal height:**  
**25 mm (0.98 in)**  
**below top of footrest**

### 2. Adjust:

- Brake pedal height

\*\*\*\*\*

### Adjustment steps:

- Loosen the locknut (1).
- Turn the adjuster (2) in or out until the specified pedal height is obtained.

Turning in → Pedal height is increased.

Turning out → Pedal height is decreased.

### **⚠ WARNING**

After adjusting the brake pedal height, visually check the adjuster end. The adjuster end must appear within 4.0 mm (0.16 in).

- Tighten the locknut.



**Locknut:**  
**18 Nm (1.8 m•kg, 13 ft•lb)**

\*\*\*\*\*

### **CAUTION:**

Make sure that the brake does not drag after adjusting it.

### **⚠ WARNING**

A soft or spongy feeling in the brake pedal can indicate the presence of air in the brake system. This air must be removed by bleeding the brake system before the motorcycle is operated. Air in the system will cause greatly diminished braking capability and can result in loss of control and an accident. Inspect and bleed the system if necessary.

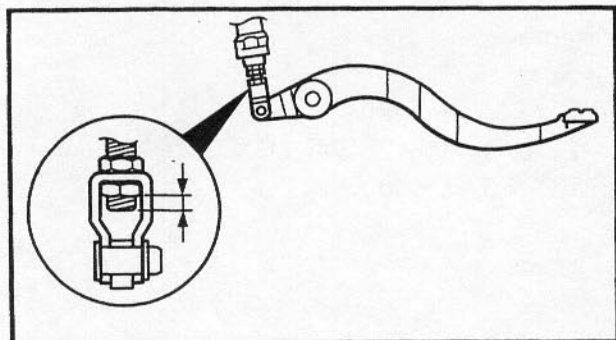

### 3. Adjust:

- Brake light switch

Refer to the "BRAKE LIGHT SWITCH ADJUSTMENT" section.

## BRAKE FLUID LEVEL INSPECTION

1. Place the motorcycle on a level place.

### NOTE:

- Position the motorcycle straight up when inspecting the brake fluid level.
- When inspecting the front brake fluid level, make sure the master cylinder top is horizontal by turning the handlebars.

### 2. Remove:

- Seat
- Side cover (right)

Refer to the "SEAT, FUEL TANK AND COVER" section.

### 3. Inspect:

- Brake fluid level

Fluid level is under "LOWER" level line

① → Fill up.

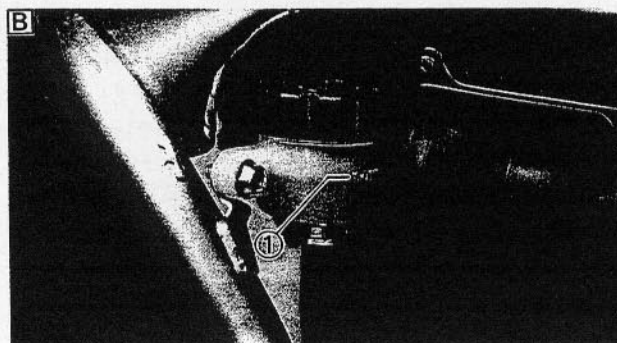
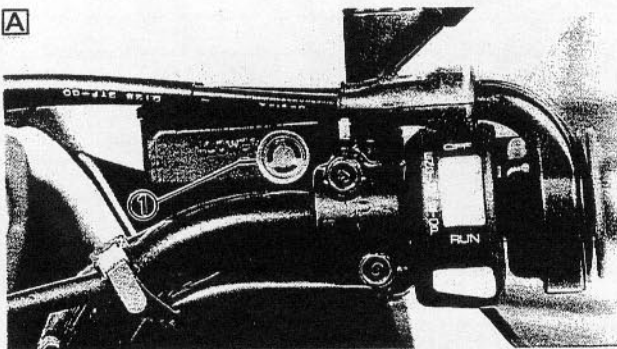

	<b>Recommended brake fluid:</b>
	Front: DOT No. 4
	Rear: DOT No. 4

**A** Front

**B** Rear

### CAUTION:

Brake fluid may erode painted surfaces or plastic parts. Always clean up spilled fluid immediately.



### ⚠ WARNING

- Use only the designated quality brake fluid; otherwise, the rubber seals may deteriorate, causing leakage and poor brake performance.
- Refill with the same type of brake fluid; mixing fluids may result in a harmful chemical reaction and lead to poor performance.
- Be careful that water does not enter the master cylinder when refilling. Water will significantly lower the boiling point of the fluid and may result in vapor lock.

#### 4. Install:

- Side cover (right)
- Seat



**Bolt (side cover (right)):**

7 Nm (0.7 m•kg, 5.1 ft•lb)

**Bolt (seat):**

10 Nm (1.0 m•kg, 7.2 ft•lb)

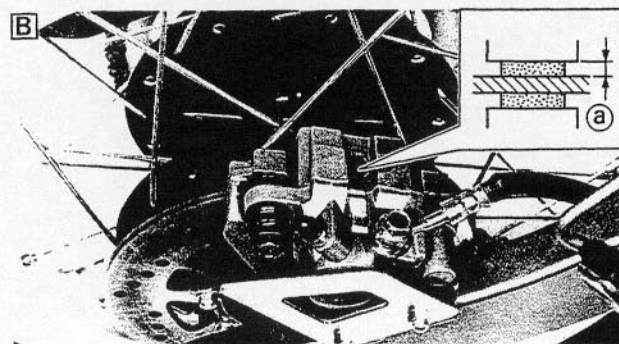
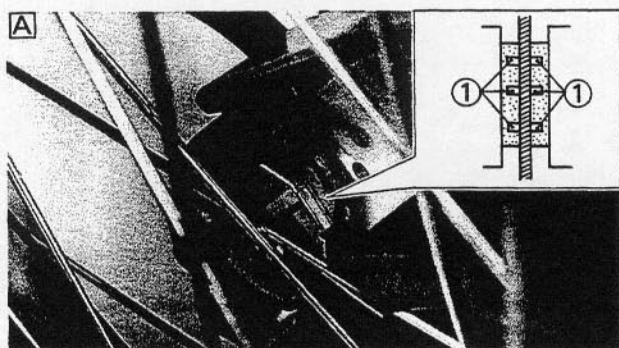

### BRAKE PAD INSPECTION

1. Activate the brake lever or brake pedal.
2. Inspect:
  - Brake pad (front)  
Wear indicator ① almost contacts brake disc → Replace brake pad as a set.
3. Check:
  - Pad thickness (rear)  
Out of specification → Replace.



**Wear limit:**

Front: 1.0 mm (0.04 in)

Rear ②: 0.8 mm (0.03 in)

Refer to the "BRAKE PAD REPLACEMENT" section in the CHAPTER 7.

- A** Front brake  
**B** Rear brake





## BRAKE LIGHT SWITCH ADJUSTMENT

### NOTE:

The brake light switch is operated by movement of the brake pedal.

Proper adjustment is achieved when the brake light comes on just before the brake begins to take effect.

#### 1. Check:

- Brake light operating timing  
Incorrect → Adjust.

#### 2. Adjust:

- Brake light operating timing

\*\*\*\*\*

#### Adjustment steps:

Hold the switch body ① with your hand so that it does not rotate and turn the adjusting nut ②.

\*\*\*\*\*

## BRAKE HOSE INSPECTION

#### 1. Inspect:

- Brake hose  
Crack/Damage → Replace.  
Refer to the "FRONT AND REAR BRAKE" section in the CHAPTER 7.

- A** Front
- B** Rear

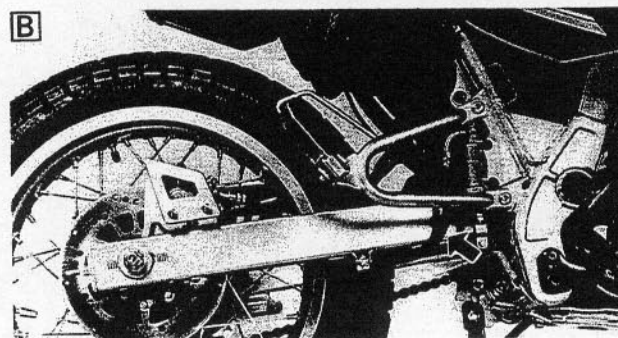
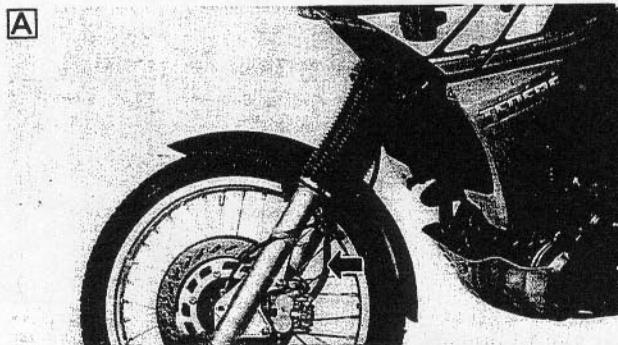
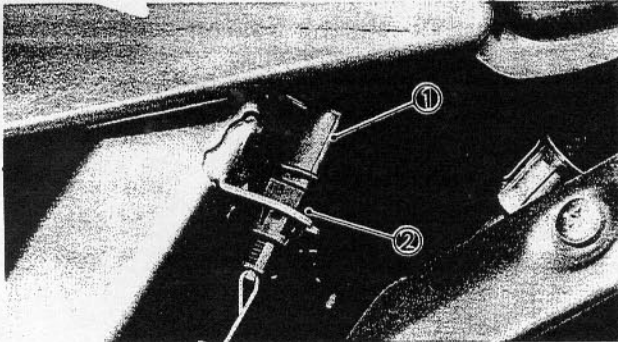

## AIR BLEEDING (HYDRAULIC BRAKE SYSTEM)

### **WARNING**

Bleed the brake system if:

- The system has been disassembled.
- A brake hose has been loosened or removed.
- The brake fluid is very low.
- The brake operation is faulty.

A dangerous loss of braking performance may occur if the brake system is not properly bled.

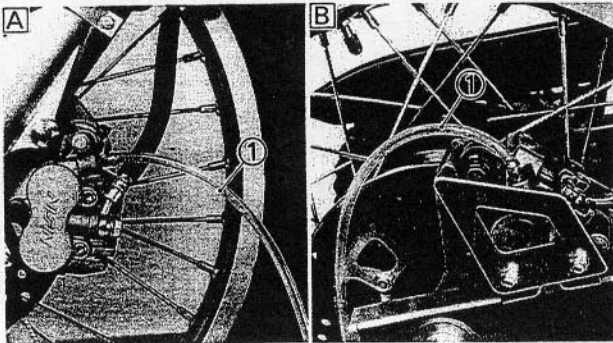

1. Bleed:
  - Brake system

\*\*\*\*\*

### Air bleeding steps:

- a. Add proper brake fluid to the reservoir.
- b. Install the diaphragm. Be careful not to spill any fluid or allow the reservoir to overflow.
- c. Connect the clear plastic tube ① tightly to the caliper bleed screw.

- A** Front  
**B** Rear

- d. Place the other end of the tube into a container.
- e. Slowly apply the brake lever or pedal several times.
- f. Pull the lever in or push down on the pedal. Hold the lever or pedal in position.
- g. Loosen the bleed screw and allow the lever or pedal to travel towards its limit.
- h. Tighten the bleed screw when the lever or pedal limit has been reached; then release the lever or pedal.

	<b>Bleed screw:</b> <b>6 Nm (0.6 m•kg, 4.3 ft•lb)</b>
---	--

- i. Repeat steps (e) to (h) until all of the air bubbles have been removed from the system.

# DRIVE CHAIN SLACK ADJUSTMENT



**NOTE:** \_\_\_\_\_

If the bleeding is difficult, it may be necessary to let the brake fluid system stabilize for a few hours. Repeat the bleeding procedure when the tiny bubbles in the system have disappeared.

---

j. Add brake fluid to proper level.

## **⚠ WARNING** \_\_\_\_\_

**Check the operation of the brake after bleeding brake system.**

---

\*\*\*\*\*

YB2A4008

# DRIVE CHAIN SLACK ADJUSTMENT

**NOTE:** \_\_\_\_\_

Before checking and/or adjusting, rotate the rear wheel several revolutions and check slack at several points to find the tightest point. Check and/or adjust the chain slack with the rear wheel in this "tightest" position.

---

## **CAUTION:** \_\_\_\_\_

**Too little of chain slack will overload the engine and other vital parts; keep the slack within the specified limits.**

---

## **⚠ WARNING** \_\_\_\_\_

**Securely support the motorcycle so there is no danger of it falling over.**

---

1. Place the motorcycle on a level place, and hold it in an upright position.

**NOTE:** \_\_\_\_\_

Both wheels should be on the ground without the rider on it.

---



# DRIVE CHAIN SLACK ADJUSTMENT

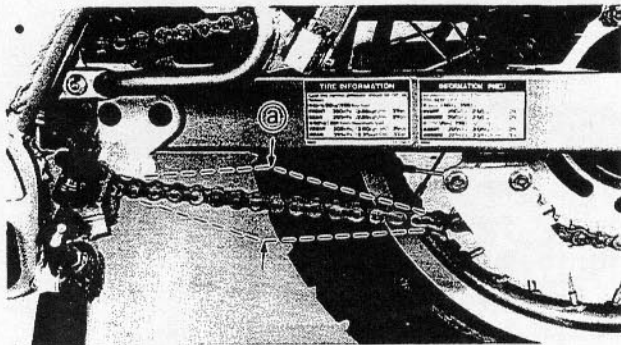

2. Check:
- Drive chain slack (a)
- Out of specification → Adjust.

 **Drive chain slack:**  
 20 ~ 45 mm (0.79 ~ 1.77 in)  
 at both wheels on ground  
 without rider

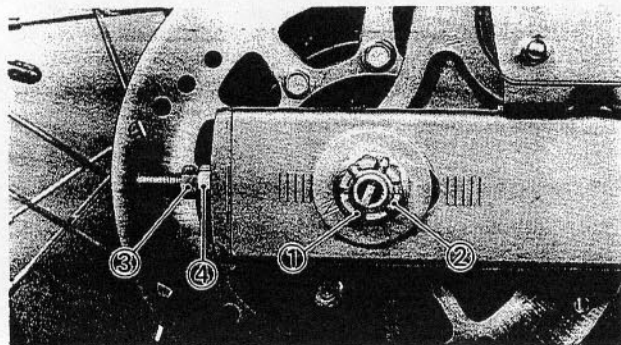

3. Adjust:
- Drive chain slack

\*\*\*\*\*

**Adjustment steps:**

- Remove the cotter pin (1) and loosen the axle nut (2).
- Loosen the locknut (3).
- Turn the adjuster (4) in or out until the specified slack is obtained.

Turning in → Slack is increased.  
 Turning out → Slack is decreased.

**NOTE:** \_\_\_\_\_

Turn each adjuster exactly the same amount to maintain correct axle alignment. (There are marks on each side of swingarm and on each chain puller; use them to check for proper alignment.)

- Tighten the axle nut to specification, while pushing up or down on the chain to zero slack.

 **Axle nut:**  
 100 Nm (10.0 m•kg, 72 ft•lb)

- Tighten the locknut.

 **Locknut:**  
 15 Nm (1.5 m•kg, 11 ft•lb)

\*\*\*\*\*

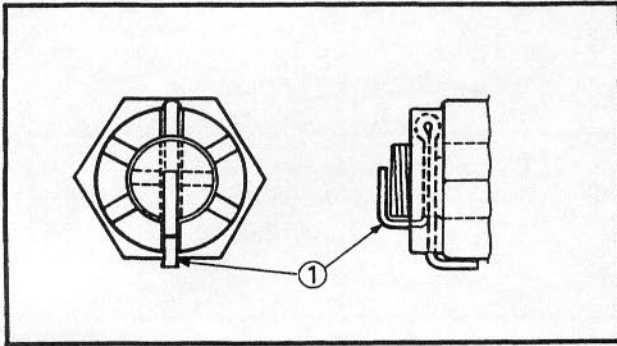

4. Install:
- Cotter pin ①

**CAUTION:**

Do not loosen the axle nut after torque tightening. If the axle nut groove is not aligned with the cotter pin hole, align groove with the hole by tightening up on the axle nut.

**⚠ WARNING**

Always use a new cotter pin.

YB2A4025

## DRIVE CHAIN LUBRICATION

The chain consists of many parts which work against each other. If the chain is not maintained properly, it will wear out rapidly, therefore, form the habit of periodically servicing the chain. This service is especially necessary when riding in dusty conditions.

This motorcycle has a drive chain with small rubber O-rings between the chain plates.

Steam cleaning, high-pressure washes, and certain solvents can damage these O-rings. Use only kerosene to clean the drive chain. Wipe it dry, and thoroughly lubricate it with SAE 30~50W motor oil. Do not use any other lubricants on the drive chain. They may contain solvents that could damage the O-rings ①.

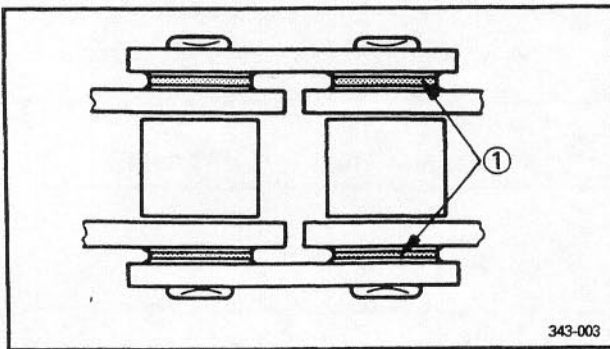

343-003



**Recommended lubricant:**  
SAE 30~50W Motor Oil



YB3A1000

## STEERING HEAD ADJUSTMENT

### **⚠ WARNING**

Securely support the motorcycle so there is no danger of it falling over.

1. Place the motorcycle on a level place.
2. Elevate the front wheel by placing a suitable stand under the frame and engine.

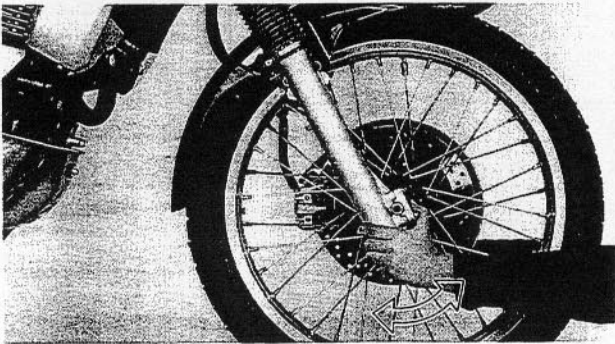

3. Check:
  - Steering assembly bearings  
Grasp the bottom of the forks and gently rock the fork assembly back and forth.  
Looseness → Adjust steering head.
4. Remove:
  - Seat
  - Side covers
  - Air scoops
  - Fuel tank
5. Adjust:
  - Steering head



# STEERING HEAD ADJUSTMENT

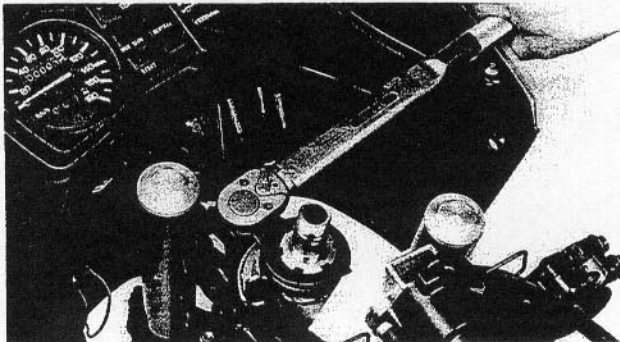
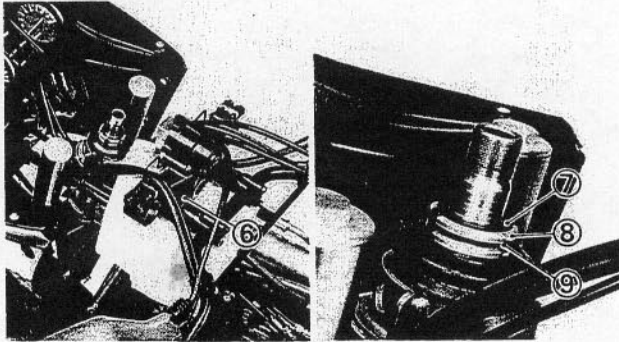
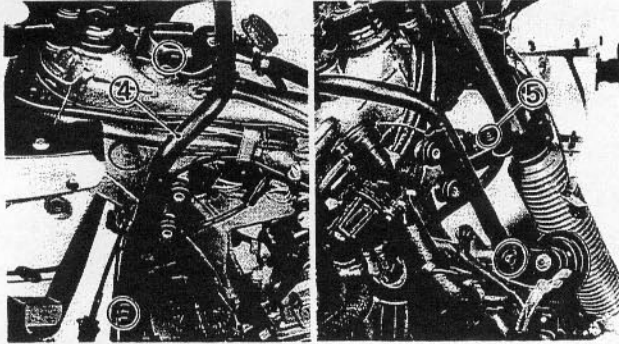
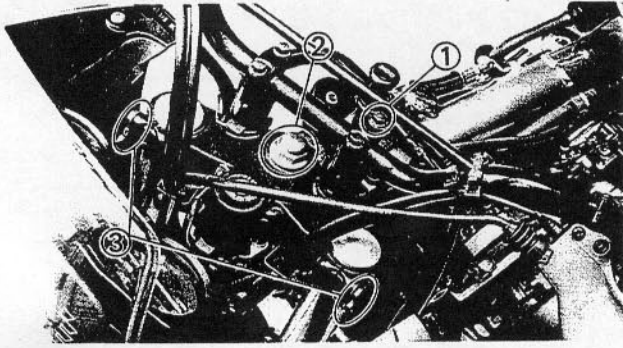

\*\*\*\*\*

## Adjustment steps:

- Remove the bolt ① ("CHOKE" knob assembly).
- Remove the nut ② (steering shaft) and loosen the bolt ③ (handlebar crown).
- Remove the fuel tank stay ④ and bolt (brake hose guide) ⑤.
- Put the rag around on the oil tank cap.
- Remove the handlebar crown ⑥ (with the handlebar) on the rug.
- Remove the stopper washer ⑦, second ring nut ⑧ and rubber washer. ⑨.
- Tighten the ring nut (lower) using the ring nut wrench.

## NOTE: \_\_\_\_\_

Set the torque wrench to the ring nut wrench so that they form a right angle.

\_\_\_\_\_



**Ring nut wrench:**  
P/N. YU-33975  
P/N. 90890-01403



**Ring nut (lower) (initial tightening):**  
43 Nm (4.3 m•kg, 31 ft•lb)

- Reset the handlebar crown (with the handlebar) on the front fork.
- Turn the handlebar to the left and right making sure there is no binding and then fully loosen the ring nut.
- Retighten the ring nut using the ring nut wrench.

## ⚠ WARNING \_\_\_\_\_

**Avoid over-tightening.**

\_\_\_\_\_



**Ring nut (final tightening):**  
**7 Nm (0.7 m•kg, 5.1 ft•lb)**

**NOTE:** \_\_\_\_\_

Recheck the steering head by turning the steering from lock to lock, after adjusting steering head.

If steering is binded, loosen the ring nut but not to the extent of free play in bearing.

If steering is loosened, repeat the adjustment steps.

- Install the rubber washer on the ring nut (lower); then finger tighten the ring nut (upper) until it contacts the rubber washer. Align the grooves of the lower and upper nuts and install the stopper washer.
- Tighten the nut (steering shaft) and bolt (handlebar crown).



**Nut (steering shaft):**  
**110 Nm (11 m•kg, 80 ft•lb)**  
**Bolt (handlebar crown):**  
**23 Nm (2.3 m•kg, 17 ft•lb)**

- Tighten the bolt (brake hose guide), temporary tighten the bolt (fuel tank stay) and tighten the bolt ("CHOKE" knob assembly).



**Bolt (brake hose guide):**  
**7 Nm (0.7 m•kg, 5.1 ft•lb)**  
**Bolt ("CHOKE" knob assembly):**  
**23 Nm (2.3 m•kg, 17 ft•lb)**

\*\*\*\*\*

6. Install:
  - Fuel tank
7. Tighten:
  - Bolt (fuel tank stay)
  - Air scoops
  - Side covers
  - Seat



**Bolt (fuel tank, cowling and fuel tank, side cover):**  
**7 Nm (0.7 m•kg, 5.1 ft•lb)**  
**Bolt (fuel tank stay):**  
**15 Nm (1.5 m•kg, 11 ft•lb)**  
**Bolt (seat):**  
**10 Nm (0.7 m•kg, 7.2 ft•lb)**

# FRONT FORK INSPECTION/ REAR SHOCK ABSORBER ADJUSTMENT

INSP  
ADJ



YB2A1001

## FRONT FORK INSPECTION

### **⚠ WARNING**

Securely support the motorcycle so there is no danger of it falling over.

1. Place the motorcycle on a level place.
2. Check:
  - Inner tube  
Scratch/Damage → Replace.
  - Oil seal  
Excessive oil leakage → Replace.
3. Hold the motorcycle on upright position and apply the front brake.

4. Check:
  - Operation  
Pump the front fork up and down for several times.  
Unsmooth operation → Repair.  
Refer to the "FRONT FORK" section in the CHAPTER 7.

YB2A2002

## REAR SHOCK ABSORBER ADJUSTMENT

### **⚠ WARNING**

Securely support the motorcycle so there is no danger of it falling over.

1. Adjust:
  - Spring preload
  - Damping

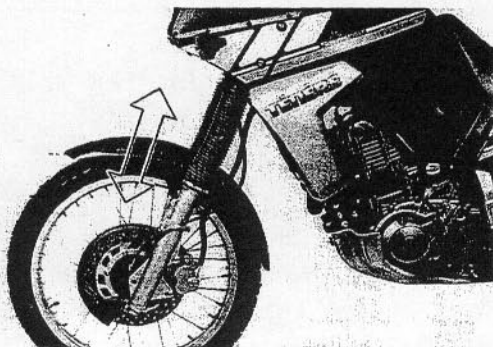
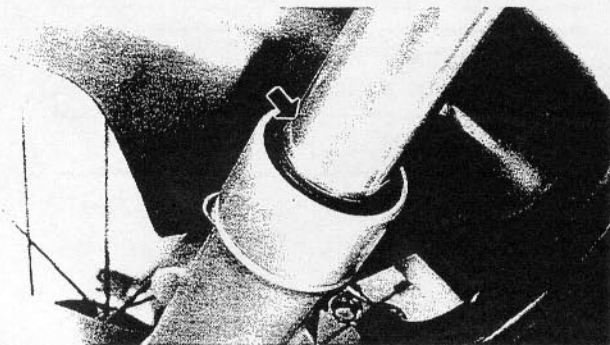



# REAR SHOCK ABSORBER ADJUSTMENT

**INSP**  
**ADJ**



\*\*\*\*\*

## Adjustment steps:

### Spring preload

- Loosen the locknut ① using the ring nut wrench.



**Ring nut wrench:**  
P/N. YM-38520  
P/N. 90890-01443

- Turn the adjuster ② in or out.

**Turning in → Spring preload is increased.**

**Turning out → Spring preload is decreased.**

### NOTE:

The length of the spring (installed) changes 1.0 mm (0.04 in) per turn of the adjuster.

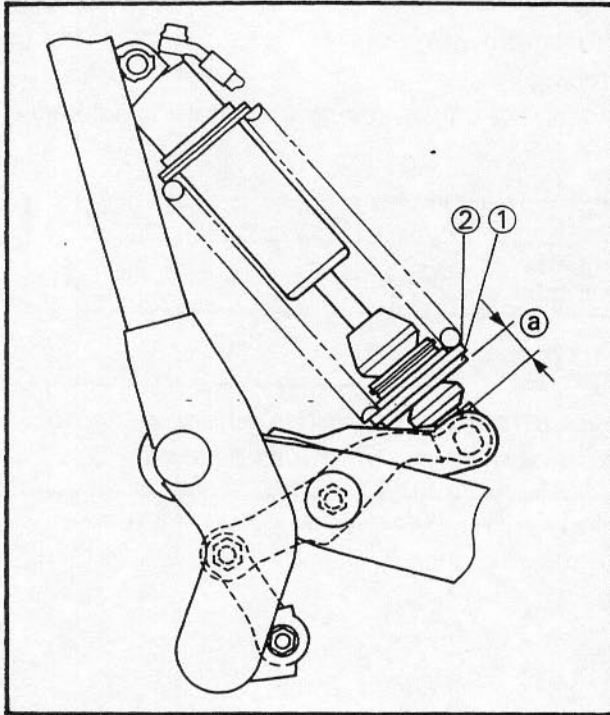

### Measurement length ①:

#### Standard:

25.5 mm (1.0 in)

#### Minimum:

22.5 mm (0.89 in)

#### Maximum:

32.5 mm (1.28 in)

### CAUTION:

Never attempt to turn the adjuster beyond the maximum or minimum setting.

- Tighten the locknut.



**Locknut:**  
42 Nm (4.2 m•kg, 30 ft•lb)

### CAUTION:

Always tighten the locknut against the spring adjuster and torque the locknut to specification.

\*\*\*\*\*

# TIRE INSPECTION

<b>INSP</b>	
<b>ADJ</b>	

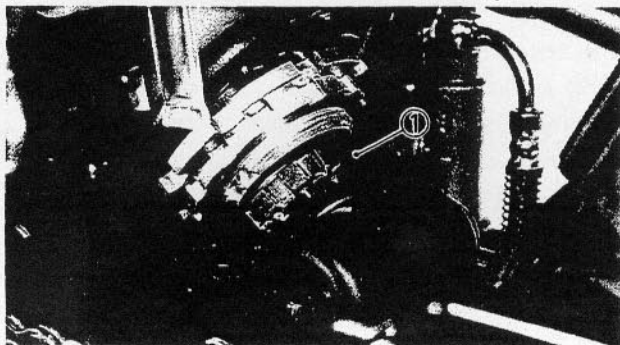

\*\*\*\*\*

## Adjustment steps:

### Damping

- Adjust the damping with the damping adjuster ①.

	Hard			S.T.D.	Soft
Adjuster position	5	4	3	2	1

### CAUTION:

Never attempt to turn the adjuster beyond the maximum or minimum setting.

\*\*\*\*\*

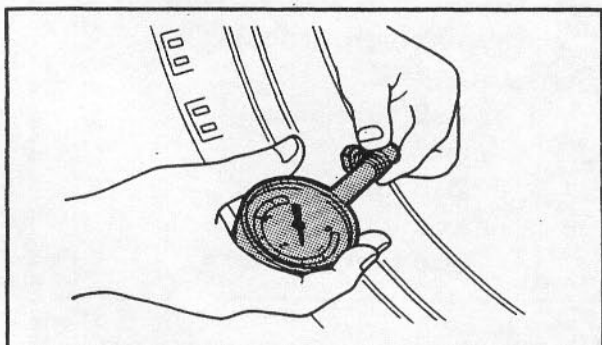

YB2A3014

## TIRE INSPECTION

### 1. Measure:

- Tire pressure
- Out of specification → Adjust.

### ⚠ WARNING

- Tire inflation pressure should be checked and adjusted when the temperature of the tire equals the ambient air temperature. Tire inflation pressure must be adjusted according to total weight of cargo, rider, passenger, and accessories (fairing, saddlebags, etc. if approved for this model), and vehicle speed.
- Proper loading of your motorcycle is important for the handling, braking, and other performance and safety characteristics of your motorcycle. Do not carry loosely packed items that can shift. Securely pack your heaviest items close to the center of the motorcycle, and distribute the weight evenly from side to side. Properly adjust the suspension for your load, and check the condition and pressure of your tires. **NEVER OVERLOAD YOUR MOTORCYCLE.** Make sure the total weight of the cargo, rider, passenger, and accessories (fairing, saddlebags, etc. if approved for this model) does



not exceed the maximum load of the motorcycle. Operation of an overloaded motorcycle could cause tire damage, an accident, or even injury.

<b>Basic weight:</b> With oil and full fuel tank	195 kg (430 lb)
<b>Maximum load*</b>	180 kg (397 lb)

Cold tire pressure	Front	Rear
Up to 90 kg (198 lb) load*	200 kPa (2.00 kg/cm <sup>2</sup> , 28 psi)	200 kPa (2.00 kg/cm <sup>2</sup> , 28 psi)
90 kg (198 lb) ~ Maximum load*	200 kPa (2.00 kg/cm <sup>2</sup> , 28 psi)	225 kPa (2.25 kg/cm <sup>2</sup> , 32 psi)

\*Load is the total weight of cargo, rider, passenger, and accessories.

2. Inspect:

- Tire surfaces  
Wear/Damage → Replace.

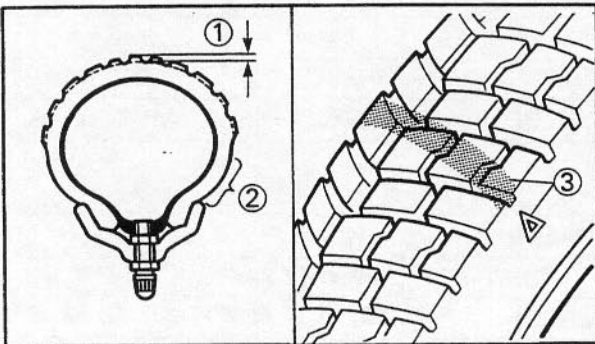

**Minimum tire tread depth  
(front and rear):  
0.8 mm (0.03 in)**

- ① Tread depth
- ② Side wall
- ③ Wear indicator

**⚠ WARNING**

- It is dangerous to ride with a wornout tire. When a tire tread begins to show lines, replace the tire immediately.
- Patching a punctured tube is not recommended. If it is absolutely necessary to do so, use great care and replace the tube as soon as possible with a good quality replacement.
- Do not attempt to use tubeless tires on a wheel designed for tube type tires only. Tire failure and personal injury may result from sudden deflation.



Tube type wheel → Tube type tire only
Tubeless type wheel → Tube type or tubeless tire

- Be sure to install the correct tube when using tube type tires.
- After extensive tests, the tires mentioned below have been approved by Yamaha motor Co., Ltd. for this model. No guarantee for handling characteristics can be given if tire combinations other than what is approved are used on this motorcycle. The front and rear tires should be of the same manufacture and design.

**Front:**

Manufacture	Size	Type
BRIDGESTONE	90/90-21 54S	TW41
DUNLOP	90/90-21 54S	TRAIL MAX G

**Rear:**

Manufacture	Size	Type
BRIDGESTONE	120/90-17 64S	TW42B
DUNLOP	120/90-17 64S	TRAIL MAX G

**⚠ WARNING**

- After mounting a tire, ride conservatively to allow proper tire to rim seating. Failure to do so may cause an accident resulting in motorcycle damage and possible operator injury.
- After a tire repair or replacement, be sure to torque tighten the valve stem locknut ① to specification.

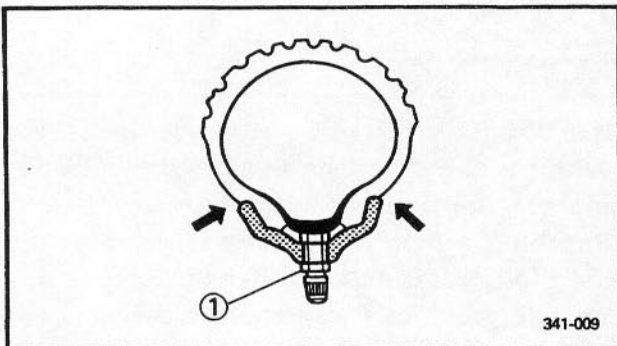

	<b>Valve stem locknut:</b> <b>1.5 Nm (0.15 m•kg, 1.1 ft•lb)</b>
---	--

# WHEEL INSPECTION/ SPOKE INSPECTION AND TIGHTENING



YB2A3016

## WHEEL INSPECTION

1. Inspect:

- Wheels

Damage/Bends → Replace.

**NOTE:** \_\_\_\_\_

Always balance the wheel when a tire or wheel has been changed or replaced.

---

**⚠ WARNING** \_\_\_\_\_

Never attempt even small repairs to the wheel.

---

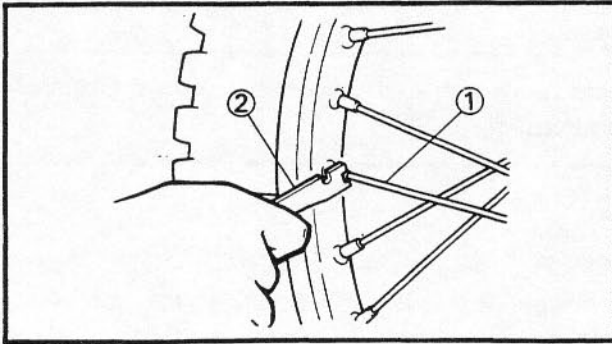

YB2A3017

## SPOKES INSPECTION AND TIGHTENING

1. Inspect:

- Spokes ①

Bend/Damage → Replace.

Loose spoke → Retighten.

2. Tighten:

- Spokes

② Spoke wrench

**NOTE:** \_\_\_\_\_

Be sure to retighten these spokes before and after Break-in.

---



**Nipple:**

**1.5 Nm (0.15 m•kg, 1.1 ft•lb)**



YB3A3018

**CABLE INSPECTION AND LUBRICATION**

**⚠ WARNING**

Damaged cable sheath may cause corrosion and interfere with the cable movement. An unsafe condition may result so replace such cable as soon as possible.

1. Inspect:
  - Cable sheath  
Damage → Replace.
2. Check:
  - Cable operation  
Unsmooth operation → Lubricate.



**Recommended lubricant:  
SAE 10W30 motor oil**

**NOTE:**

Hold cable end high and apply several drops of lubricant to cable.

YB3A3019

**LEVER AND PEDAL LUBRICATION**

Lubricate the lever and pedal at their pivoting points.



**Recommended lubricant:  
SAE 10W30 motor oil**

YB3A5000

**SIDESTAND LUBRICATION**

Lubricate the sidestand at pivoting points.



**Recommended lubricant:  
SAE 10W30 motor oil**



# REAR SUSPENSION LUBRICATION

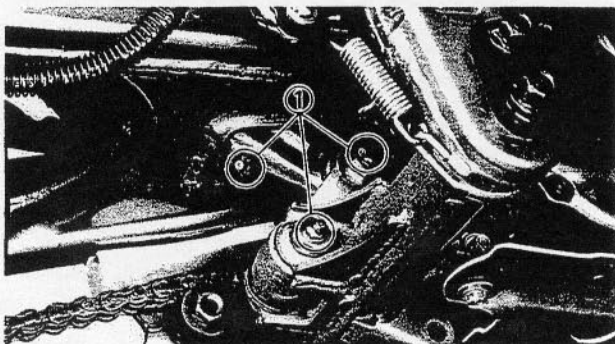

YB2A2005

## REAR SUSPENSION LUBRICATION

Lubricate the swingarm and relay arms at their pivoting points.



**Recommended lubricant:**  
**Lithium soap base grease**

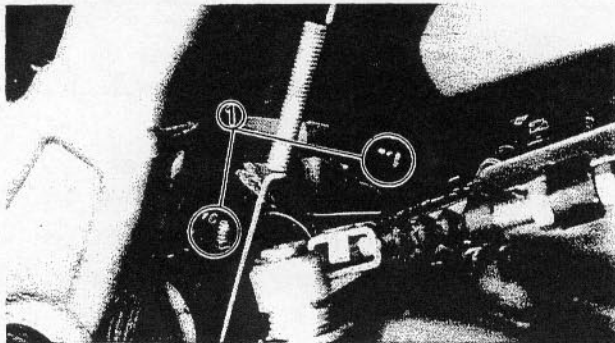

① Grease nipple

## ELECTRICAL

### BATTERY INSPECTION

#### NOTE:

Since the MF battery is of a sealed-type construction, it is impossible to measure the specific gravity of the electrolyte in order to check the state of charge in the battery. Therefore, to check the state of charge in the battery, voltage must be measured at the battery terminals.

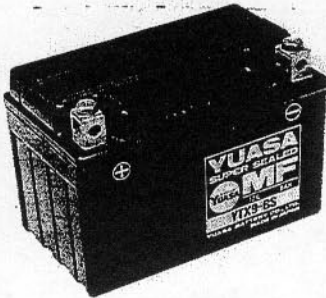

#### CAUTION:

### CHARGING METHOD

- This battery is sealed type. Never remove sealing caps even when charging. With the sealing cap removed, this balancing will not be maintained, and battery performance will lower gradually.
- Never add water. If distilled water is added, chemical reaction in the battery will not proceed in the normal way, thus making it impossible for the battery to operate regularly.
- The charging time, charging current and charging voltage for the MF battery is different than general type batteries. The MF battery should be charged as instructed in the "Charging method". Should the battery be overcharged, the electrolyte level will lower extremely. Therefore, use special care when charging the battery.
- Avoid using any electrolyte other than specified. The specific gravity of the MF battery electrolyte is 1.32 at 20°C (68°F). (The specific gravity of the general type battery electrolyte is 1.28.) If the electrolyte whose specific gravity is less than 1.32, the sulfuric acid will decrease and thus low battery performance will result. Should any electrolyte, whose specific gravity is 1.32 or more, be used, the battery plates will corrode and battery life will shorten.



## ⚠ WARNING

Battery electrolyte is dangerous; it contains sulfuric acid and therefore is poisonous and highly caustic.

Always follow these preventive measures:

- Avoid bodily contact with electrolyte as it can cause severe burns or permanent eye injury.
- Wear protective eye gear when handling or working near batteries.

Antidote (EXTERNAL):

- SKIN-Flush with water.
- EYES-Flush with water for 15 minutes and get immediate medical attention.

Antidote (INTERNAL):

- Drink large quantities of water or milk follow with milk of magnesia, beaten egg, or vegetable oil. Get immediate medical attention.

Batteries also generate explosive hydrogen gas, therefore you should always follow these preventive measures:

- Charge batteries in a well-ventilated area.
- Keep batteries away from fire, sparks, or open flames (e.g., welding equipment, lighted cigarettes, etc.)
- **DO NOT SMOKE** when charging or handling batteries.

**KEEP BATTERIES AND ELECTROLYTE OUT OF REACH OF CHILDREN.**

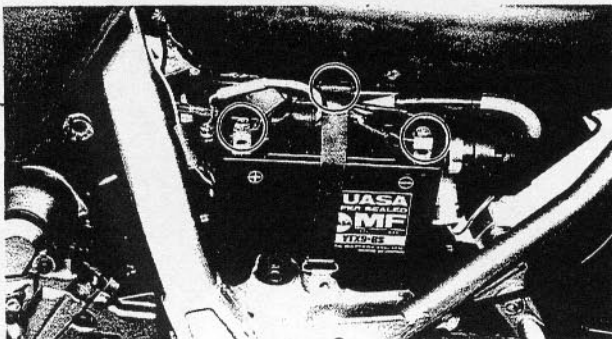
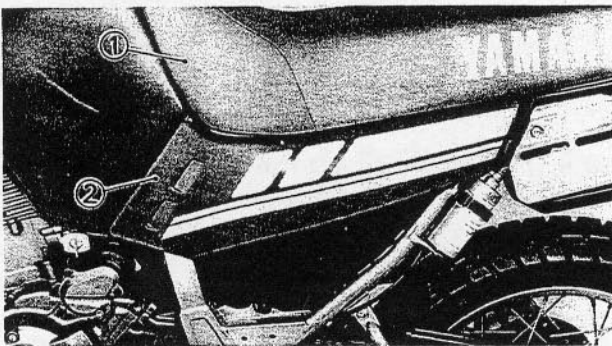

1. Remove:

- Seat ①
- Side cover ② (left)

Refer to the "SEAT, FUEL TANK AND COVER" section.

2. Disconnect:

- Battery leads

## CAUTION:

Disconnect the negative lead first and then disconnect the positive lead.

3. Remove:

- Battery



# BATTERY INSPECTION

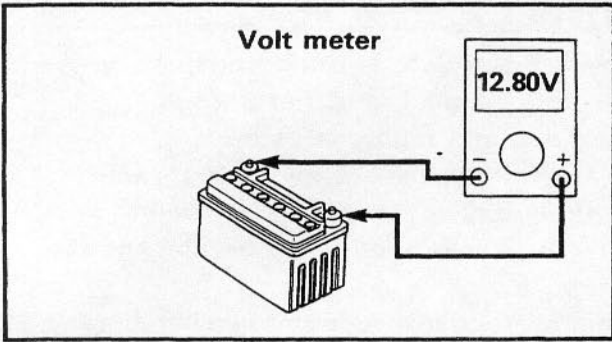

4. Check:
- Battery condition

\*\*\*\*\*

### Battery condition checking steps:

- Connect a digital volt meter to the battery terminals.

Tester (+) lead → Battery (+) terminal.  
 Tester (-) lead → Battery (-) terminal.

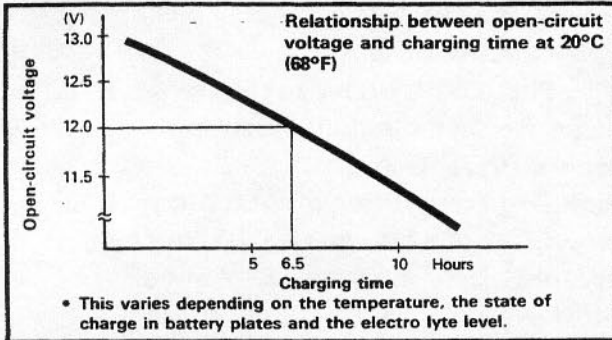

### NOTE: \_\_\_\_\_

The state of a discharged MF battery can be checked by measuring open circuit voltage (the voltage measured with the positive terminals being disconnected).

Open-circuit voltage	Charging time
12.8V or more	No charging is necessary.

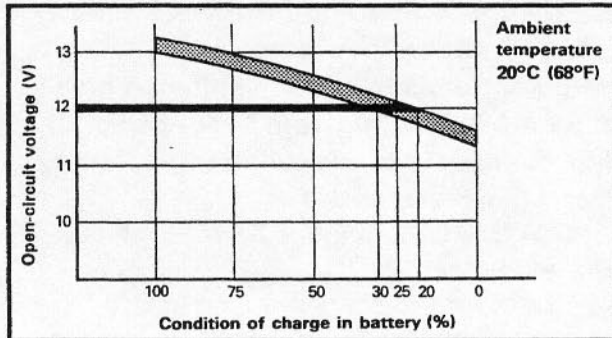

- Check the battery condition using figure.

Example:

Open circuit voltage = 12.0V

Charging time = 6.5 hours

Condition of charge in battery = 20 ~ 30%

\*\*\*\*\*

### 5. Charging method of MF battery.

#### CAUTION: \_\_\_\_\_

- If it is impossible to set the standard charging current, this type of battery charger cannot charge the MF battery.
- When charging the battery, be sure to remove it from the machine. (If charging has to be done with the battery mounted on the machine for some reason, be sure to disconnect the wire at the negative terminal.)
- Never remove the sealing plug from the MF battery.

# BATTERY INSPECTION

INSP  
ADJ

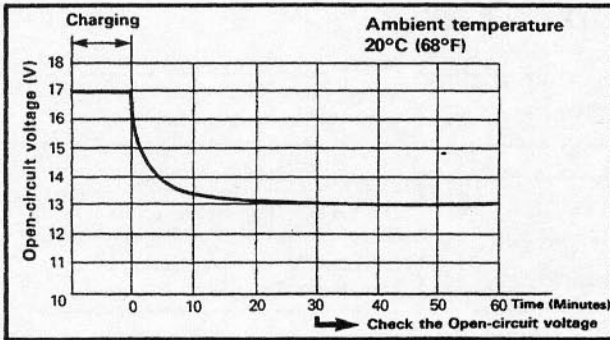

- Use special care so that charging clips are in a full contact with the terminal and that they are not shorted. (A corroded clip of the charger may cause the battery to generate heat at the contact area. A weak clip spring may cause sparks.)
- Before removing the clips from the battery terminals, be sure to turn off the power switch of the charger.
- Change in the open-circuit voltage of the MF battery after being charged is shown below. As shown in the figure, the open-circuit voltage is stabilized 30 minutes after charging has been completed. Therefore, to check the condition of the battery, measure the open-circuit voltage 30 minutes after charging has been completed.

# BATTERY INSPECTION

INSP  
ADJ



## Charging method using a variable-current (voltage) type charger

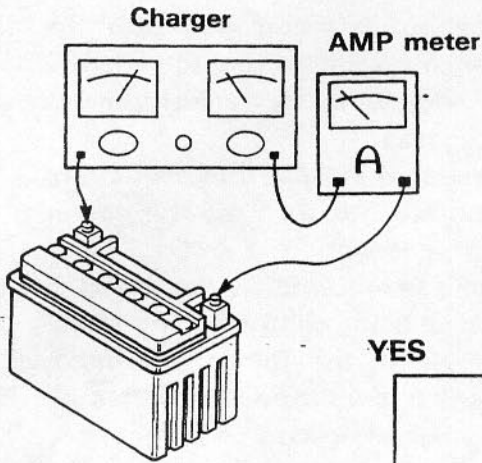

Measure the open-circuit voltage prior to charging.

**NOTE:** \_\_\_\_\_  
Voltage should be measured 30 minutes after the machine is stopped.

Connect a charger and AMP meter to the battery and start charging.

**NOTE:** \_\_\_\_\_  
Set the changing voltage at 16~17V. (If the setting is lower, charging will be insufficient. If too high, the battery will be over-charged.)

Make sure the current is higher than the standard charging current written on the battery.

YES

NO

By turning the charging voltage adjust dial, set the charging voltage at 20~25V.

Adjust the voltage so that current is at standard charging level.

YES

Monitor the amperage for 3~5 minutes to check if the standard charging current is reached.

NO

Set the timer according to the charging time suitable for the open-circuit voltage. Refer to the "Battery condition checking steps" section.

If current does not exceed standard charging current after 5 minutes, replace the battery.

In case that charging requires more than 5 hours, it is advisable to check the charging current after a lapse of 5 hours. If there is any change in the amperage, readjust the voltage to obtain the standard charging current.

Measure the battery open-circuit voltage after having left the battery unused for more than 30 minutes.  
12.8V or more—Charging is complete.  
12.7V or less—Recharging is required.  
Under 12.0V—Replace the battery.



# BATTERY INSPECTION

INSP  
ADJ



## Charging method using a constant-voltage type charger

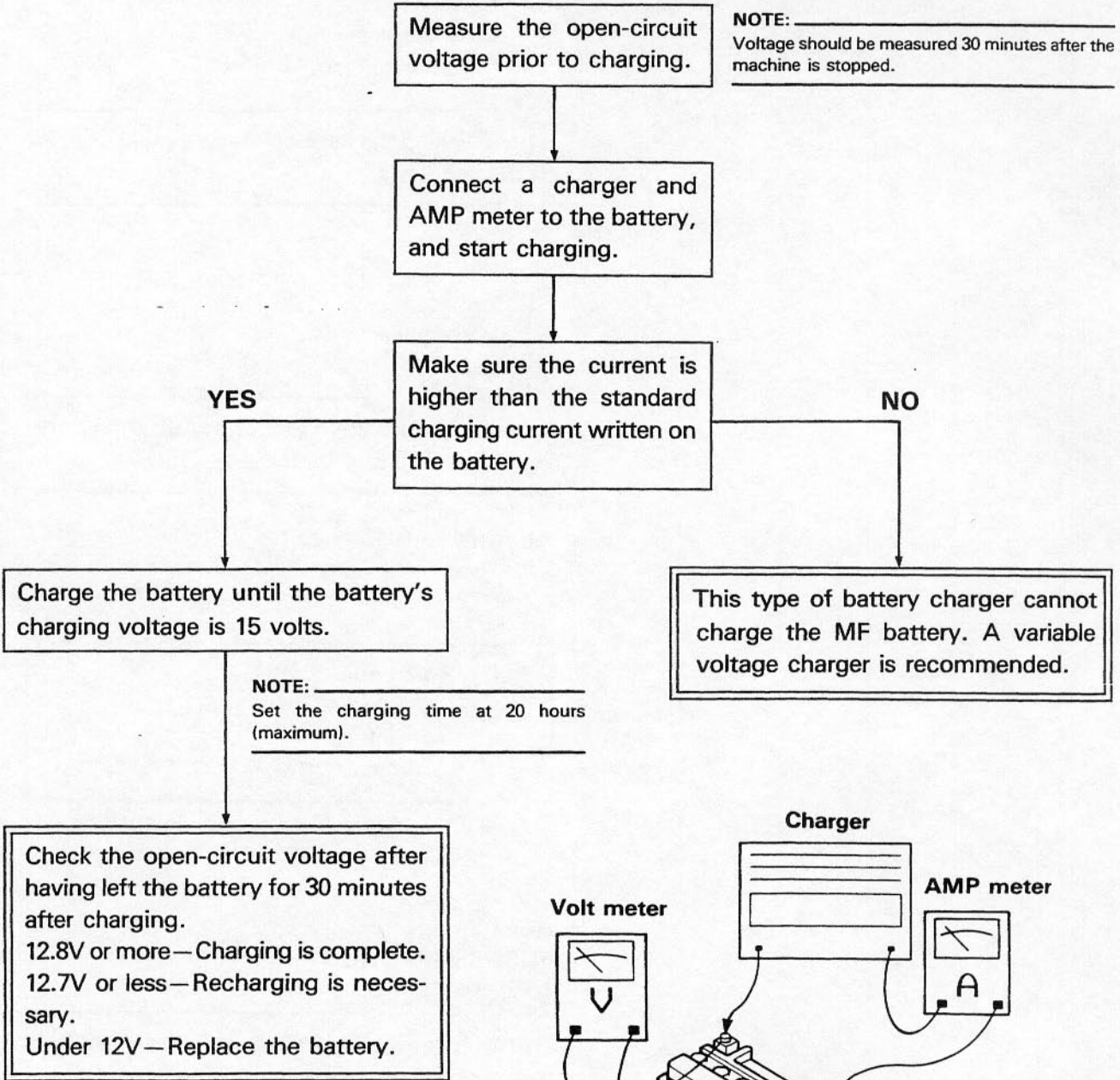

## Charging method using a constant current type charger.

This type charger cannot charge the MF battery.

6. Inspect:

- Battery terminal  
 Dirty terminal → Clean with wire brush.  
 Poor connection → Correct.

**NOTE:** \_\_\_\_\_

After cleaning the terminals, apply grease lightly to the terminals.

7. Install:

- Battery

8. Connect:

- Battery leads

**CAUTION:** \_\_\_\_\_

Connect the positive lead first and then connect the negative lead.

9. Install:

- Side cover (left)
- Seat

	<b>Bolt (side cover):</b> 7 Nm (0.7 m•kg, 5.1 ft•lb)
	<b>Bolt (seat):</b> 10 Nm (1.0 m•kg, 7.2 ft•lb)

YB302001

## FUSE INSPECTION

**CAUTION:** \_\_\_\_\_

Don't forget to turn off the main switch when checking or replacing the fuse. Otherwise, it may cause accidental short-circuiting.

1. Remove:

- Seat ①
- Side cover ② (left)  
 Refer to the "SEAT, FUEL TANK AND COVER" section.

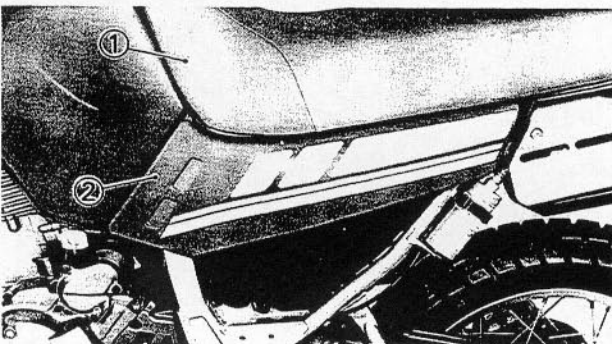

# FUSE INSPECTION

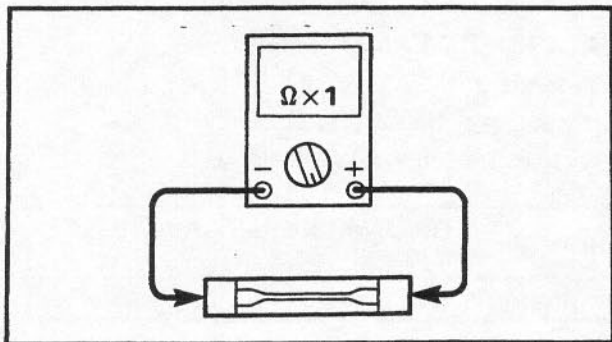
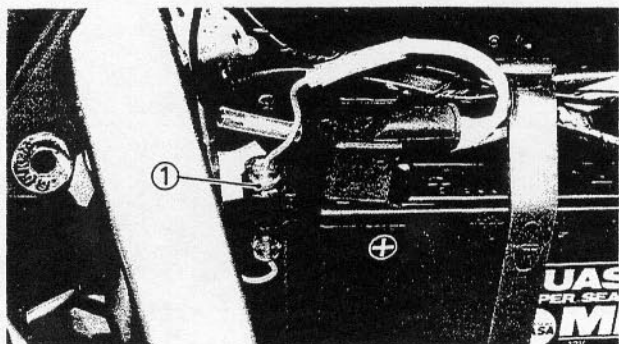

2. Remove:
- Fuse ①

3. Inspect:
- Fuse

\*\*\*\*\*

### Inspection steps:

- Connect the Pocket Tester to the fuse and check it for continuity.

**NOTE:** \_\_\_\_\_

Set the tester selector to " $\Omega \times 1$ " position.



**Pocket tester:**  
P/N. YU-03112  
P/N. 90890-03112

- If the tester is indicated at  $\infty$ . The fuse is blown, replace it.

\*\*\*\*\*

4. Replace:
- Blown fuse

\*\*\*\*\*

### Blown fuse replacement steps:

- Turn off ignition and the circuit.
- Install a new fuse of proper amperage.



**Fuse:**  
20 amps  $\times$  1 pc.

- Turn on switches to verify operation of electrical device.
- If fuse blows immediately again, check circuit in question.

\*\*\*\*\*

### **! WARNING** \_\_\_\_\_

Never use a fuse with a rating other than specified, or other, material in place of a fuse. An improper fuse may cause damage to the electrical system and possible cause a fire, or the lighting and/or ignition may cease to function.



# HEADLIGHT BEAM ADJUSTMENT/ HEADLIGHT BULB REPLACEMENT

INSP  
ADJ



## 5. Install:

- Side cover (left)
- Seat



**Bolt (side cover):**

7 Nm (0.7 m•kg, 5.1 ft•lb)

**Bolt (seat):**

10 Nm (1.0 m•kg, 7.2 ft•lb)

YB203001

## HEADLIGHT BEAM ADJUSTMENT

### 1. Adjust:

- Headlight beam (vertical)  
Turn the adjuster ① in or out.

Turning in	Headlight beam moves to lower.
Turning out	Headlight beam moves to raise.

### 2. Adjust:

- Headlight beam (horizontal)  
Turn the adjuster ② in or out.

Turning in	Headlight beam moves to right.
Turning out	Headlight beam moves to left.

YB203003

## HEADLIGHT BULB REPLACEMENT

### 1. Remove:

- Inner panel ①  
Refer to the "COWLING" section.

### 2. Disconnect:

- Headlight leads ①

### 3. Remove:

- Bulb cover ②

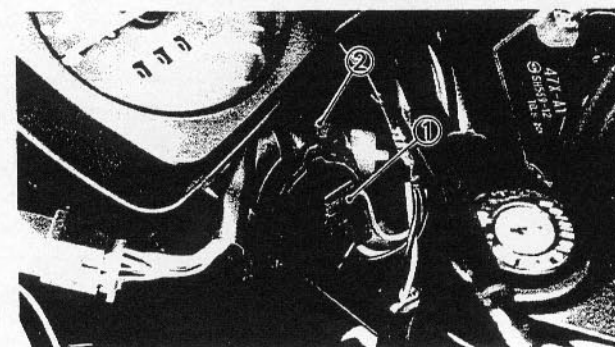
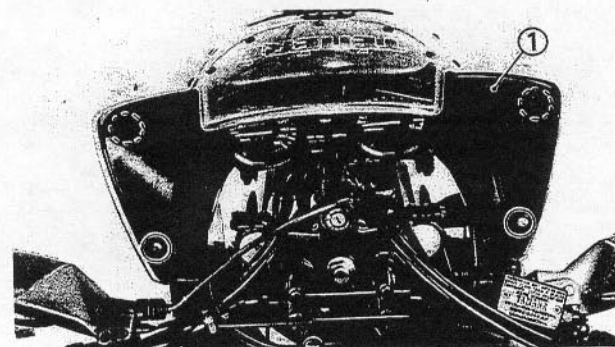
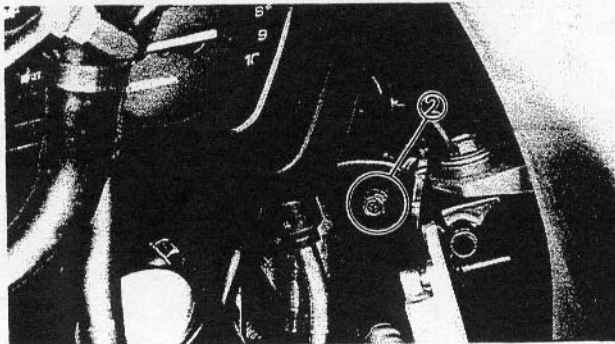
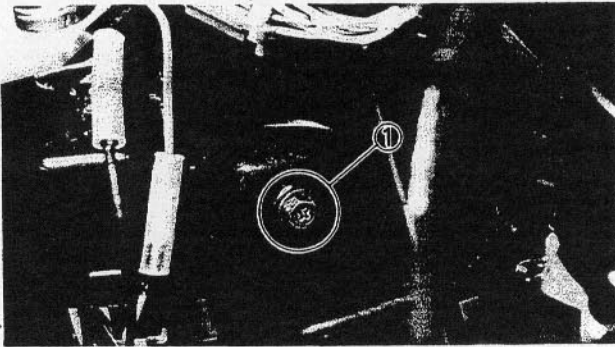

## HEADLIGHT BULB REPLACEMENT

INSP  
ADJ

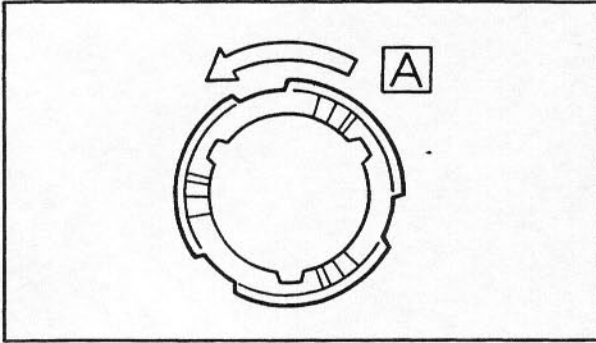

4. Remove:

- Bulb
- Unhook the bulb.

**⚠ WARNING**

Keep flammable products and your hands away from the bulb while it is on, it will be hot. Do not touch the bulb until it cools down.

**A** Turn

5. Install:

- Bulb (new)
- Secure the new bulb with the bulb holder.

**CAUTION:**

Avoid touching glass part of bulb. Also keep it free from oil otherwise, transparency of glass, bulb life and illuminous flux will be adversely affected. If oil gets on bulb, clean it with a cloth moistened thoroughly with alcohol or lacquer thinner.

6. Install:

- Bulb cover

7. Connect:

- Headlight leads

8. Install:

- Inner panel



## CHAPTER 4. ENGINE OVERHAUL

<b>ENGINE REMOVAL</b> .....	E-7
SEAT, FUEL TANK AND COVER .....	E-7
ENGINE GUARD .....	E-7
ENGINE OIL AND COOLANT .....	E-7
BATTERY LEADS .....	E-7
RADIATOR .....	E-7
EXHAUST PIPE AND MUFFLER .....	E-8
OIL TANK HOSE .....	E-8
AIR FILTER CASE AND CARBURETOR .....	E-8
CABLES AND LEADS .....	E-9
DRIVE CHAIN .....	E-9
ENGINE REMOVAL .....	E-10
<b>ENGINE DISASSEMBLY</b> .....	E-11
PIPE, STARTER MOTOR AND HOSES .....	E-11
CYLINDER HEAD, CYLINDER AND PISTON .....	E-11
ROTOR AND STARTER DRIVES .....	E-13
OIL FILTER AND WATER PUMP .....	E-14
CLUTCH AND BALANCER GEAR .....	E-15
SHIFT LEVER AND OIL PUMP .....	E-16
CRANKCASE (RIGHT) .....	F-1
OIL STRAINER .....	F-2
BALANCER, TRANSMISSION AND SHIFTER .....	F-2
CRANKSHAFT .....	F-3
ROCKER ARM .....	F-3
VALVES .....	F-4
<b>INSPECTION AND REPAIR</b> .....	F-5
CYLINDER HEAD .....	F-5
VALVE SEAT .....	F-5
VALVE AND VALVE GUIDE .....	F-7
VALVE SPRING .....	F-8
CAMSHAFT .....	F-8
DECOMPRESSION .....	F-9
ROCKER ARM AND ROCKER ARM SHAFT .....	F-9
TIMING CHAIN, SPROCKET AND CHAIN GUIDE .....	F-10
CYLINDER AND PISTON .....	F-10
PISTON RING .....	F-11
PISTON PIN .....	F-11
CRANKSHAFT .....	F-12
BALANCER DRIVE GEAR AND BALANCER GEAR .....	F-13
ELECTRIC STARTER DRIVE .....	F-13
PRIMARY DRIVE .....	F-13
CLUTCH .....	F-13
TRANSMISSION AND SHIFTER .....	F-14
OIL PUMP, WATER PUMP AND STRAINER .....	F-15
OIL DELIVERY PIPES .....	F-16
CRANKCASE .....	F-16
BEARING AND OIL SEAL .....	F-16
CIRCLIP AND WASHER .....	G-1





---

<b>ENGINE ASSEMBLY AND ADJUSTMENT</b> .....	G-2
<b>VALVES</b> .....	G-2
<b>ROCKER ARM</b> .....	G-3
<b>CRANKSHAFT</b> .....	G-4
<b>BALANCER, TRANSMISSION AND SHIFTER</b> .....	G-6
<b>OIL STRAINER</b> .....	G-8
<b>CRANKCASE (RIGHT)</b> .....	G-8
<b>SHIFT LEVER AND OIL PUMP</b> .....	G-9
<b>CLUTCH AND BALANCER GEAR</b> .....	G-12
<b>OIL FILTER AND WATER PUMP</b> .....	G-14
<b>ROTOR AND STARTER DRIVES</b> .....	G-15
<b>CYLINDER HEAD, CYLINDER AND PISTON</b> .....	H-2
<b>PIPES AND HOSES</b> .....	H-5
<b>REMOUNTING ENGINE</b> .....	H-6



YB241000

## ENGINE OVERHAUL ENGINE REMOVAL

### NOTE:

It is not necessary to remove the engine in order to remove the following components:

- Cylinder head
- Cylinder
- Piston
- Clutch
- Water pump
- AC magneto

YB241001

### SEAT, FUEL TANK AND COVER

#### 1. Remove:

- Seat
- Side covers
- Air scoops
- Fuel tank

Refer to the "SEAT, FUEL TANK AND COVER" section in the CHAPTER 3.

YB241004

### ENGINE GUARD

#### 1. Remove:

- Engine guard ①

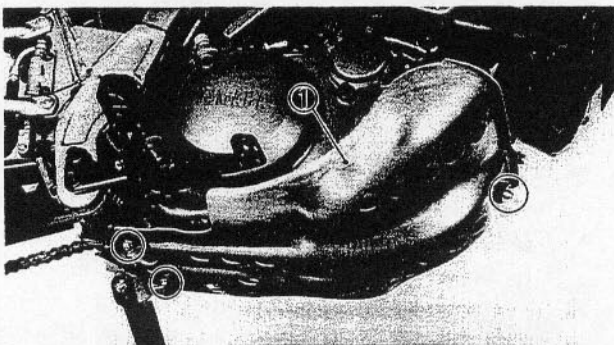

YB241002

### ENGINE OIL AND COOLANT

#### 1. Drain:

- Oil tank ①
- Crankcase ②  
(of them oil)

Refer to the "ENGINE OIL REPLACEMENT" section in the CHAPTER 3.

- Oil hose ③

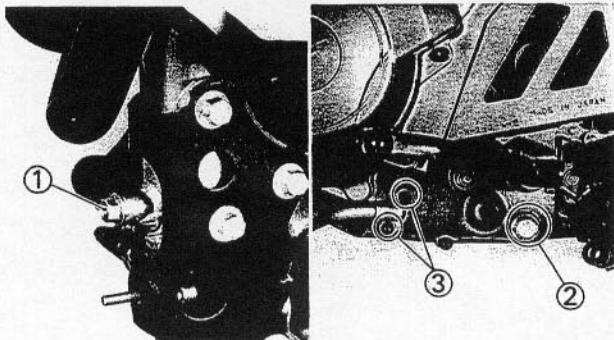



## 2. Drain:

- Radiator
- Recovery tank
- Crankcase  
(of them coolant)

Refer to the "COOLANT REPLACEMENT" section in the CHAPTER 3.

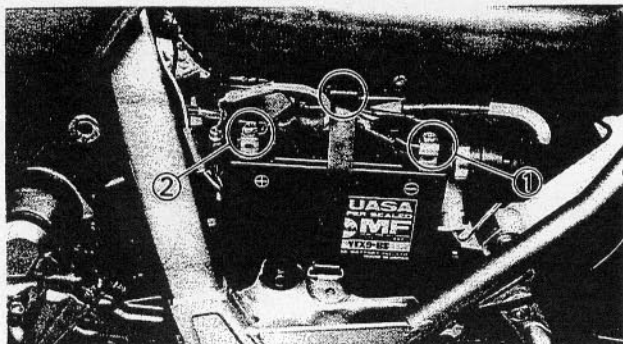

YB241003

## BATTERY LEADS

### 1. Disconnect:

- Battery leads

### CAUTION:

Disconnect the negative lead ① first and then disconnect the positive lead ②.

## 2. Remove:

- Battery

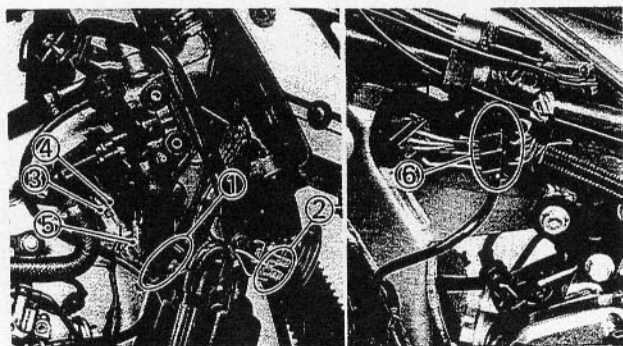

YB241008

## RADIATOR

### 1. Disconnect:

- Band ①
- Horn leads ②
- Thermo switch ③
- Thermo unit ④
- Earth lead ⑤
- Fan motor lead coupler ⑥

## 2. Loosen:

- Screw ① (hose clamp)

## 3. Disconnect:

- Radiator hose ②  
(from water pump)

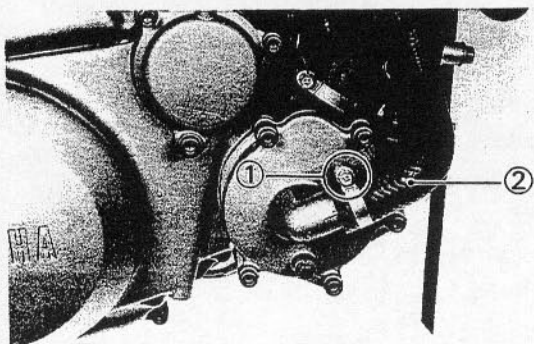



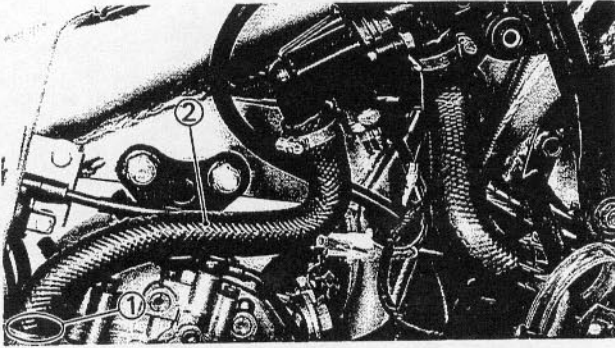

4. Loosen:
  - Screws ① (hose clamp)

5. Disconnect:
  - Radiator hose ②

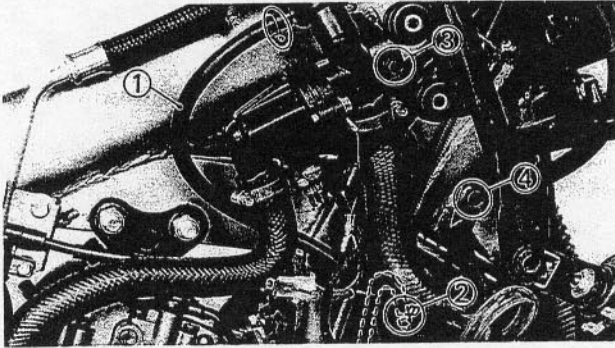

6. Disconnect:
  - Recovery tank hose ①
  - Breather hose ② (recovery tank)

7. Remove:
  - Bolt ③ (conduction)
  - Bolt ④ (radiator stay)

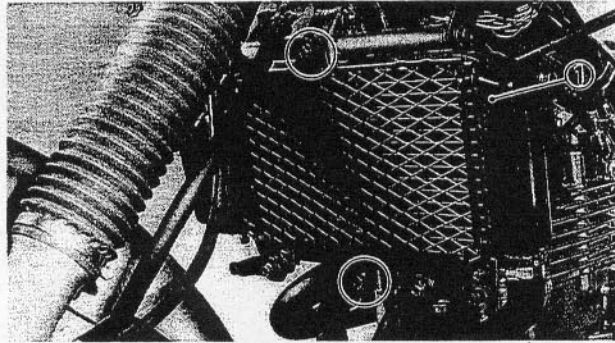

8. Remove:
  - Radiator ①

YB241005

## EXHAUST PIPE AND MUFFLER

1. Loosen:
  - Bolt ① (clamp)
  - Bolt ② (clamp)

2. Remove:
  - Muffler ①

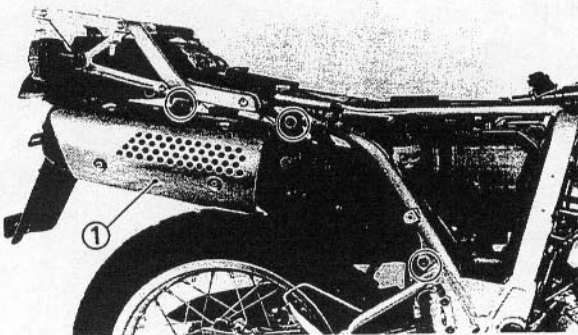
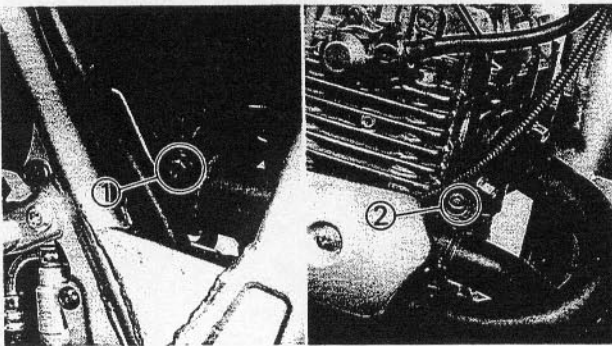

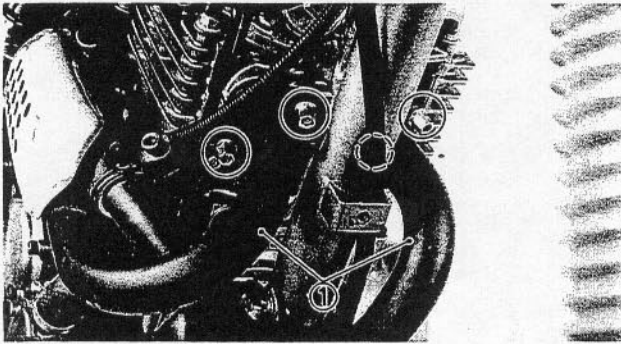

3. Remove:
  - Exhaust pipe ①

YB241006

### OIL TANK HOSE

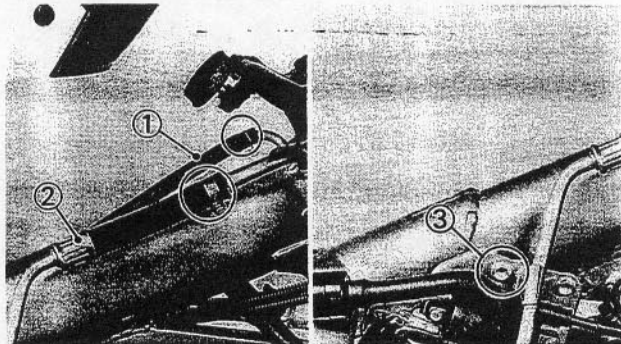

1. Disconnect:
  - Breather hose ① (from crankcase)
  - Oil hose ② (from crankcase)
2. Remove:
  - Screw ③ (oil hose)

YB241007

### AIR FILTER CASE AND CARBURETOR

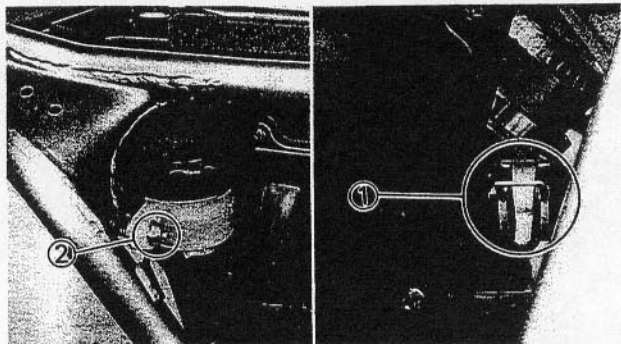

1. Disconnect:
  - Breather hose ① (from crankcase)
2. Remove:
  - Bolt ② (rear brake reservoir tank)

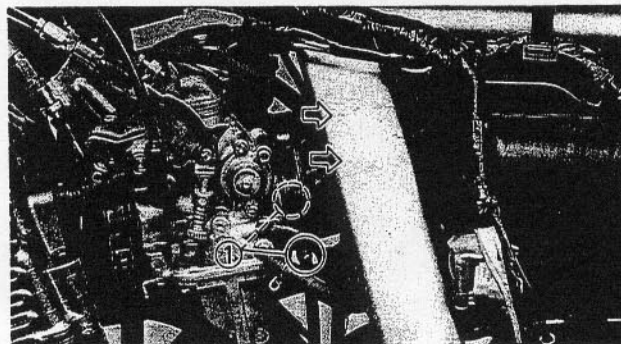

3. Loosen:
  - Screws ① (carburetor joints)

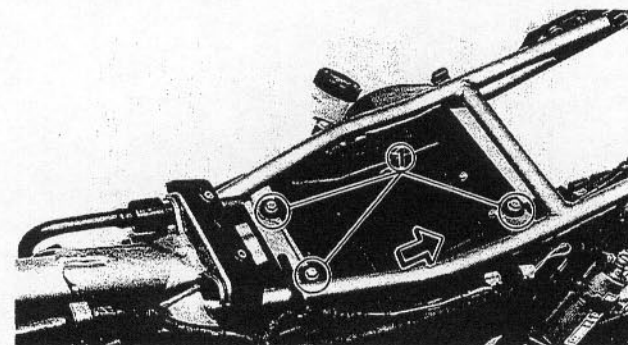

4. Remove:
  - Bolt ① (air filter case)
 Carburetor joint from carburetor by moving air filter case to the rear.

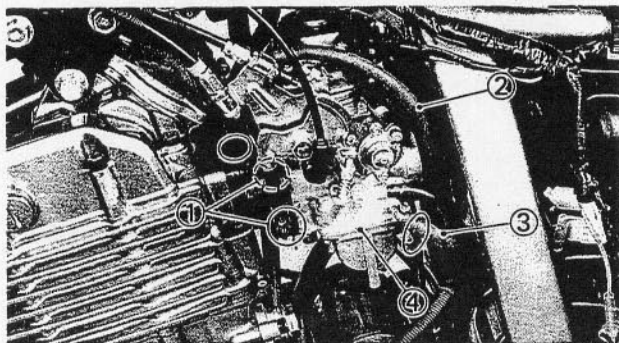

5. Loosen:
  - Screws ① (intake manifold)
  
6. Disconnect:
  - Vacuum hose ②
  - Delivery hose ③
  - Carburetors ④  
(from intake manifold)

**NOTE:**

Cover the carburetor with a clean rag to prevent dirt or foreign material from entering the carburetor.

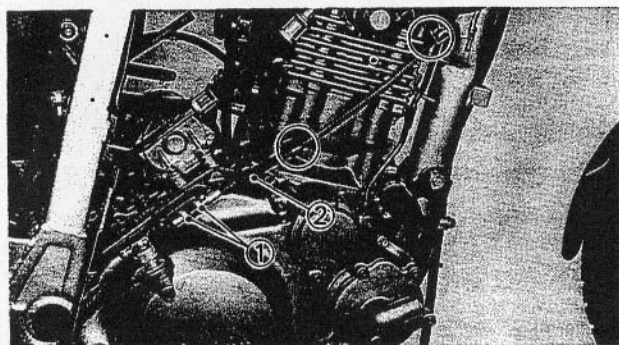

YB241009

**CABLES AND LEADS**

1. Loosen:
  - Nuts ①
  
2. Disconnect:
  - Clutch cable ②  
(from pull lever and cable clamps)
  
3. Disconnect:
  - Spark plug lead ①  
(from spark plug)

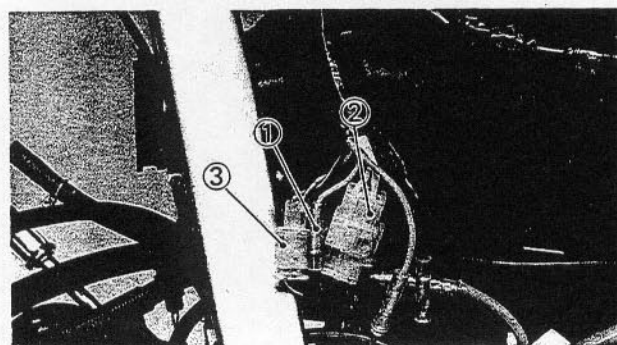
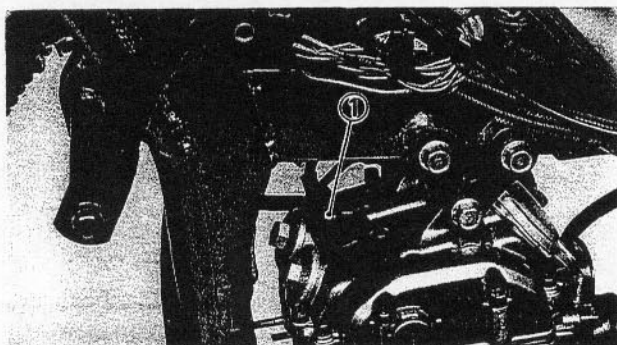

4. Disconnect:
  - Neutral switch lead ①
  - AC magneto lead ②
  - Pickup coil lead ③



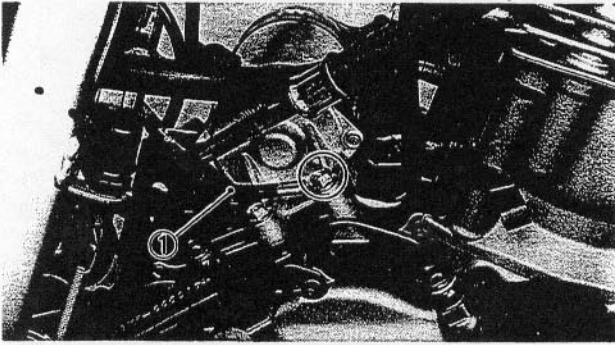

5. Disconnect:
  - Ground lead ①  
(from crankcase cover)

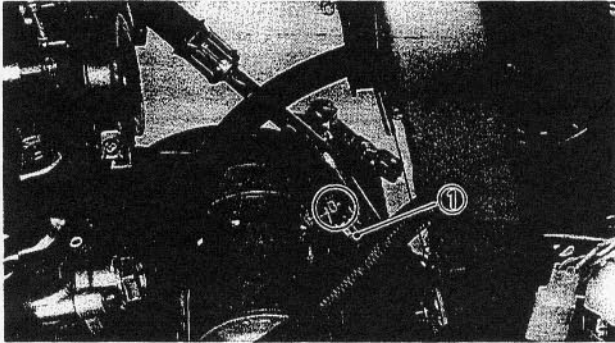

6. Disconnect:
  - Starter motor lead ①  
(from starter motor)

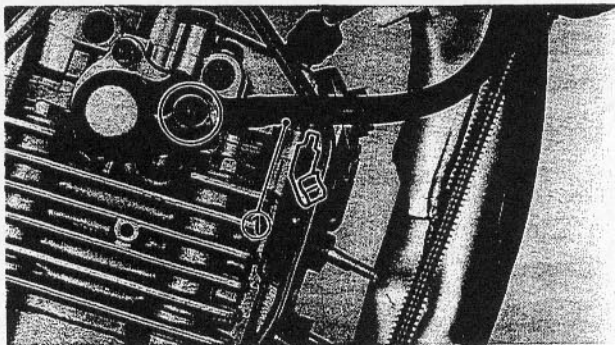

7. Disconnect:
  - Tachometer cable ①

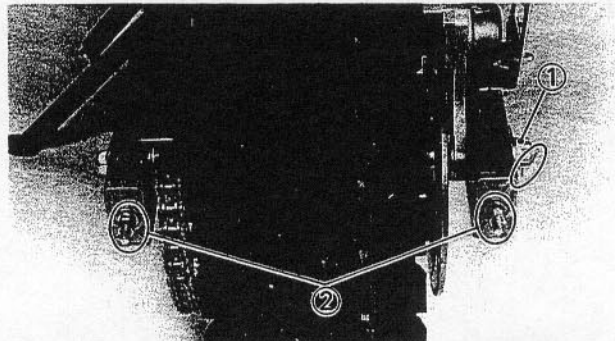

YB241010

## DRIVE CHAIN

1. Remove:
  - Cotter pin ①
2. Loosen:
  - Axle nut ①
  - Nuts ② (chain pullers)

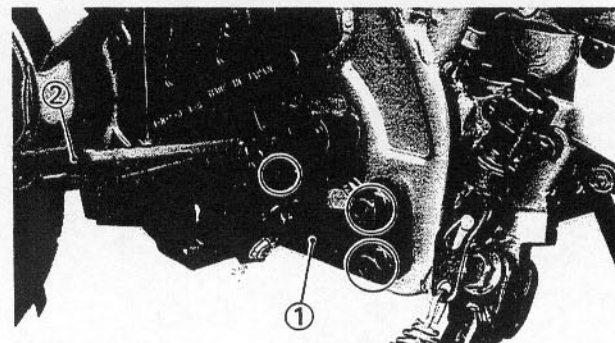

3. Remove:
  - Footrest ① (left)
  - Shift pedal ②

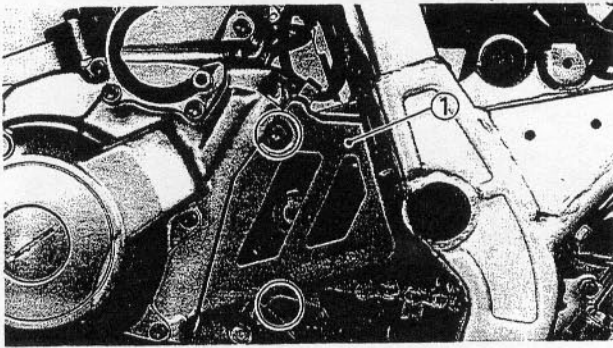

4. Remove:
- Cover ①

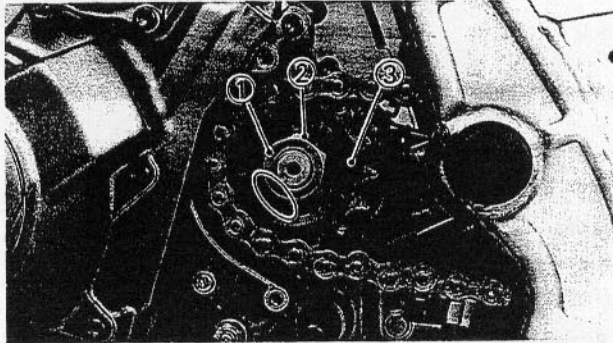

5. Straighten:
- Lock washer tab

6. Remove:
- Nut ①
  - Lock washer ②
  - Drive sprocket ③

**NOTE:** \_\_\_\_\_  
Loosen the nut while applying the rear brake.

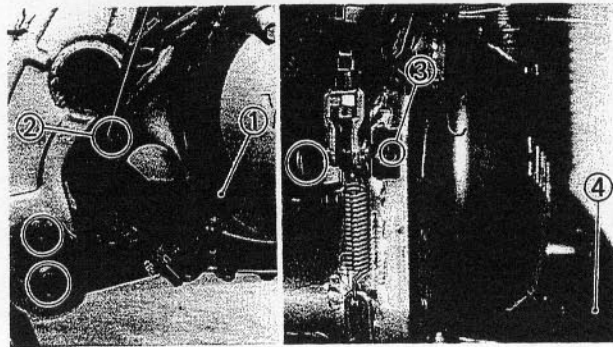

7. Remove:
- Footrest ① (right)

8. Disconnect:
- Rear brake switch ②
  - Clip ③

9. Remove:
- Rear brake pedal ④

YB241011

## ENGINE REMOVAL

1. Place suitable stand under the frame and engine.

### **⚠ WARNING** \_\_\_\_\_

Securely support the motorcycle so there is no danger of it falling over.

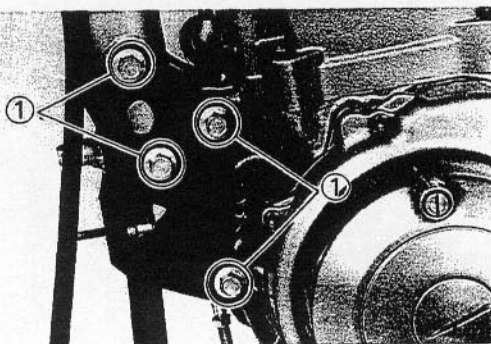

2. Remove:
- Mounting bolts ① (front—lower)

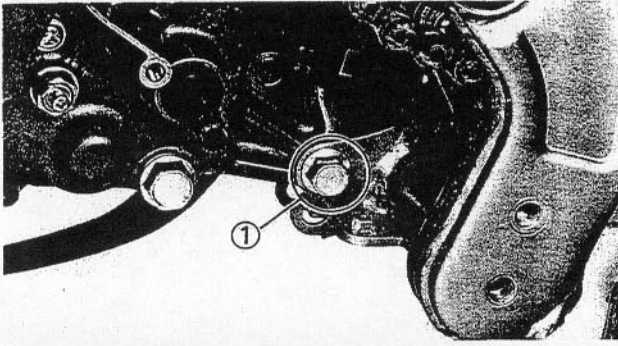

3. Remove:
- Mounting bolt ① (rear—lower)

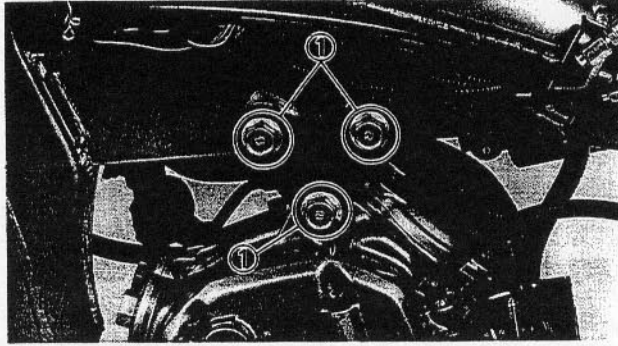

4. Remove:
- Mounting bolts ① (front—upper)

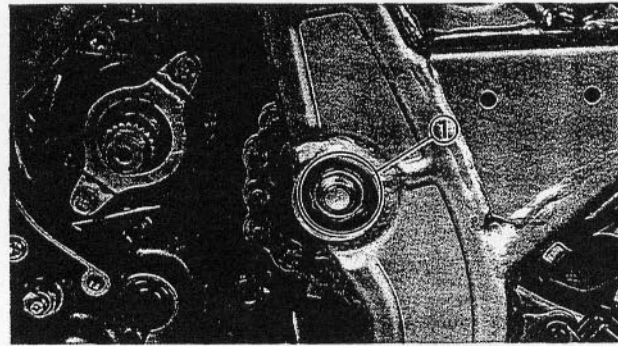

5. Remove:
- Pivot shaft cap (left and right)
  - Pivot shaft ①

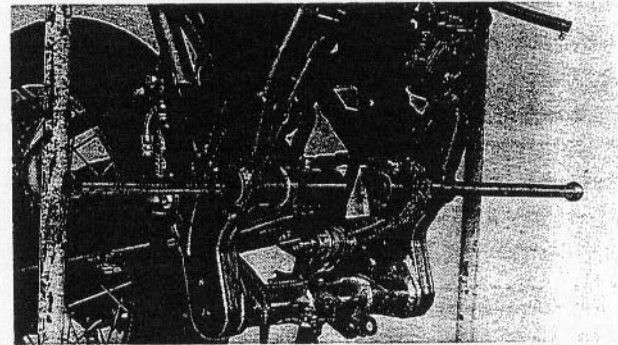

**NOTE:** \_\_\_\_\_  
The engine and swingarm are installed using the same pivot shaft. Therefore, take care so that the pivot shaft is pulled, not entirely out, but for enough to set the engine free.  
\_\_\_\_\_

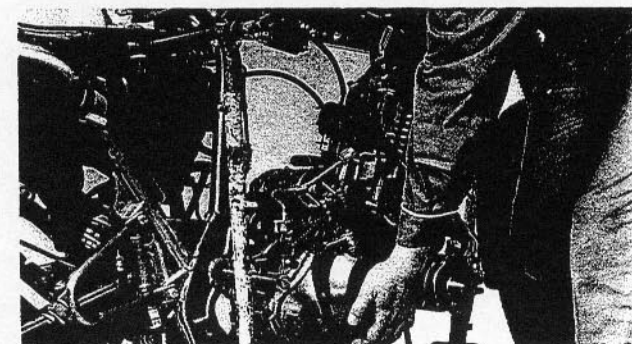

6. Remove:
- Engine assembly  
(from right side of motorcycle)





YB242001

## ENGINE DISASSEMBLY PIPE, STARTER MOTOR AND HOSES

## 1. Remove:

- Oil pipe ①

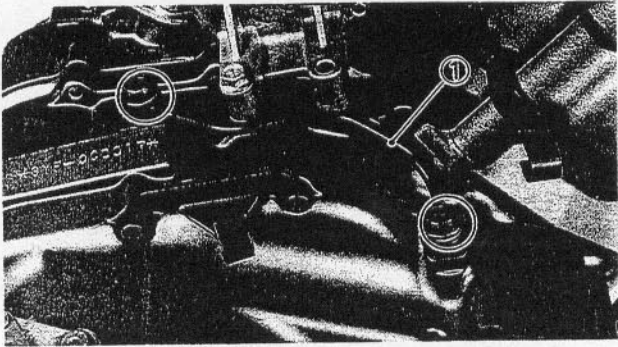

## 2. Remove:

- Oil pipe ①

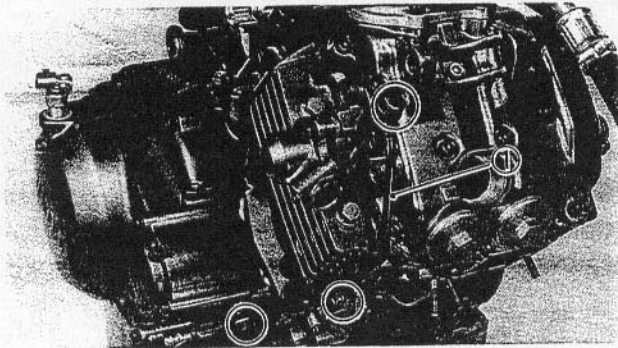

## 3. Remove:

- Starter motor ①

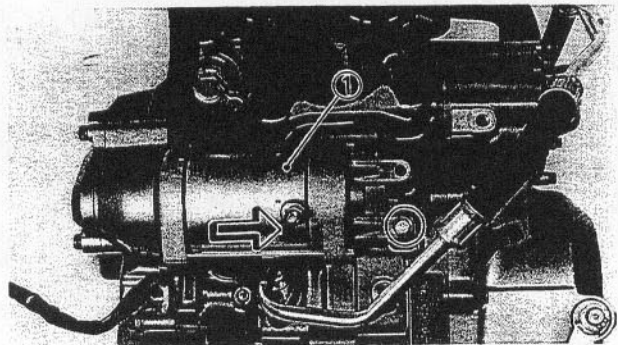

## 4. Remove:

- Oil hose ①
- Breather hose ② (crankcase)
- Breather hose ③ (oil tank)

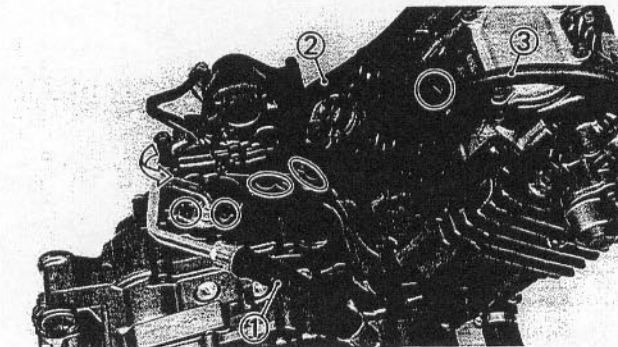

## 5. Remove:

- Coolant hose ①

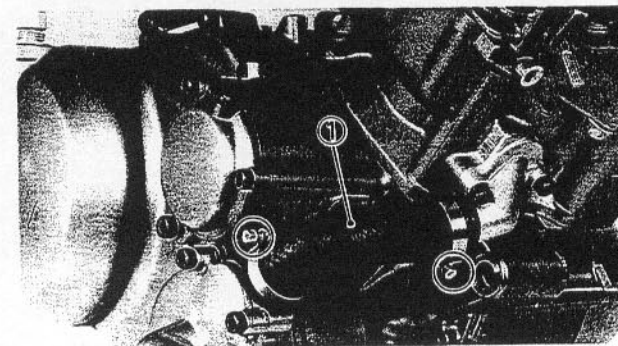



YB342002

**CYLINDER HEAD, CYLINDER AND PISTON****NOTE:** \_\_\_\_\_

With the engine mounted, the cylinder head cover, camshaft and cylinder head can be maintained by removing the following parts.

- Seat
  - Side covers
  - Air scoops
  - Fuel tank
  - Engine guard
  - Radiator
  - Exhaust pipes
  - Ignition coil
  - Oil tank breather hose
  - Carburetor
- 

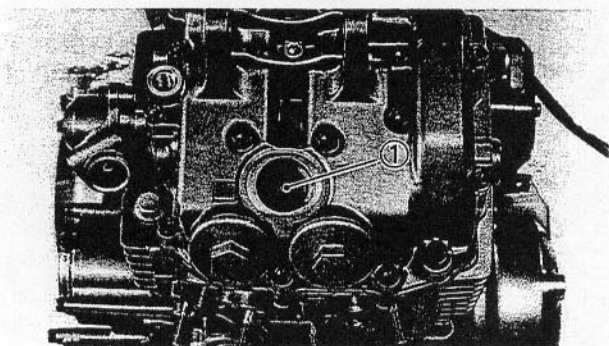
**1. Remove:**

- Spark plug ①

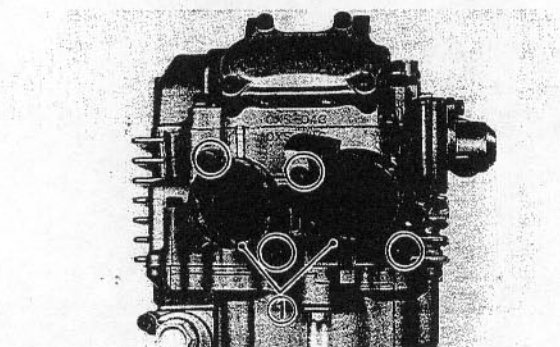
**2. Remove:**

- Intake manifolds ①

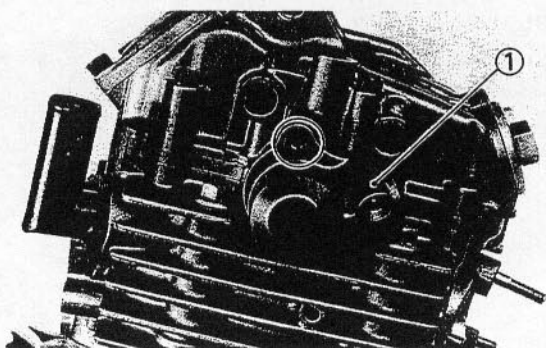
**3. Remove:**

- Tachometer gear unit ①

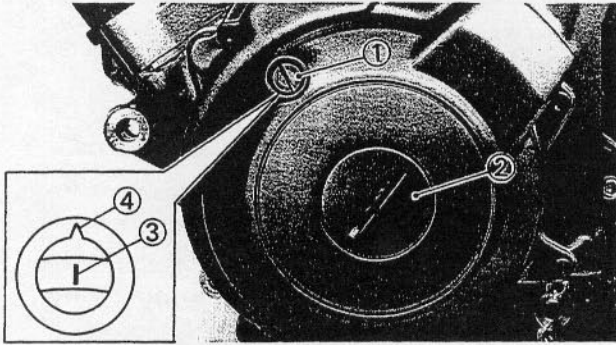

4. Remove:

- Timing plug ①
- Plug (center) ②

5. Turn:

- Crankshaft  
(until TDC mark ③ is aligned with stationary pointer ④)

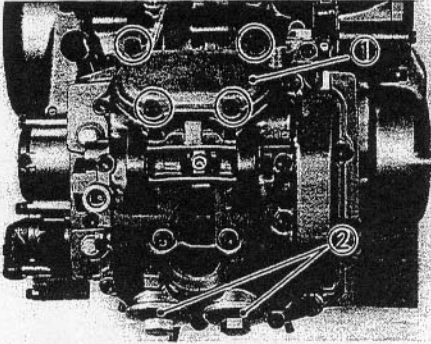

6. Remove:

- Tappet cover (intake) ①
- Tappet cover (exhaust) ②

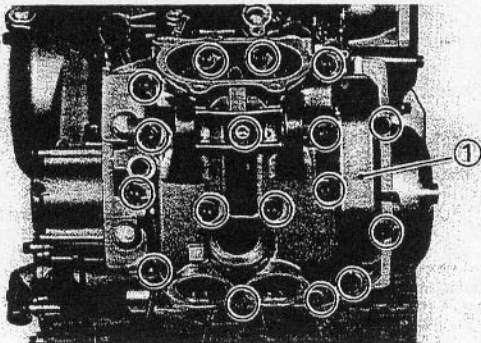

7. Remove:

- Cylinder head cover ①

**NOTE:** \_\_\_\_\_

Working in a crisscross pattern, loosen the bolts 1/4 turn each. Remove them after all are loosened.

---

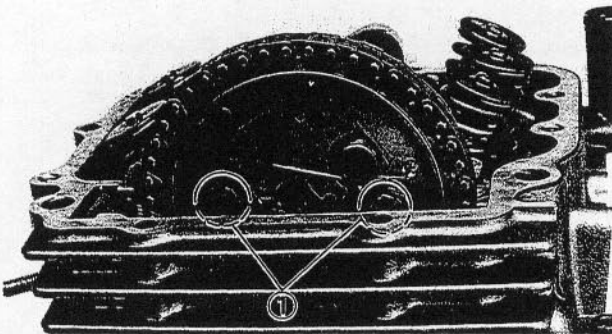

8. Loosen:

- Bolts ① (cam sprocket)

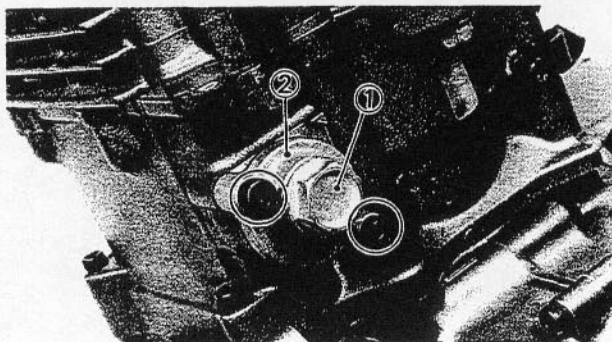

9. Loosen:

- Cap bolt ① (chain tensioner )

10. Remove:

- Chain tensioner ②





11. Remove:

- Cam sprocket ①
- Camshaft ②

NOTE:

- Fasten a safety wire ③ to the timing chain to prevent it from falling into the crankcase.
- Do not fall the stopper guide plate ④ into the crankcase when removing the bolts (cam sprocket).

12. Remove:

- Chain guide ① (exhaust)

13. Remove:

- Pipe ①
- O-ring
- Bolts ②
- Bolts ③
- Bolts ④

NOTE:

Working in a crisscross pattern, loosen the bolts 1/4 turn each. Remove them after all are loosened.

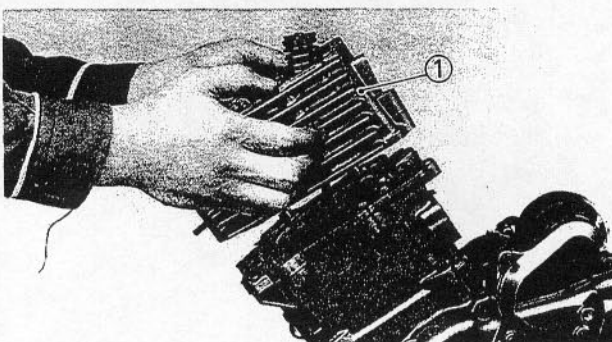
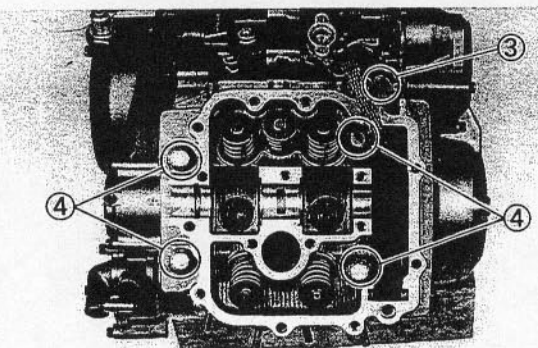
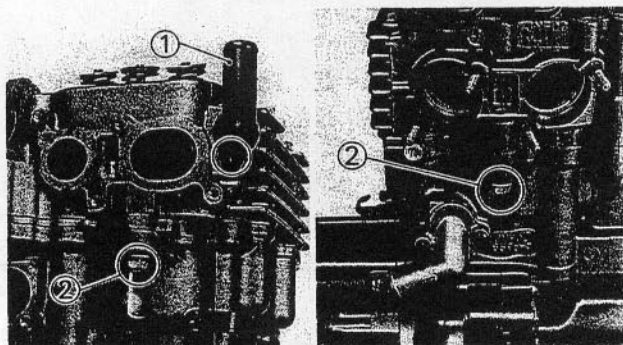
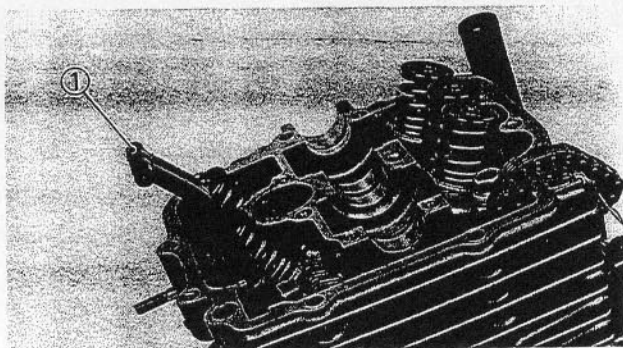
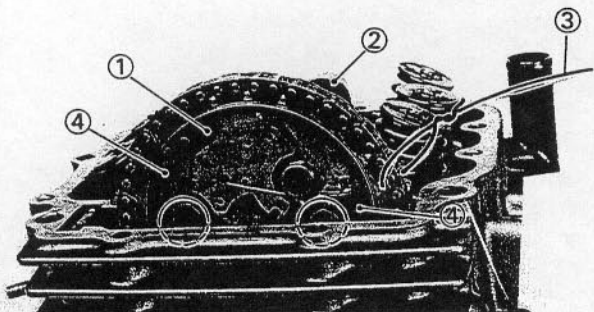

14. Remove:

- Cylinder head ①

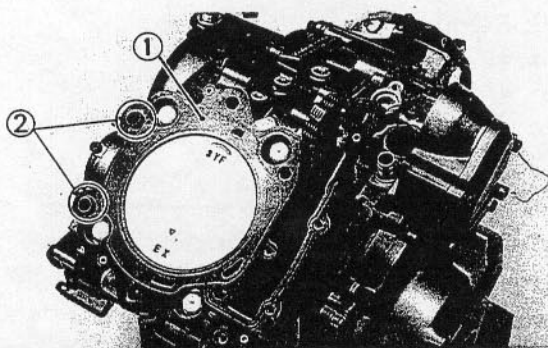

15. Remove:

- Gasket ① (cylinder head)
- Dowel pins ②

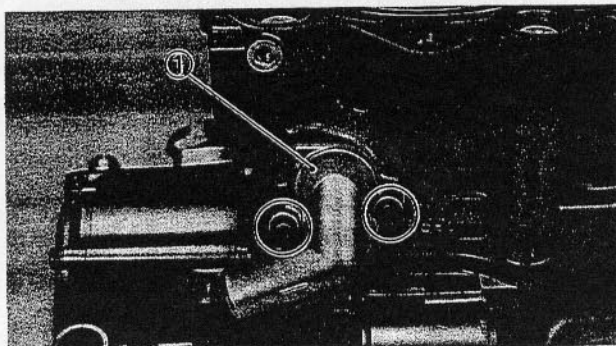

16. Remove:

- Pipe ①

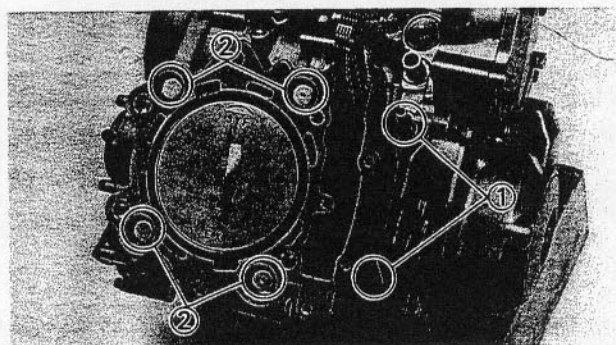

17. Remove:

- Bolts ①
- Bolts ②

**NOTE:** \_\_\_\_\_

Working in a crisscross pattern, loosen the bolts 1/4 turn each. Remove them after all are loosened.

\_\_\_\_\_

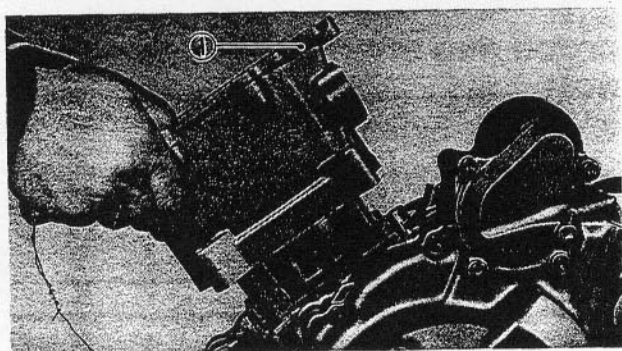

18. Remove:

- Cylinder ①

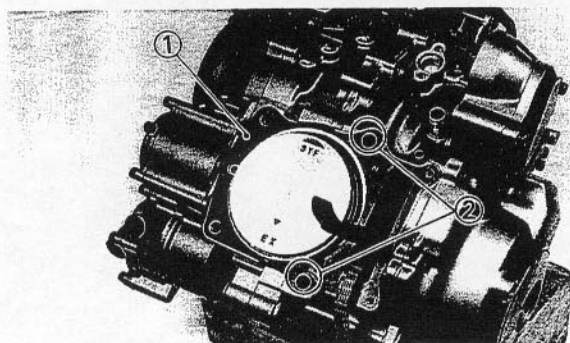

19. Remove:

- Gasket ① (cylinder)
- Dowel pins ②

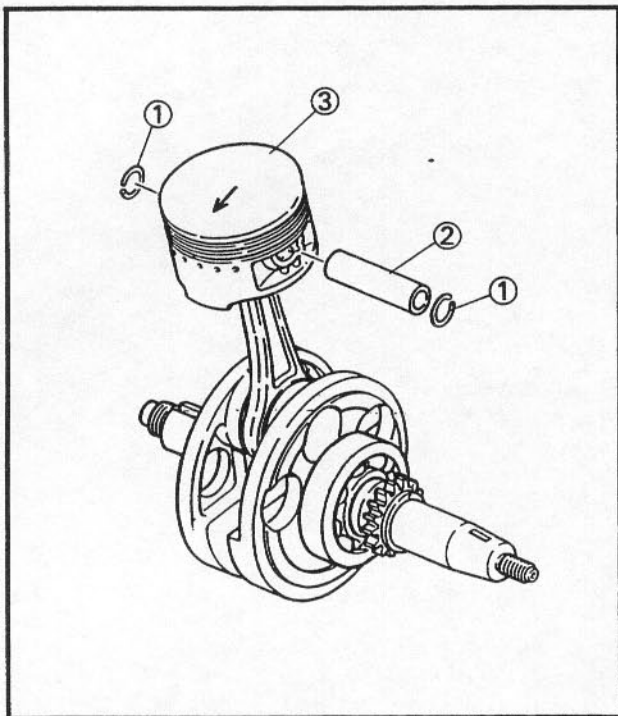

20. Remove:

- Piston pin circlip ①
- Piston pin ②
- Piston ③

**NOTE:**

- Before removing the piston pin circlip, cover the crankcase with a clean rag to prevent the circlip from falling into the crankcase cavity.
- Before removing the piston pin, deburr the clip grooved and pin hole area. If the piston pin groove is deburred and piston pin is still difficult to remove, use the piston pin puller.



**Piston pin puller:**  
P/N. YU-01304, 90890-01304

**CAUTION:**

Do not use a hammer to drive the piston pin out.

YB342003

### ROTOR AND STARTER DRIVERS

**NOTE:**

With the engine mounted, the AC magneto and starter drives can be maintained by removing the following part.

- Engine guard

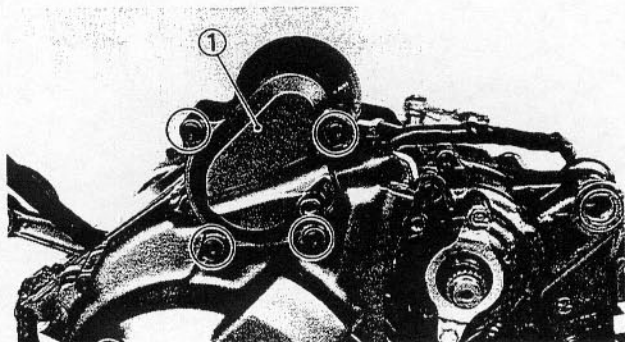

1. Remove:

- Cover ①



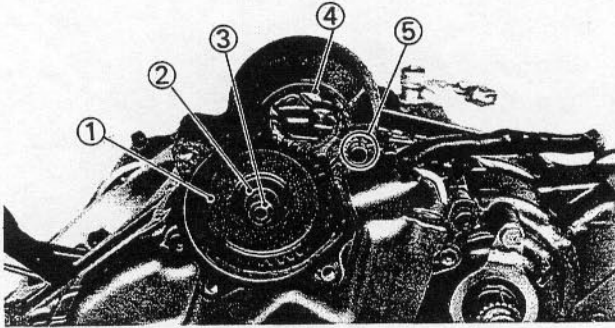

### 2. Remove:

- Starter idle gear 1 ①
- Needle bearing ②
- Shaft ③
- Gasket ④
- Dowel pin ⑤

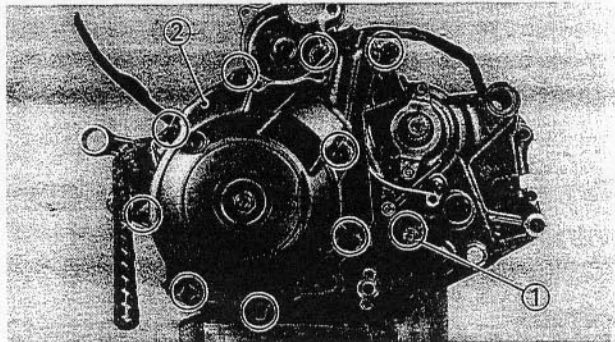

### 3. Disconnect:

- Neutral switch lead ①

### 4. Remove:

- Crankcase cover ② (left)

### NOTE:

Working in a crisscross pattern, loosen the bolts 1/4 turn each. Remove them after all are loosened.

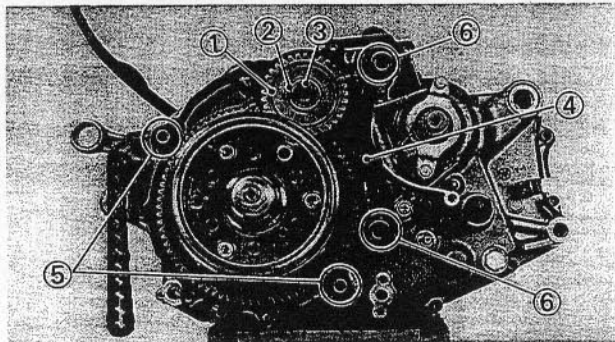

### 5. Remove:

- Starter idle gear 2 ①
- Needle bearing ②
- Shaft ③
- Gasket ④ (crankcase cover)
- Dowel pins ⑤
- O-rings ⑥

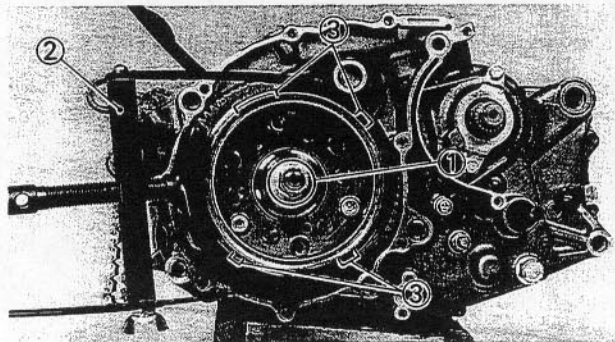

### 6. Remove

- Nut ① (rotor)

### NOTE:

Loosen the nut (rotor) while holding the rotor with the rotor holder ②.



**Rotor holder:**

**P/N. YS-01880, 90890-01701**

### CAUTION:

Do not allow the rotor holder to touch the projections ③ on the rotor.

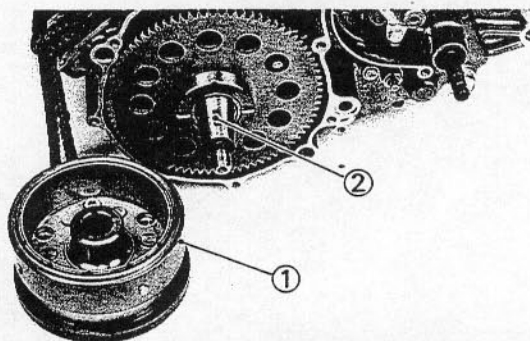

7. Remove:

- Rotor ①
- Woodruff key ②

Use the rotor puller ③ and adapter ④.



**Rotor puller:**

**P/N. YU-33270, 90890-01362**

**Adapter:**

**P/N. YM-04063-A, 90890-04063**

**NOTE:**

Tighten the tool holding bolts, but make sure that the tool body is parallel with the rotor. If necessary, one screw may be backed out slightly to level tool body.

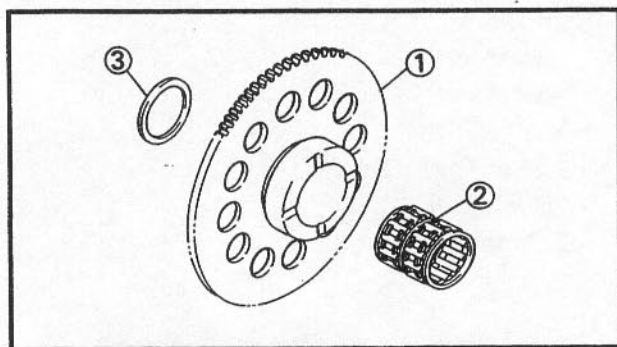
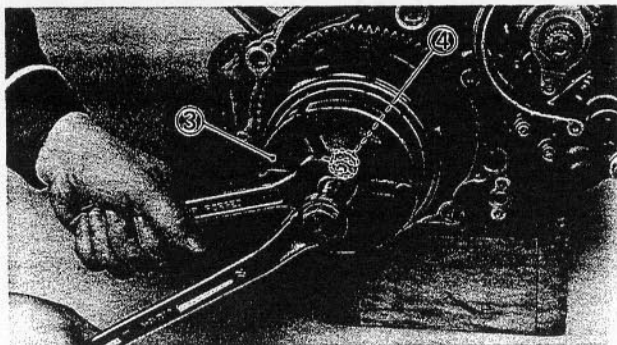

8. Remove:

- Wheel gear ①
- Needle bearing ②
- Washer ③

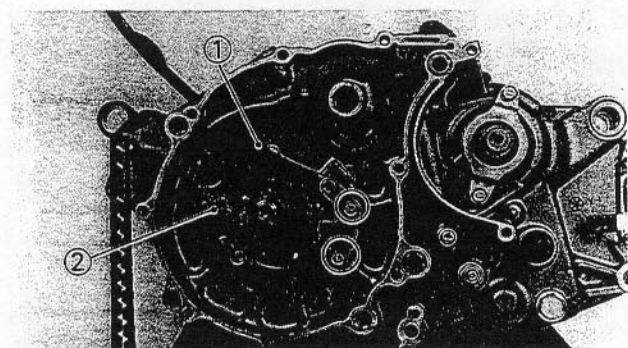

9. Remove:

- Chain guide ①
- Timing chain ②

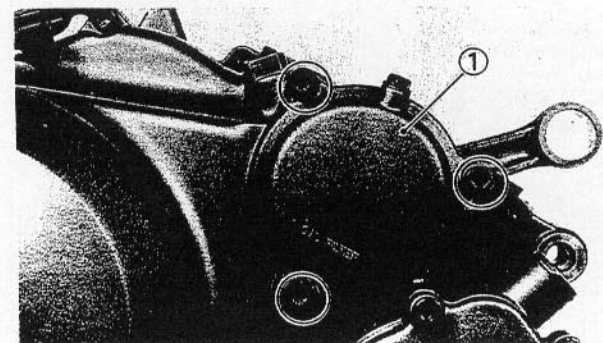

YB342004

## OIL FILTER AND WATER PUMP

**NOTE:**

With the engine mounted, the water pump can be maintained by removing the following part.

- Engine guard

1. Remove:

- Oil filter cover ①

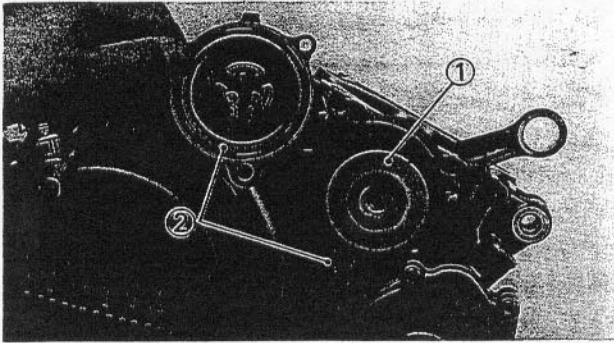

2. Remove:

- Oil filter ①
- O-rings ②

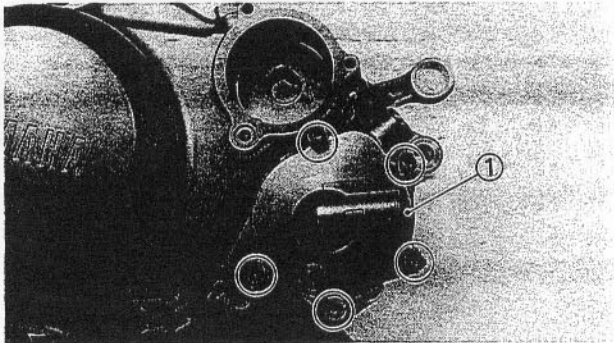

3. Remove:

- Water pump cover ①

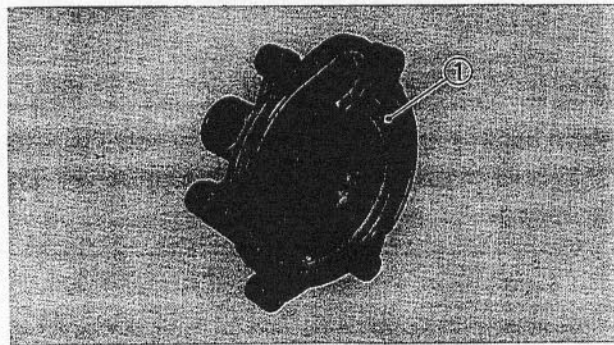

4. Remove:

- O-ring ①

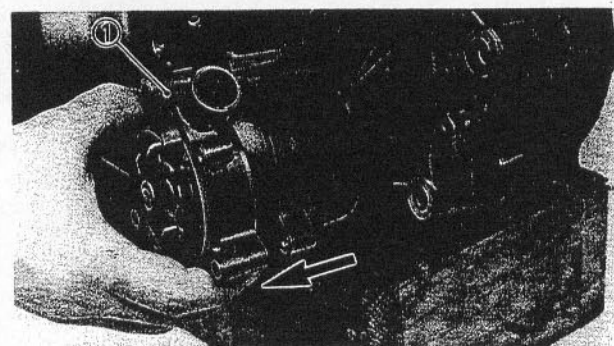

5. Remove:

- Water pump housing ①

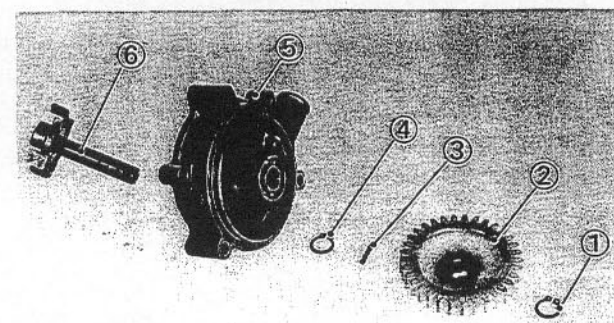

6. Remove:

- Circlip ①
- Water pump gear ②
- Pin ③
- Circlip ④
- Water pump housing ⑤
- Impeller shaft ⑥





### CLUTCH AND BALANCER GEAR

#### NOTE:

With the engine mounted, the clutch can be maintained by removing the following parts.

- Clutch cable
- Engine guard
- Water pump housing
- Footrest (right)
- Brake pedal

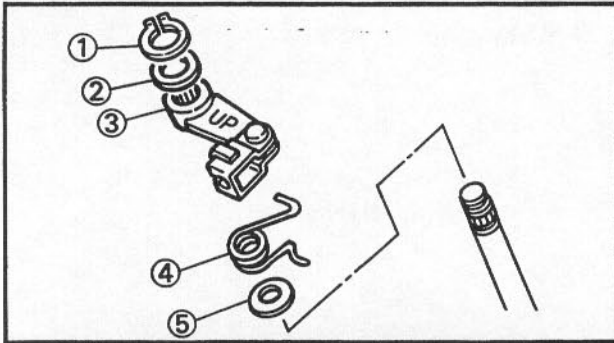

#### 1. Remove:

- Circlip ①
- Washer ②
- Pull lever ③
- Return spring ④
- Washer ⑤

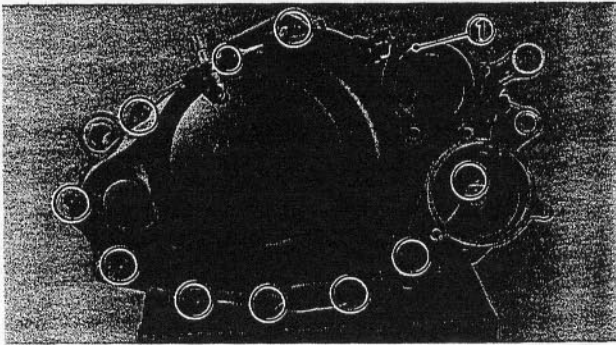

#### 2. Remove:

- Crankcase cover ① (right)

#### NOTE:

Working in a crisscross pattern, loosen the bolts 1/4 turn each. Remove them after all are loosened.

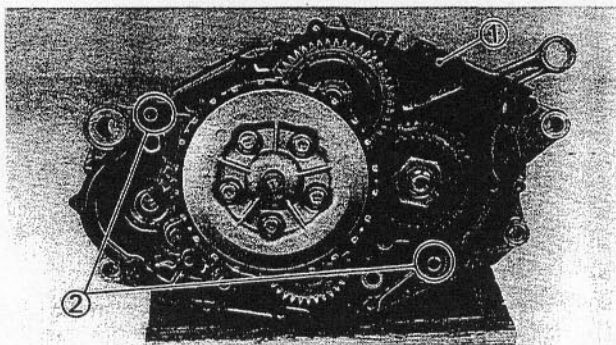

#### 3. Remove:

- Gasket ① (crankcase cover)
- Dowel pins ②

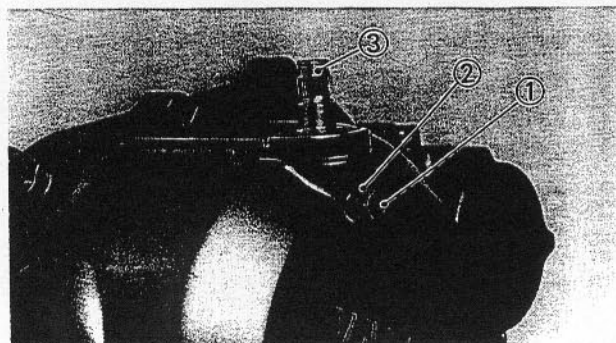

#### 4. Remove:

- Bolt ①
- Washer ②
- Pull lever axle ③  
(from crankcase cover)

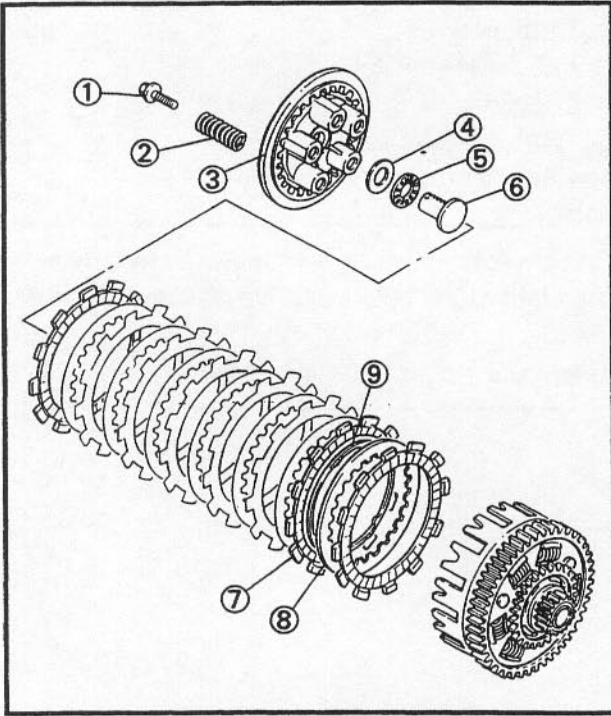

### 5. Remove:

- Bolts ①
- Clutch springs ②
- Pressure plate ③
- Washer ④
- Bearing ⑤
- Pull rod ⑥
- Friction plate ⑦
- Clutch plate ⑧
- Cushion spring ⑨

### NOTE:

Working in a crisscross pattern, loosen the bolts 1/4 turn each. Remove them after all are loosened.

### 6. Straighten:

- Lock washer tab

### 7. Loosen:

- Nut ① (clutch boss)

### NOTE:

Loosen the nut (clutch boss) while holding the clutch boss with universal clutch holder ②.

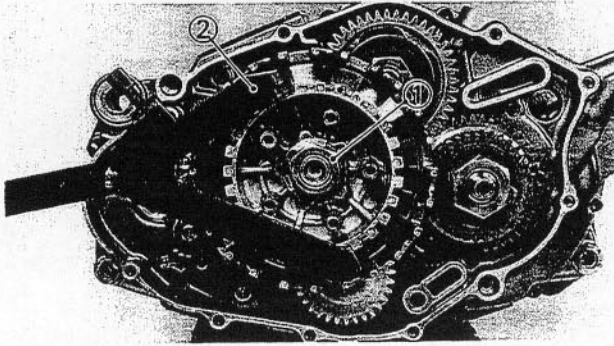

**Universal clutch holder:**

**P/N. YM-91042, 90890-04086**

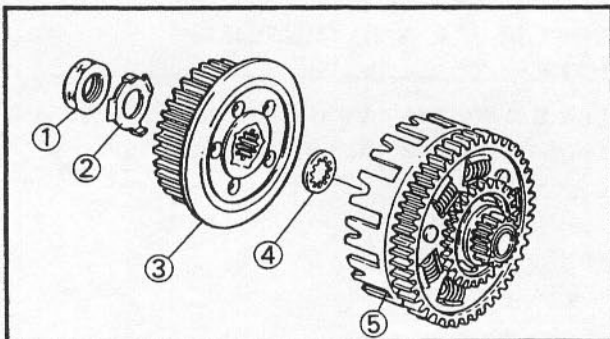

### 8. Remove:

- Nut ① (clutch boss)
- Lock washer ②
- Clutch boss assembly ③
- Thrust plate ④
- Clutch housing ⑤

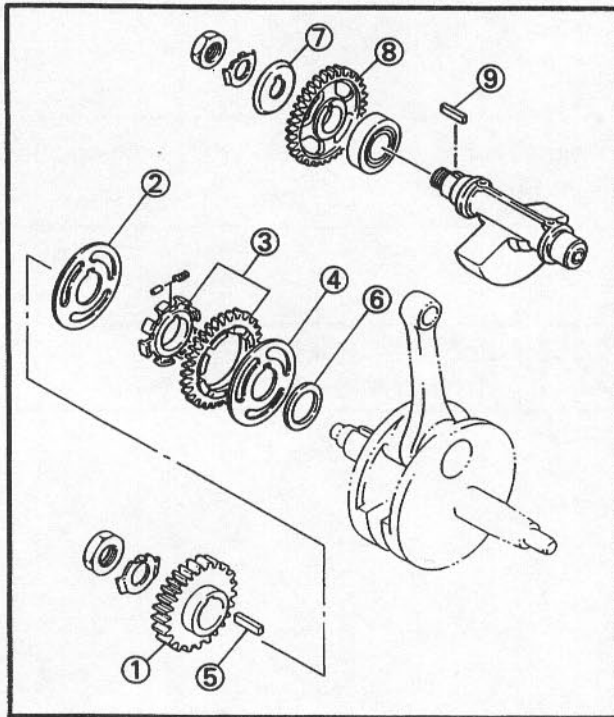
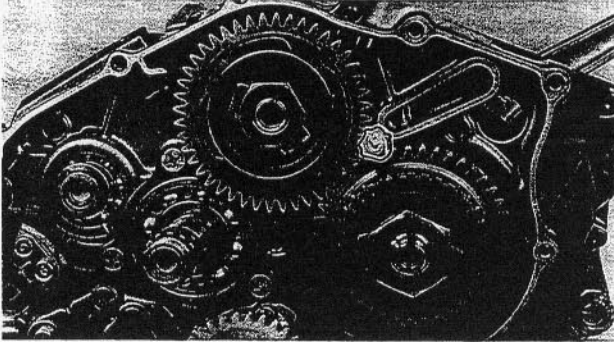
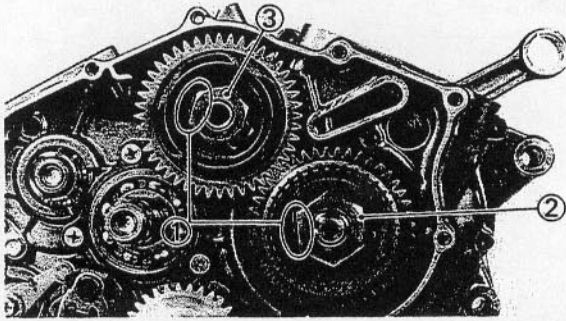

## 9. Straighten:

- Lock washer tabs ①

## 10. Loosen:

- Nut ② (crankshaft)
- Nut ③ (balancer shaft)

**NOTE:**

- Place a folded rag or aluminum plate between the teeth of the balancer drive gear and balancer gear.
- Take care not to damage the gear teeth.

## 11. Remove:

- Primary drive gear ①
- Plate ②
- Balancer drive gear ③
- Plate ④
- Key ⑤
- Plate washer ⑥
- Plate ⑦
- Balancer gear ⑧
- Key ⑨

**SHIFT LEVER AND OIL PUMP****NOTE:**

With the engine mounted, the oil pump can be maintained by removing the following parts.

- Clutch cable
- Engine guard
- Water pump housing
- Footrest (right)
- Brake pedal



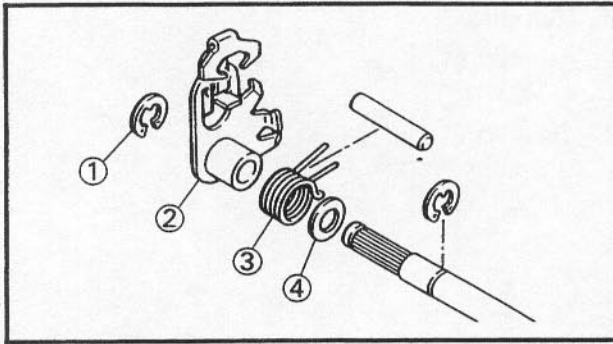

1. Remove:
- Circlip ①
  - Shift lever ②
  - Torsion spring ③
  - Washer ④

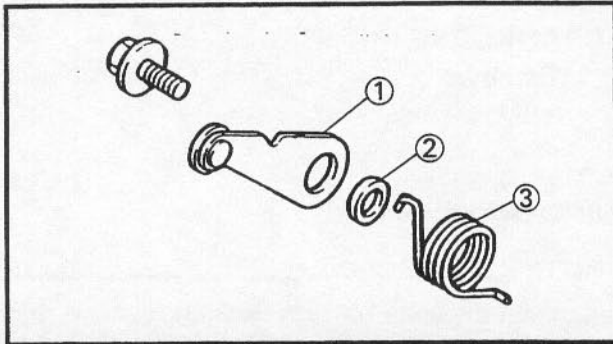

2. Remove:
- Stopper lever ①
  - Collar ②
  - Return spring ③

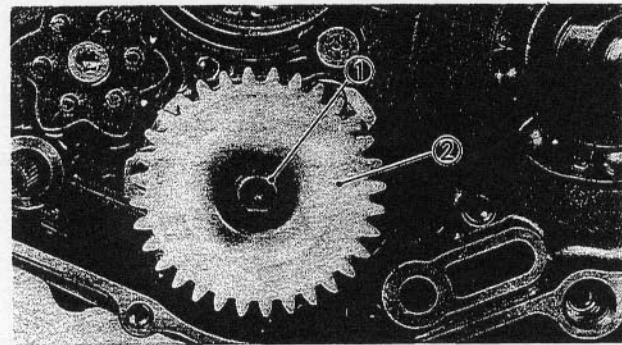

3. Remove:
- Circlip ①
  - Oil pump gear ②

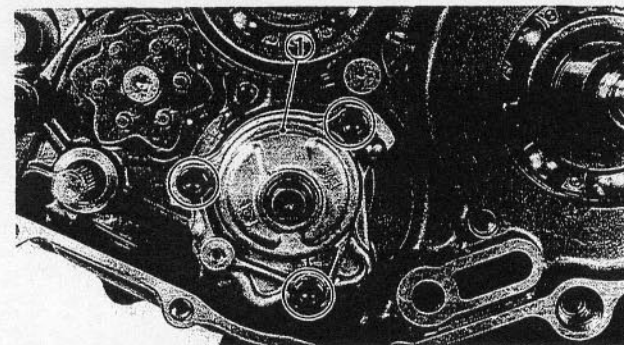

4. Remove:
- Oil pump assembly ①

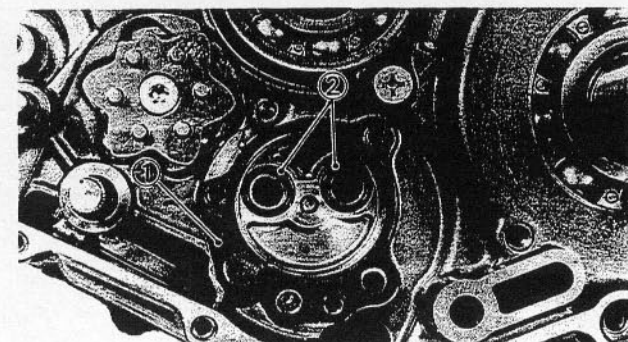

5. Remove:
- Gasket ①
  - O-rings ②

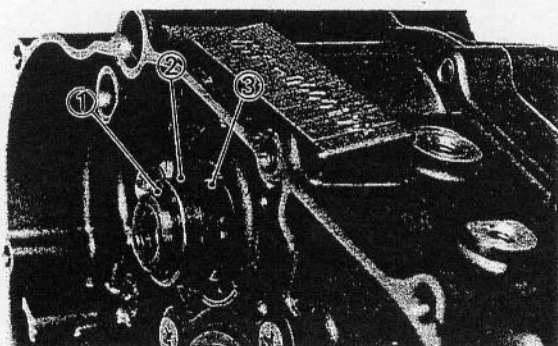

6. Remove:

- Circlip ①
- Collar ②
- Circlip ③

YB242009

## CRANKCASE (RIGHT)

1. Remove:

- Bolts (crankcase)

- A** Crankcase (right)
- B** Crankcase (left)

**NOTE:** \_\_\_\_\_

- Loosen the bolts 1/4 turn each and remove them after all are loosened.
- Loosen the bolts starting with the highest numbered one.
- The embossed numbers in the crankcase designate the tightening sequence.

**NOTE:** \_\_\_\_\_

Turn the shift cam to the position shown in the figure so that it does not contact the crankcase when separating the crankcase.

2. Attach:

- Crankcase separating tool ①



**Crankcase separating tool:**  
P/N. YU-01135-A, 90890-01135

3. Remove:

- Crankcase (right) ②

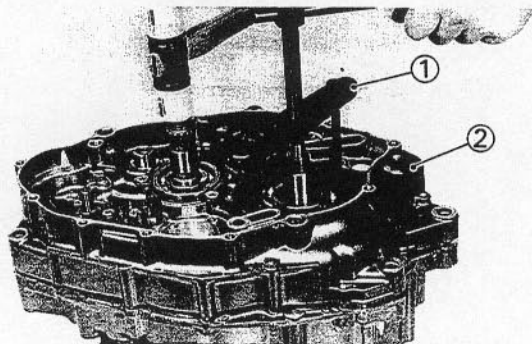
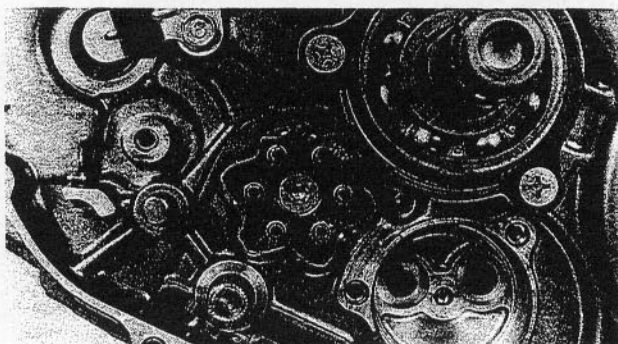
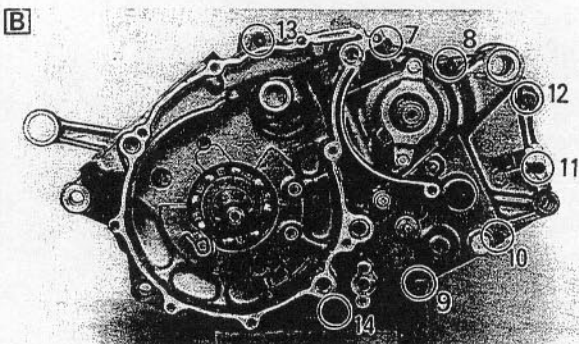
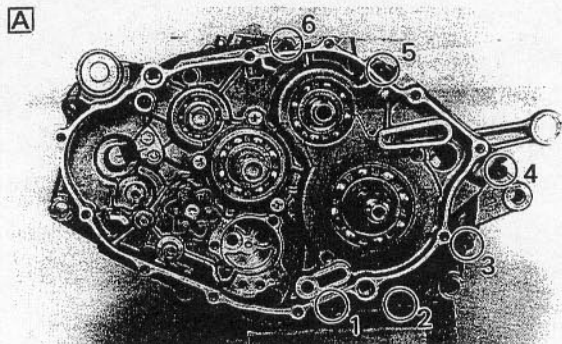

**NOTE:**

- Fully tighten the tool holding bolts, but make sure the tool body is parallel with the case. If necessary, one screw may be backed out slightly to level tool body.
- As pressure is applied, alternately tap on the front engine mounting boss, transmission shafts, and shift cam.

**CAUTION:**

Use soft hammer to tap on the case half. Tap only on reinforced portions of case. Do not tap on gasket mating surface. Work slowly and carefully. Make sure the case halves separate evenly. If one end "hangs up," take pressure off the push screw, realign, and start over. If the cases do not separate, check for a remaining case screw or fitting. Do not force.

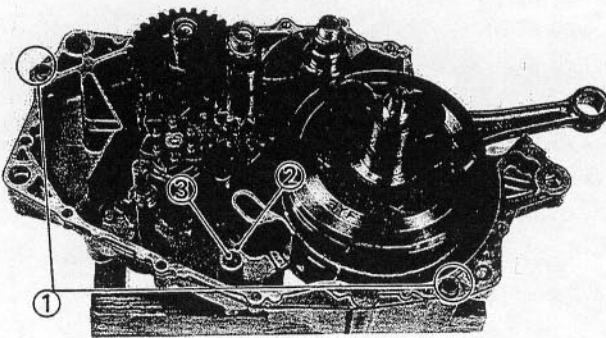

## 4. Remove:

- Dowel pins ①
- Dowel pin ②
- O-ring ③





## OIL STRAINER

1. Remove:

- Oil strainer ①
- Oil passage cover ②

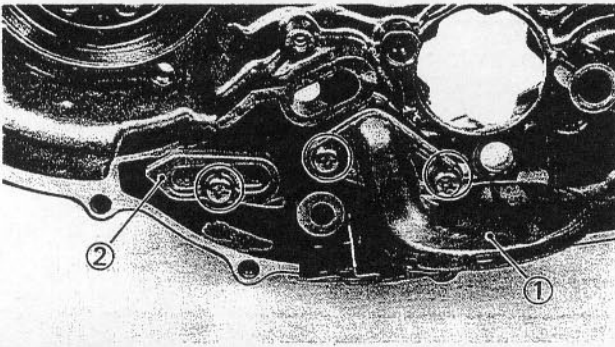

2. Remove:

- Gasket ① (oil strainer)

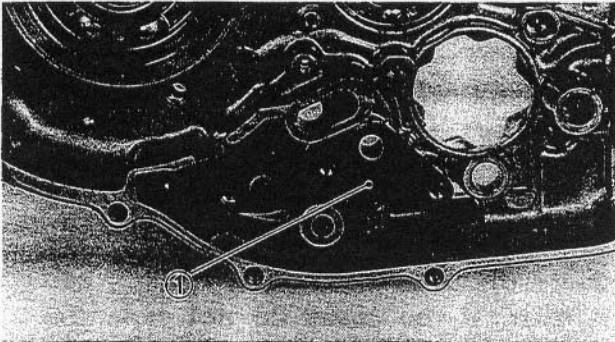

YB242010

## BALANCER, TRANSMISSION AND SHIFTER

1. Remove:

- Shift shaft ①
- Shift shaft 2 ②

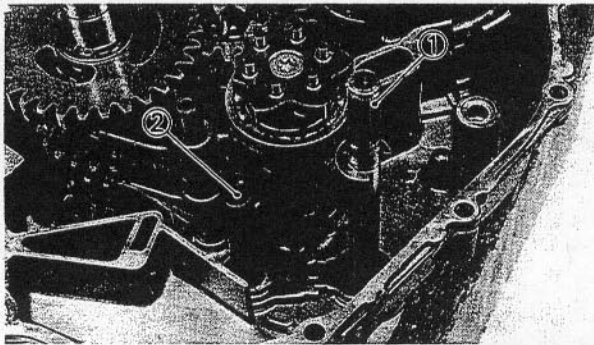

2. Remove:

- Guide bar ① (short)
- Guide bar ② (long)
- Shift cam ③
- Shift fork 2 "C" ④
- Shift fork 3 "R" ⑤
- Shift fork 1 "L" ⑥

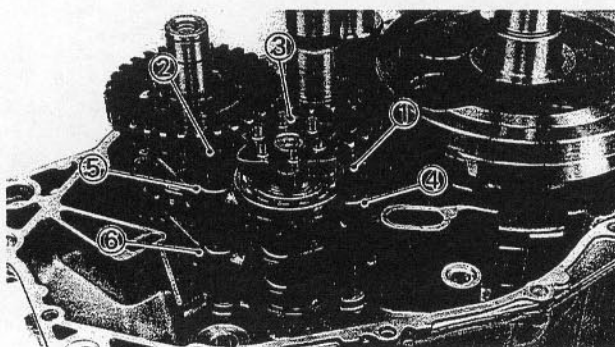

3. Remove:

- Main axle assembly ①

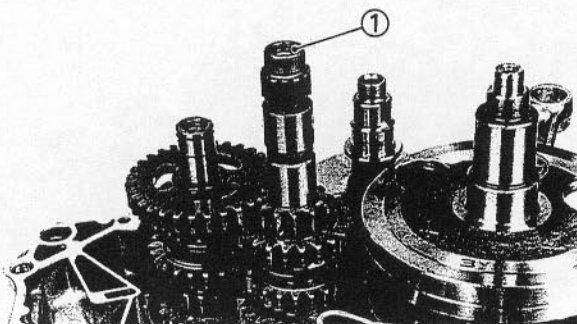

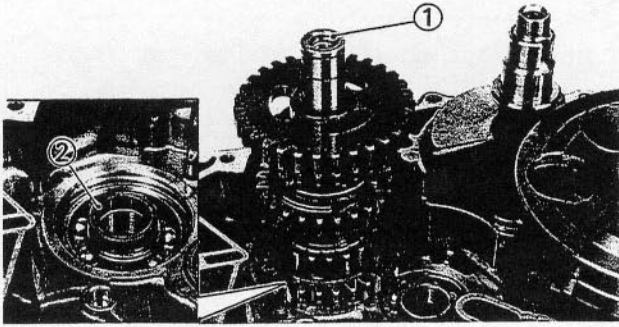

4. Remove:

- Drive axle assembly ①
- Collar ②

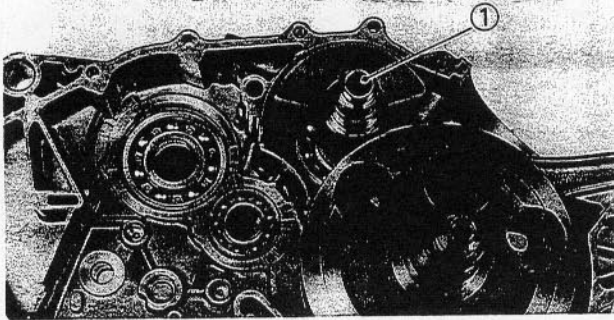

5. Remove:

- Balancer shaft ①

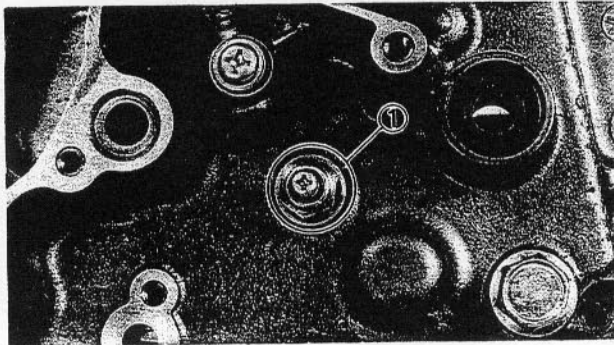

6. Remove:

- Neutral switch ①

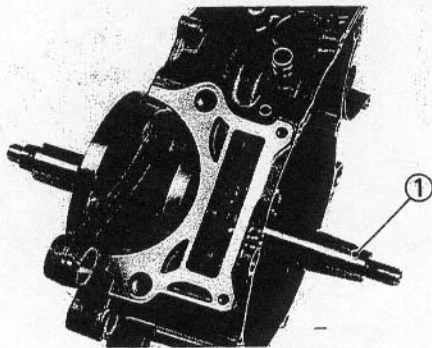

YB242011

### CRANKSHAFT

1. Remove:

- Crankshaft assembly ①
- Use the crankcase separating tool ② and adapter ③.



**Crankcase separating tool:**

**P/N. YU-01135-A, 90890-01135**

**Adapter:**

**P/N. YM-04063-A, 90890-04063**

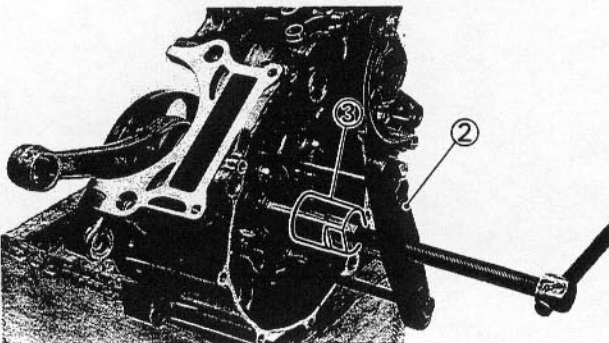

**NOTE:**

Tighten the tool holding bolts, but make sure that the tool body is vertical with the crankshaft. If necessary, one screw may be backed out slightly to level tool body.

**ROCKER ARM****NOTE:** \_\_\_\_\_

With the engine mounted, the rocker arm can be maintained by removing the following parts.

- Seat
- Side covers
- Air scoops
- Fuel tank
- Engine guard
- Radiator
- Exhaust pipes
- Ignition coil
- Oil tank breather hose
- Cylinder head cover

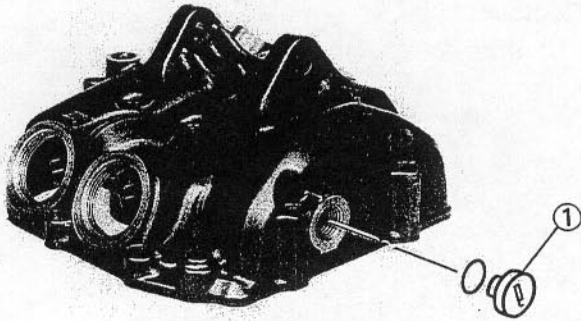

1. Remove:
- Plug ①

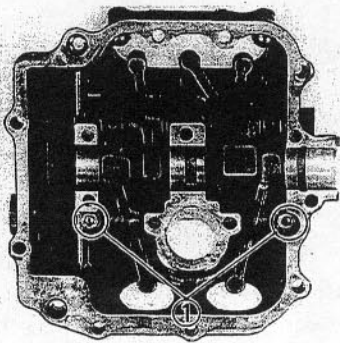

2. Remove:
- Bolt ① (rocker arm shaft)



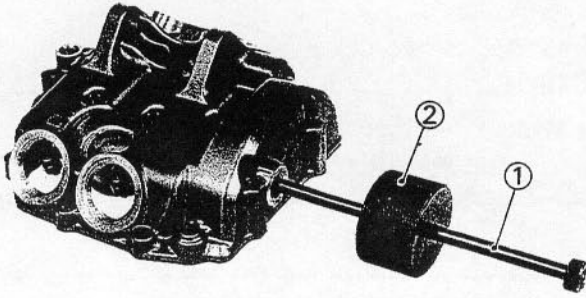

3. Remove:
  - Rocker arm shaft
  - Rocker arm

**NOTE:** \_\_\_\_\_  
 Remove the rocker arm shaft by the slide hammer bolt ① and weight ②.



**Slide hammer set:**  
 P/N. YU-01083-A  
**Slide hammer bolt:**  
 P/N. 90890-01083  
**Weight:**  
 P/N. 90890-01084

YB342012

## VALVES

**NOTE:** \_\_\_\_\_  
 Before removing the internal parts (valve, valve spring, valve seat etc.) of the cylinder head. The valve sealing should be checked.

1. Check:
  - Valve sealing  
 Leakage at valve seat→Inspect the valve face, valve seat and valve seat width.  
 Refer to the "INSPECTION AND REPAIR—VALVE SEAT".

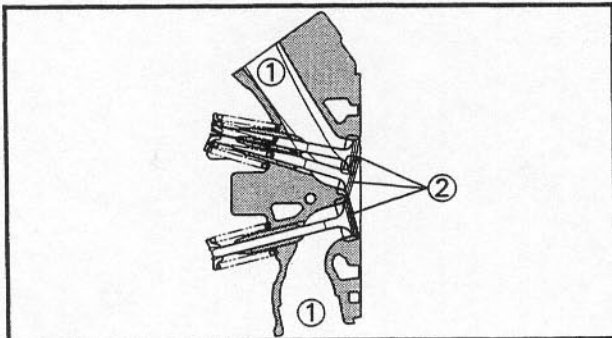

\*\*\*\*\*

### Checking steps:

- Pour a clean solvent ① into the intake and exhaust ports.
- Check the valve sealing.  
 There should be no leakage at the valve seat ②.

\*\*\*\*\*

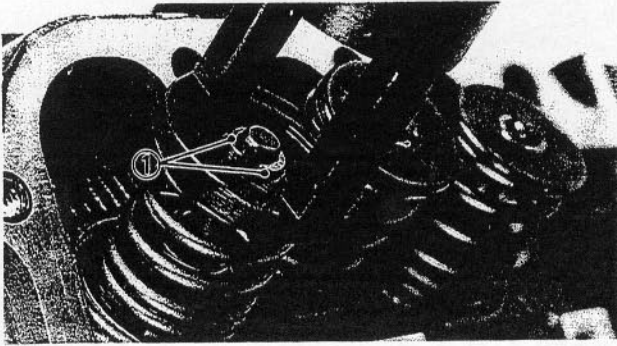

2. Remove:

- Valve cotters ①

**NOTE:**

Remove the valve cotters while compressing the valve spring with the valve spring compressor.



**Valve spring compressor:**

P/N. YM-04019, 90890-04019

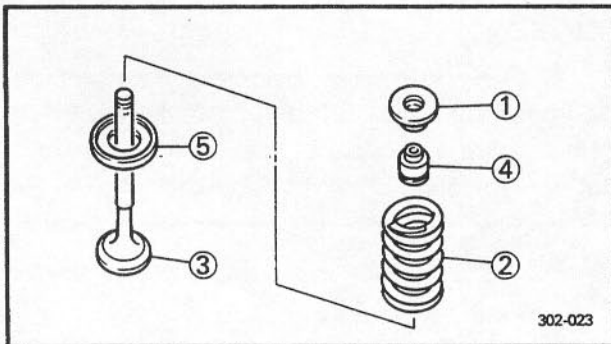

3. Remove:

- Valve retainers ①
- Valve spring ②
- Valve ③
- Oil seal ④
- Spring seat ⑤

**NOTE:**

Identify each part position very carefully so that it can be reinstalled in its original place.

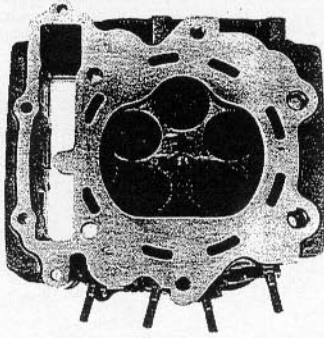

YB243001

**INSPECTION AND REPAIR  
CYLINDER HEAD**

1. Eliminate:
  - Carbon deposit  
(from combustion chamber)  
Use rounded scraper.

**NOTE:** \_\_\_\_\_

Do not use a sharp instrument and avoid damaging or scratching:

- Spark plug thread
- Valve seat

2. Inspect:
  - Cylinder head  
Scratches/Damage → Replace.
  - Water jacket  
Crust of minerals/Rust → Eliminate.

3. Measure:
  - Warpage  
Out of specification → Resurface.

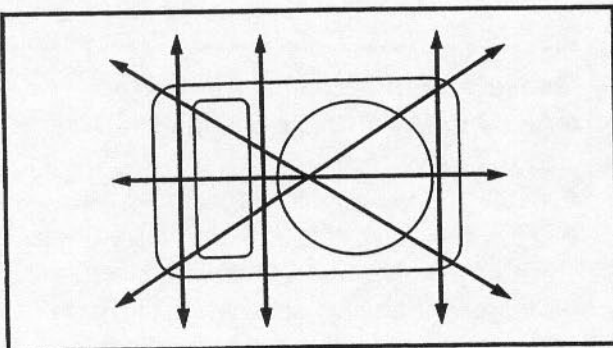

	<p><b>Cylinder head warpage:</b> Less than 0.03 mm (0.0012 in) -</p>
--	--

4. Resurface:
  - Cylinder head

\*\*\*\*\*

**Resurfacement steps:**

- Place a 400 ~ 600 grit wet sandpaper on the surface plate, and resurface the head using a figure-eight sanding pattern.



**NOTE:**

Rotate the head several times to avoid removing too much material from one side.

\*\*\*\*\*

YB243002

**VALVE SEAT****1. Eliminate:**

- Carbon deposit  
(from valve face and valve seat)

**2. Inspect:**

- Valve seat  
Pitting/Wear → Reface the valve seat.

**3. Measure:**

- Valve seat width (a)  
Out of specification → Reface the valve seat.

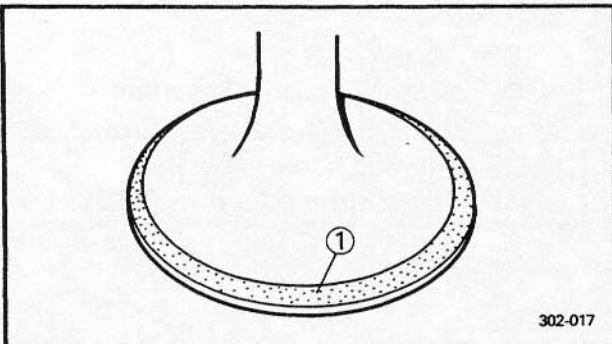
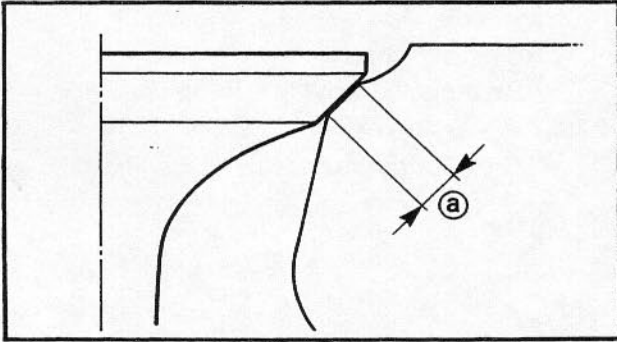

302-017

**Valve seat width:****Intake**

0.9 ~ 1.1 mm (0.035 ~ 0.043 in)

**Exhaust**

0.9 ~ 1.1 mm (0.035 ~ 0.043 in)

\*\*\*\*\*

**Measurement steps:**

- Apply the Mechanic's bluing dye (Dykem) ① to the valve face.
- Install the valve into the cylinder head.
- Press the valve through the valve guide and onto the valve seat to make a clear pattern.
- Measure the valve seat width. Wherever the valve seat and valve face made contact, bluing will have been removed.
- If the valve seat width is too wide, too narrow, or seat has not centered, the valve seat must be refaced.

\*\*\*\*\*

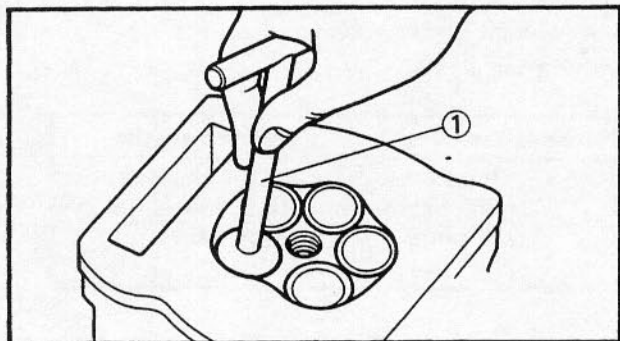

4. Reface:

- Valve seat

Use a 30°, 45° and 60° valve seat cutter ①.



Valve seat cutter:  
P/N. YM-91043

**CAUTION:**

When twisting cutter, keep an even downward pressure (4~5 kg) to prevent chatter marks.

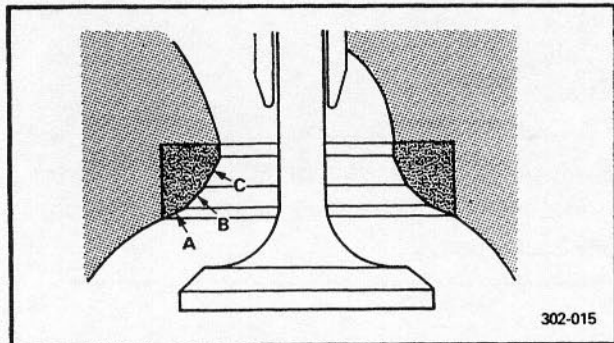

Cut section as follows	
Section	Cutter
A	30°
B	45°
C	60°

\*\*\*\*\*

**Refacing steps:**

- A** Valve seat is centered on valve face but it is too wide.

Valve seat cutter set		Desire result
Use lightly	30° cutter 60° cutter	To reduce valve seat width to 1.0 mm (0.039 in).

- B** Valve seat is in the middle of the face but it is too narrow.

Valve seat cutter set		Desired result
Use	45° cutter	To achieve a uniform valve seat width of 1.0 mm (0.039 in).

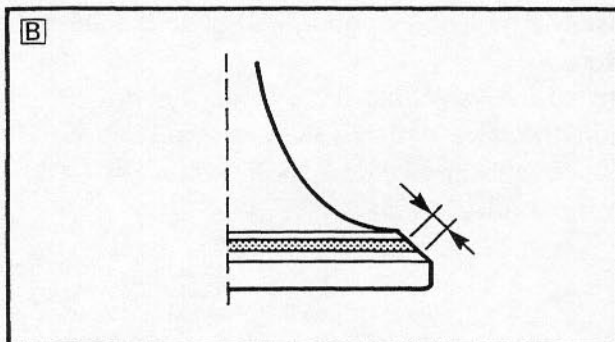
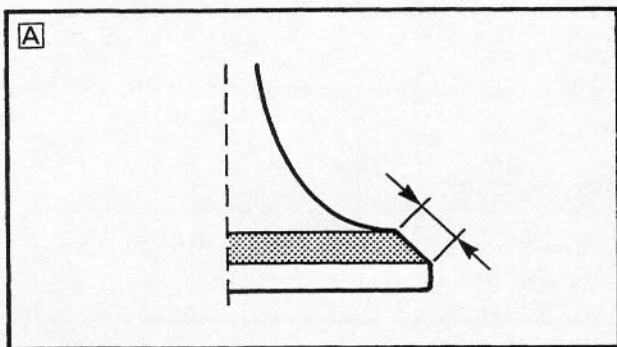

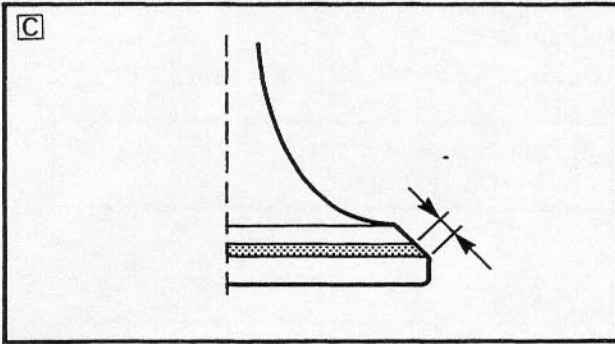

C Valve seat is too narrow and it is near valve margin.

Valve seat cutter set		Desired result
Use	First: 30° cutter Second: 45° cutter	To center the seat and to achieve its width of 1.0 mm (0.039 in).

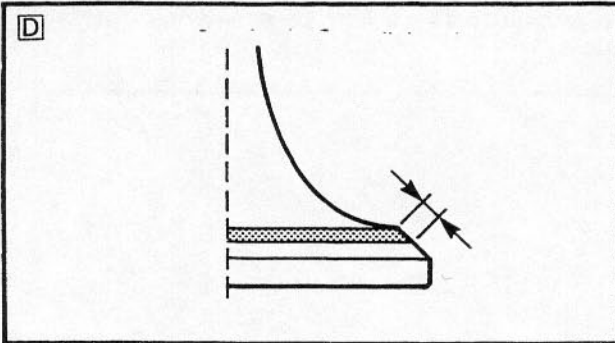

D Valve seat is too narrow and it is located near the bottom edge of the valve face.

Valve seat cutter set		Desired result
Use	First: 60° cutter Second: 45° cutter	To center the seat and increase its width.

\*\*\*\*\*

5. Lap:

- Valve face
- Valve seat

NOTE: \_\_\_\_\_

After refacing the valve seat or replacing the valve and valve guide, the valve seat and valve face should be lapped.

\_\_\_\_\_

\*\*\*\*\*

Lapping steps:

- Apply a coarse lapping compound to the valve face.

CAUTION: \_\_\_\_\_

Be sure no compound enters the gap between the valve stem and guide.

\_\_\_\_\_

- Apply a molybdenum disulfided oil to the valve stem.
- Install the valve into the cylinder head.
- Turn the valve until the valve face and valve seat are evenly polished, then clean off all compound.

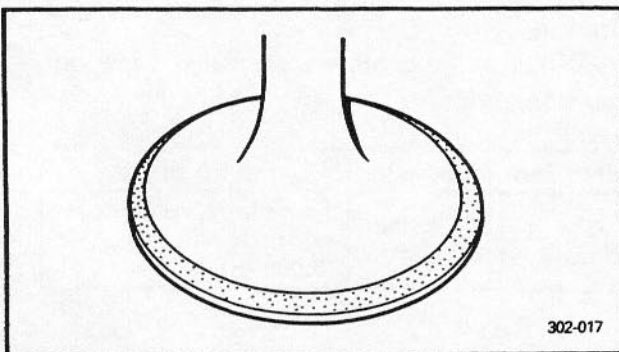

302-017

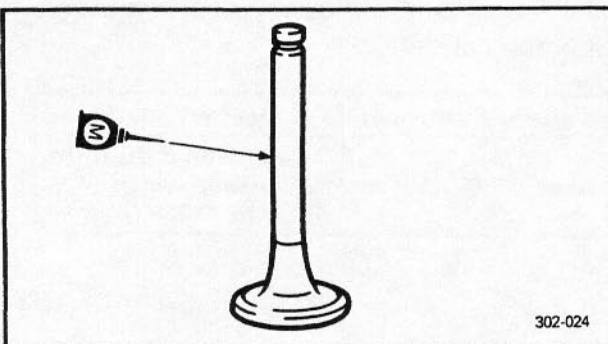

302-024



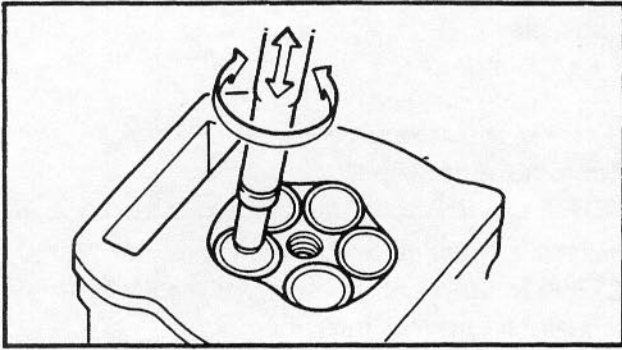

**NOTE:** \_\_\_\_\_

To obtain the best lapping results, lightly tap the valve seat while rotating the valve back and forth between your hands.

- Apply fine lapping compound to the valve face and repeat the above steps.

**NOTE:** \_\_\_\_\_

Be sure to clean off all compound from the valve face and valve seat after every lapping operation.

- Apply a Mechanic's bluing dye (Dykem) to the valve face.
- Install the valve into the cylinder head.
- Press the valve through the valve guide and onto the valve seat to make a clear pattern.
- Measure the valve seat width again.  
If the valve seat width out of specification, reface and lap the valve seat.

\*\*\*\*\*

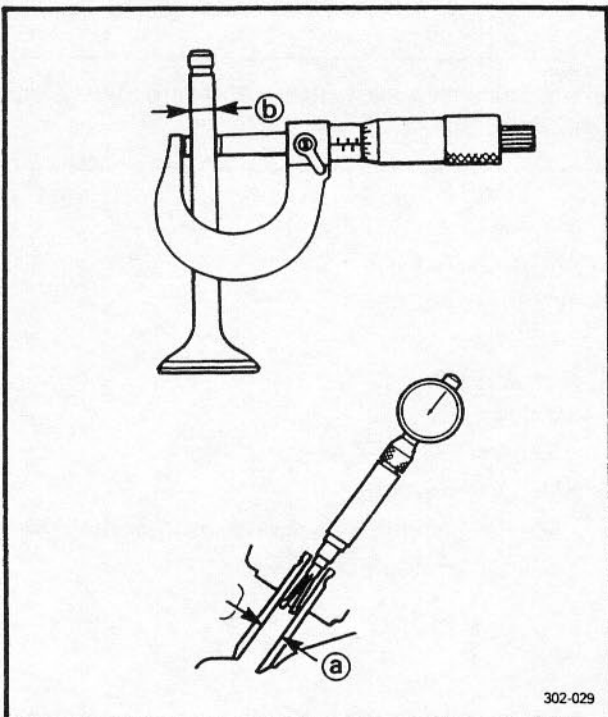

YB243003

**VALVE AND VALVE GUIDE**

1. Measure:

- Stem-to-guide clearance

$$\text{Stem-to-guide clearance} = \text{Valve guide inside diameter (a)} - \text{Valve stem diameter (b)}$$

Out of specification → Replace valve guide.

**Stem-to-guide clearance:**

**Intake:**  
 0.010 ~ 0.037 mm  
 (0.0004 ~ 0.0014 in)  
 < Limit > : 0.08 mm (0.0031 in)

**Exhaust:**  
 0.025 ~ 0.052 mm  
 (0.001 ~ 0.002 in)  
 < Limit > : 0.10 mm (0.0039 in)

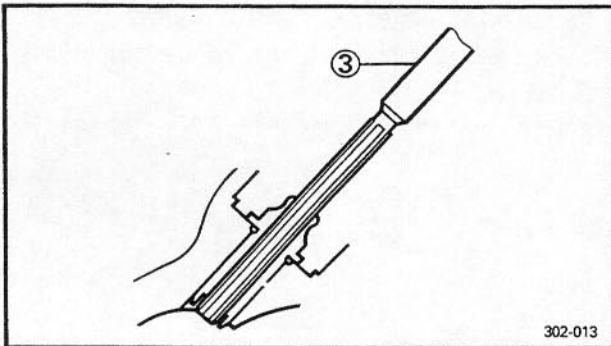
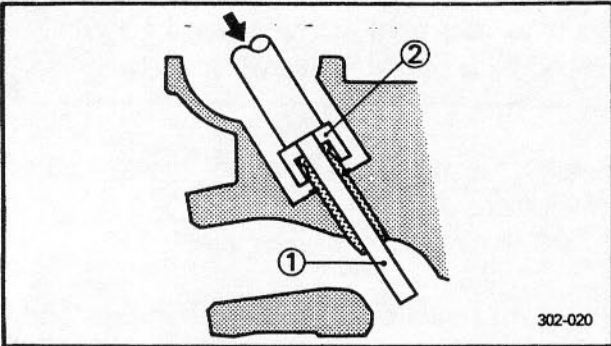
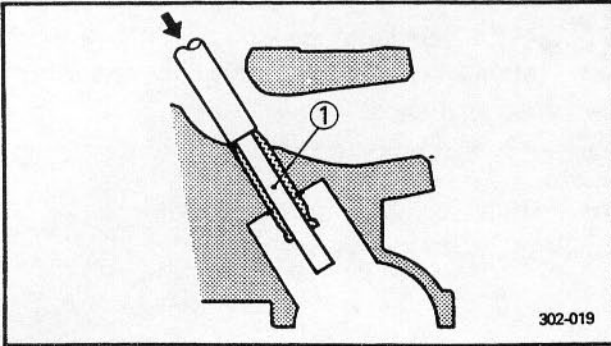

2. Replace:
- Valve guide

\*\*\*\*\*

**Replacement steps:**

**NOTE:** \_\_\_\_\_

Heat the cylinder head in an oven to 100°C (212°F) to ease guide removal and installation and to maintain correct interference fit.

- Remove the valve guide using the valve guide remover ①.
- Install the valve guide (new) using the valve guide installer ② and valve guide remover ①.
- After installing the valve guide, bore the valve guide using the valve guide reamer ③ to obtain proper stem-to-guide clearance.



**Valve guide remover 6 mm (0.24 in):**

**P/N. YM-04064-A, 90890-04064**

**Valve guide reamer 6 mm (0.24 in):**

**P/N. YM-04066, 90890-04066**

**Valve guide installer 6 mm (0.24 in):**

**P/N. YM-04065-A, 90890-04065**

\*\*\*\*\*

**NOTE:** \_\_\_\_\_

Reface the valve seat after replacing the valve guide.

3. Eliminate:
- Carbon deposit (from valve face)
4. Inspect:
- Valve face  
Pitting/Wear → Grind the face.
  - Valve stem end  
Mushroom shape or diameter larger than rest of stem → Replace.

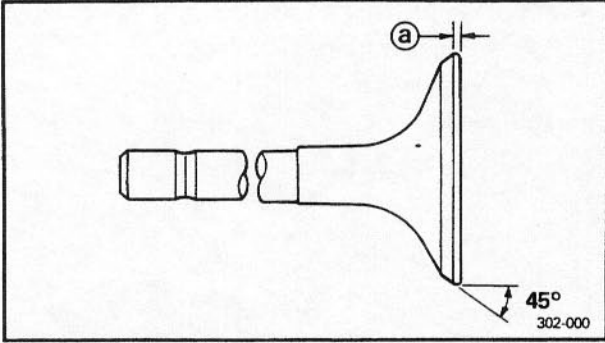

5. Measure:

- Margin thickness (a)  
Out of specification → Replace.



**Margin thickness:**  
Limit: 0.8 mm (0.032 in)

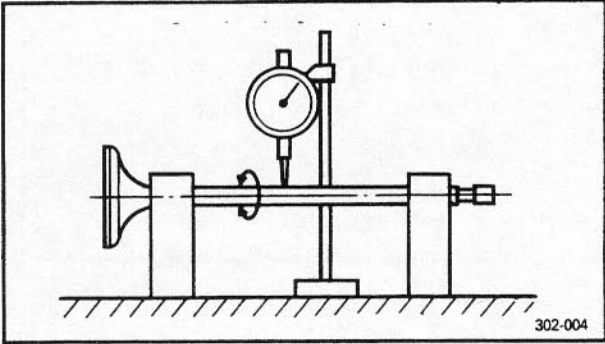

6. Measure:

- Runout (valve stem)  
Out of specification → Replace.



**Runout:**  
Less than 0.01 mm (0.0004 in)

**NOTE:** \_\_\_\_\_

- Always replace the guide if the valve is replaced.
- Always replace the oil seal if the valve is removed.

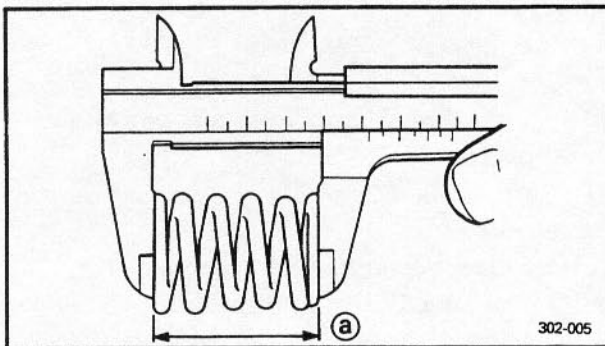

YB243004

## VALVE SPRING

1. Measure:

- Free length (a) (valve spring)  
Out of specification → Replace.



**Free length (valve spring):**  
Intake:  
32.63 mm (1.285 in)  
Exhaust:  
36.46 mm (1.435 in)



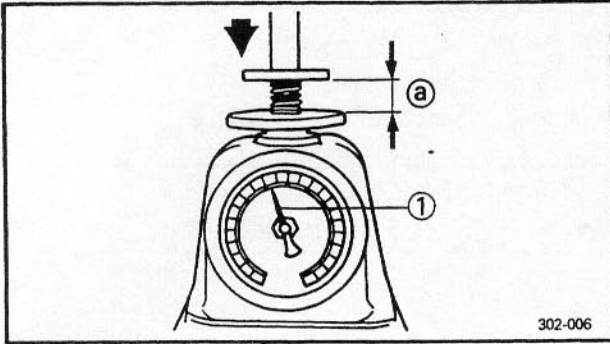

2. Measure:
- Compressed force (valve spring) ①
- Out of specification → Replace.

① Installed length



**Compressed force:**

**Intake:**

10.2 ~ 11.8 kg (22.49 ~ 26.01 lb)  
at 27.50 mm (1.083 in)

**Exhaust:**

12.3 ~ 14.1 kg (27.12 ~ 31.08 lb)  
at 31.00 mm (1.220 in)

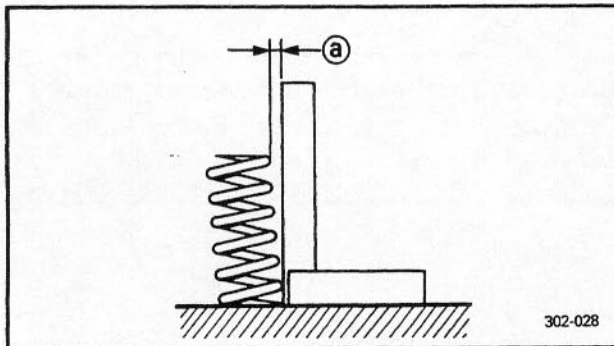

3. Measure:
- Spring tilt ②
- Out of specification → Replace.



**Spring tilt:**

**Intake:**

Less than 1.4 mm (0.055 in)

**Exhaust:**

Less than 1.6 mm (0.063 in)

YB243005

**CAMSHAFT**

1. Inspect:
- Cam lobes
- Pitting/Scratches/Blue discoloration → Replace.

2. Measure:
- Com lobes length ③ and ④
- Out of specification → Replace.

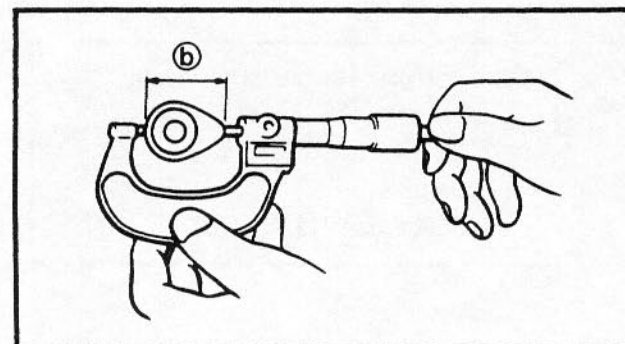
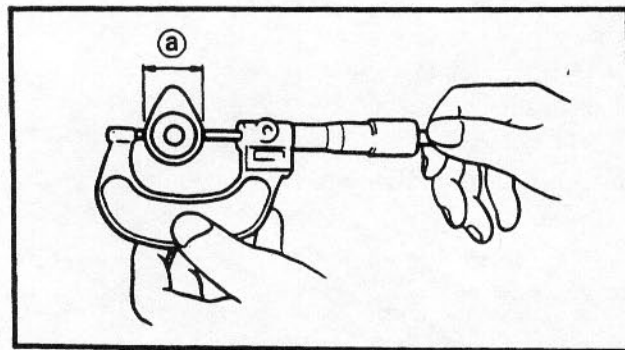

**Cam lobes length:**

**Intake:**

③ 30.06 ~ 30.16 mm  
(1.1835 ~ 1.1874 in)

④ 35.69 ~ 35.79 mm  
(1.4051 ~ 1.4091 in)

**Cam lobes length:****Exhaust:**

- Ⓐ 30.11 ~ 30.21 mm  
(1.1854 ~ 1.1894 in)
- Ⓑ 36.50 ~ 36.60 mm  
(1.4370 ~ 1.4409 in)

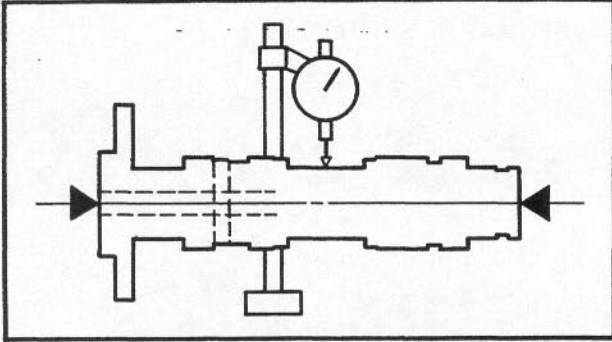
**3. Measure:**

- Runout (camshaft)
- Out of specification → Replace.

**Runout (camshaft):**

Less than 0.03 mm (0.0012 in)

**4. Measure:**

- Camshaft-to-cap clearance
- Out of specification → Measure bearing diameter (camshaft).

**Camshaft-to-cap clearance:**

0.020 ~ 0.054 mm  
(0.0008 ~ 0.0021 in)

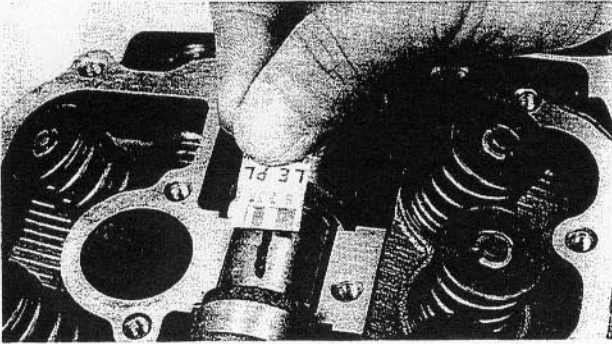

\*\*\*\*\*

**Measurement steps:**

- Install the camshaft onto the cylinder head.
- Position a strip of Plastigauge® onto the camshaft.
- Install the dowel pins and cylinder head cover.

**Bolt (cylinder head cover):**

10 Nm (1.0 m•kg, 7.2 ft•lb)

**NOTE:**

- Tighten the bolts (cylinder head cover) in a criss-cross pattern from innermost to outer.
- Do not turn the camshaft when measuring clearance with the Plastigauge®.

- Remove the cylinder head cover and measure width of the Plastigauge®.

\*\*\*\*\*

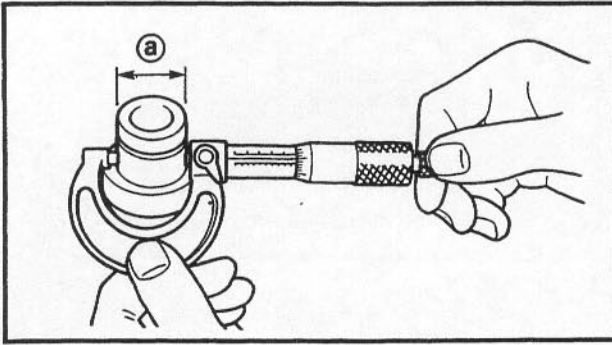

## 5. Measure:

- Bearing diameter (a) (camshaft)  
Out of specification → Replace camshaft.  
Within specification → Replace cylinder head.



**Bearing diameter (camshaft):**  
22.967 ~ 22.980 mm  
(0.9042 ~ 0.9047 in)

YB243006

**DECOMPRESSION**

## 1. Inspect:

- Spring (1)  
Damage → Replace
- Decompression pin (2)
- Decompression lever (3)
- Decompression cam (4)  
Damage/Bends/Wear → Replace.

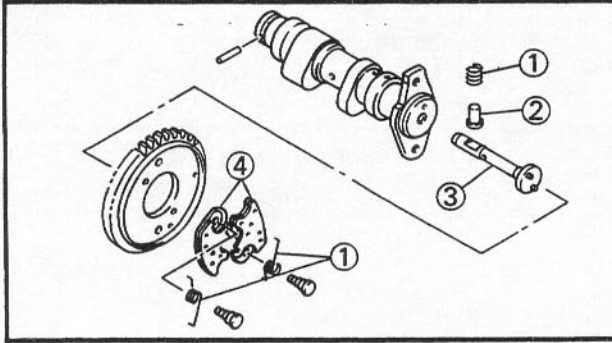

## 2. Check:

- Decompression play  
Play exists → Replace.

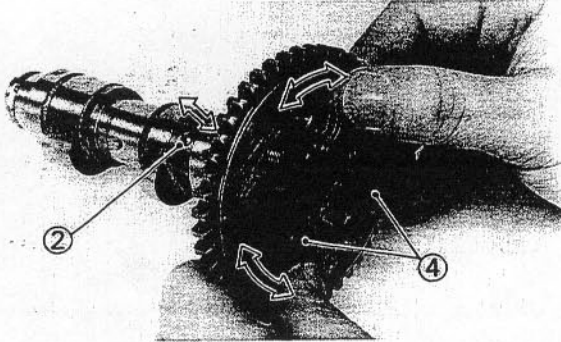
**ROCKER ARM AND ROCKER ARM SHAFT**

## 1. Inspect:

- Rocker arm shaft  
Blue discoloration/Grooves → Replace, then inspect lubrication system.

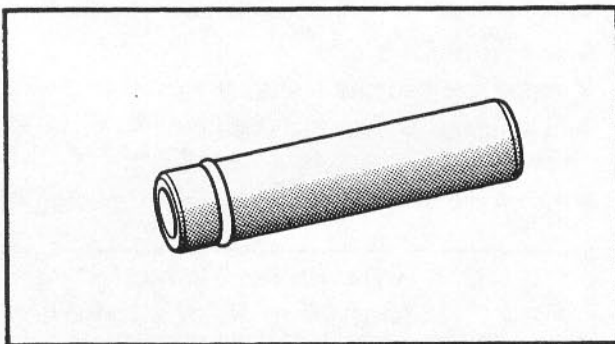

## 2. Inspect:

- Rocker arm shaft hole (1)
- Cam lobe contact surface (2)
- Adjuster surface (3)  
Wear/Pitting/Scratches/Blue discoloration  
→ Replace, then inspect lubrication system.

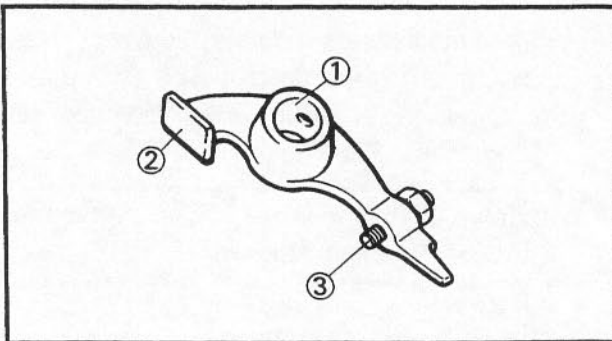



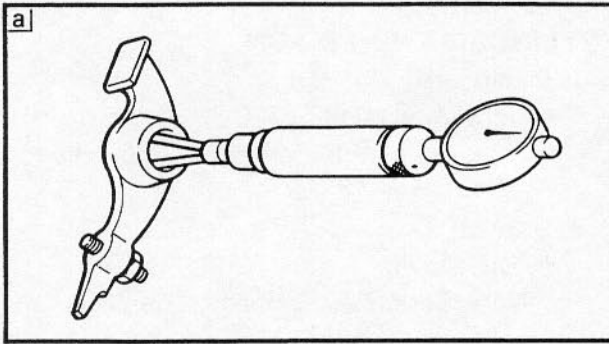

### 3. Measure:

- Arm-to-shaft clearance.

Arm-to-shaft clearance =

Rocker arm inside diameter (a) –

Rocker arm shaft outside diameter (b)

Out of specification → Replace as a set.

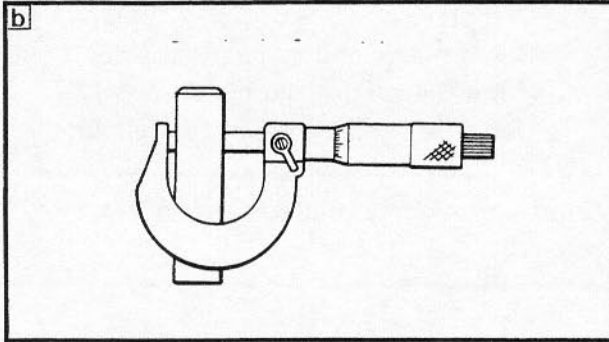

### Arm-to-shaft clearance:

0.009 ~ 0.042 mm

(0.0004 ~ 0.0020 in)

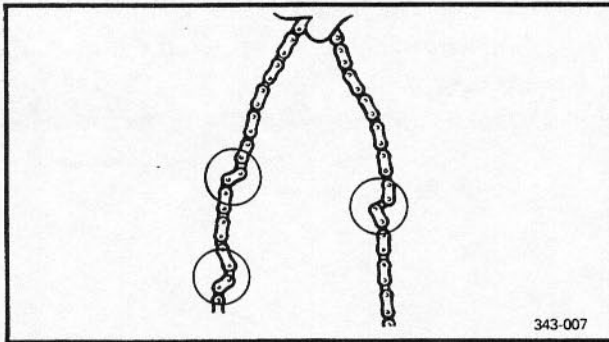

YB243007

## TIMING CHAIN, SPROCKET AND CHAIN GUIDE

### 1. Inspect:

- Timing chain

Stiff/Cracks → Replace timing chain and sprocket as a set.

### 2. Inspect:

- Cam sprocket

Wear/Damage → Replace cam sprocket and timing chain as a set.

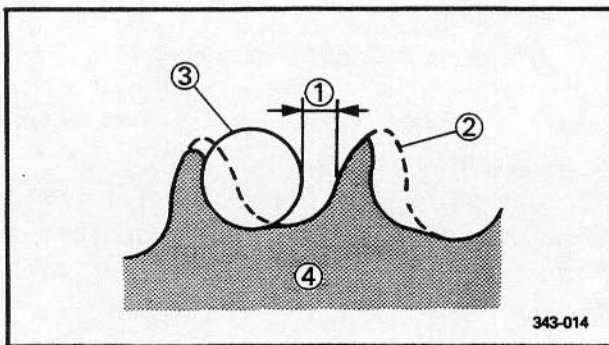

- ① 1/4 tooth
- ② Correct
- ③ Roller
- ④ Sprocket

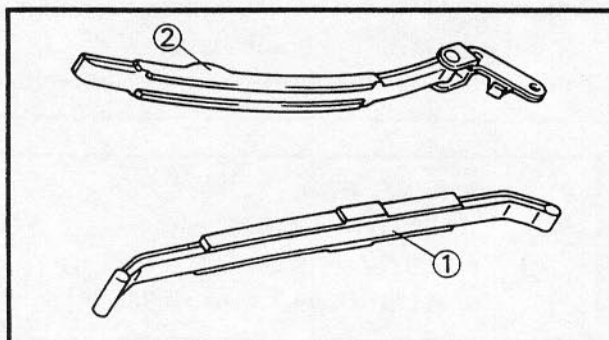

### 3. Inspect:

- Chain guide ① (exhaust side)
- Chain guide ② (intake side)

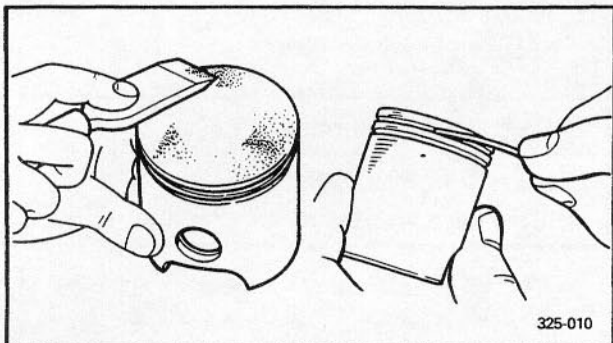

YB243008

## CYLINDER AND PISTON

1. Eliminate:
  - Carbon deposits  
(from the piston crown and ring grooves.)
2. Inspect:
  - Piston wall  
Wear/Scratches/Damage → Replace.
3. Eliminate:
  - Score marks and lacquer deposits  
(from the side of the piston.)  
Use a 600~800 grit wet sandpaper.

**NOTE:** \_\_\_\_\_  
Sand in a crisscross pattern. Do not sand excessively.

---

4. Inspect:
  - Cylinder water jacket  
Crust of minerals/Rust → Remove.
  - Cylinder wall  
Wear/Scratches → Rebore or replace.

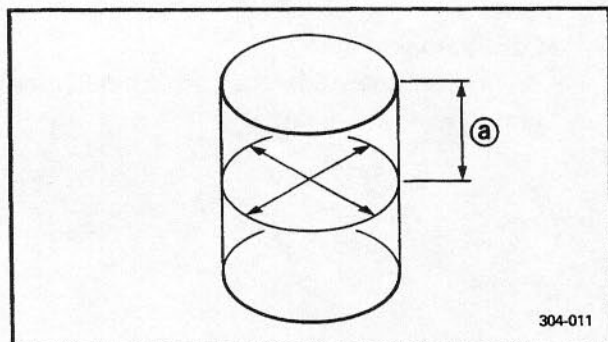

5. Measure:
  - Piston-to-cylinder clearance

\*\*\*\*\*

### Measurement steps:

#### First steps

- Measure the cylinder bore "C" with a cylinder bore gauge.
- ① 50 mm (1.97 in) from the cylinder top

**NOTE:** \_\_\_\_\_  
Measure the cylinder bore "C" in parallel to and at right angles to the crankshaft.  
Then, find the average of the measurements.

---



### Cylinder bore "C":

100.005 ~ 100.045 mm

(3.9372 ~ 3.9388 in)

< Limit: 100.1 mm (3.941 in) >

$$C = (X + Y) / 2$$

- If out of the specification, rebore or replace the cylinder, and the piston and piston rings as a set.

**2nd steps**

- Measure the piston skirt diameter "P" with a micrometer.
- ② 2.5 mm (0.098 in) from the piston bottom edge

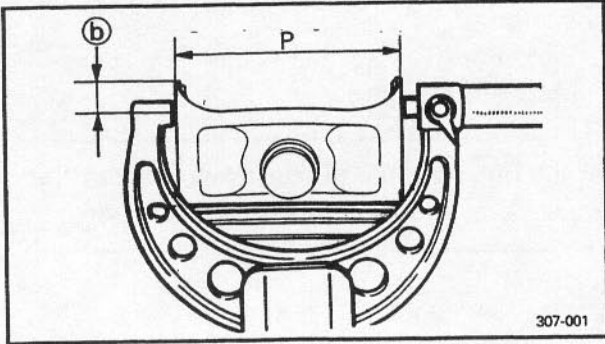



**Piston skirt diameter "P":**  
 99.945 ~ 99.985 mm  
 (3.935 ~ 3.936 in)

- If out of the specification, replace the piston and piston ring as a set.

**3rd steps**

- Find the piston-to-cylinder clearance with following formula.

**Piston-to-cylinder clearance =**  
**Cylinder bore "C" –**  
**Piston skirt diameter "P"**



**Piston-to-cylinder clearance:**  
 0.050 ~ 0.070 mm  
 (0.0020 ~ 0.0028 in)  
 < Limit: 0.15 mm (0.0059 in) >

- If out of the specification, rebore or replace the cylinder, and replace the piston and piston ring as a set.

\*\*\*\*\*

YB243009

**PISTON RING**

**1. Measure:**

- Side clearance  
 Out of specification → Replace piston and piston ring as a set.

**NOTE:** \_\_\_\_\_

Clean carbon from piston ring grooves and rings before measuring side clearance.

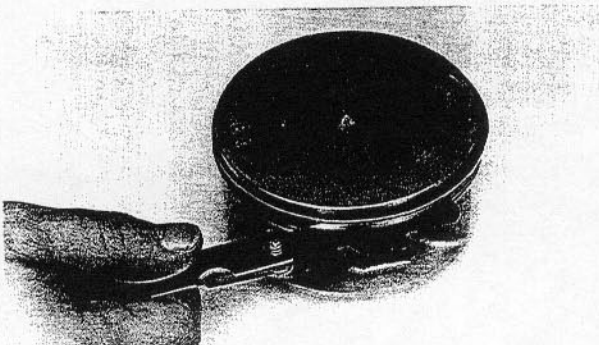



**Side clearance:****Top ring:**

0.04 ~ 0.08 mm  
(0.002 ~ 0.003 in)

**2nd ring:**

(0.03 ~ 0.07 mm)  
(0.001 ~ 0.003 in)

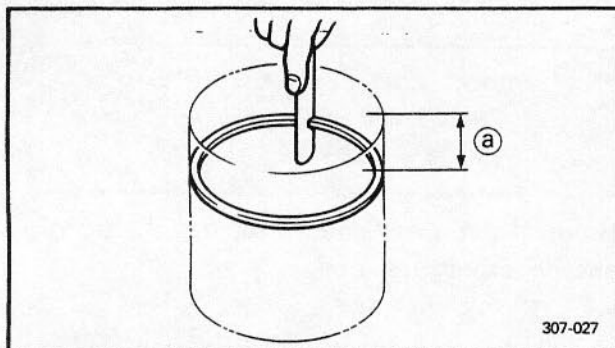
**2. Position:**

- Piston ring  
(into the cylinder)

**NOTE:**

Push the ring with the piston crown so that the ring will be at a right angle to cylinder bore.

Ⓐ 20 mm (0.8 in)

**3. Measure:**

- End gap  
Out of specification → Replace.

**NOTE:**

You cannot measure end gap on expander spacer of oil control ring. If oil control ring rails show excessive gap, replace all three rings.

**End gap:****Top ring:**

0.30 ~ 0.45 mm  
(0.012 ~ 0.018 in)

**2nd ring:**

0.30 ~ 0.45 mm  
(0.012 ~ 0.018 in)

**Oil ring:**

0.2 ~ 0.7 mm (0.008 ~ 0.018 in)

YB243010

**PISTON PIN****1. Inspect:**

- Piston pin  
Blue discoloration/groove → Replace, then inspect lubrication system.

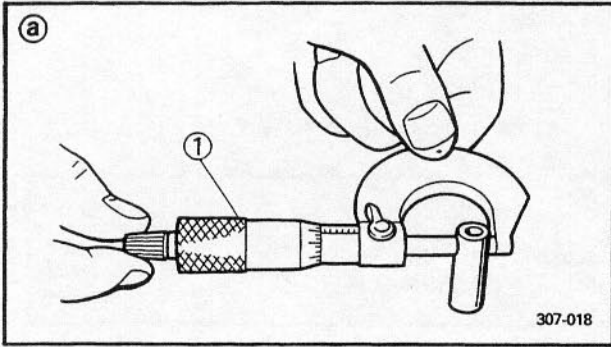

2. Measure:

- Piston pin-to-piston clearance

\*\*\*\*\*

**Measurement steps:**

- Measure the piston pin outside diameter (a).  
If out of specification, replace the piston pin.

**Outside diameter (piston pin):**  
 21.991 ~ 22.000 mm  
 (0.8658 ~ 0.8661 in)

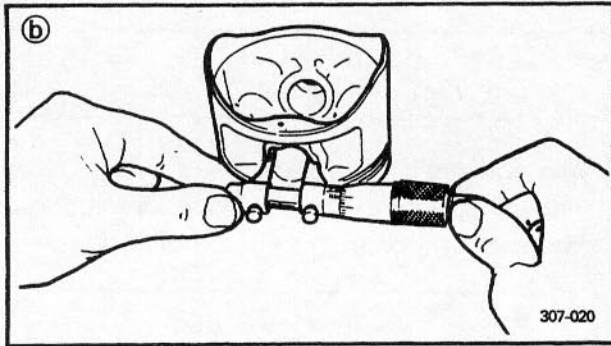

- Measure the piston inside diameter (b).
- Calculate the piston pin-to-piston clearance with following formula:

**Piston pin-to-piston clearance =**  
 Bore size (piston) (b) –  
 Outside diameter (piston pin) (a)

- If out of specification, replace the piston.

**Piston pin-to-piston clearance:**  
 0.004 ~ 0.024 mm  
 (0.0002 ~ 0.0009 in)  
 Limit: 0.07 mm (0.003 in)

\*\*\*\*\*

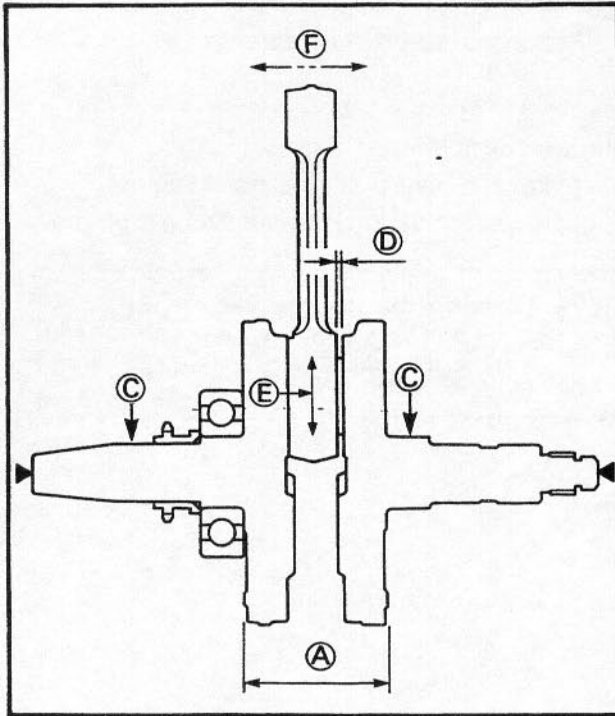

**CRANKSHAFT**

1. Measure:

- Crank width (A)  
Out of specification → Replace crankshaft.

 **Crank width:**  
74.95 ~ 75.00 mm  
(2.951 ~ 2.953 in)

- Runout (C)  
Out of specification → Replace crankshaft and/or bearing.

 **Runout limit:**  
0.03 mm (0.001 in)

- Small end free play (D)  
Out of specification → Replace big end bearing, crank pin and/or connecting rod.

 **Small end free play:**  
0.8 mm (0.031 in)

- Big end radial clearance (E)  
Out of specification → Replace connecting rod, big end bearing and/or crank pin.

 **Big end radial clearance:**  
0.01 ~ 0.025 mm  
(0.0004 ~ 0.0010 in)

- Side clearance (F)  
Out of specification → Replace connecting rod.

 **Big end side clearance:**  
0.35 ~ 0.65 mm (0.014 ~ 0.026 in)

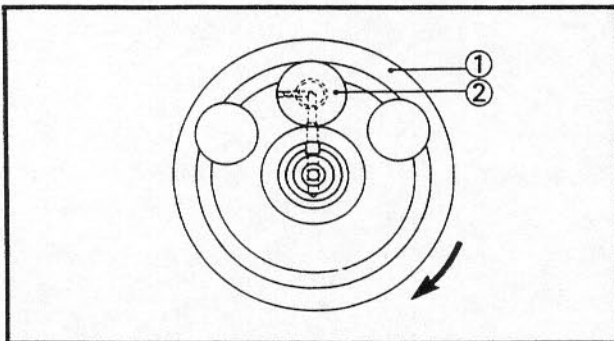

\*\*\*\*\*

**Crankshaft reassembling point:**

The crankshaft (1) and the crank pin (2) oil passages must be properly interconnected with a tolerance of less than 1 mm (0.04 in).

\*\*\*\*\*





**BALANCER DRIVE GEAR AND BALANCER GEAR**

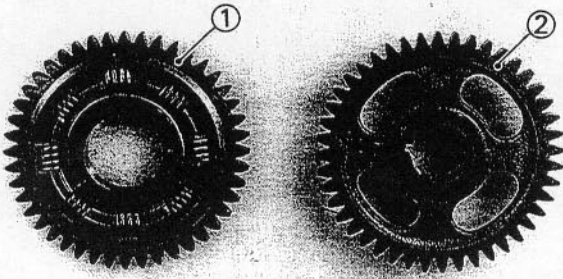

1. Inspect:

- Balancer drive gear teeth (1)
  - Balancer gear teeth (2)
- Wear/Damage → Replace both gears.

2. Check:

- Match marks (1)
- If they are not aligned → Align match marks as shown.

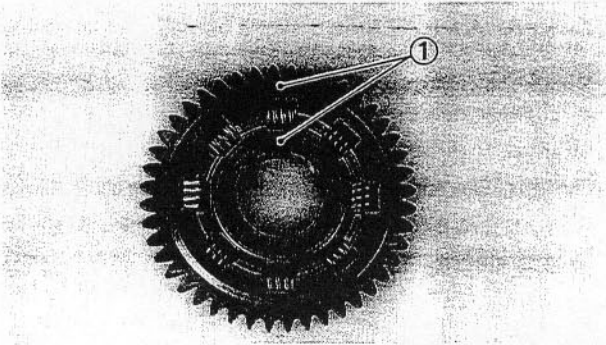

YB243012

**ELECTRIC STARTER DRIVE**

1. Inspect:

- Starter idle gear 1 teeth (1)
  - Starter idle gear 2 teeth (2)
  - Starter wheel gear teeth (3)
- Burrs/Chips/Roughness/Wear → Replace.

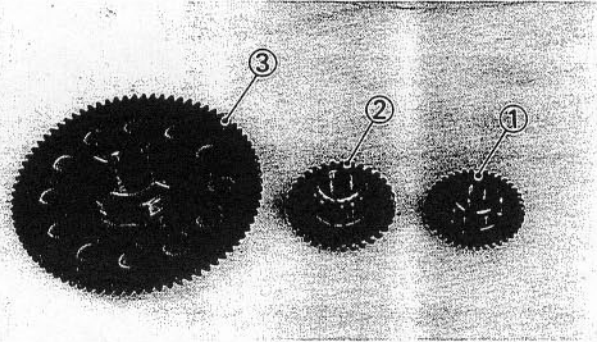

2. Inspect:

- Starter wheel gear (contacting surfaces)
- Pitting/Wear/Damage → Replace.

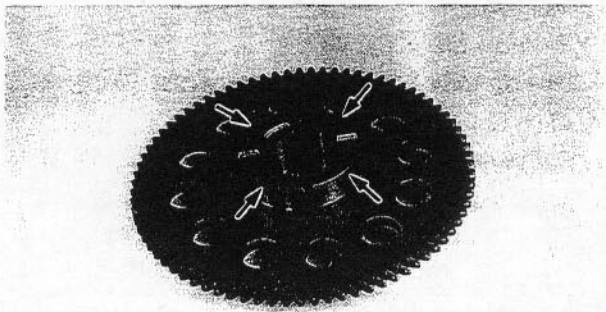

3. Check:

- Starter clutch operation

\*\*\*\*\*

**Checking steps:**

- Install the starter wheel gear to the starter clutch, and hold the starter clutch.
- When turning the starter wheel gear clockwise **A**, the starter clutch and the wheel gear should be engaged.

If not, the starter clutch is faulty. Replace it.

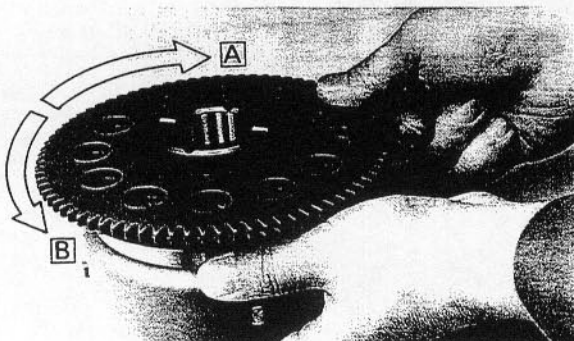



- When turning the starter wheel gear counter-clockwise [B], the starter clutch gear should turn freely.

If not, the starter clutch is faulty. Replace it.

\*\*\*\*\*

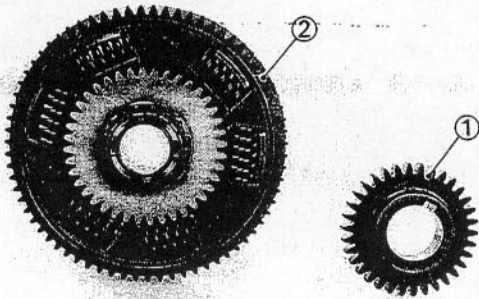

YB243013

**PRIMARY DRIVE**

1. Inspect:

- Primary drive gear teeth ①
- Primary driven gear teeth ②

Wear/Damage → Replace both gears.

Excessive noises during operation → Replace both gears.

YB243014

**CLUTCH**

1. Inspect:

- Friction plate

Damage/Wear → Replace friction plate as a set.

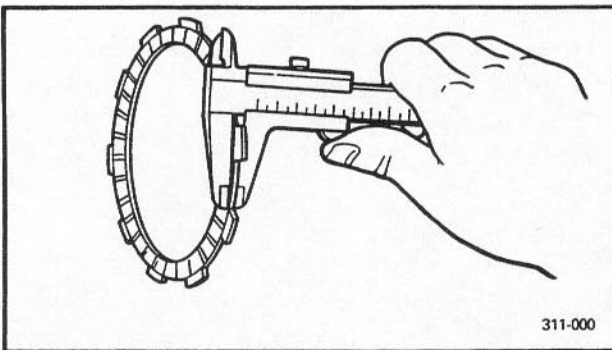

2. Measure:

- Friction plate thickness

Out of specification → Replace friction plate as a set.

Measure at all four points.

	Thickness	Wear limit
Type "A" (2 pcs.)	2.94 ~ 3.06 mm (0.116 ~ 0.120 in)	2.8 mm (0.110 in)
Type "B" (6 pcs.)	2.74 ~ 2.86 mm (0.108 ~ 0.113 in)	2.6 mm (0.102 in)



3. Inspect:

- Clutch plate

Damage→Replace clutch plate as a set.

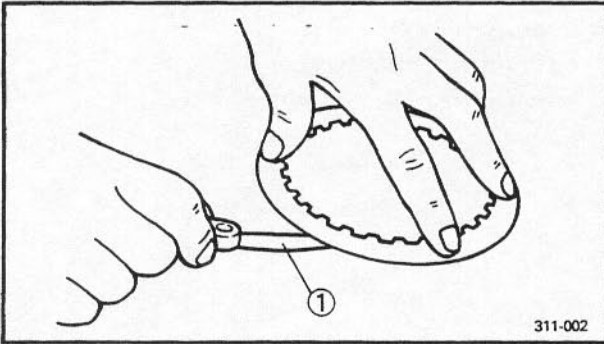

4. Measure:

- Clutch plate warpage

Out of specification→Replace clutch plate as a set.

Use a surface plate and feeler gauge ①.



**Warp limit:**

**Less than 0.2 mm (0.008 in)**

5. Inspect:

- Clutch spring

Damage→Replace as a set.

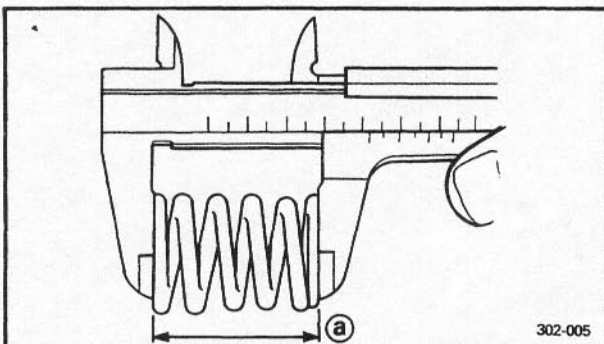

6. Measure:

- Clutch spring free length ②

Out of specification→Replace spring as a set.



**Free length (clutch spring):**

**42.8 mm (1.685 in)**

**< Limit: 40.8 mm (1.606 in) >**

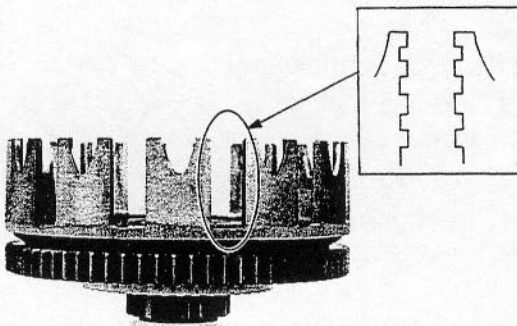

7. Inspect:

- Dogs on the clutch housing

Scoring/Wear/Damage→Deburr or replace.

**NOTE:**

Scoring on the clutch housing dogs will cause erratic operation.



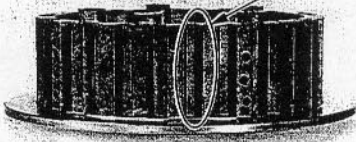
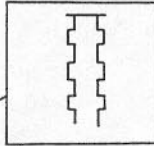

8. Inspect:

- Clutch boss splines

Scoring/Wear/Damage→Replace clutch boss.

**NOTE:** \_\_\_\_\_

Scoring on the clutch boss splines will cause erratic operation.

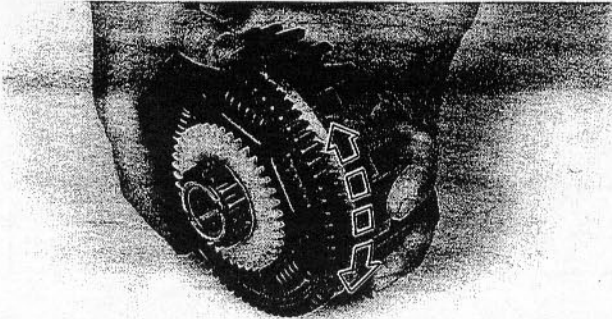

9. Check:

- Circumferential play

Free play exists→Replace.

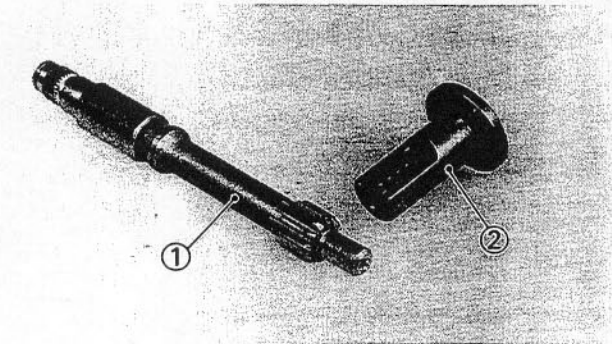

10. Inspect:

- Gear teeth (pull lever axle) ①

- Gear teeth (pull rod) ②

Wear/Damage→Replace as a set.

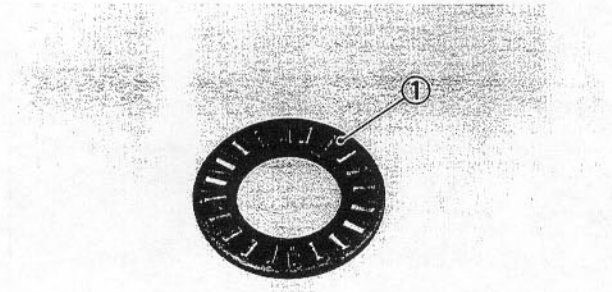

11. Inspect:

- Bearing ① (pull rod)

Wear/Damage→Replace.

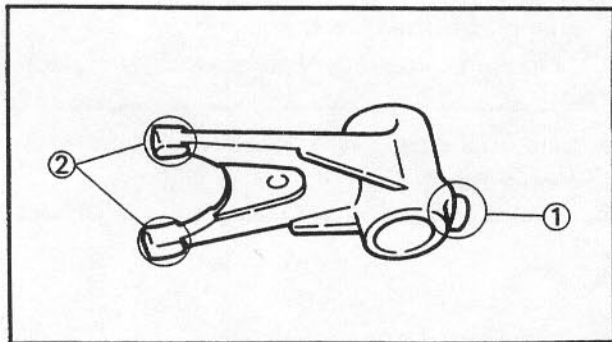

YB243015

## TRANSMISSION AND SHIFTER

1. Inspect:

- Shift fork cam follower ①

- Shift fork pawl ②

Scoring/Bends/Wear→Replace.

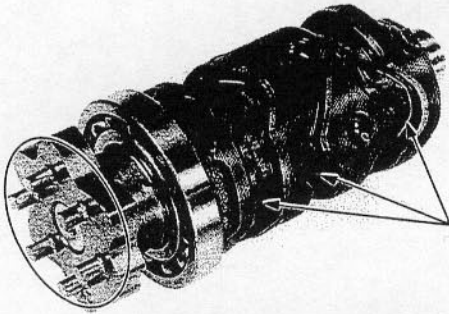

2. Inspect:
  - Shift cam groove
  - Shift cam segment
 Wear/Damage → Replace.

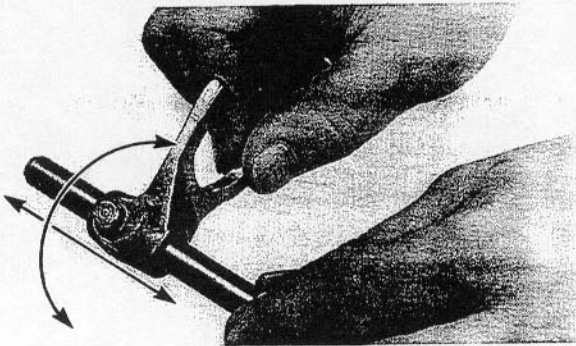

3. Check:
  - Shift fork movement
 Unsmooth operation → Replace shift fork and/or guide bar.

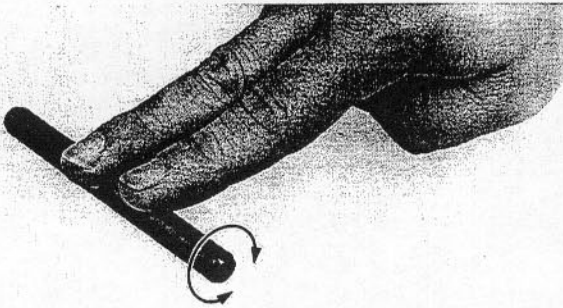

4. Inspect:
  - Guide bar
 Roll the guide bar on a flat surface.  
 Bends → Replace.

**⚠ WARNING**

Do not attempt to straighten a bent guide bar.

5. Measure:
  - Runout (drive axle and main axle)
 Out of specification → Replace.



**Runout:**  
 Less than 0.08 mm (0.003 in)

**⚠ WARNING**

Do not attempt to straighten a bent axle.

6. Inspect:
  - Gear teeth
  - Mated dogs
 Blue discoloration/Pitting/Wear → Replace.  
 Rounded edges/Cracks/Missing portions → Replace.

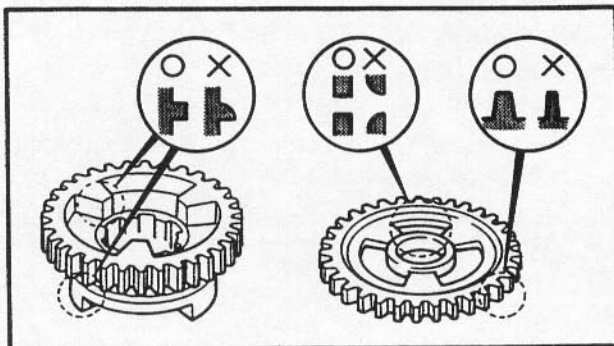
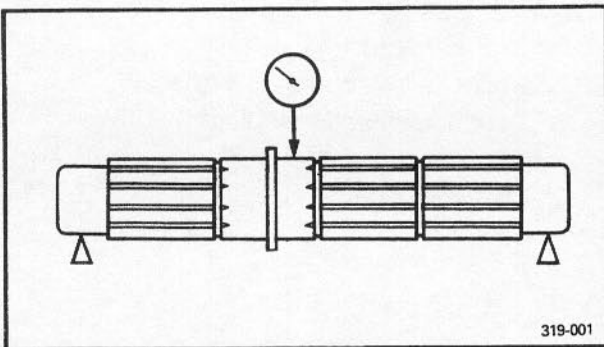

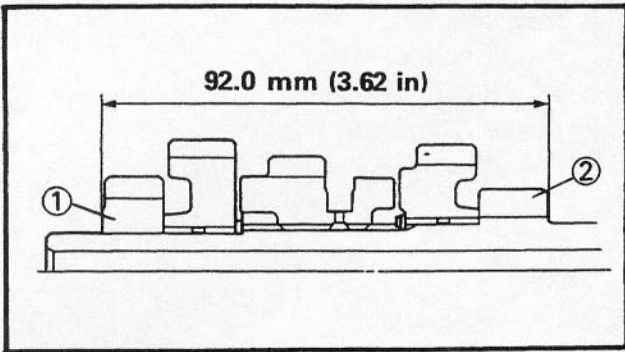

\*\*\*\*\*

**Reassembling point:**

- Press the 2nd pinion gear ① in the main axle ② as shown.

\*\*\*\*\*

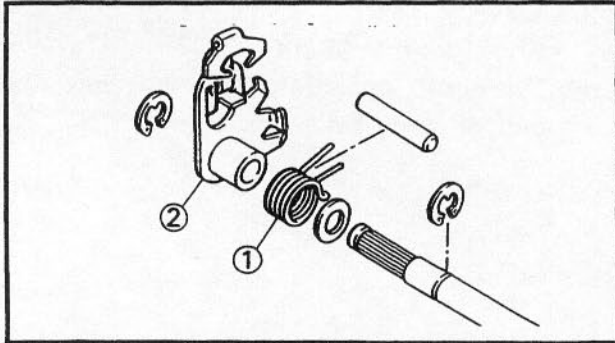

**7. Inspect:**

- Spring ①  
Damage → Replace.
- Shift lever ②  
Damage/Bends/Wear → Replace.

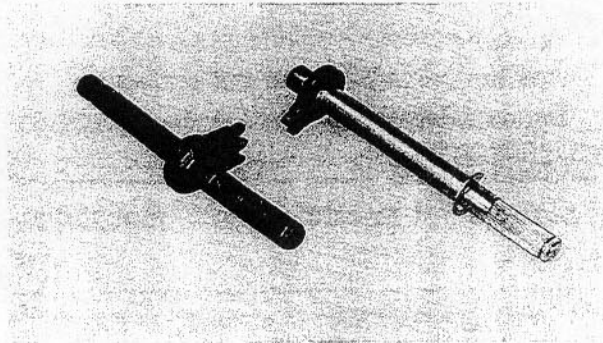

**8. Inspect:**

- Shift shaft  
Bends/Wear/Damage → Replace.

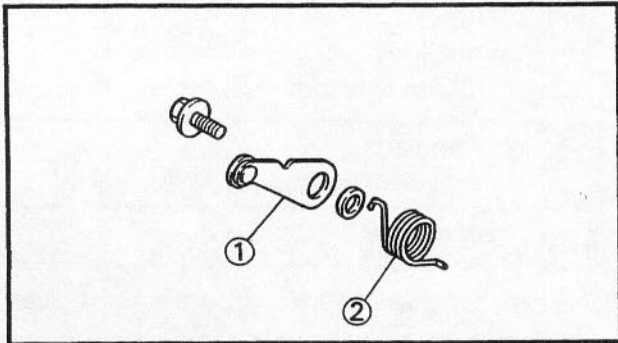

**9. Inspect:**

- Stopper lever ①  
Roller turns roughly → Replace.  
Bends/Damage → Replace.
- Return spring ②  
Damage/Cracks → Replace.

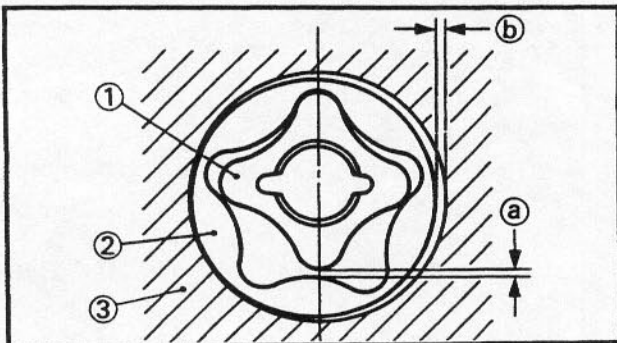

YB243016

**OIL PUMP, WATER PUMP AND STRAINER**

**1. Measure:**

- Tip clearance ①  
(between inner rotor ① and outer rotor ②)
  - Side clearance ②  
(between outer rotor ② and pump housing ③)
- Out of specifications → Replace oil pump.





Tip clearance:

0.12 mm (0.005 in)

Side clearance:

0.03 ~ 0.08 mm (0.001 ~ 0.003 in)

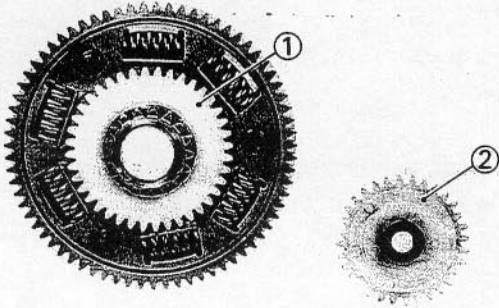

## 2. Inspect:

- Oil pump drive gear ①
  - Oil pump driven gear ②
- Wear/Cracks/Damage → Replace.

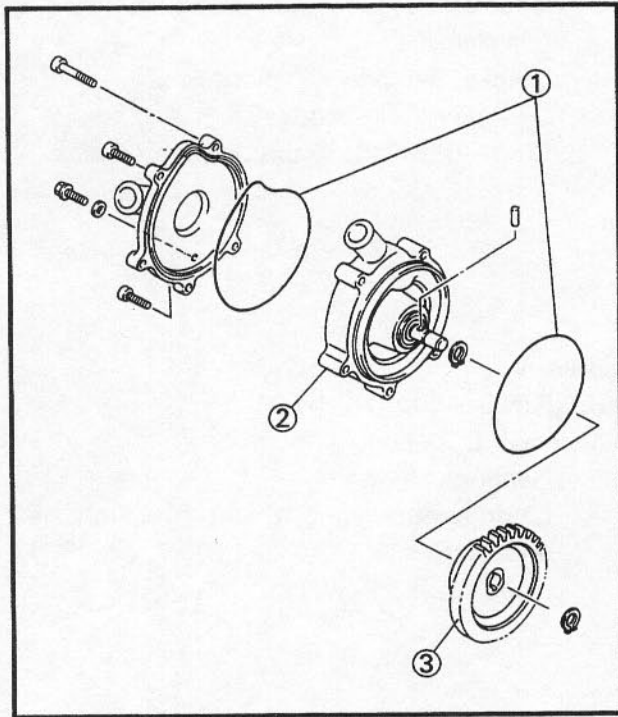

## 3. Inspect:

- O-ring ①
  - Water pump housing ②
  - Water pump gear ③
- Cracks/Wear/Damage → Replace.

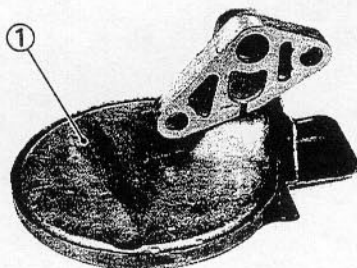

## 4. Inspect:

- Oil strainer ①
- Damage → Replace.



YB243017

**OIL DELIVERY PIPES**

1. Inspect
  - Oil delivery pipes
  - Cracks/Damages → Replace.
  - Clog → Blow out with compressed air.

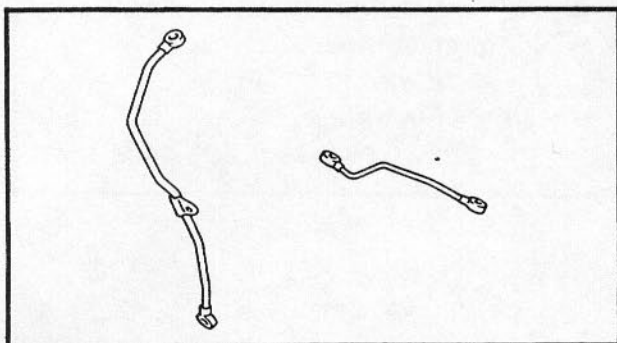

YB243018

**CRANKCASE**

1. Thoroughly wash the case halves in mild solvent.
2. Clean all the gasket mating surface and crankcase mating surface thoroughly.
3. Inspect:
  - Crankcase
  - Cracks/Damage → Replace.
  - Oil delivery passages
  - Clog → Blow out with compressed air.

YB243019

**BEARING AND OIL SEAL**

1. Inspect:
  - Bearings
  - Clean and lubricate, then rotate inner race with finger.
  - Roughness → Replace.
2. Inspect:
  - Oil seals
  - Damage/Wear → Replace.



YB243020

**CIRCLIP AND WASHER**

**1. Inspect:**

- Circlips
- Washers

Damage/Looseness/Bends → Replace.





## ENGINE ASSEMBLY AND ADJUSTMENT

### VALVE AND ROCKER ARM

- |                             |                              |
|-----------------------------|------------------------------|
| ① Rocker arm #2             | ⑨ Valve (intake)             |
| ② Wave washer               | ⑩ Spring seat                |
| ③ Rocker arm shaft (intake) | ⑪ Rocker arm shaft (exhaust) |
| ④ Rocker arm #1             | ⑫ Rocker arm #4              |
| ⑤ Valve cotter              | ⑬ Rocker arm #3              |
| ⑥ Valve retainer            | ⑭ Rocker arm shaft (exhaust) |
| ⑦ Oil seal                  | ⑮ Valve (exhaust)            |
| ⑧ Valve spring              |                              |

**B VALVE SPRING TILT LIMIT:**  
 Inner spring:  
 2.5° or 1.4 mm (0.055 in)  
 Outer spring:  
 2.5° or 1.6 mm (0.063 in)

**A VALVE CLEARANCE (COLD):**  
 Intake: 0.10~0.15 mm (0.004~0.006 in)  
 Exhaust: 0.15~0.20 mm (0.006~0.008 in)

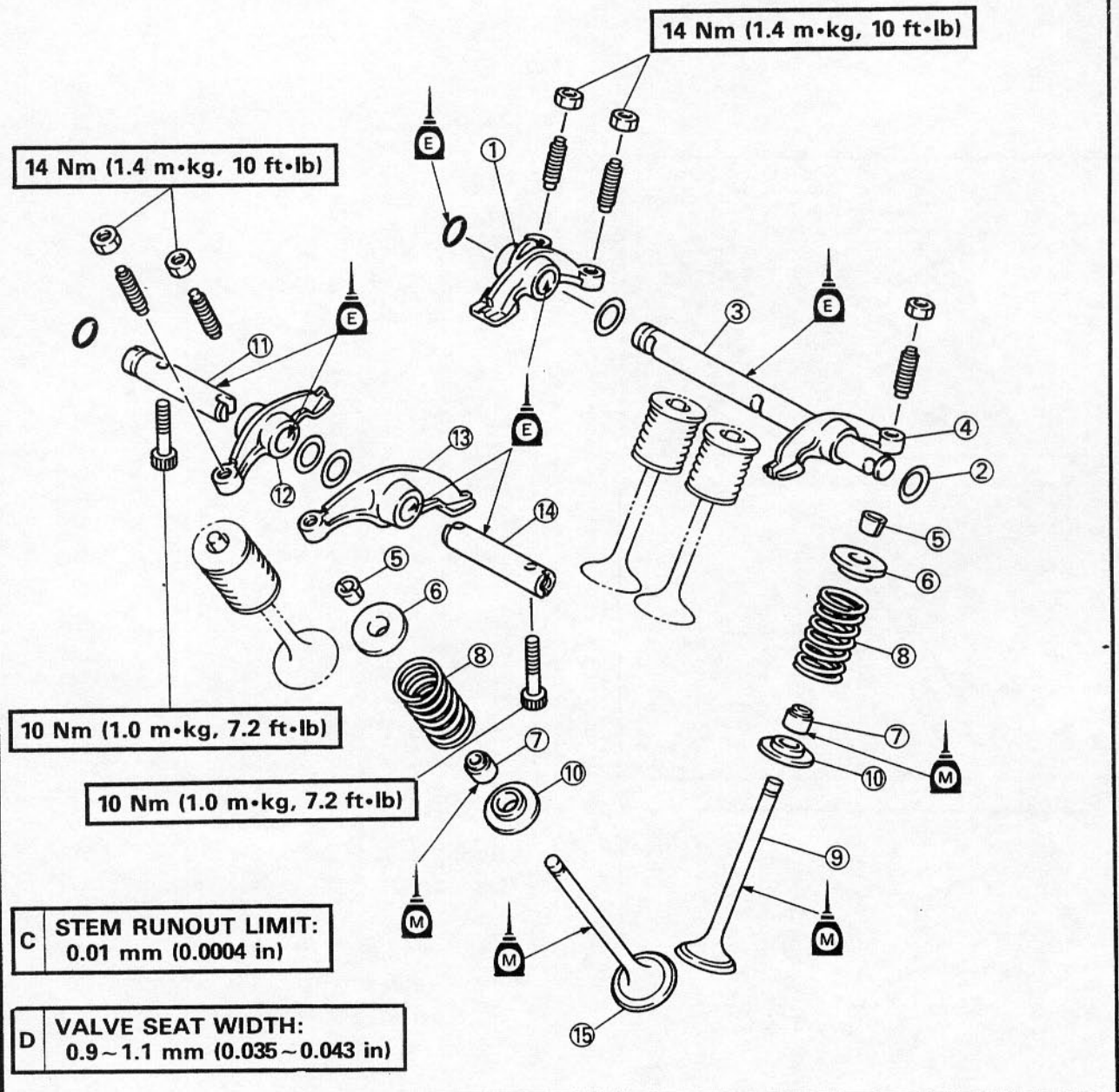



YB244000

## ENGINE ASSEMBLY AND ADJUSTMENT

### ⚠ WARNING

For engine reassembly, replace the following parts with new ones.

- O-ring
- Gasket
- Oil seal
- Copper washer
- Lock washer
- Circlip

YB344002

### VALVES

#### 1. Deburr:

- Valve stem end

Use an oil stone to smooth the stem end.

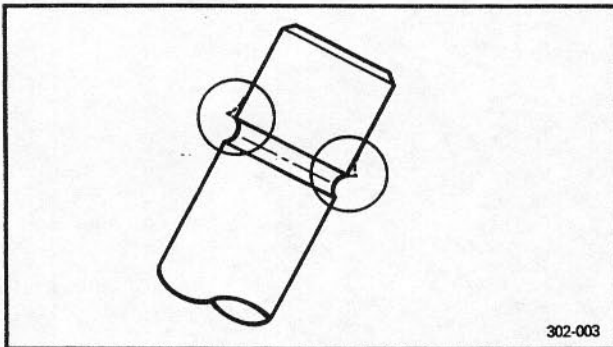

#### 2. Apply:

- Molybdenum disulfide oil  
(onto valve stem and oil seal)

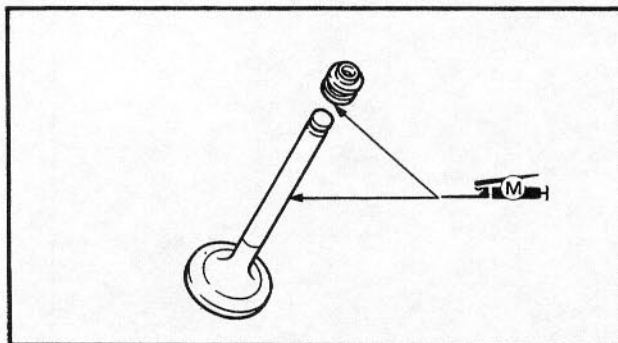

#### 3. Install:

- Spring seat ①
- Oil seal ②
- Valve ③
- Valve spring ④
- Valve retainer ⑤  
(into cylinder head)

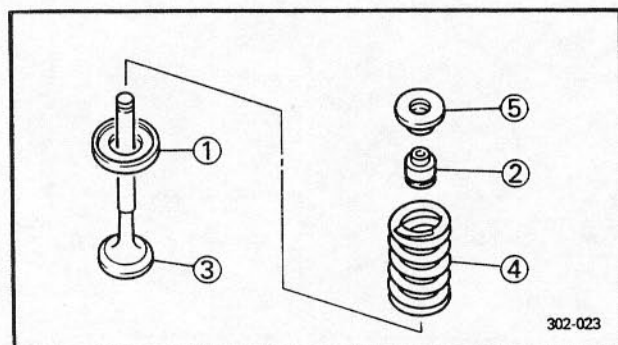

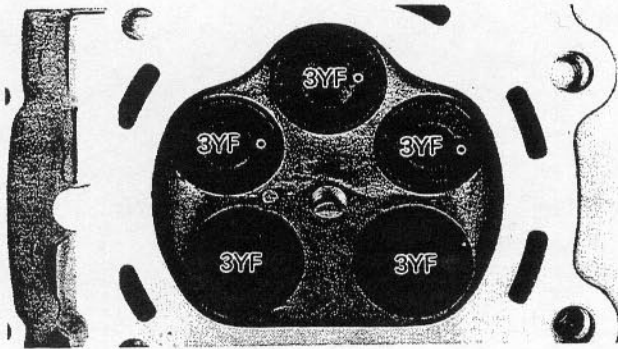

**NOTE:** \_\_\_\_\_

- Make sure that each valve is installed in its original place by reference to its embossed identification mark, as follows:

Intake: 3YF•

Exhaust: 3YF

- Install the valve spring with larger pitch ⑥ facing upward.

⑦ Smaller pitch

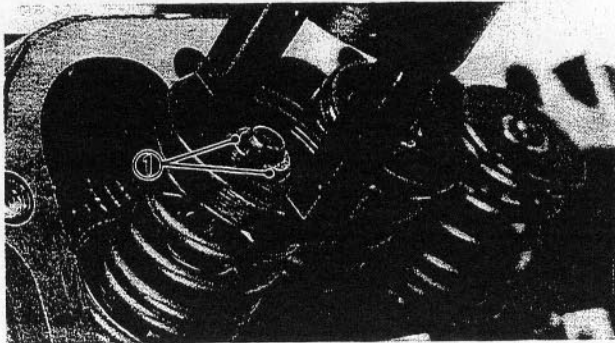
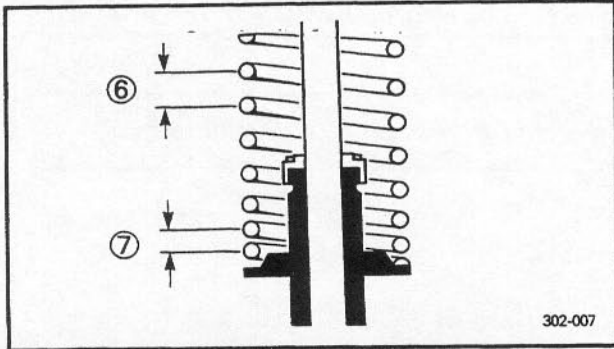

4. Install:

- Valve cotters ①

**NOTE:** \_\_\_\_\_

Install the valve cotters while compressing the valve spring with the valve spring compressor.



**Valve spring compressor:**

P/N. YM-04019, 90890-04019

5. Secure the valve cottoer on to the valve stem by tapping it lightly with a piece of wood.

**NOTE:** \_\_\_\_\_

Do not hit so much as to damage the valve.



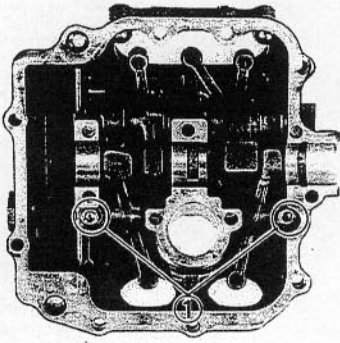

### ROCKER ARM

1. Lubricate:
  - Engine oil  
(to the rocker arm shaft)
  
2. Install:
  - Rocker arm
  - Rocker arm shaft



**Bolt ① (rocker arm shaft):**  
**10 Nm (1.0 m•kg, 7.2 ft•lb)**

### NOTE:

Numeral is stamped on the rocker arm.

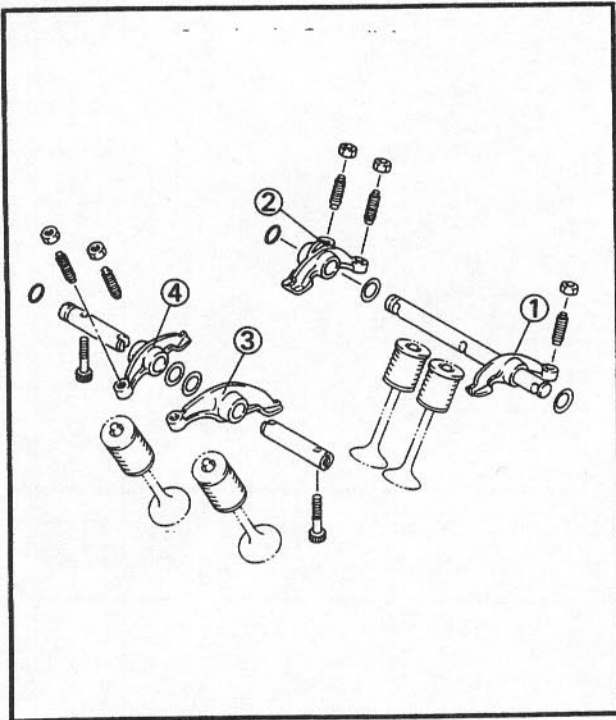

- ① #1
- ② #2
- ③ #3
- ④ #4

3. Install:
  - Plug ①

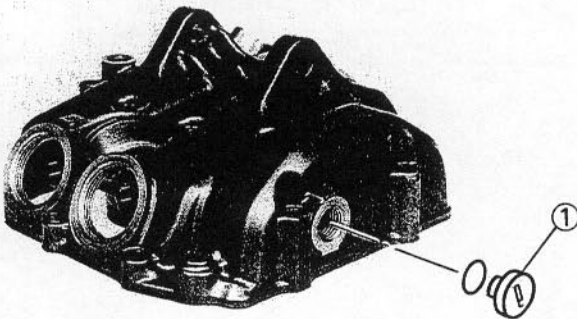



### CRANKSHAFT

- ① Crank pin
- ② Crank (left)
- ③ Connecting rod
- ④ Bearing
- ⑤ Bearing

A	<b>CRANK WIDTH:</b> 74.95 ~ 75.00 mm (2.950 ~ 2.953 in)
B	<b>RUNOUT LIMIT:</b> 0.03 mm (0.0012 in)
C	<b>SMALL END FREE PLAY:</b> 0.8 mm (0.031 in)
D	<b>BIG END RADIAL CLEARANCE:</b> 0.01 ~ 0.025 mm (0.0004 ~ 0.0010 in)
E	<b>BIG END SIDE CLEARANCE:</b> 0.35 ~ 0.65 mm (0.013 ~ 0.026 in)

B6307SH2-C4

N37-45-22

B6307SH2-C4

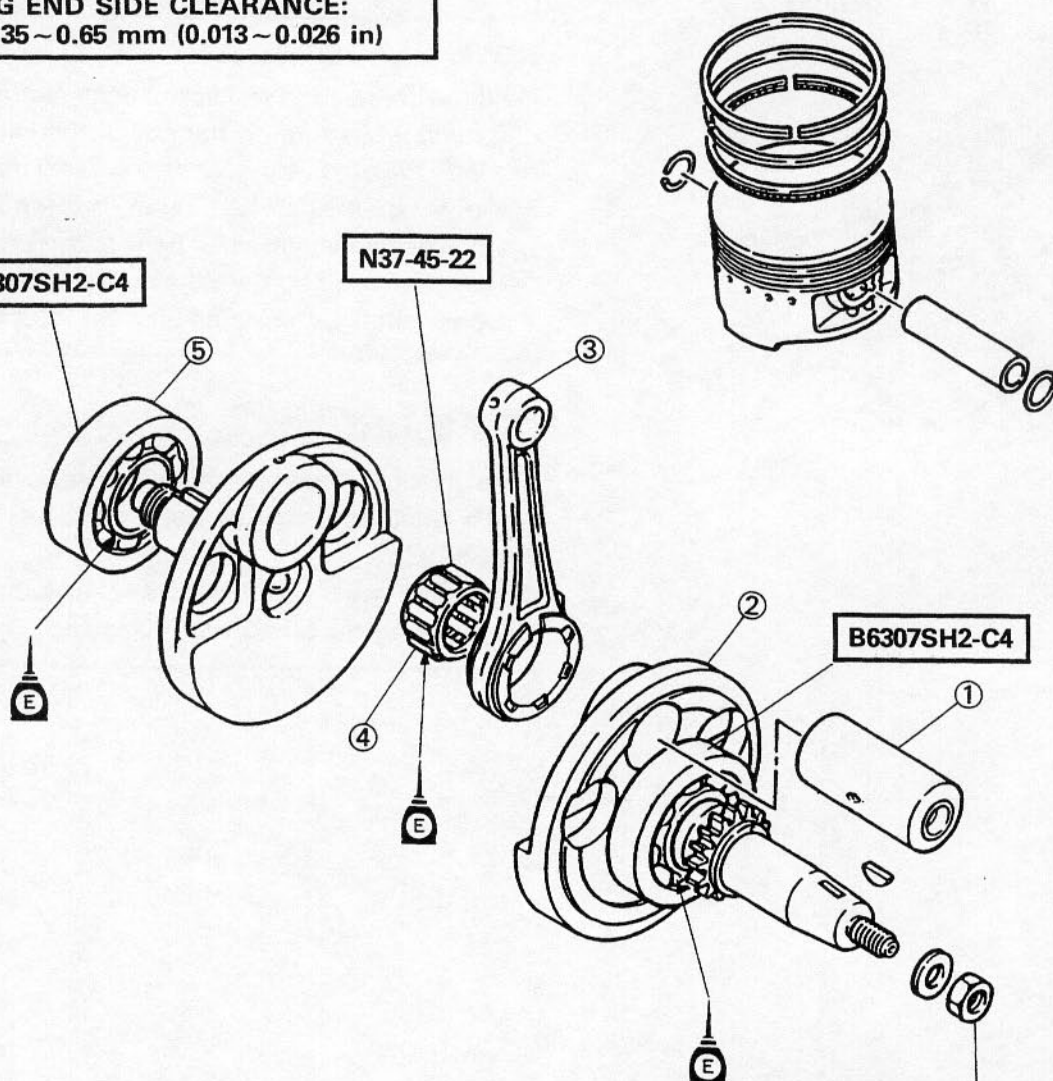

150 Nm (15.0 m·kg, 110 ft·lb)

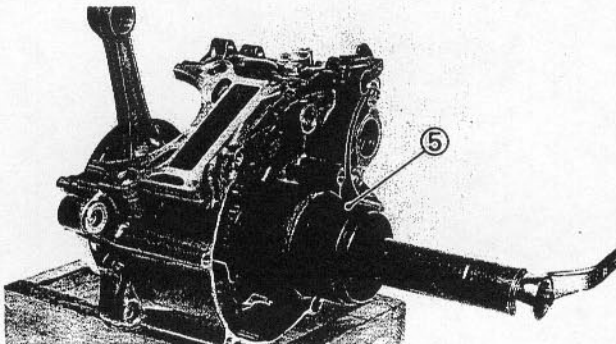
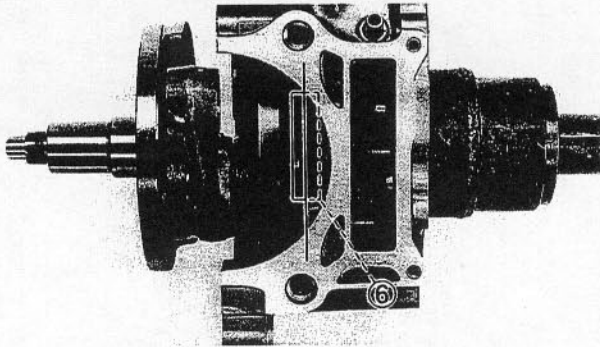
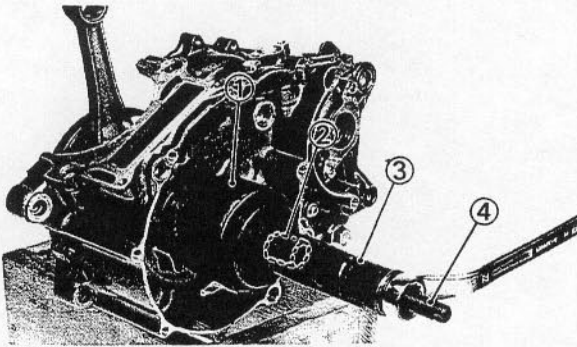
**CRANKSHAFT**

## 1. Attach:

- Crankshaft installing tool



**Crankshaft installer set:**

P/N. YU-90050

**Crank pot spacer ①:**

P/N. YM-91044

P/N. 90890-04081

**Adapter # 10 ②:**

P/N. YM-90069

P/N. 90890-04059

**Crankshaft installer pot ③:**

P/N. 90890-01274

**Crankshaft installer bolt ④:**

P/N. 90890-01275

**Spacer ⑤:**

P/N. 90890-01288

**NOTE:**

Hold the connecting rod at top dead center with one hand while turning the nut of the installing tool with the other. Operate the installing tool until half of the crankshaft bearing ⑥ is inserted into the crankcase as shown. Then, add the spacer ⑤ as shown and operate the installing tool until the crankshaft bottoms against the bearing.

**CAUTION:**

To protect the crankshaft against scratches or to facilitate the operation of the installation.

Apply the grease to the oil seal lips, and apply the engine oil to each bearing.





## BALANCER AND TRANSMISSION

- |                  |                   |            |
|------------------|-------------------|------------|
| ① Drive sprocket | ⑩ Bearing         | ⑲ Balancer |
| ② Oil seal       | ⑪ Bearing         | ⑳ Bearing  |
| ③ Bearing        | ⑫ 2nd pinion gear |            |
| ④ 2nd wheel gear | ⑬ 5th pinion gear |            |
| ⑤ Drive axle     | ⑭ 3rd pinion gear |            |
| ⑥ 5th wheel gear | ⑮ 4th pinion gear |            |
| ⑦ 3rd wheel gear | ⑯ Main axle       |            |
| ⑧ 4th wheel gear | ⑰ Bearing         |            |
| ⑨ 1st wheel gear | ⑱ Bearing         |            |

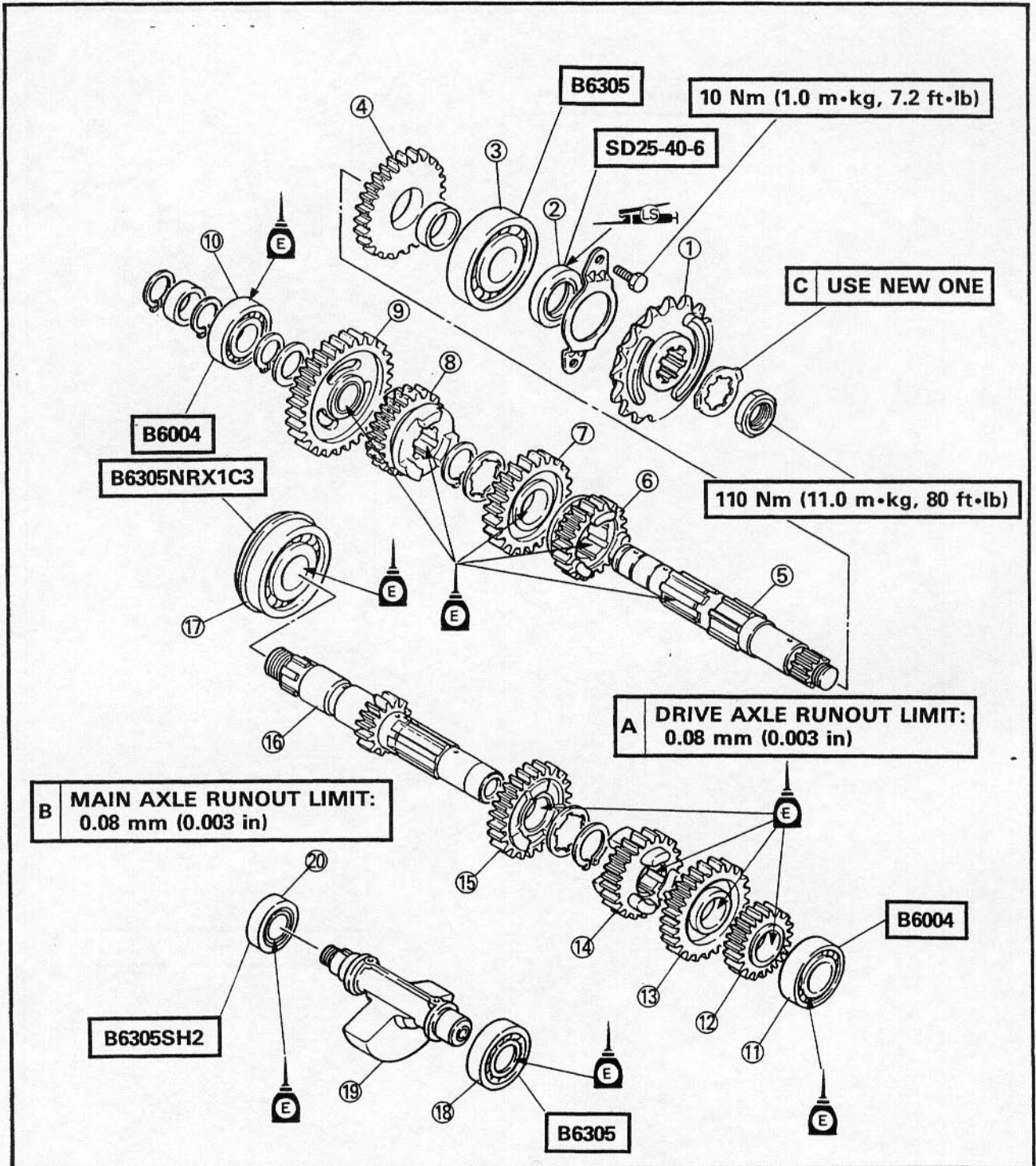



### SHIFTER

- ① Guide bar (long)
- ② Shift fork #3 "R"
- ③ Shift fork #1 "L"
- ④ Shift cam
- ⑤ Guide bar (short)
- ⑥ Shift fork #2 "C"
- ⑦ Shift shaft 2
- ⑧ Shift shaft
- ⑨ Oil seal

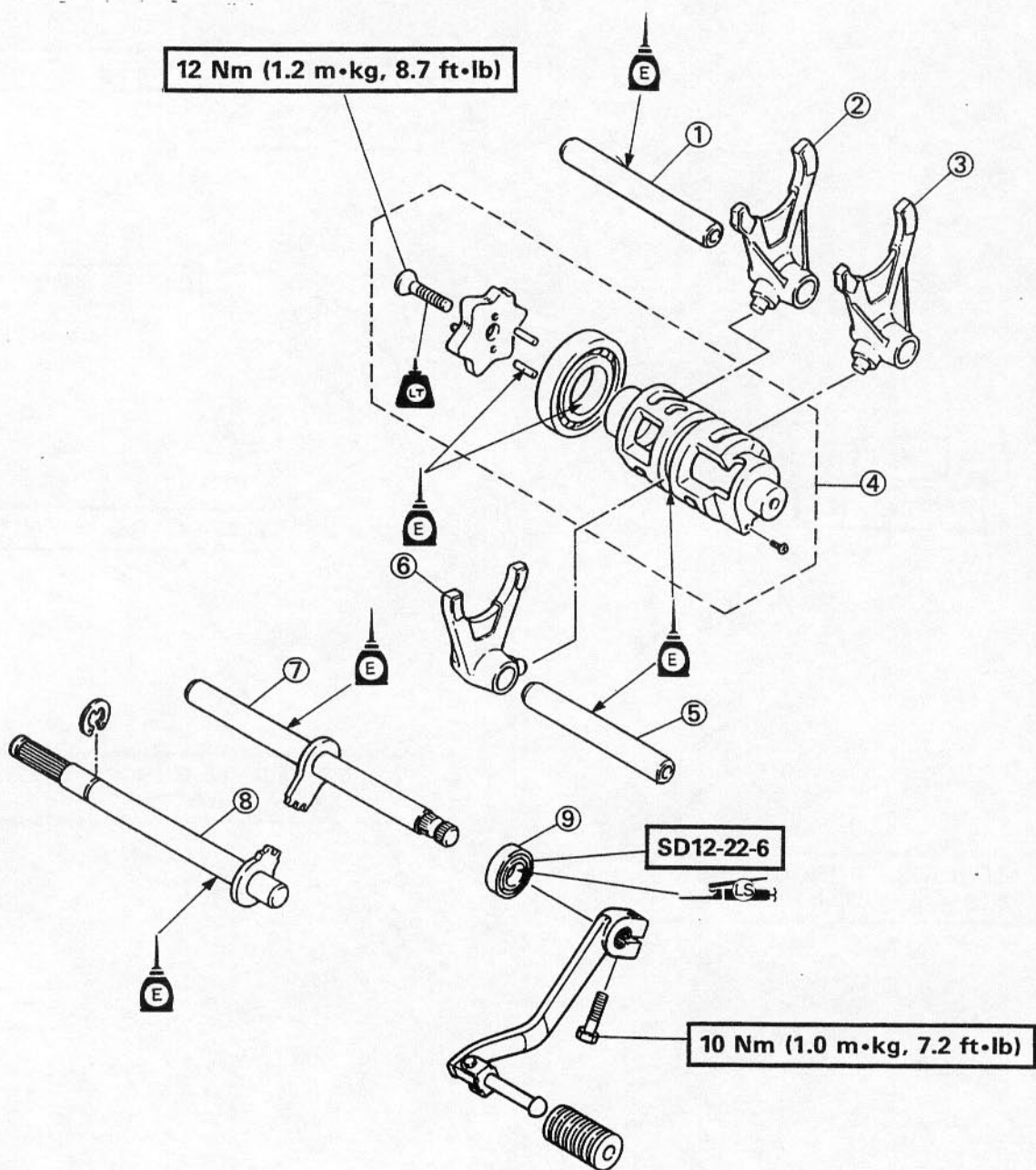



YB244004

## BALANCER, TRANSMISSION AND SHIFTER

### 1. Install:

- Neutral switch ①

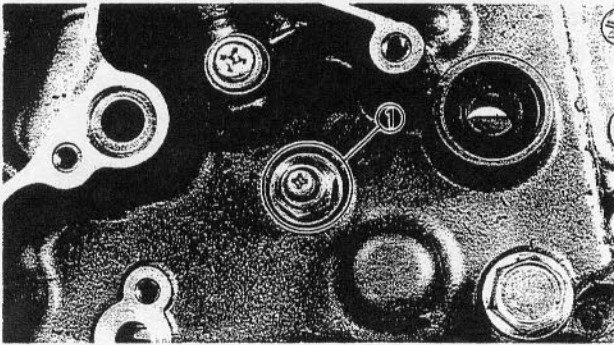

### 2. Install:

- Balancer shaft ①

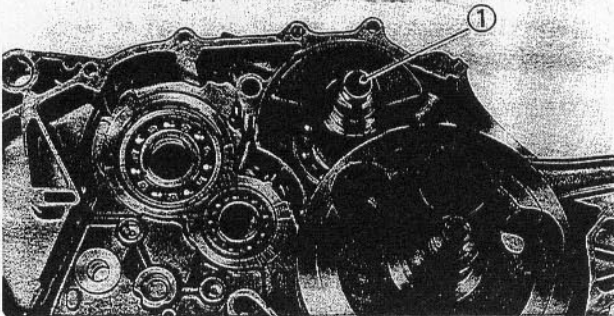

### 3. Install:

- Collar ①
- Drive axle assembly ②

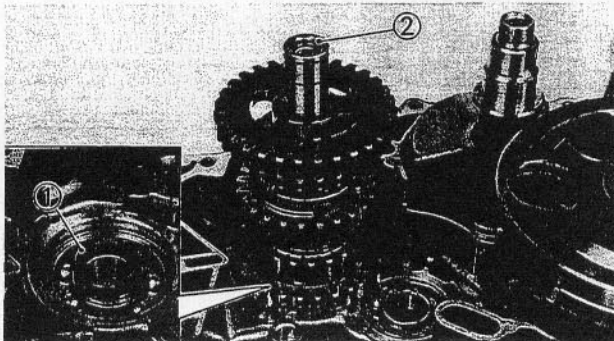

### 4. Install:

- Main axle assembly ①

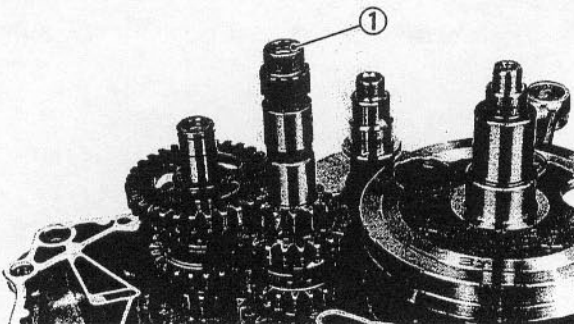

### 5. Apply:

- Engine oil  
(onto guide bars)



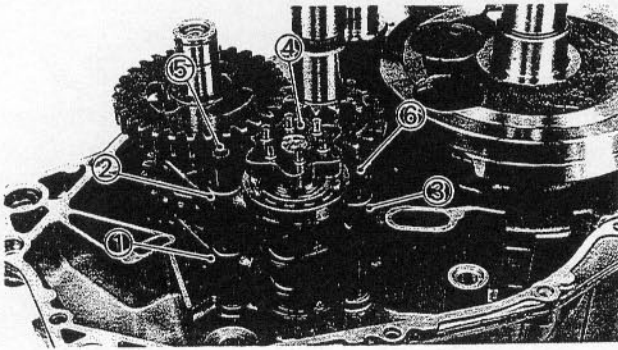

### 6. Install:

- Shift fork 1 "L" ①
- Shift fork 3 "R" ②
- Shift fork 2 "C" ③
- Shift cam ④
- Guide bar (long) ⑤
- Guide bar (short) ⑥

### NOTE:

Install the shift forks with the embossed mark on each shift fork facing right side of the engine.

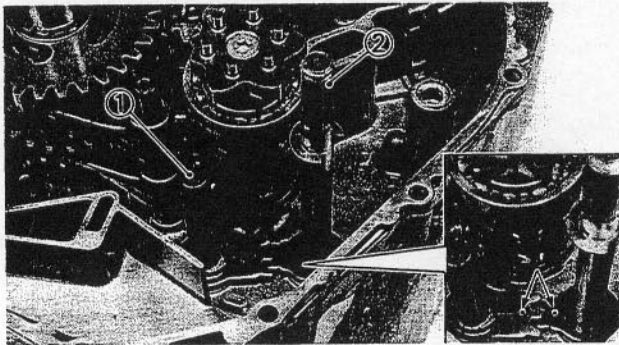

### 7. Install:

- Shift shaft 2 ①
- Shift shaft ②

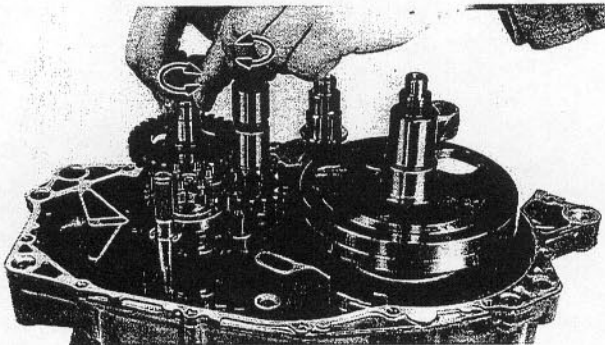

### 8. Check:

- Transmission operation unsmooth operation  
→ Repair.



OIL STRAINER

- ① Oil strainer
- ② Oil passage cover
- ③ Gasket

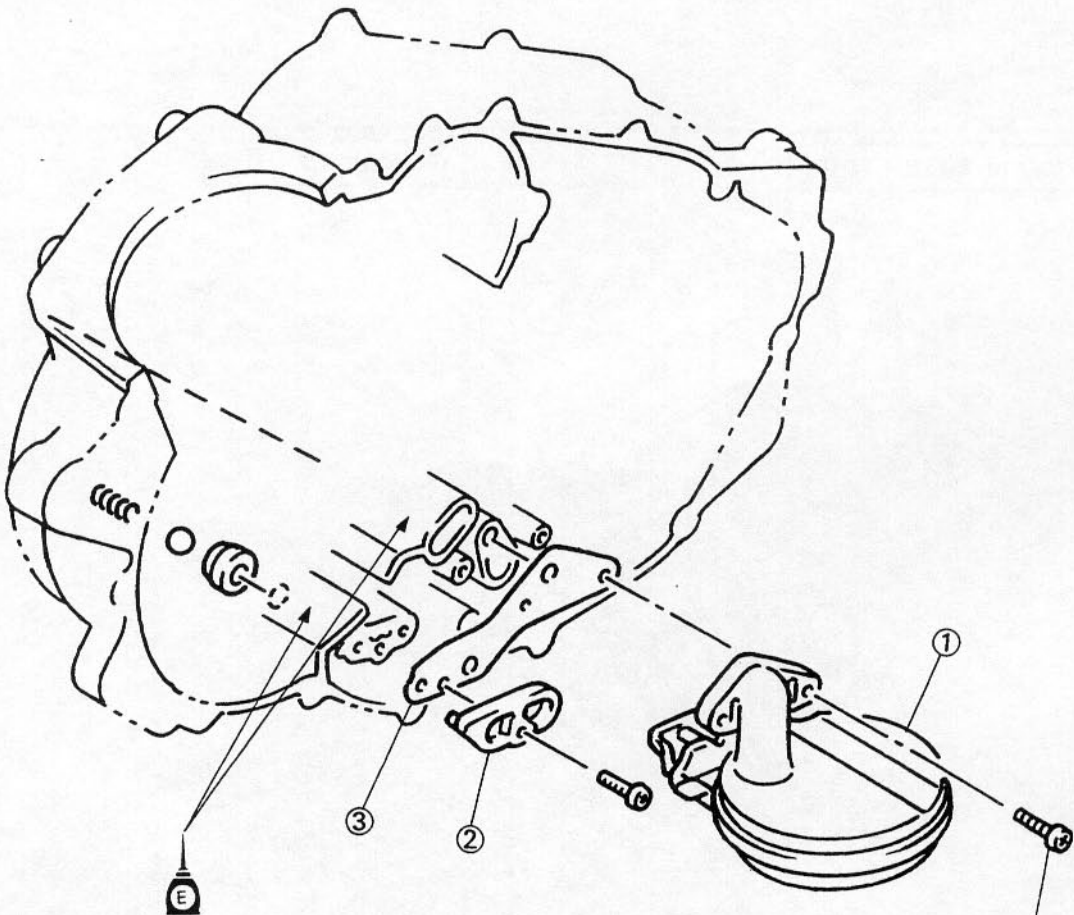

7 Nm (0.7 m•kg, 5.1 ft•lb)



### CRANKCASE

- ① Bearing cover plate
- ② Lock plate
- ③ Crankcase ventilation hose
- ④ Cable clamp
- ⑤ Crankcase
- ⑥ Collar
- ⑦ Dowel pin
- ⑧ Dowel pin
- ⑨ O-ring

#### A TIGHTENING SEQUENCE:

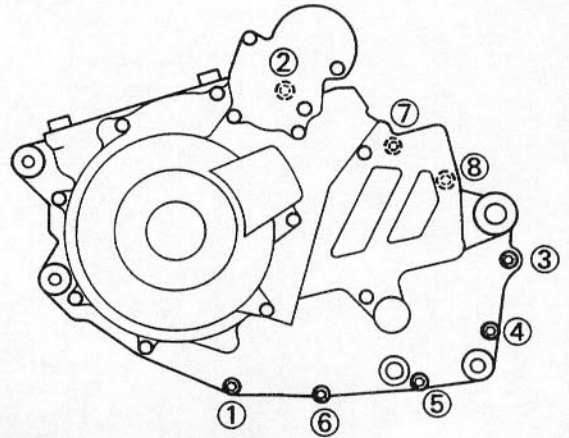
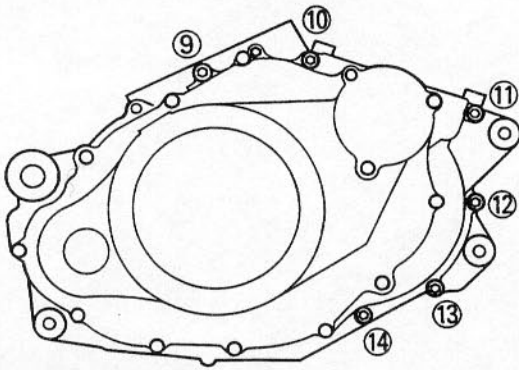

7 Nm (0.7 m·kg, 5.1 ft·lb)

10 Nm (1.0 m·kg, 7.2 ft·lb)

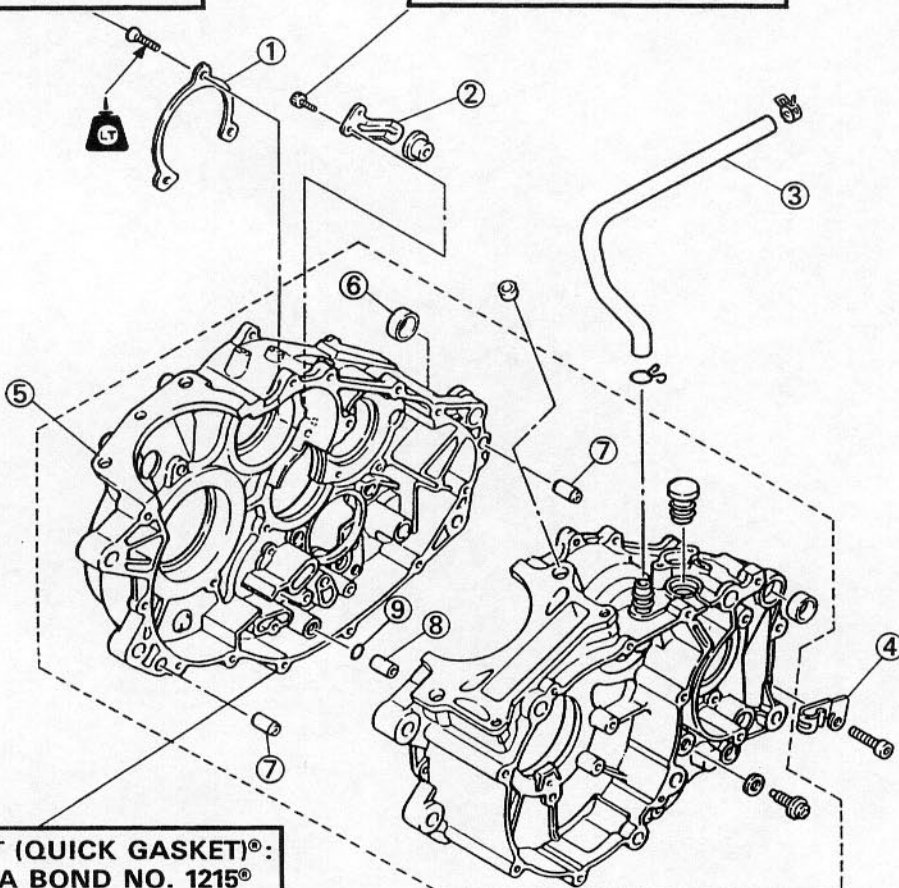

**B SEALANT (QUICK GASKET)<sup>®</sup>:  
YAMAHA BOND NO. 1215<sup>®</sup>**





## SHIFT LEVER AND OIL PUMP

- |                 |                  |
|-----------------|------------------|
| ① Stopper lever | ⑥ Torsion spring |
| ② Collar        | ⑦ Gasket         |
| ③ Return spring | ⑧ O-ring         |
| ④ Collar        | ⑨ Oil pump       |
| ⑤ Shift lever   | ⑩ Oil pump gear  |

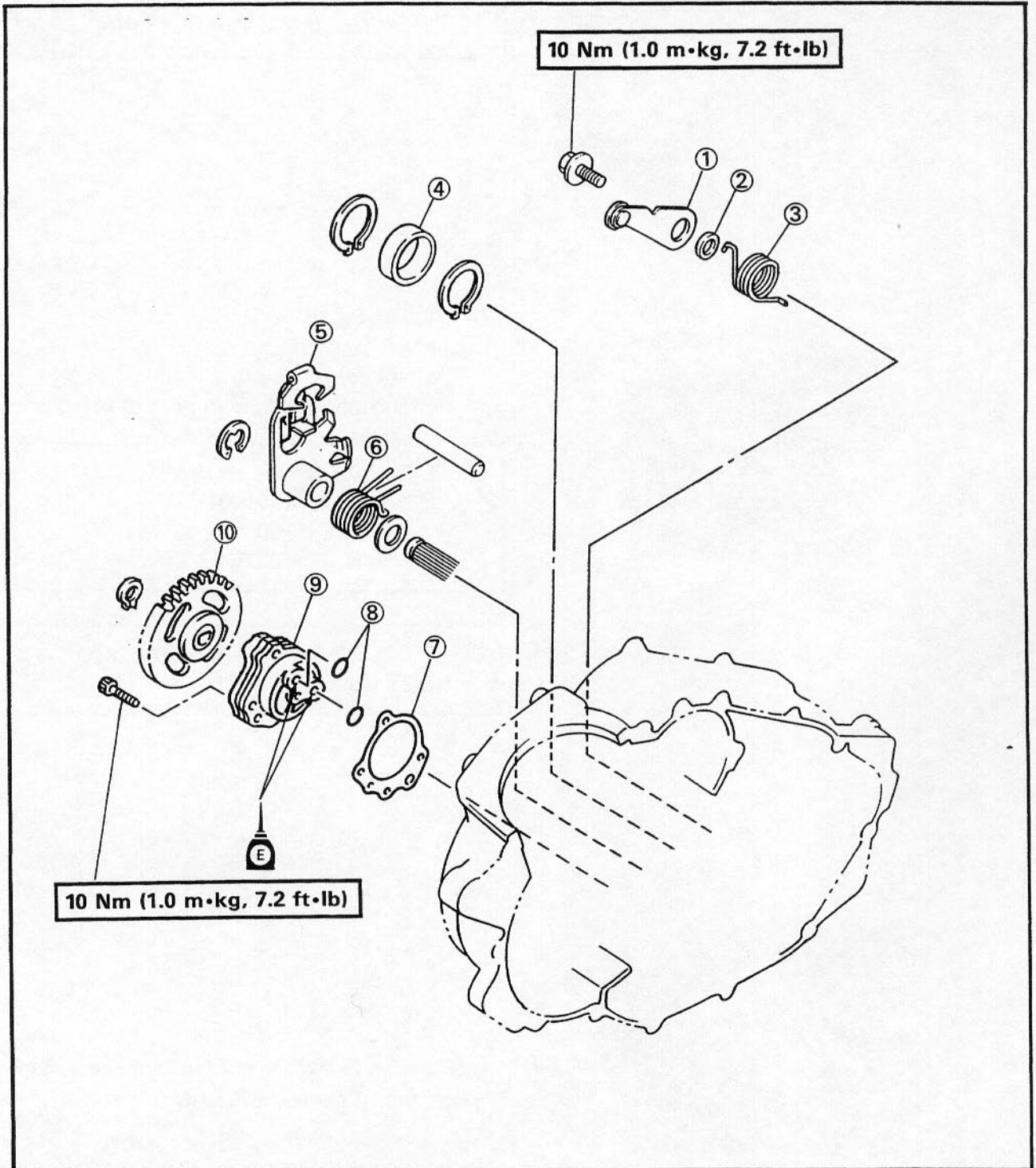

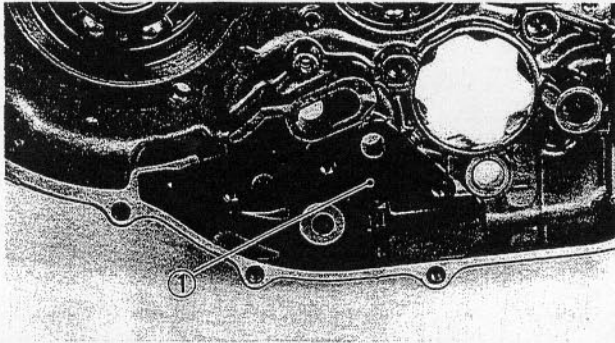

### OIL STRAINER

1. Install:

- Gasket ①
- Oil strainer ②
- Oil passage cover ③



**Bolt (oil strainer):**

7 Nm (0.7 m•kg, 5.1 ft•lb)

**Bolt (oil passage cover):**

7 Nm (0.7 m•kg, 5.1 ft•lb)

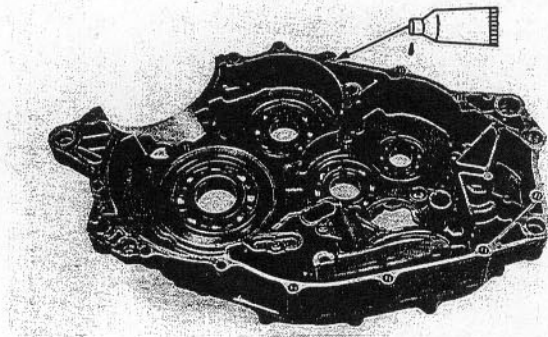
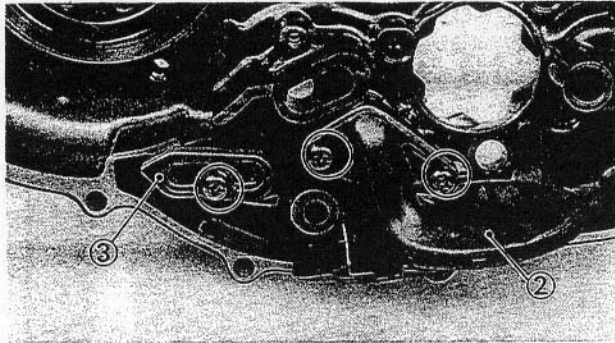

### CRANKCASE (RIGHT)

1. Apply:

- Sealant

(onto mating surfaces of both case halves)



**Sealant (quick gasket)<sup>®</sup>:**

P/N. ACC-11001-01

**Yamaha Bond No. 1215<sup>®</sup>:**

P/N. 90890-85505

### NOTE:

DO NOT ALLOW any sealant to come in contact with the oil gallery.

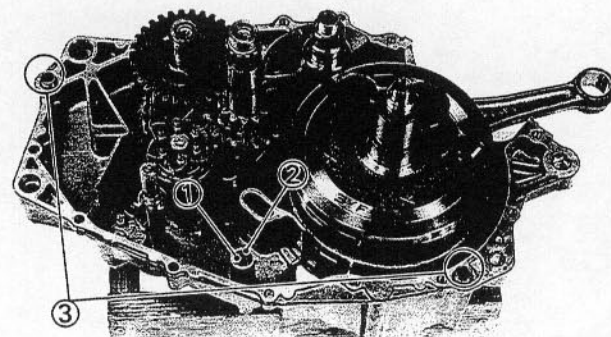

2. Install:

- O-ring ①
- Dowel pin ②
- Dowel pins ③

3. Fit the left crankcase onto the right case. Tap lightly on the case with a soft hammer.

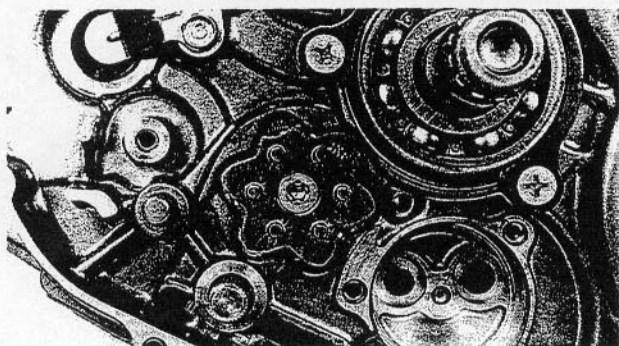

**NOTE:**  
Turn the shift cam to the position shown in the figure so that it does not contact the crankcase when installing the crankcase.

**CAUTION:**  
Before installing and torquing the crankcase holding screws, be sure to check whether the transmission is functioning properly by manually rotating the shift cam either way.

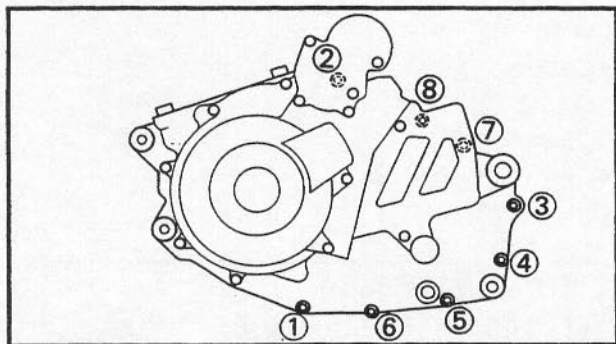

4. Tighten:  
• Bolt (crankcase) ①~⑭

**NOTE:**  
• Tighten the bolts starting with the lowest numbered one.  
• Install the cable clamp on the bolt No. 4.

**Bolts (crankcase):**  
10 Nm (1.0 m•kg, 7.2 ft•lb)

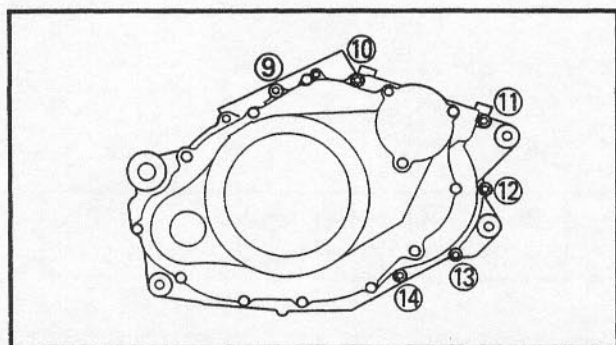

5. Apply:  
• 4-stroke engine oil  
(to the crank pin, bearing and oil delivery hole)

6. Check:  
• Crankshaft and transmission operation  
Unsmooth operation → Repair.

## SHIFT LEVER AND OIL PUMP

1. Install:  
• Circlip ① (to drive axle)  
• Collar ②  
• Circlip ③

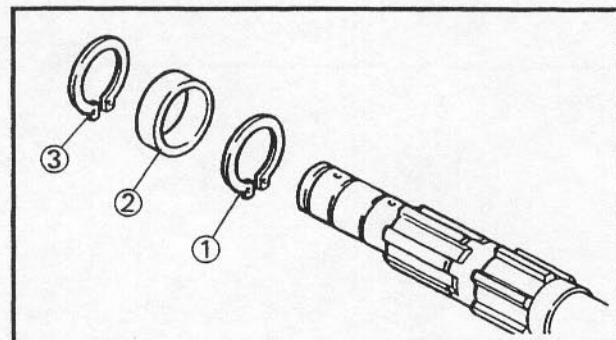



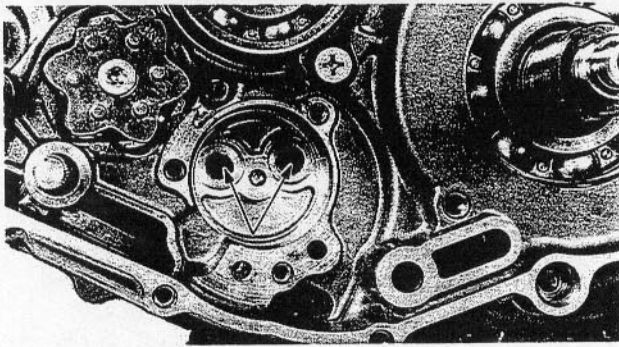

2. Apply:
  - 4-stroke engine oil  
(to the oil passages in the crankcase)

**CAUTION:** \_\_\_\_\_

Apply a liberal amount of 4-stroke engine oil to the oil pump passages in the crankcase, or the engine may be damaged.

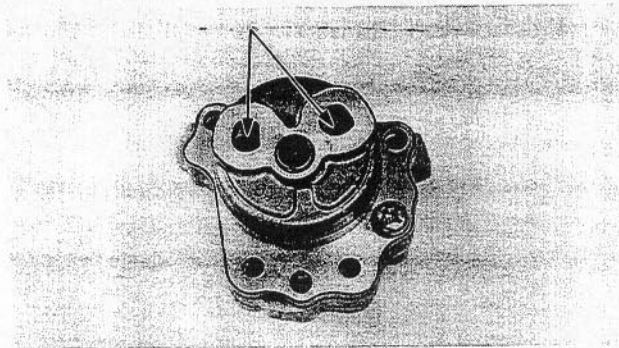

3. Apply:
  - 4-stroke engine oil  
(to the oil passages in the oil pump)

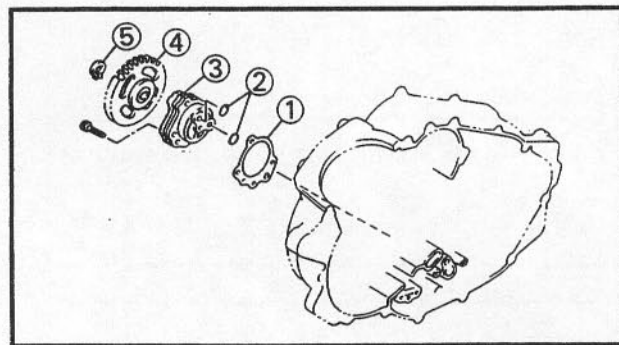

4. Install:
  - Gasket ①
  - O-ring ②
  - Oil pump ③
  - Oil pump gear ④
  - Circlip ⑤

 **Bolt (oil pump):**  
10 Nm (1.0 m•kg, 7.2 ft•lb)

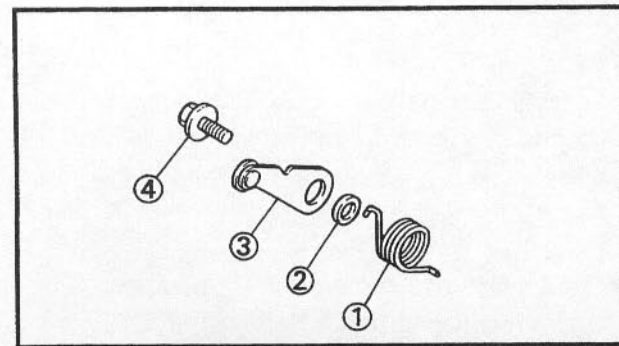

5. Install:
  - Return spring ①
  - Collar ②
  - Stopper lever ③

 **Bolt ④ (stopper lever):**  
10 Nm (1.0 m•kg, 7.2 ft•lb)

**NOTE:** \_\_\_\_\_  
Set the spring and stopper lever at proper position.

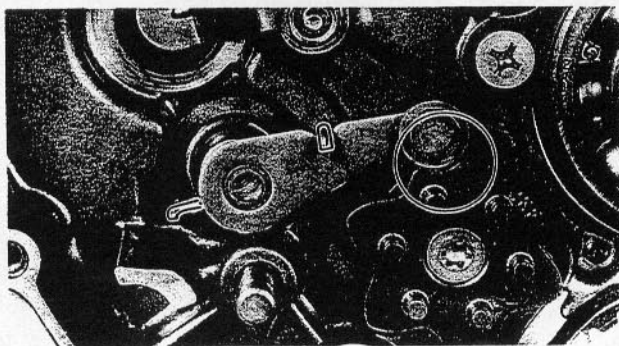

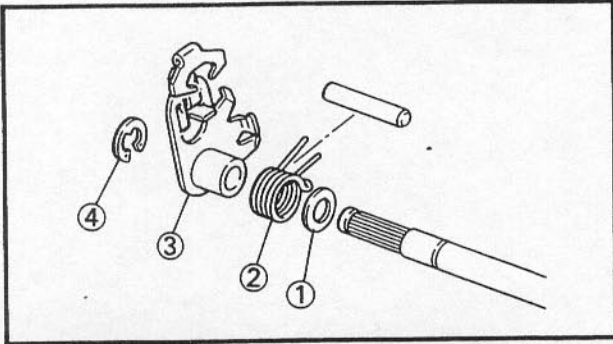

6. Install:

- Plain washer ①
- Torsion spring ②
- Shift lever ③
- Circlip ④

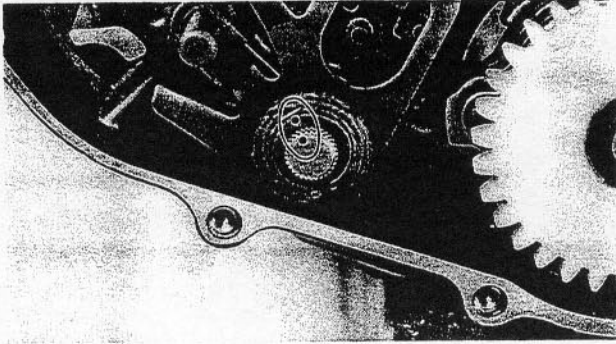

**NOTE:** \_\_\_\_\_

When installing the shift lever, align the punched mark on the shift lever with the punched mark on the shift shaft.

\_\_\_\_\_



## BALANCER GEAR

- ① Key
- ② Balancer gear
- ③ Plate
- ④ Lock washer
- ⑤ Nut
- ⑥ Plate washer
- ⑦ Key
- ⑧ Plate
- ⑨ Balancer drive gear
- ⑩ Plate
- ⑪ Primary drive gear
- ⑫ Lock washer
- ⑬ Nut

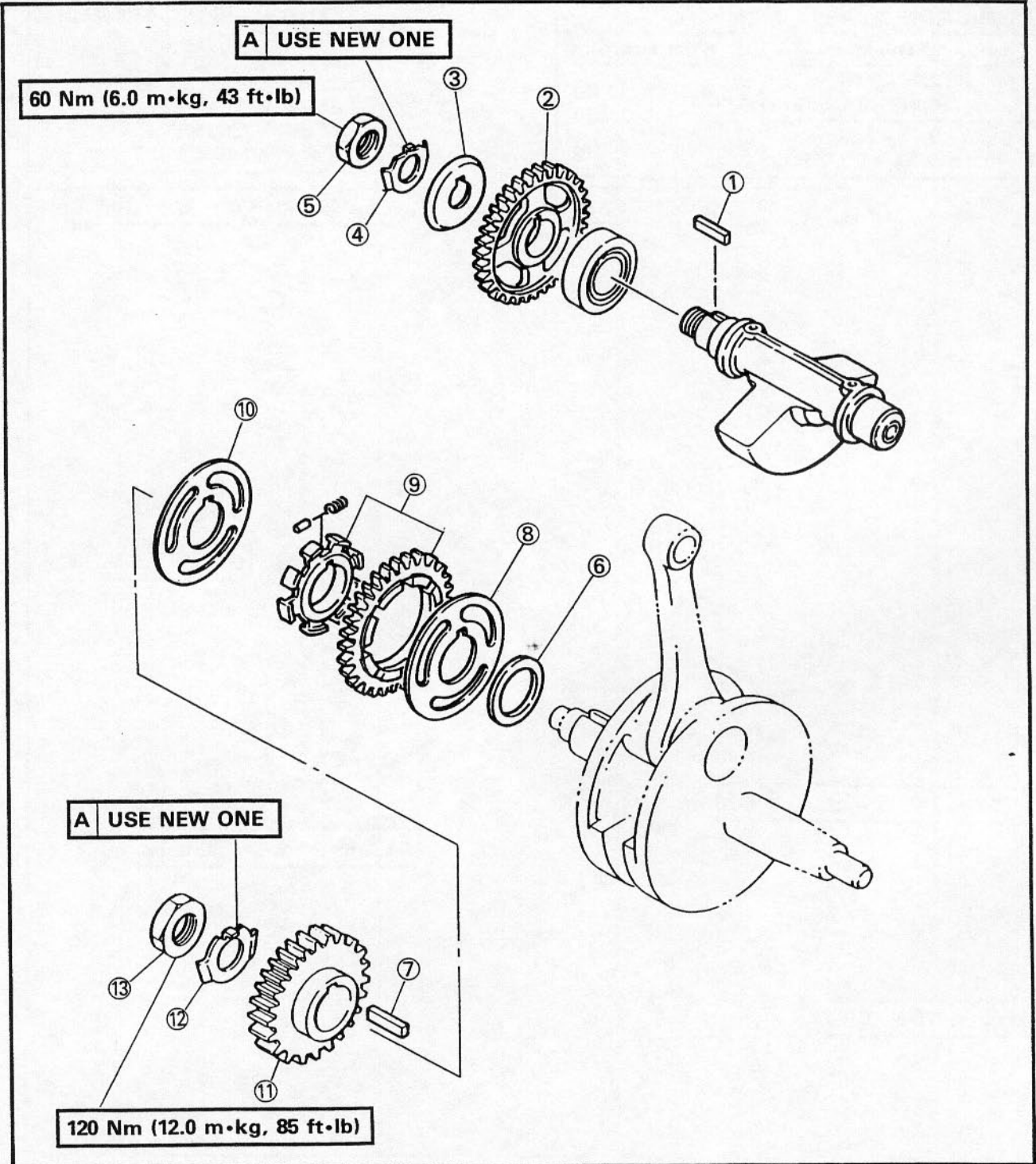





### CLUTCH

- ① Clutch spring
- ② Pressure plate
- ③ Pull rod
- ④ Pull lever
- ⑤ Pull lever axle
- ⑥ Friction plate (type A)
- ⑦ Wave plate
- ⑧ Clutch plate
- ⑨ Friction plate (type B)
- ⑩ Clutch boss
- ⑪ Thrust washer
- ⑫ Clutch housing
- ⑬ Primary drive gear

A FRICTION PLATE:		
Type	Thickness	Wear Limit
A 2 pcs.	2.94~3.06 mm (0.116~0.120 in)	2.8 mm (0.110 in)
B 6 pcs.	2.74~2.86 mm (0.108~0.113 in)	2.6 mm (0.102 in)

**B CLUTCH SPRING MINIMUM FREE LENGTH:**  
40.8 mm (1.606 in)

**C CLUTCH PLATE WARPAGE LIMIT:**  
0.2 mm (0.008 in)

**8 Nm (0.8 m•kg, 5.8 ft•lb)**

**6.5 Nm (0.65 m•kg, 4.7 ft•lb)**

**D USE NEW ONE**

**120 Nm (12.0 m•kg, 85 ft•lb)**

**90 Nm (9.0 m•kg, 65 ft•lb)**

**D USE NEW ONE**

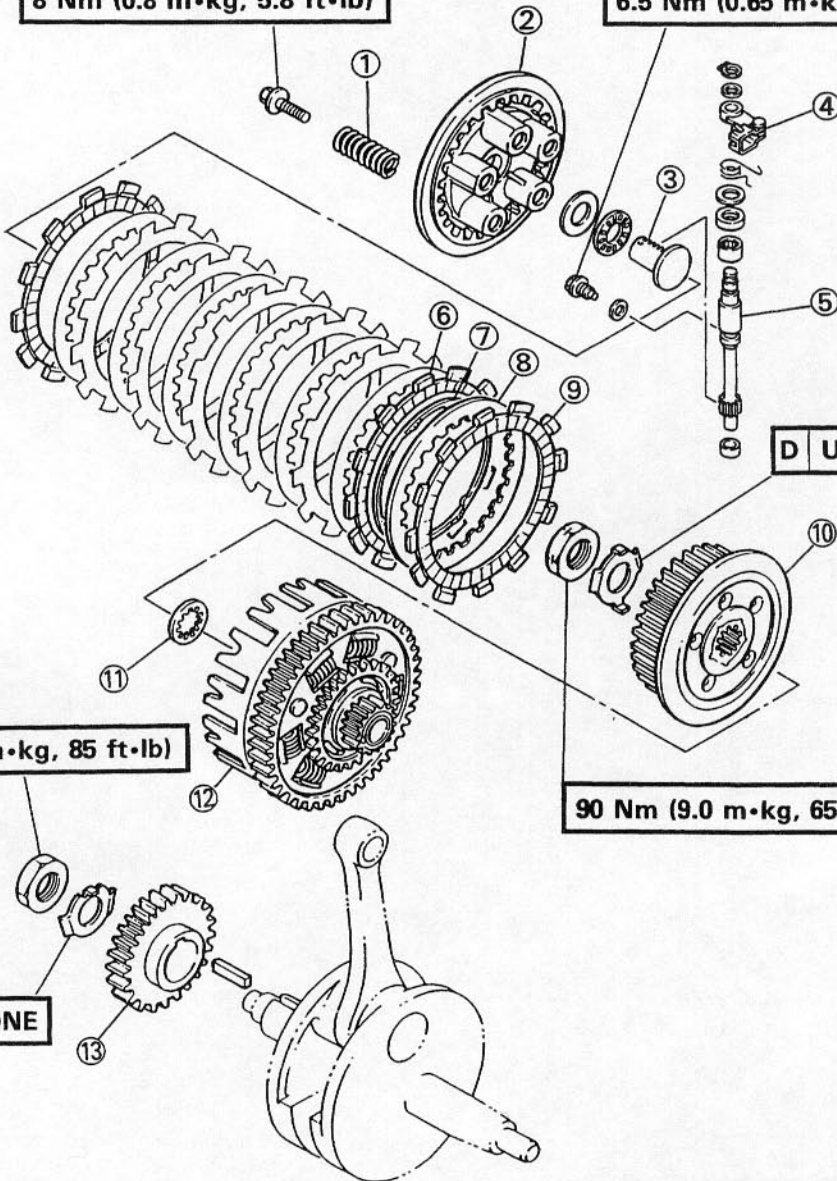

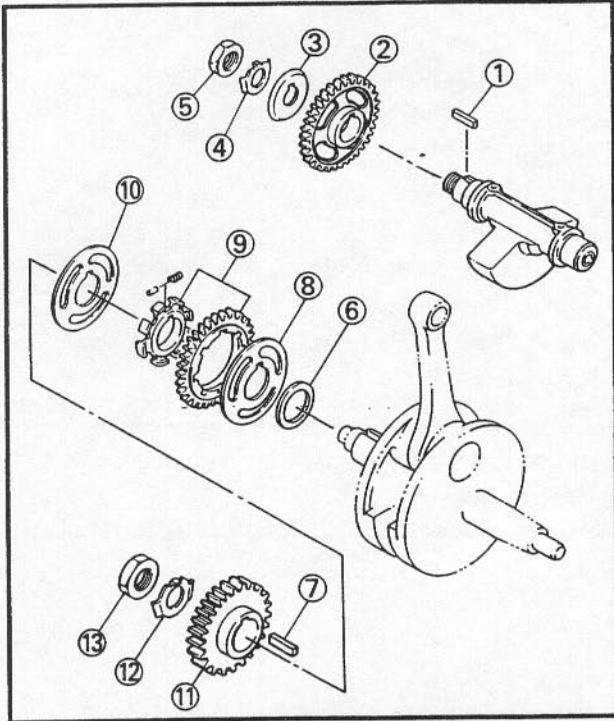

### CLUTCH AND BALANCER GEAR

#### 1. Install:

- Key ①
- Balancer gear ②
- Plate ③
- Lock washer ④
- Nut ⑤ (balancer gear)
- Plate washer ⑥
- Key ⑦
- Plate ⑧
- Balancer drive gear ⑨
- Plate ⑩
- Primary drive gear ⑪
- Lock washer ⑫
- Nut ⑬ (primary drive gear)



**Nut (balancer gear):**

**60 Nm (6.0 m•kg, 43 ft•lb)**

**Nut (primary drive gear):**

**120 Nm (12.0 m•kg, 85 ft•lb)**

#### NOTE:

- When installing the drive gear, align the punched mark ⑭ on the drive gear with the punched mark ⑮ on the balancer gear.
- Place a folded rag or aluminum plate between the teeth of the balancer drive gear and balancer gear.
- Take care not to damage the gear teeth.

2. Bend the lock washer tab along the nut flats ⑯.

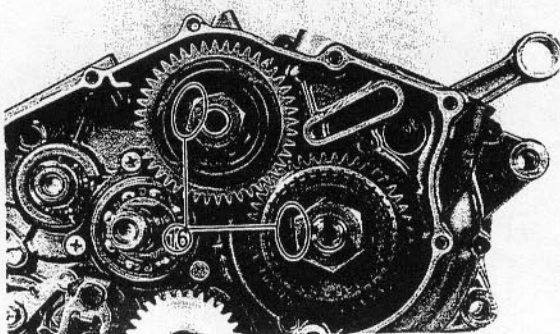
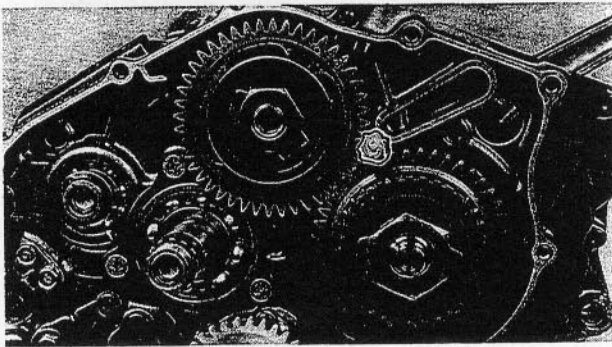
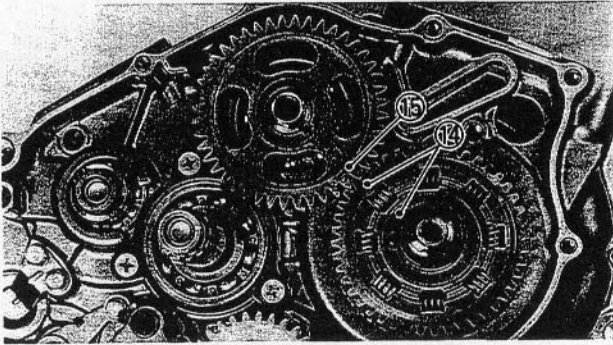

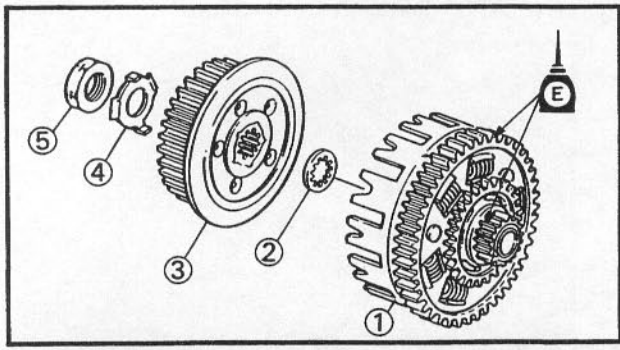

3. Apply:  
 •Engine oil  
 (onto bearing and gear teeth)

4. Install:  
 •Clutch housing ①  
 •Thrust plate ②  
 •Clutch boss assembly ③  
 •Lock washer ④  
 •Nut ⑤ (clutch boss)

**NOTE:** \_\_\_\_\_  
 Fit the tabs of the lock washer to the groove of the clutch boss.  
 \_\_\_\_\_

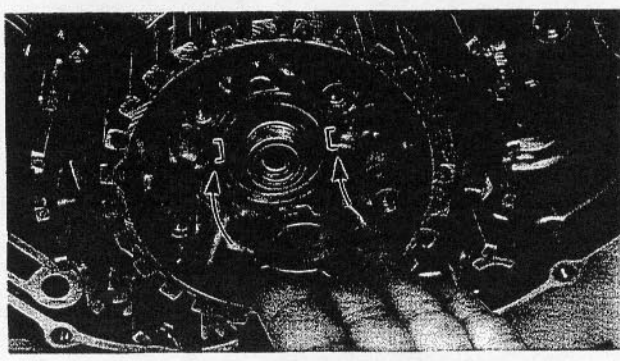

5. Tighten:  
 •Nut ① (clutch boss)

**NOTE:** \_\_\_\_\_  
 Tighten the nut (clutch boss) while holding the clutch boss with the universal clutch holder ②.  
 \_\_\_\_\_

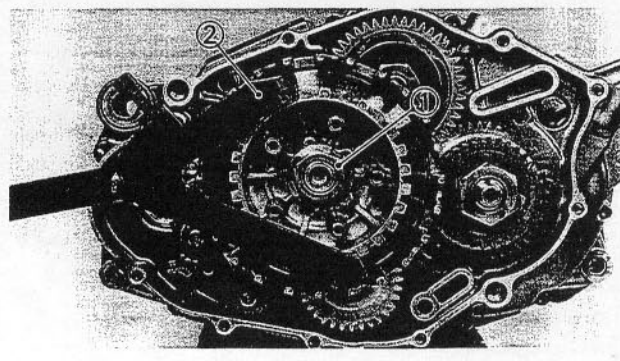

	<b>Universal clutch holder:</b> <b>P/N. YM-91042, 90890-04086</b>
---	--

	<b>Nut (clutch boss):</b> <b>90 Nm (9.0 m•kg, 65 ft•lb)</b>
---	--

6. Bend:  
 •Lock washer tab  
 (along nut flat)

7. Apply:  
 •Molybdenum disulfide grease  
 (onto gear teeth of pull rod)  
 •Engine oil  
 (onto bearing (pull rod))





### 8. Install:

- Friction plate ①
- Clutch plates ②
- Cushion spring ③
- Pull rod ④
- Bearing ⑤ (pull rod)
- Washer ⑥
- Pressure plate ⑦
- Clutch spring ⑧
- Bolts ⑨

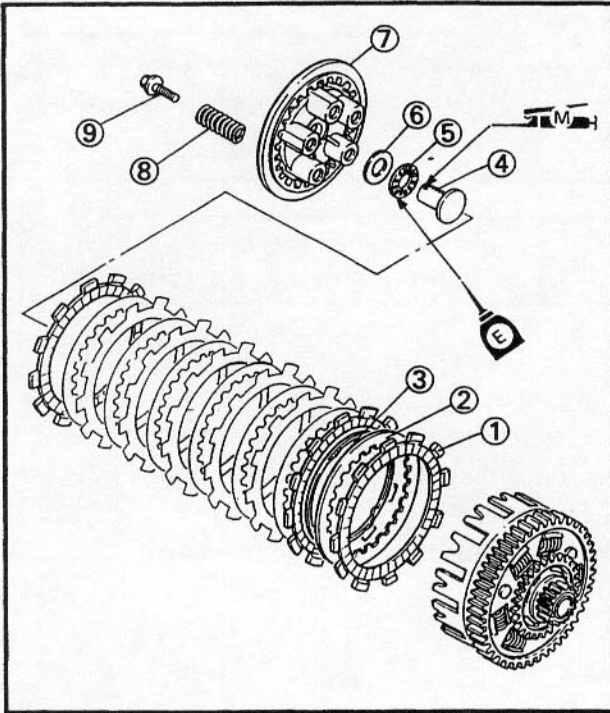

### NOTE:

Install the clutch plates and friction plates alternately on the clutch boss, starting with a friction plate and ending with a friction plate.

### CAUTION:

- The friction plates (type A) ⑩ with the larger of the inside diameter must be installed in the second and last places.
- The cushion spring ⑪ must be placed on the inside of the second friction plate.

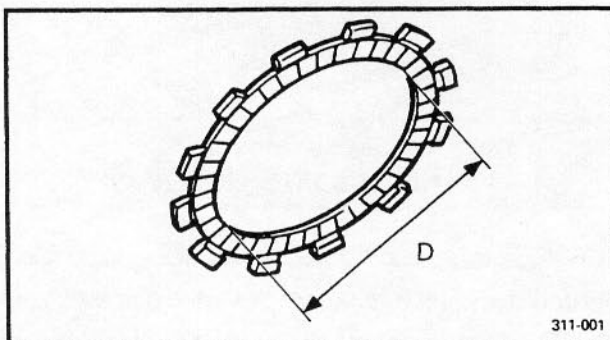
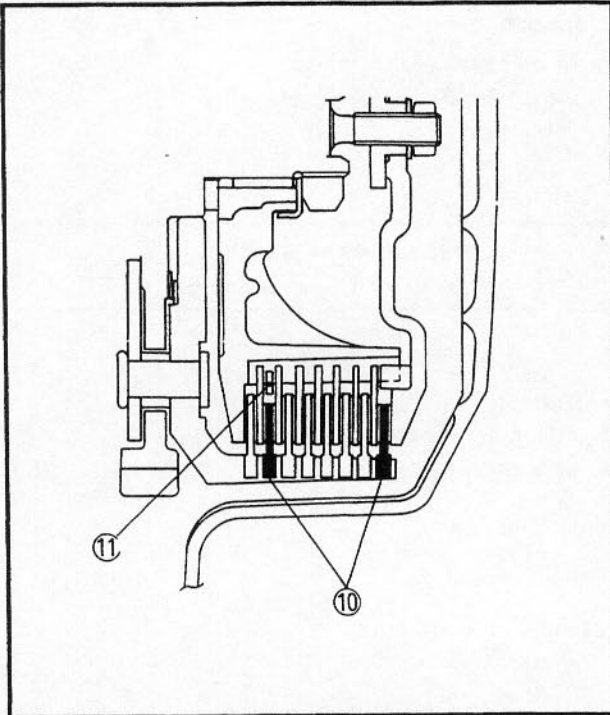

311-001

	Friction Plate	
	Type "A"	Type "B"
Quantity	2 pcs.	6 pcs.
Inside Diameter "D"	116 mm (4.57 in)	113 mm (4.45 in)

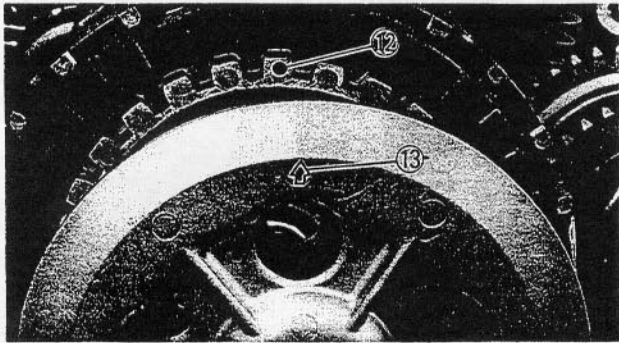

**NOTE:**  
Align the punched mark (12) on the clutch boss with the arrow mark on the clutch pressure plate (13).

 **Bolt (pressure plate):**  
8 Nm (0.8 m•kg, 5.8 ft•lb)

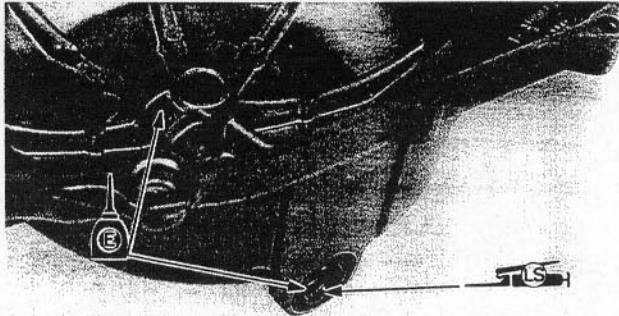

9. Apply:
- Lithium soap base grease (onto oil seal lips in crankcase cover)
  - Engine oil (onto bearings in crankcase cover)

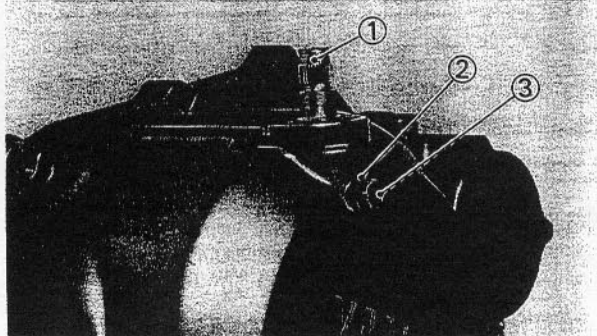

10. Install:
- Pull lever axle (1) (into crankcase cover)
  - Washer (2)
  - Bolt (3)

 **Bolt (pull lever axle):**  
6.5 Nm (0.65 m•kg, 4.7 ft•lb)

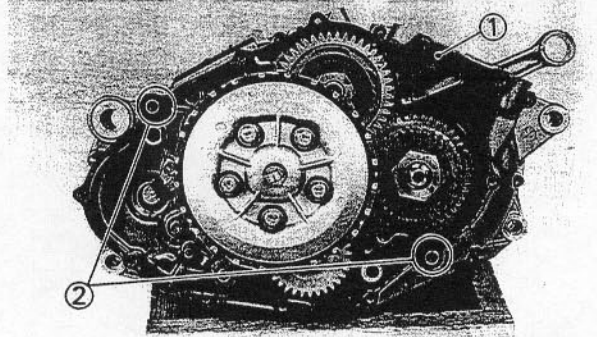

11. Install:
- Gasket (1) (crankcase cover)
  - Dowel pins (2)

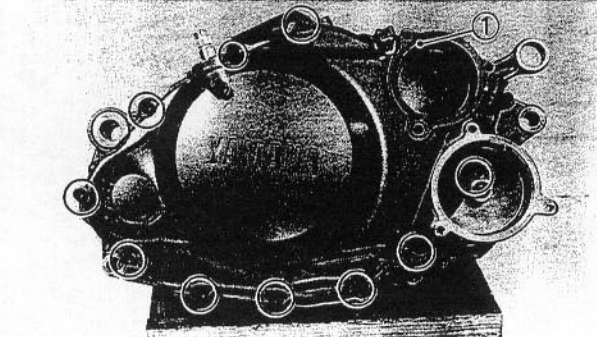

12. Install:
- Crankcase cover (1) (right)

 **Bolt (crankcase cover):**  
10 Nm (1.0 m•kg, 7.2 ft•lb)

**NOTE:**  
Tighten the bolts (crankcase cover) in a crisscross pattern.

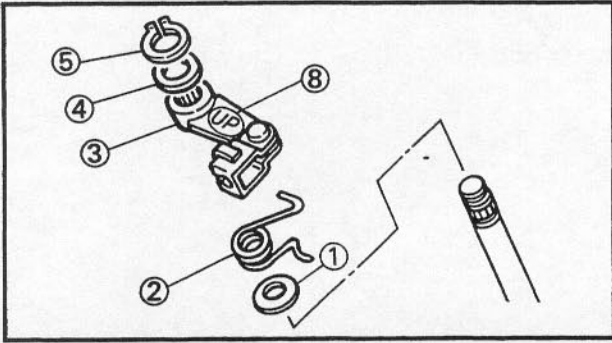

13. Install:

- Washer ①
- Return spring ②
- Pull lever ③
- Washer ④
- Circlip ⑤

**NOTE:**

- Make sure that the mark ⑥ on the pull lever is aligned with the embossed mark ⑦ on the crankcase while pushing the pull lever. If not, change the pull lever position.
- Install the pull lever with the "UP" mark ⑧ facing upward.

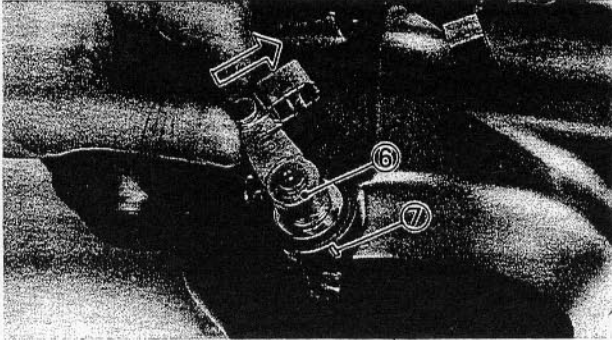

## OIL FILTER AND WATER PUMP

1. Install:

- Impeller shaft ①
- Water pump housing ②
- Circlip ③
- Pin ④
- Water pump gear ⑤
- Circlip ⑥

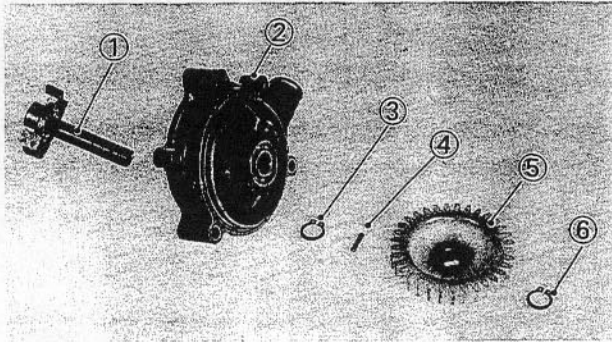

**NOTE:**

Install the water pump gear with embossed side ⑦ facing to inside.

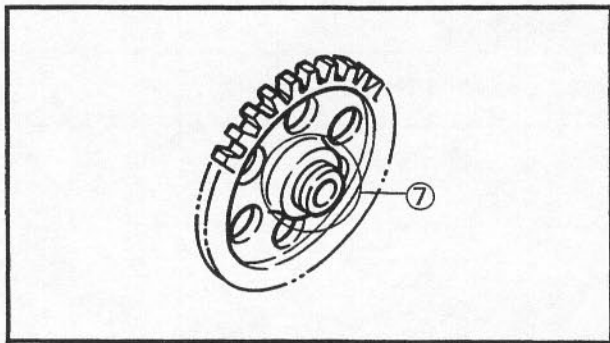

2. Apply:

- Molybdenum disulfide grease (onto impeller shaft end).

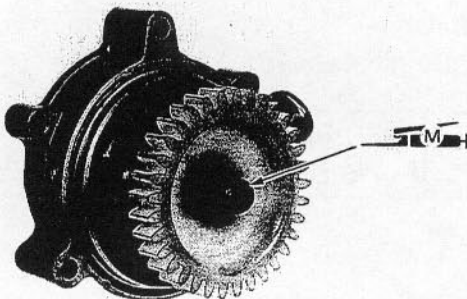



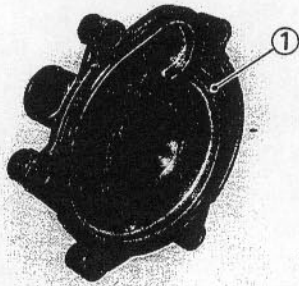

3. Install:
- O-ring ①

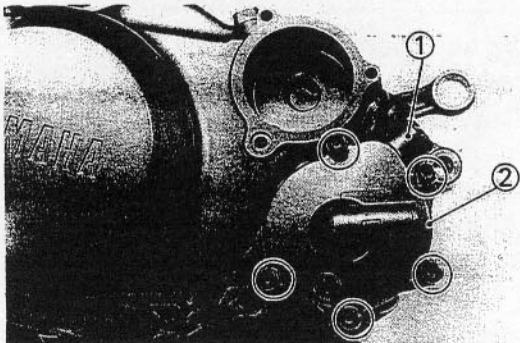

4. Install:
- Water pump housing ①
  - Water pump cover ②

	<b>Bolt (water pump):</b> 10 Nm (1.0 m•kg, 7.2 ft•lb)
---	--

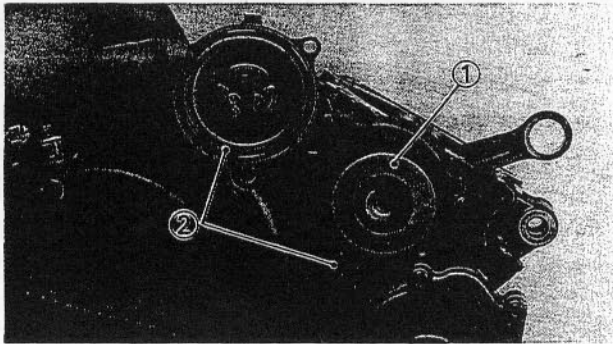

5. Install:
- Oil filter ①
  - O-rings ②

**CAUTION:** \_\_\_\_\_

Install the oil filter as shown.

\_\_\_\_\_

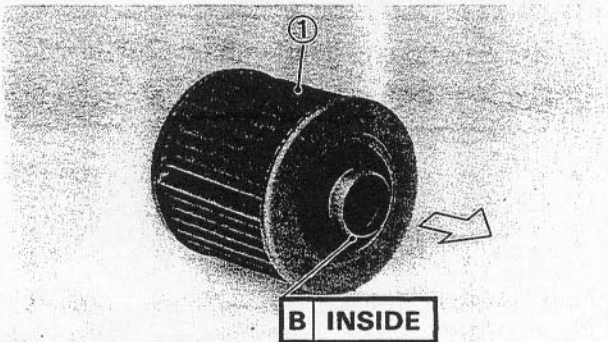

6. Install:
- Oil filter cover ①

	<b>Bolt (oil filter cover):</b> 10 Nm (1.0 m•kg, 7.2 ft•lb)
---	--

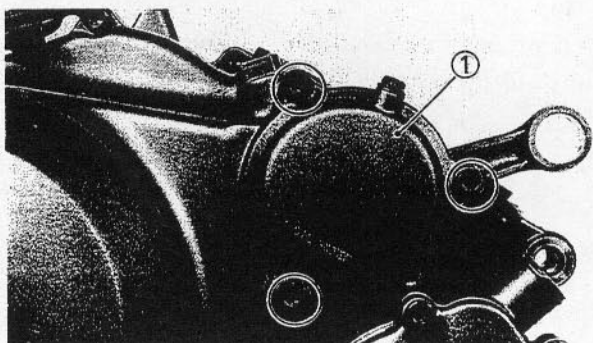



## ROTOR AND STARTER DRIVES

- ① Starter gear
- ② Starter idle gear 1
- ③ Starter idle gear 2
- ④ Starter wheel gear
- ⑤ Starter clutch
- ⑥ Rotor (A.C.G)

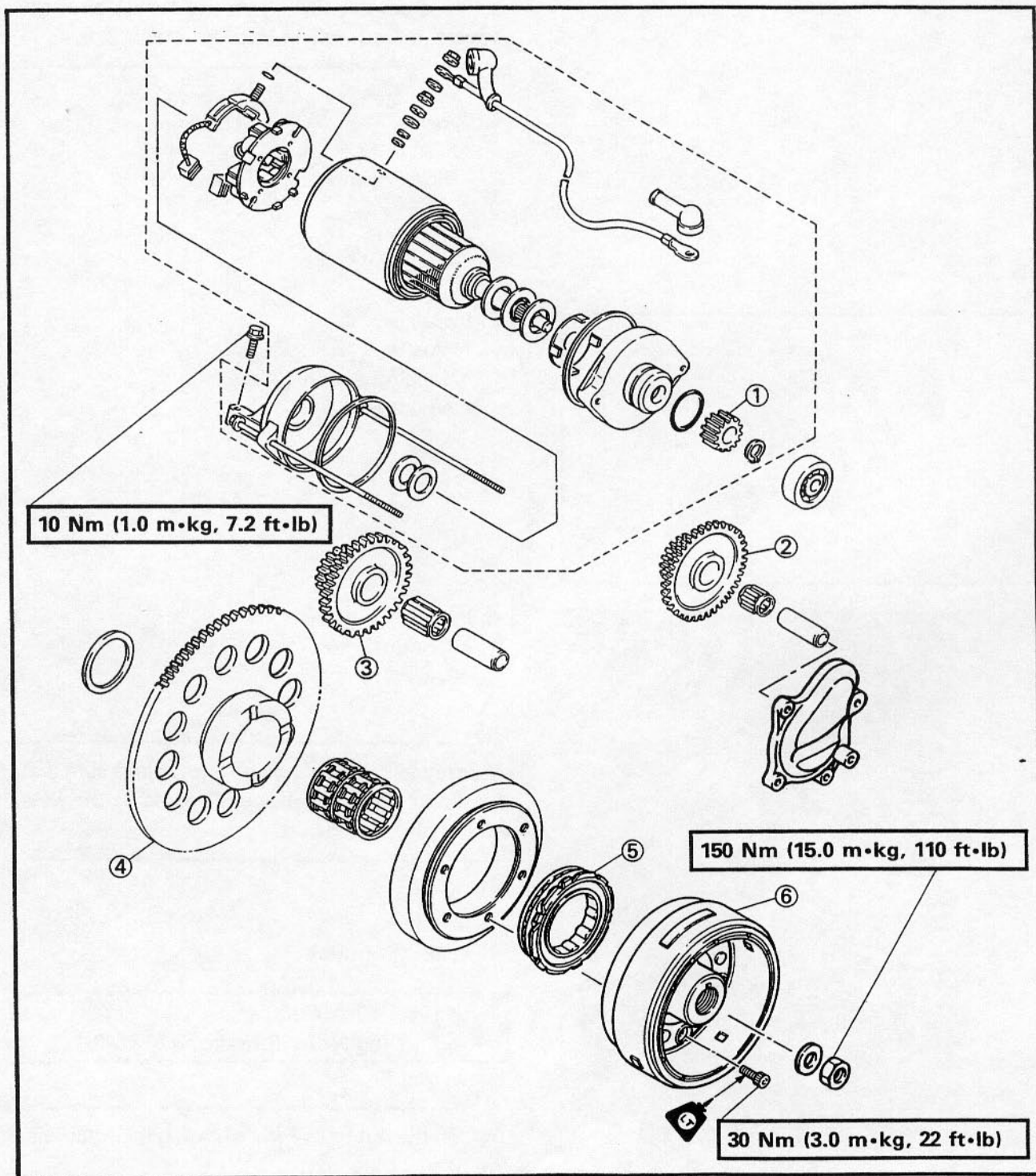

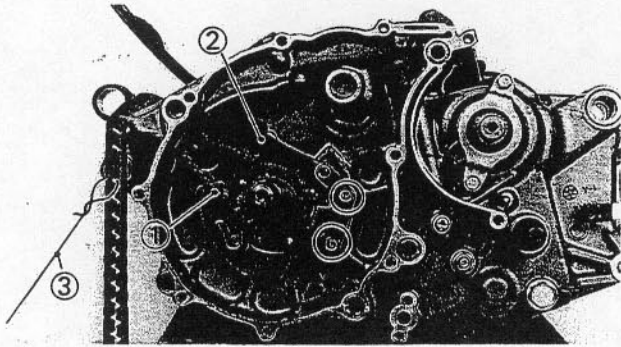

YB344011

**ROTOR AND STARTER DRIVES**

1. Install:
  - Timing chain ①
  - Chain guide ②

	<b>Bolt (chain guide):</b> 10 Nm (1.0 m•kg, 7.2 ft•lb)
---	---

**NOTE:** \_\_\_\_\_  
 Fasten a safety wire ③ to the timing chain to prevent it from falling into the crankcase.

2. Apply:
  - Engine oil  
(onto bearing on starter drives)

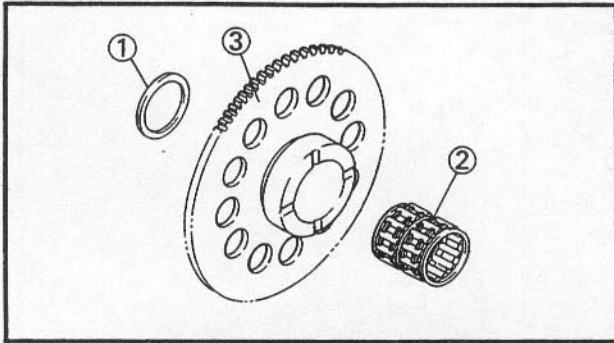

3. Install:
  - Washer ①
  - Needle bearing ②
  - Wheel gear ③

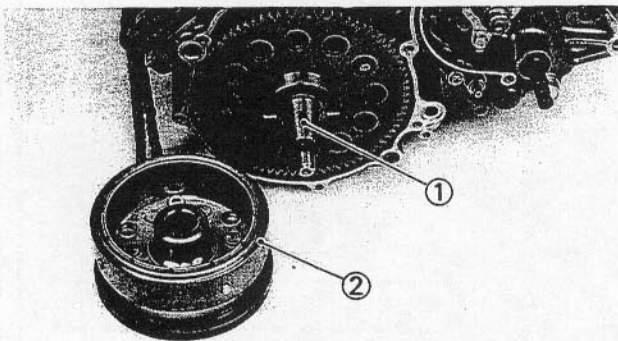

4. Install:
  - Woodruff key ①
  - Rotor ②

**NOTE:** \_\_\_\_\_  
 When installing the magneto rotor, make sure that the woodruff key is properly seated in the keyway of the crankshaft.

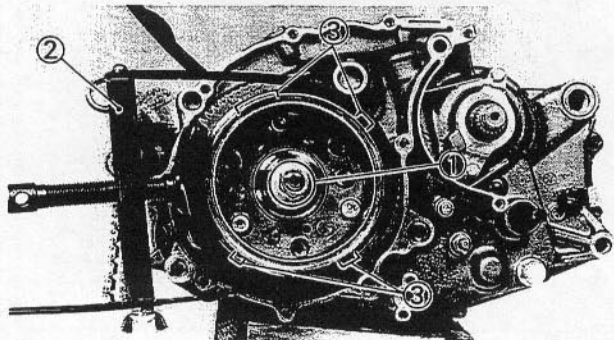

5. Install:
  - Nut ① (rotor)

	<b>Bolt (rotor):</b> 150 Nm (15 m•kg, 110 ft•lb)
---	---

**NOTE:** \_\_\_\_\_  
 Tighten the nut (rotor) while holding the rotor with the rotor holder ②.





**Rotor holder:**

**P/N. YS-01880, 90890-01701**

### CAUTION:

**Do not allow the rotor holder to touch the projections ③ on the rotor.**

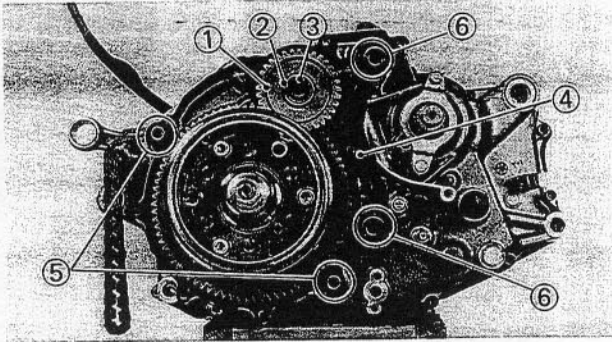

#### 6. Install:

- Starter idle gear 2 ①
- Needle bearing ②
- Shaft ③
- Gasket ④ (crankcase cover)
- Dowel pins ⑤
- O-rings ⑥

#### 7. Install:

- Crankcase cover ① (left)



**Bolt (crankcase cover):**

**10 Nm (1.0 m•kg, 7.2 ft•lb)**

### NOTE:

Tighten the bolts (crankcase cover) in a crisscross pattern.

#### 8. Connect:

- Neutral switch ②

#### 9. Install:

- Shaft ① (starter idle gear)
- Needle bearing ②
- Starter idle gear ③
- Gasket ④
- Dowel pin ⑤

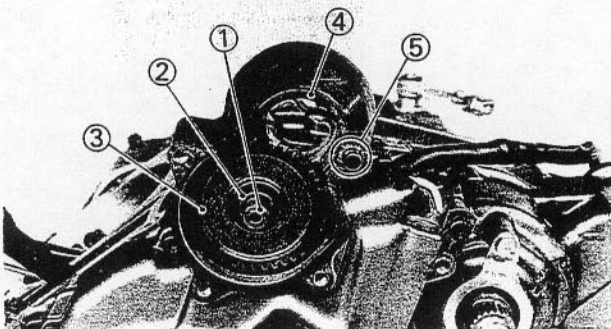

10. Install:  
• Cover ①

 Bolt (cover):  
10 Nm (1.0 m•kg, 7.2 ft•lb)

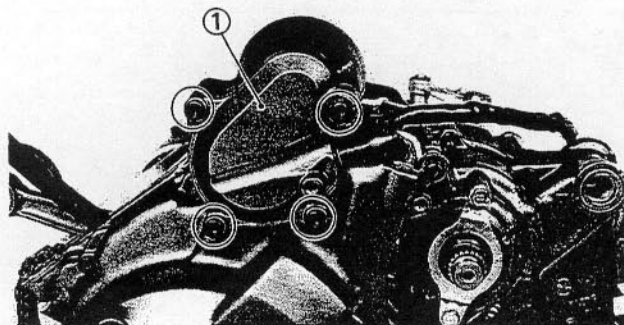



## CYLINDER

- ① Cylinder head gasket
- ② Cylinder
- ③ O-ring
- ④ Cylinder gasket
- ⑤ Dowel pin

### A TIGHTENING SEQUENCE:

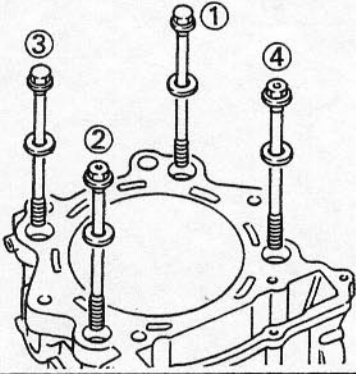

**B BORE SIZE:**  
 100.005 ~ 100.045 mm (3.9372 ~ 3.9388 in)  
**< LIMIT >:**  
 < 100.1 mm (3.941 in) >

**C PISTON-TO-CYLINDER CLEARANCE:**  
 0.050 ~ 0.070 mm (0.0020 ~ 0.0028 in)  
**< LIMIT >:**  
 < 0.15 mm (0.0059 in) >

42 Nm (4.2 m·kg, 30 ft·lb)

10 Nm (1.0 m·kg, 7.2 ft·lb)

D USE NEW ONE

38 Nm (3.8 m·kg, 27 ft·lb)

D USE NEW ONE

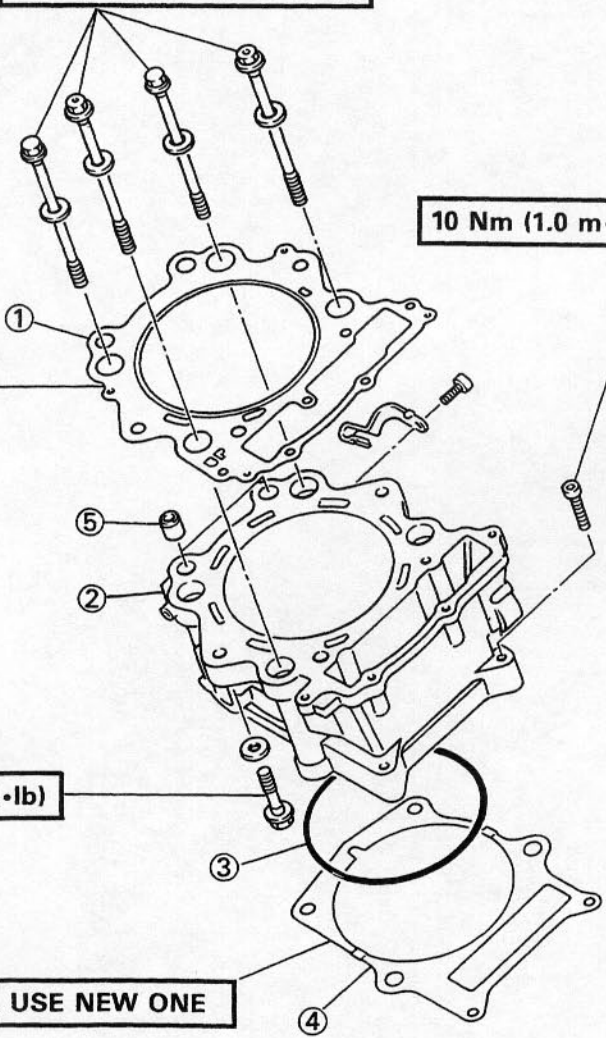





### CYLINDER HEAD

- ① Cylinder head cover
- ② Tappet cover (intake)
- ③ O-ring
- ④ Tappet cover (exhaust)
- ⑤ O-ring
- ⑥ Tachometer gear unit
- ⑦ Cylinder head
- ⑧ Valve guide (intake valve)
- ⑨ Valve guide (exhaust valve)
- ⑩ Spark plug
- ⑪ Dowel pin

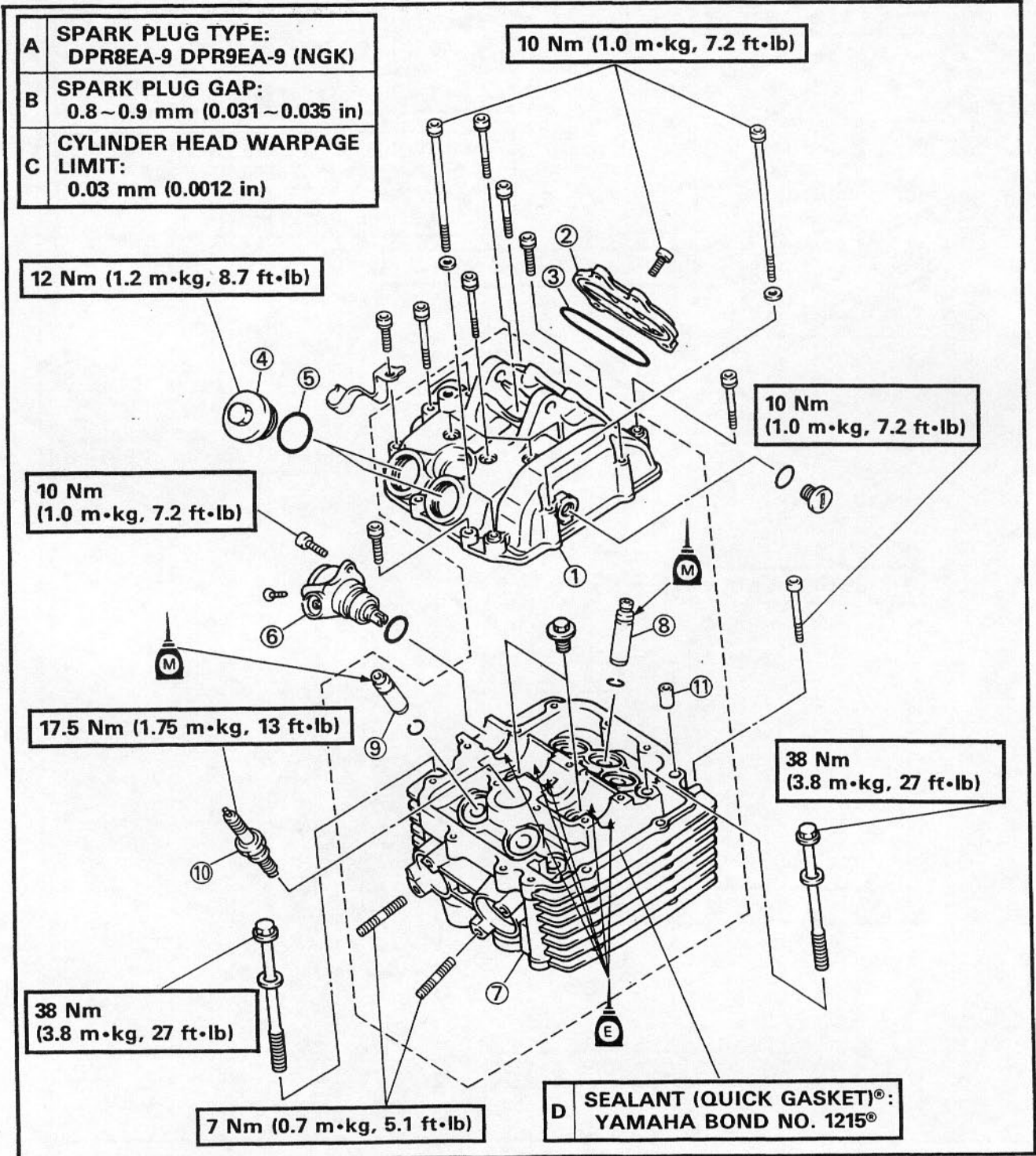



## CAMSHAFT AND TIMING CHAIN

- |                       |                         |
|-----------------------|-------------------------|
| ① Camshaft            | ⑧ Shaft                 |
| ② Spring              | ⑨ Stopper guide plate   |
| ③ Decompression pin   | ⑩ Chain guide (intake)  |
| ④ Decompression lever | ⑪ Timing chain          |
| ⑤ Cam sprocket        | ⑫ Chain guide (exhaust) |
| ⑥ Decompression cam   | ⑬ Gasket                |
| ⑦ Spring              | ⑭ Chain tensioner       |

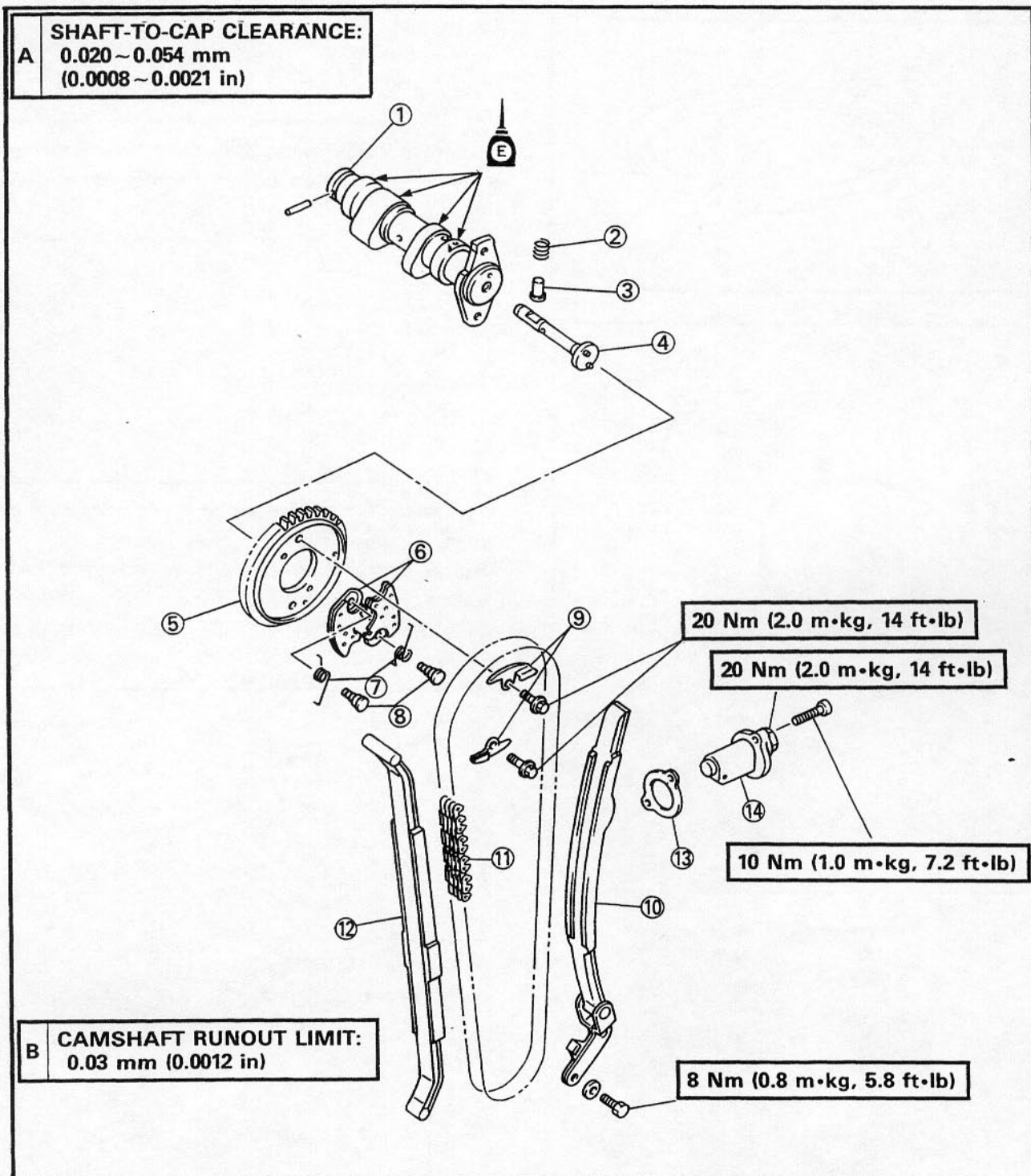



YB344012

## CYLINDER HEAD, CYLINDER AND PISTON

### 1. Apply:

- Engine oil  
(onto piston ring and piston pins)

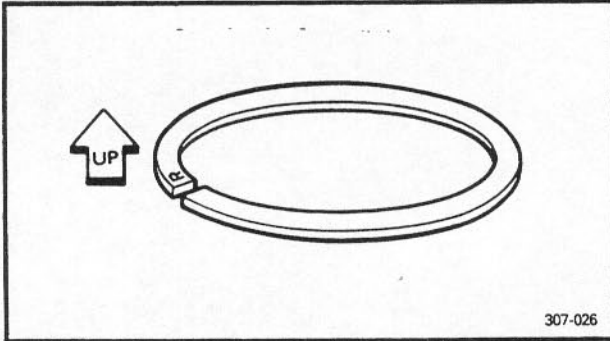

### 2. Install:

- Piston rings

### NOTE:

Be sure to install ring so that manufactures marks or numbers are located on the top side of the rings.

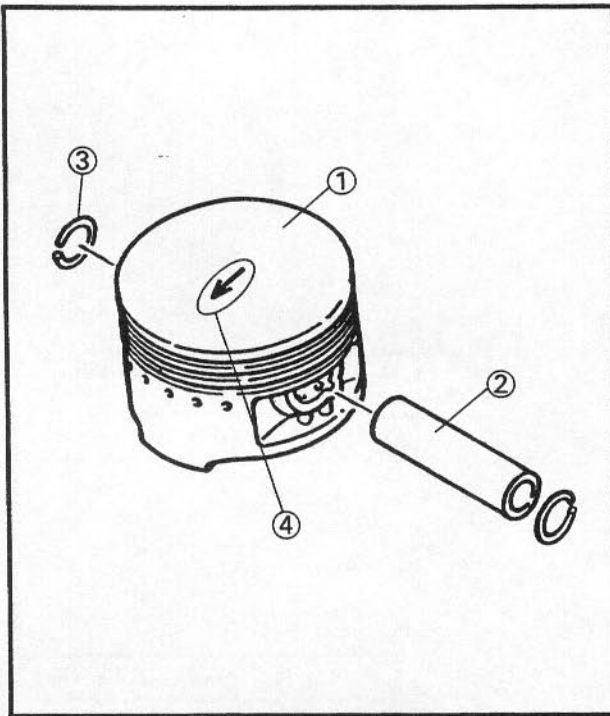

### 3. Install:

- Piston ①
- Piston pin ②
- Circlips ③

### NOTE:

- The allow ④ on the piston must point to the front of the engine.
- Before installing the circlip, cover the crankcase with a clean towel or rag so you will not accidentally drop the pin clip and material into the crankcase.

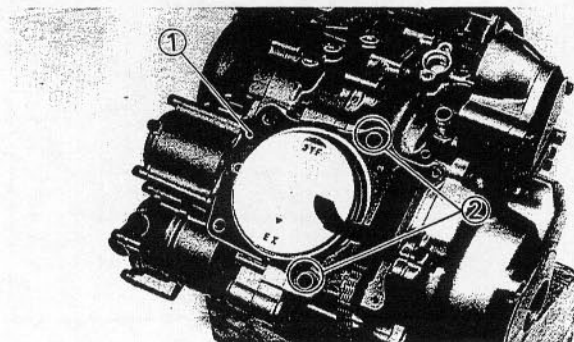

### 4. Install:

- Gasket ① (cylinder)
- Dowel pins ②





### 5. Position:

- Top ring
- 2nd ring

Offset the piston ring end gaps as shown.

- ① Top ring end
- ② Oil ring end (lower)
- ③ Oil ring end (upper)
- ④ 2nd ring end

### 6. Install:

- Cylinder ①

### NOTE:

Install the cylinder while compressing the piston ring by the hand.

### 7. Install:

- Bolts ①
- Bolts ②

	<b>Bolts ①:</b> 42 Nm (4.2 m•kg, 30 ft•lb)
	<b>Bolts ②:</b> 10 Nm (1.0 m•kg, 7.2 ft•lb)

### NOTE:

Tighten the bolts ① in a crisscross pattern.

### 8. Install:

- Pipe ①

	<b>Bolt (pipe):</b> 10 Nm (1.0 m•kg, 7.2 ft•lb)
--	--

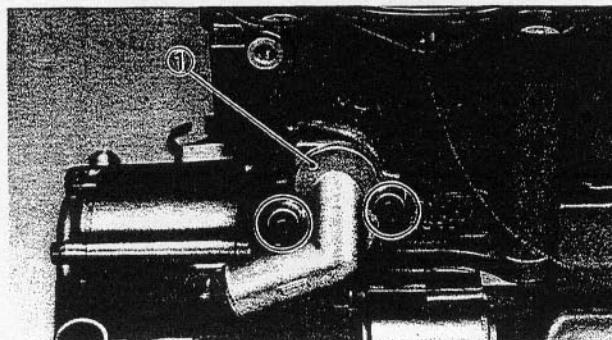
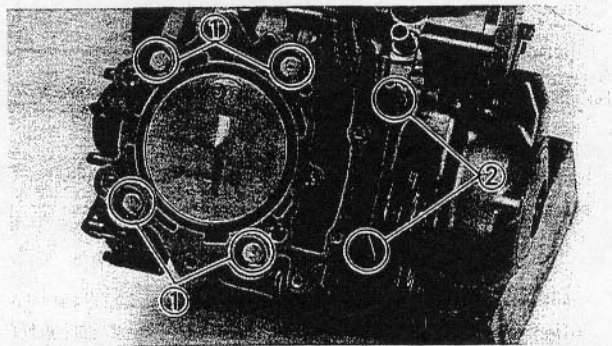
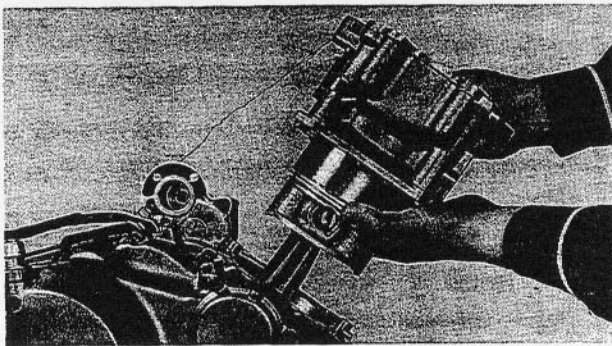
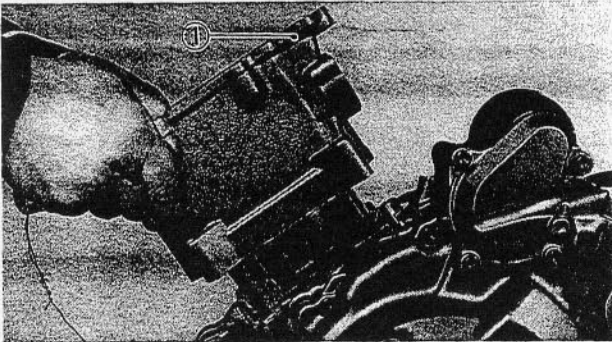
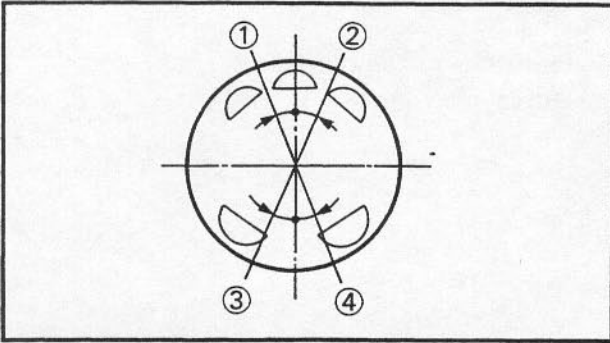

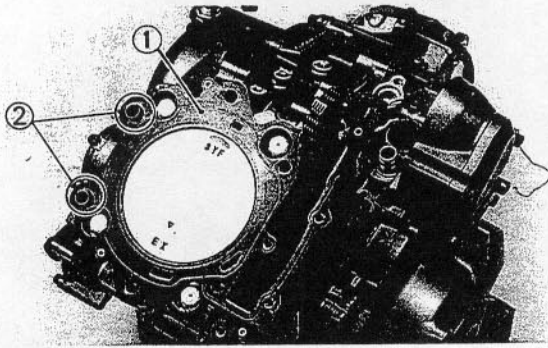

9. Install:

- Gasket ① (cylinder head)
- Dowel pins ②

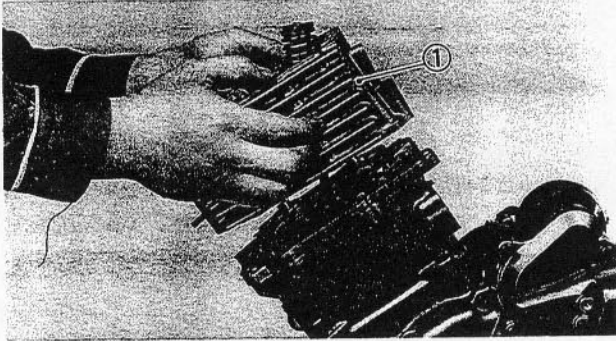

10. Install:

- Cylinder head ①

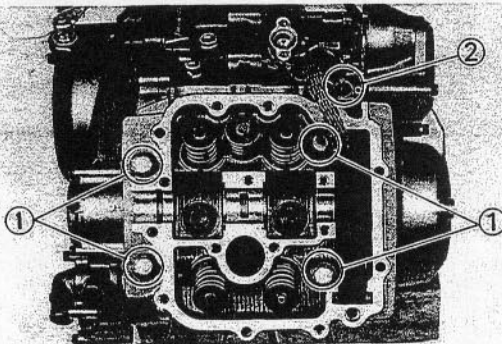

11. Install:

- Bolts ①
- Bolt ②
- Bolts ③
- O-ring (pipe ④)
- Pipe ④



**Bolts ①, ③:**

**38 Nm (3.8 m•kg, 27 ft•lb)**

**Bolt ②:**

**10 Nm (1.0 m•kg, 7.2 ft•lb)**

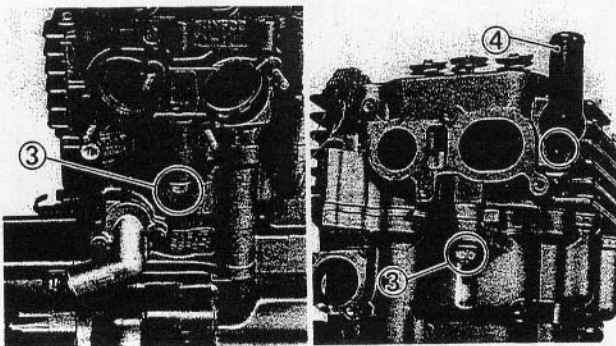

**NOTE:**

- Apply the engine oil onto the O-ring.
- Tighten the bolts ① in a crisscross pattern.

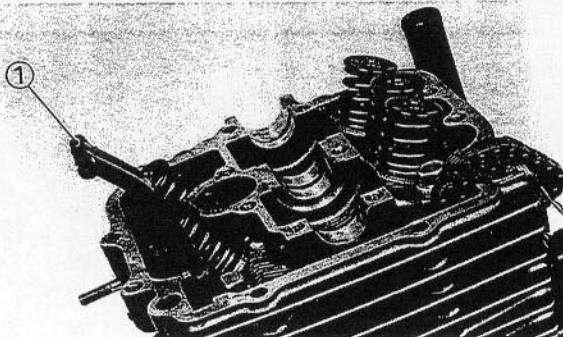

12. Install:

- Chain guide ① (exhaust)





13. Install:

- Cam sprocket ①
- Camshaft ②

\*\*\*\*\*

**Installing steps:**

- Turn the crankshaft counterclockwise until the TDC mark ③ is aligned with the stationary pointer ④.
- Align the match mark ⑤ on the camshaft with the punched mark ⑥ on the decompression lever.
- Fit the timing chain onto cam sprocket and install the cam sprocket on the camshaft.

**NOTE:**

- When installing the cam sprocket, keep the timing chain as tense as possible on the exhaust side.
- Align the pins ⑦ on the decompression lever with the slots ⑧ in the decompression cam.
- Set the respective match marks ⑨ to be parallel with the case surface on the corresponding sides, and align the respective match marks ⑩ to be vertical.

**CAUTION:**

**Do not turn the crankshaft during the camshafts installation. Damage or improper valve timing will result.**

- While holding the camshaft, temporary tighten the bolts.

\*\*\*\*\*

14. Install:

- Chain tensioner ①

\*\*\*\*\*

**Installing steps:**

- Remove the cap bolt ②, washer ③ and spring ④.
- Release the ratchet ⑤ and push the tension rod ⑥.

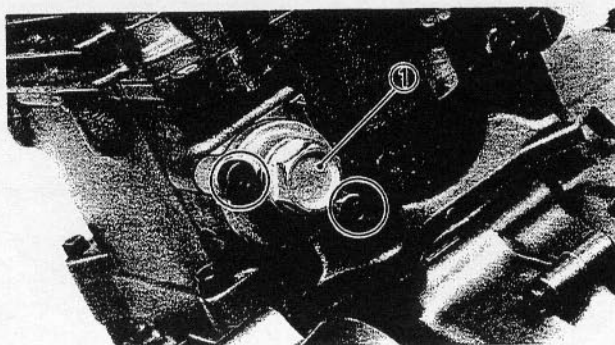
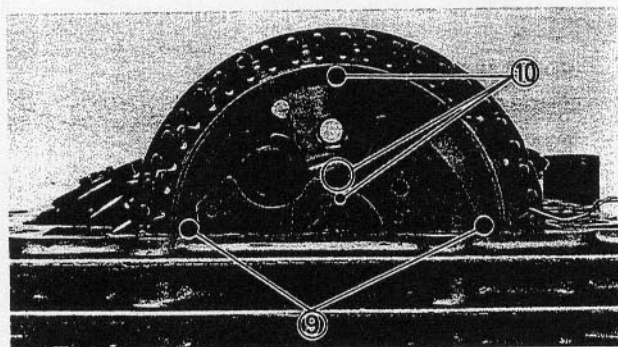
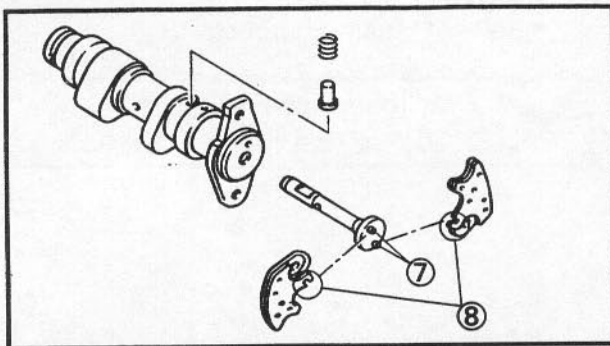
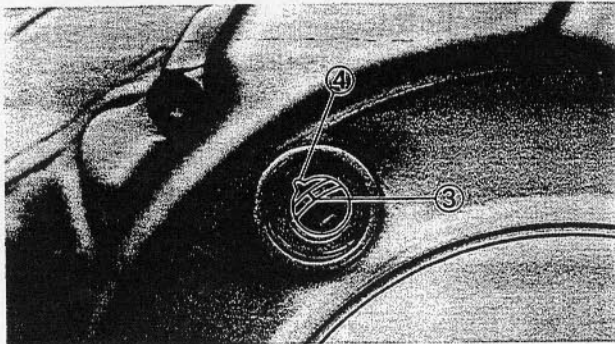
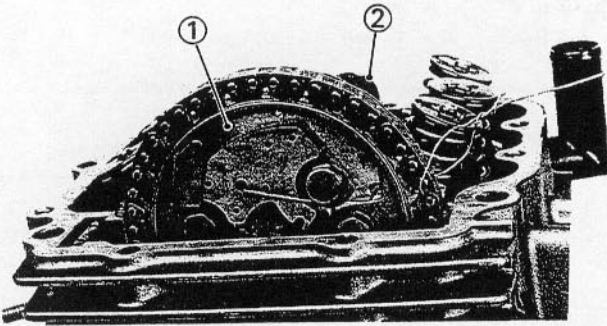



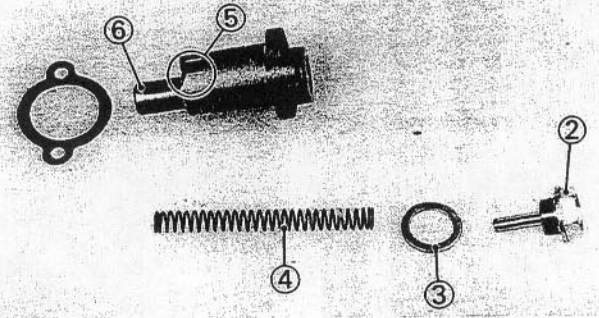

- Install the chain tensioner with the ratchet end facing downward.
- Tighten the bolts.

 **Bolt (chain tensioner):**  
10 Nm (1.0 m•kg, 7.2 ft•lb)

- Install the spring (4), washer (3) and cap bolt (2).

 **Cap bolt (timing chain tensioner):**  
20 Nm (2.0 m•kg, 14 ft•lb)

\*\*\*\*\*

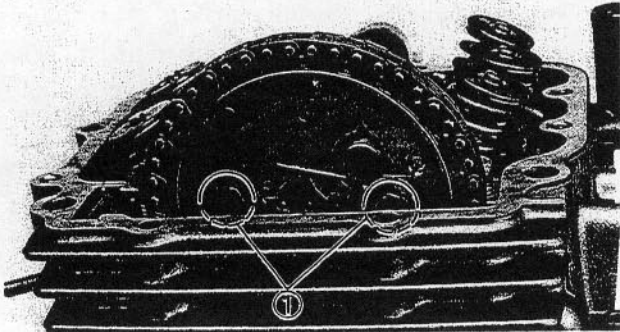

15. Tighten:
- Bolts (1) (cam sprockets)

 **Bolt (cam sprocket):**  
20 Nm (2.0 m•kg, 14 ft•lb)

16. Check:
- Valve timing  
Out of alignment → Adjust.  
Refer to above steps 13 ~ 15.

17. Check:
- Valve clearance  
Out of specification → Adjust.  
Refer to "VALVE CLEARANCE ADJUSTMENT" section in the CHAPTER 3.

 **Install valve (cold):**  
0.10 ~ 0.15 mm (0.004 ~ 0.006 in)  
**Exhaust valve (cold):**  
0.15 ~ 0.20 mm (0.006 ~ 0.008 in)

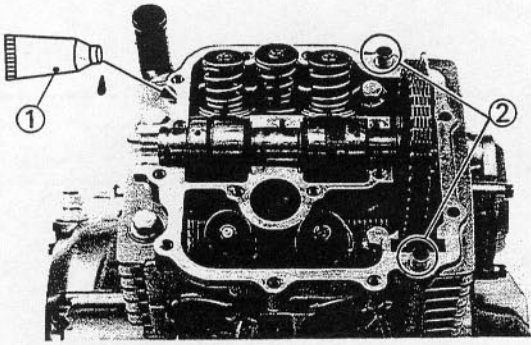

18. Apply:

- Sealant ①

(onto the cylinder head mating surfaces)



**Sealant (quick gasket)®:**  
**P/N. ACC-11001-01**  
**Yamaha Bond No. 1215®:**  
**P/N. 90890-85505**

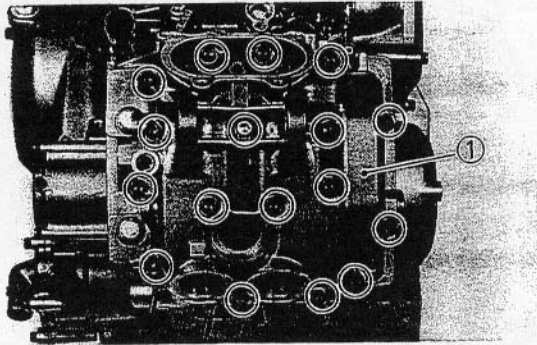

19. Install:

- Dowel pin ②

20. Install:

- Cylinder head cover ①

**NOTE:** \_\_\_\_\_

Tighten the bolts in stage, using a crisscross pattern.



**Bolt (cylinder head cover):**  
**10 Nm (1.0 m•kg, 7.2 ft•lb)**

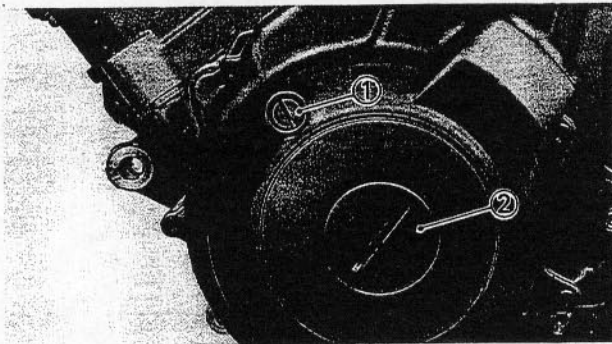

21. Install:

- Timing plug ①
- Plug ②

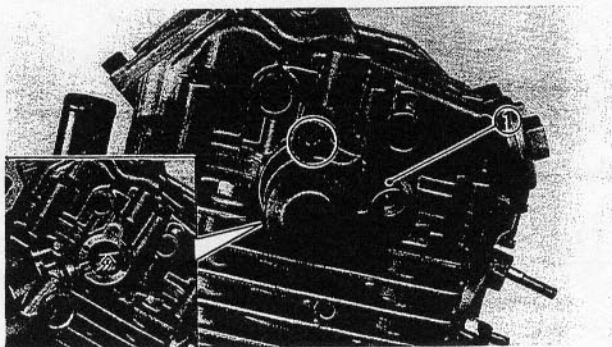

22. Install:

- Tachometer gear unit ①



**Bolt (cylinder head):**  
**10 Nm (1.0 m•kg, 7.2 ft•lb)**

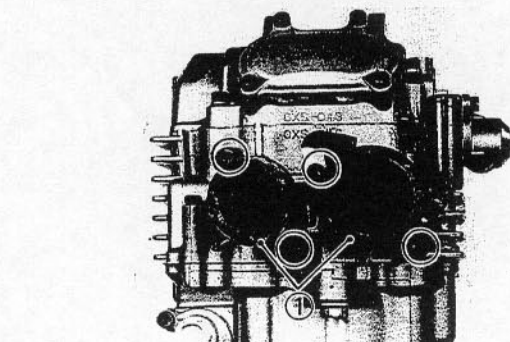

23. Install:

- Intake manifolds ①



**Bolt (intake manifold):**  
**10 Nm (1.0 m•kg, 7.2 ft•lb)**

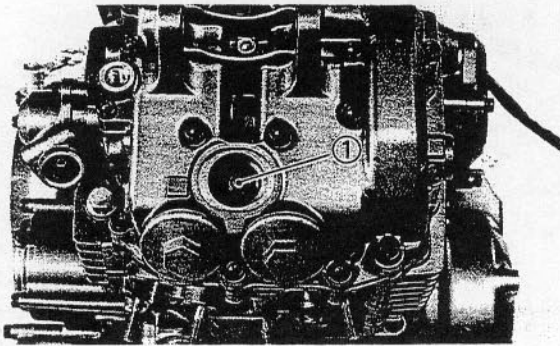

24. Install:

- Spark plug ①



**Spark plug:**

**17.5 Nm (1.75 m•kg, 12.5 ft•lb)**

YB244013

### PIPES AND HOSES

1. Apply:

- Lithium soap base grease  
(onto O-ring on oil pipes)

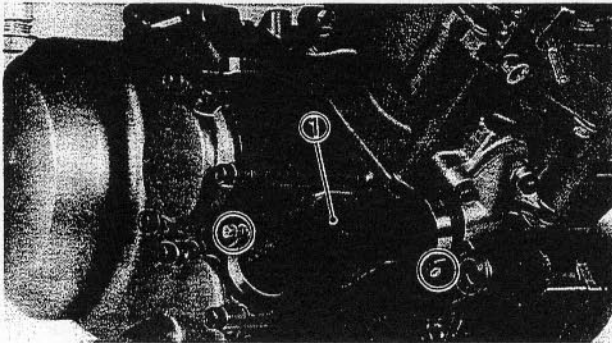

2. Install:

- Coolant hose ①

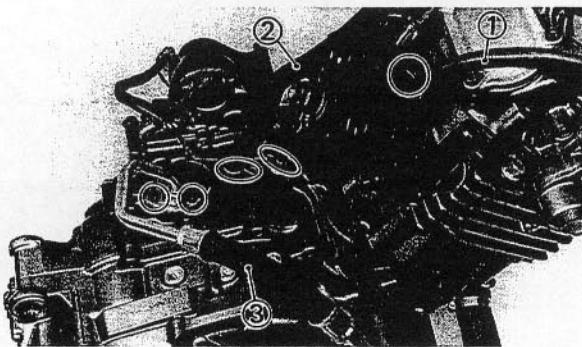

3. Install:

- Breather hose ① (oil tank)
- Breather hose ② (crankcase)
- Oil hose ③



**Bolt (oil hose):**

**10 Nm (1.0 m•kg, 7.2 ft•lb)**

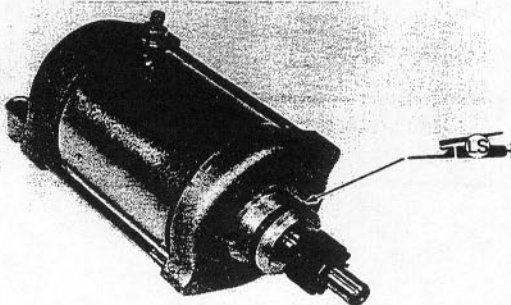

4. Apply:

- Lithium soap base grease (onto O-ring on starter motor)



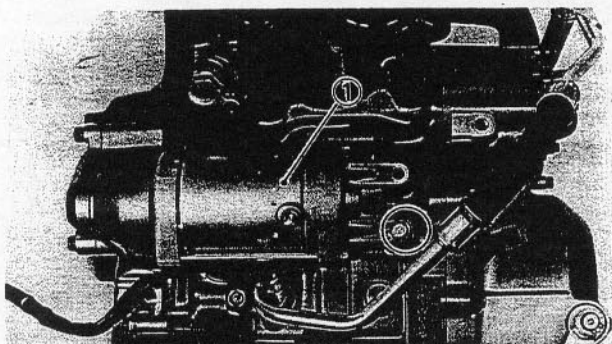

5. Install:

- Starter motor ①



**Bolt (starter motor):**  
10 Nm (1.0 m•kg, 7.2 ft•lb)

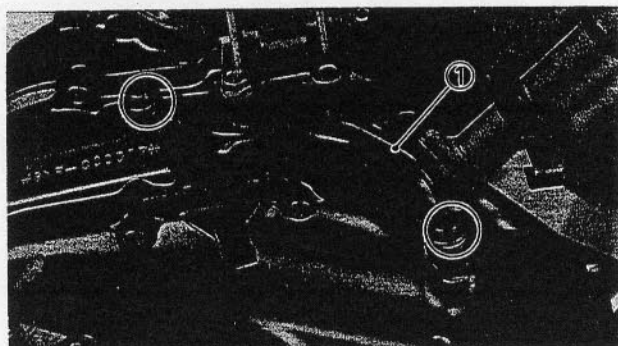

6. Install:

- Oil pipe ①



**Union bolt:**  
20 Nm (2.0 m•kg, 14 ft•lb)

**Bolt:**  
10 Nm (1.0 m•kg, 7.2 ft•lb)

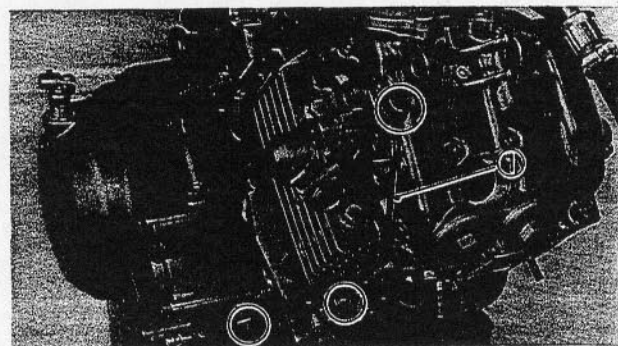

7. Install:

- Oil pipe ①



**Union bolt (oil pipe):**  
20 Nm (2.0 m•kg, 14 ft•lb)

YB244014

## REMountING ENGINE

When remounting the engine, reverse the removal procedure. Note the following points.

1. Install:

- Pivot shaft ①
- Mounting bolt ② (front—upper)
- Mounting bolt ③ (rear—lower)
- Mounting bolts ④ (front—lower)

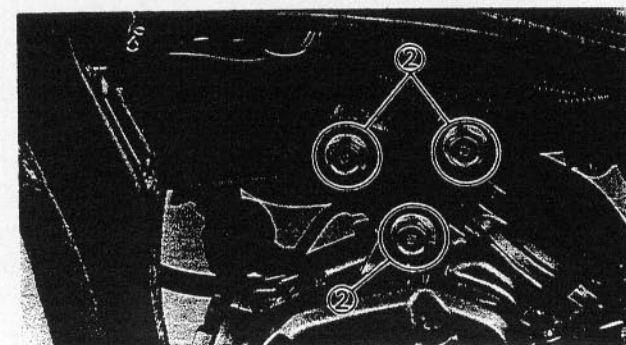
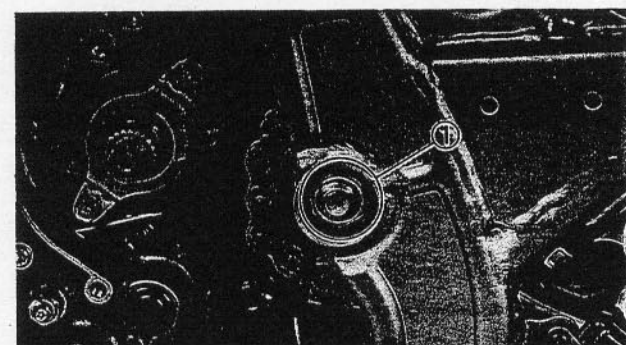

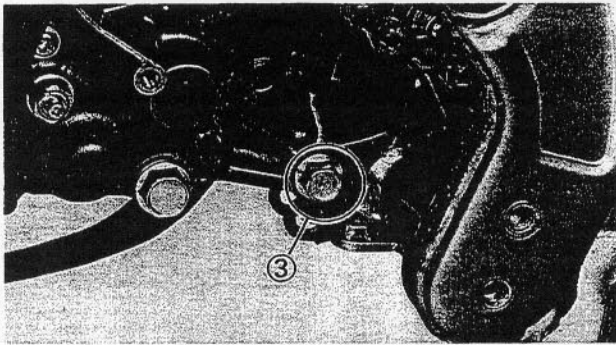

**NOTE:**

Install the all bolts and nuts first, and then tighten the bolts and nuts to specifications.

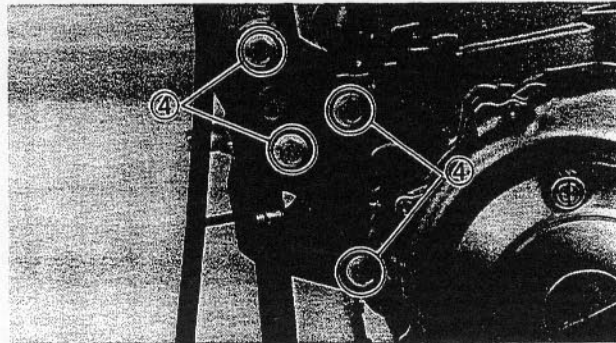

	<b>Nut (pivot shaft):</b>
	<b>100 Nm (10.0 m•kg, 72 ft•lb)</b>
	<b>Nut (mounting bolt):</b>
	<b>Front—upper</b>
	<b>65 Nm (6.5 m•kg, 47 ft•lb)</b>
	<b>Front, Rear—lower</b>
	<b>65 Nm (6.5 m•kg, 47 ft•lb)</b>

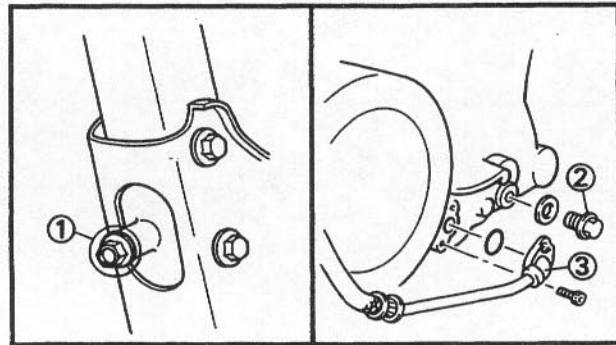

**2. Install:**

- Drain bolt ① (oil tank)
- Drain bolt ② (crankcase)
- Oil hose ③

	<b>Drain bolt ①:</b>
	<b>18 Nm (1.8 m•kg, 13 ft•lb)</b>
	<b>Drain bolt ②</b>
	<b>30 Nm (3.0 m•kg, 22 ft•lb)</b>
	<b>Bolt (oil hose)</b>
	<b>10 Nm (1.0 m•kg, 7.2 ft•lb)</b>

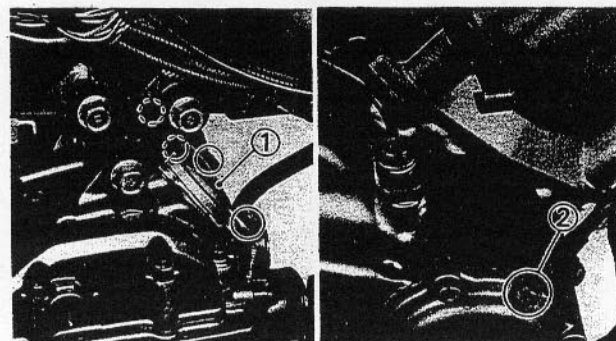

**3. Remove:**

- Tappet cover ① (intake)
- Air bleed screw ② (oil filter cover)

**4. Apply:**

- 4-stroke engine oil  
(to the camshaft upper side and into the oil filter chamber).

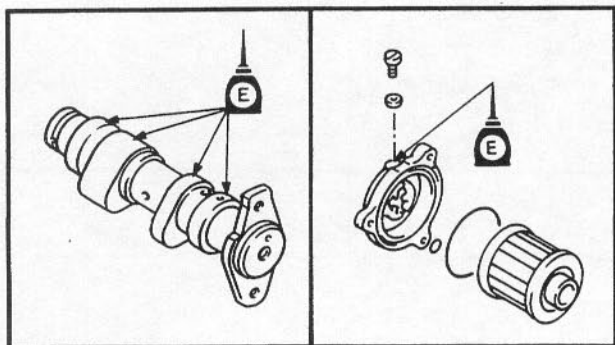

### CAUTION:

Apply a liberal amount of 4-stroke engine oil to the oil passage in the crankcase, or the engine may be damaged.



#### Oil quantity:

##### Camshaft

0.1 L (0.09 Imp qt, 0.11 US qt)

##### Oil filter chamber

0.06 L (0.05 Imp qt, 0.06 US qt)

#### 5. Install:

- Tappet cover (intake)
- Air bleed screw (oil filter cover)



#### Bolt (tappet cover):

10 Nm (1.0 m•kg, 7.2 ft•lb)

#### Bolt (air bleed screw):

5 Nm (0.5 m•kg, 3.6 ft•lb)

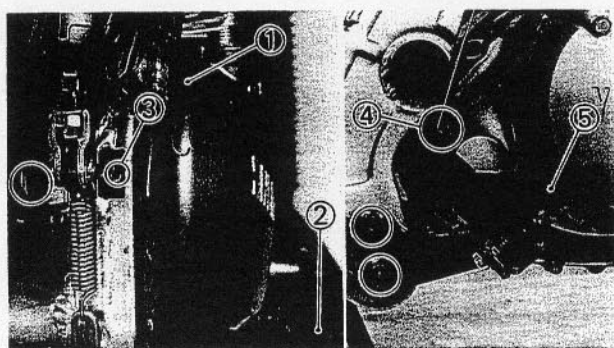

#### 6. Install:

- Pivot shaft cap ① (right and left)
- Rear brake pedal ②



#### Bolt (rear brake pedal):

35 Nm (3.5 m•kg, 25 ft•lb)

#### 7. Connect:

- Clip ③
- Rear brake switch ④

#### 8. Install:

- Footrest ⑤ (right)



#### Bolts (footrest):

50 Nm (5.0 m•kg, 36 ft•lb)



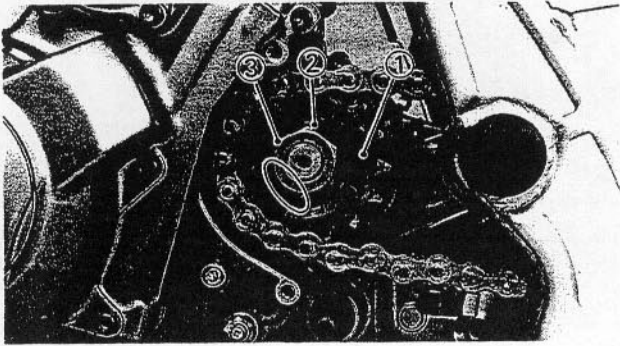

9. Install:

- Drive sprocket ①
- Lock washer ②
- Nut ③



**Nut:**

**110 Nm (11.0 m•kg, 80 ft•lb)**

10. Bend:

- Lock washer tab  
(along nut flat)

11. Adjust:

- Drive chain slack

Refer to the "DRIVE CHAIN SLACK ADJUSTMENT" section in the CHAPTER 3.



**Drive chain slack:**

**20 ~ 45 mm (0.79 ~ 1.77 in)**

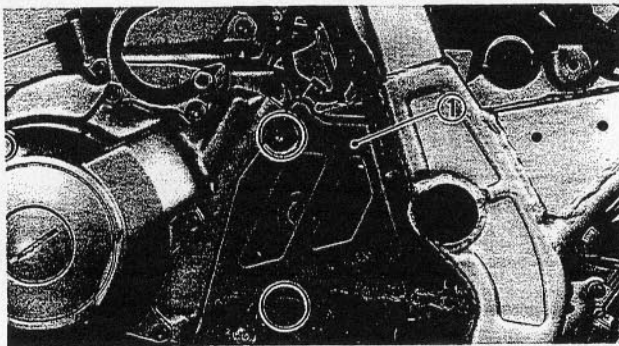

12. Install:

- Cover ①



**Bolt (cover):**

**10 Nm (1.0 m•kg, 7.2 ft•lb)**

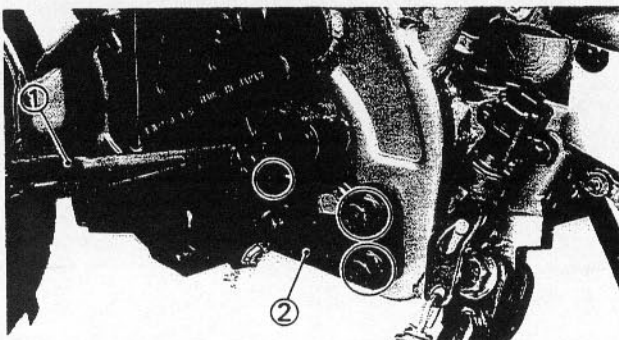

13. Install:

- Shift pedal ①
- Foot rest ② (left)



**Bolt (shift pedal):**

**10 Nm (1.0 m•kg, 7.2 ft•lb)**

**Bolts (foot rest):**

**50 Nm (5.0 m•kg, 36 ft•lb)**

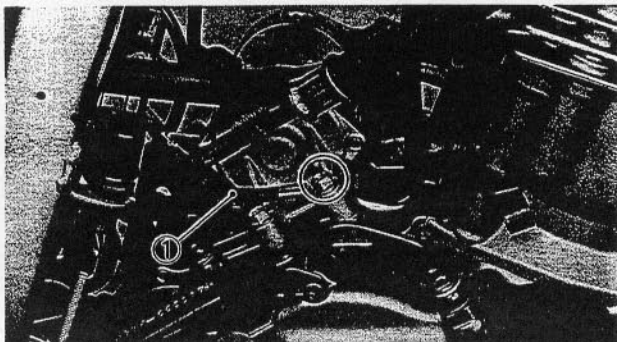

### 14. Connect:

- Ground lead ①

Refer to the "CABLE ROUTING" section in the CHAPTER 2.



#### Bolt:

10 Nm (1.0 m•kg, 7.2 ft•lb)

### 15. Adjust:

- Clutch cable free play

Refer to the "CLUTCH ADJUSTMENT" section in the CHAPTER 3.



#### Free play:

10 ~ 15 mm (0.39 ~ 0.59 in)  
at clutch lever end

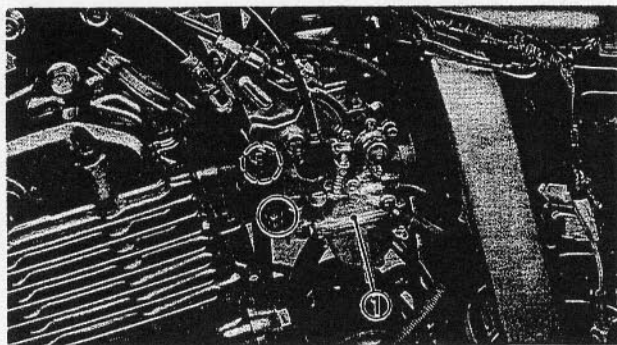

### 16. Connect:

- Carburetors ①



#### Screw (carburetor joint clamp—left):

2 Nm (0.2 m•kg, 1.4 ft•lb)

#### Screw (carburetor joint clamp—right):

5 Nm (0.5 m•kg, 3.6 ft•lb)

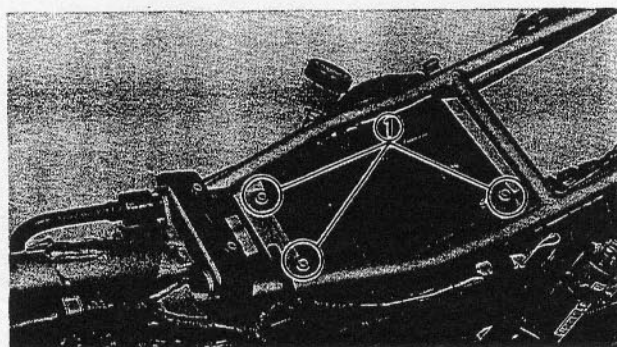

### 17. Install:

- Air filter case ①



#### Bolt (air filter case):

10 Nm (1.0 m•kg, 7.2 ft•lb)

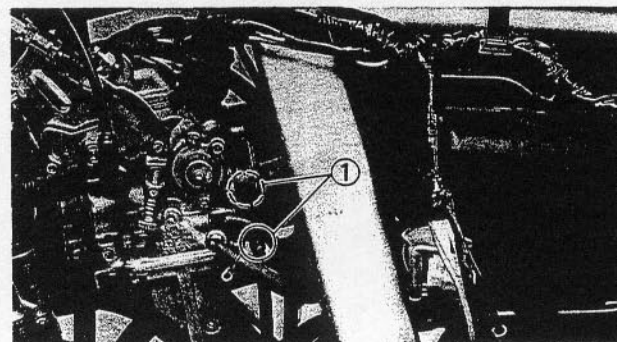

### 18. Connect:

- Carburetor joints ①



#### Screw (carburetor joint clamp—left):

2 Nm (0.2 m•kg, 1.4 ft•lb)

#### Screw (carburetor joint clamp—right):

5 Nm (0.5 m•kg, 3.6 ft•lb)

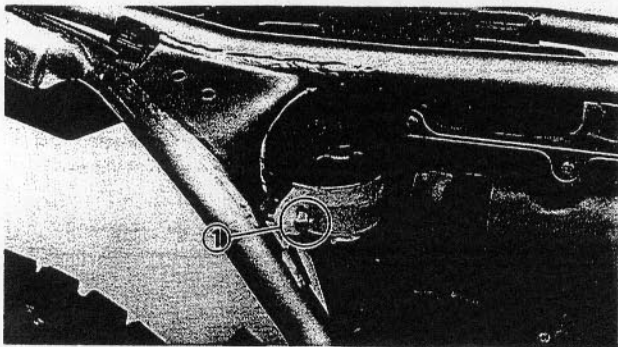

19. Install:

- Bolt (rear brake reservoir tank) ①



**Bolt (rear brake reservoir tank):**  
4 Nm (0.4 m•kg, 2.9 ft•lb)

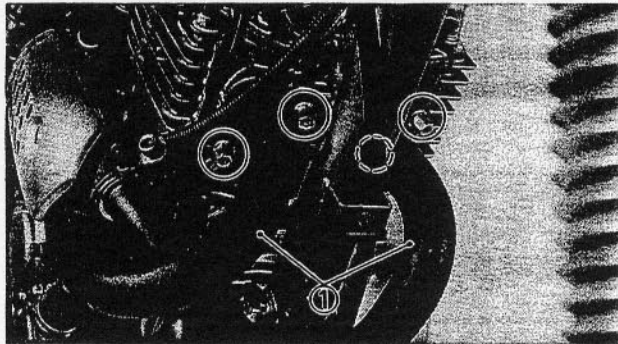

20. Install:

- Exhaust pipes ①
- Muffler ②



**Nut (exhaust pipe):**  
10 Nm (1.0 m•kg, 7.2 ft•lb)

**Bolt (muffler):**

40 Nm (4.0 m•kg, 29 ft•lb)

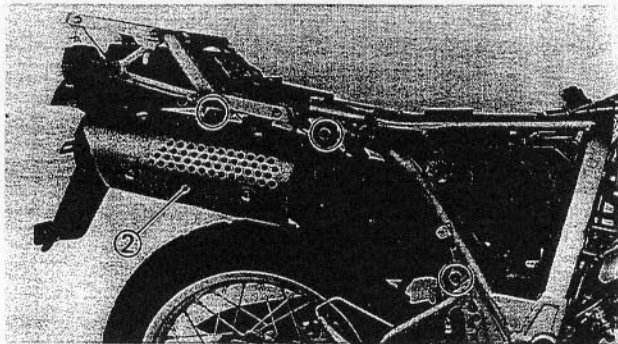

21. Tighten:

- Bolt ① (clamp)
- Bolt ② (clamp)



**Bolt ①, ② (clamp):**  
20 Nm (2.0 m•kg, 14 ft•lb)

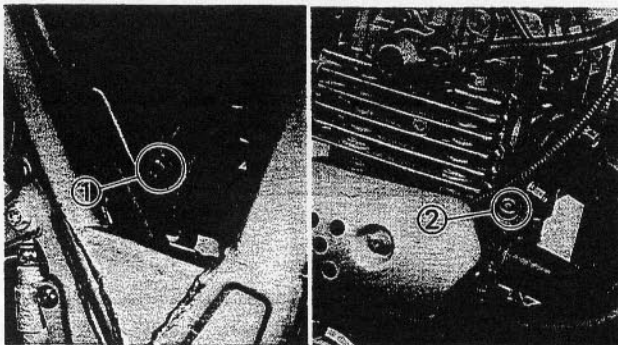

22. Install:

- Radiator ①



**Bolt (radiator):**  
10 Nm (1.0 m•kg, 7.2 ft•lb)

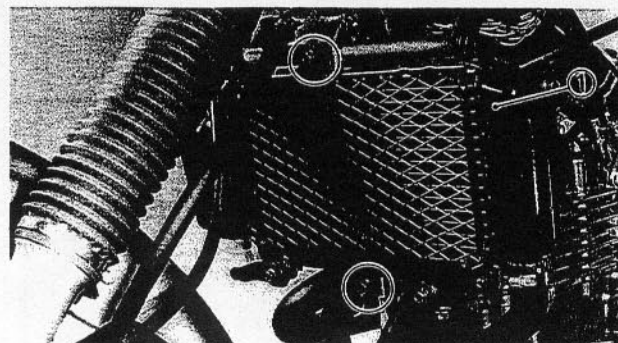



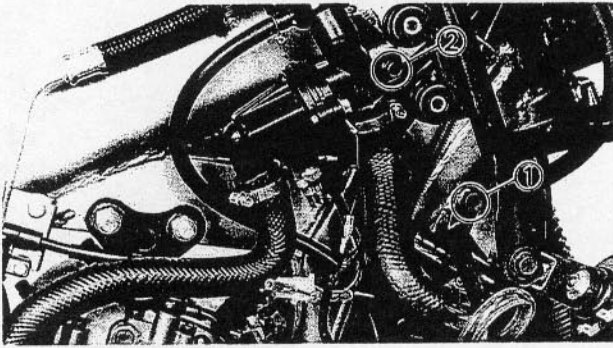

23. Install:

- Bolt ① (radiator stay)
- Bolt ② (conduction)



**Bolt (radiator stay):**

15 Nm (1.5 m•kg, 11 ft•lb)

**Bolt (conduction):**

10 Nm (1.0 m•kg, 7.2 ft•lb)

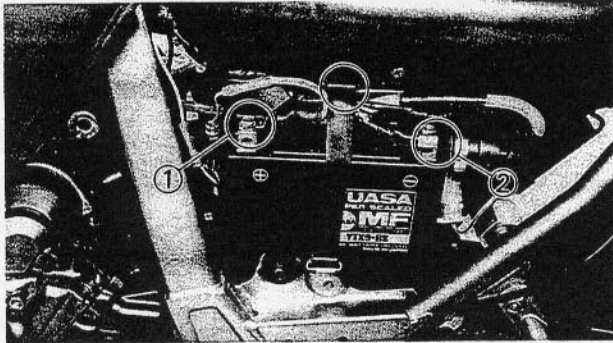

24. Connect:

- Battery leads

**CAUTION:**

Connect the positive lead ① first and then connect the negative lead ②.

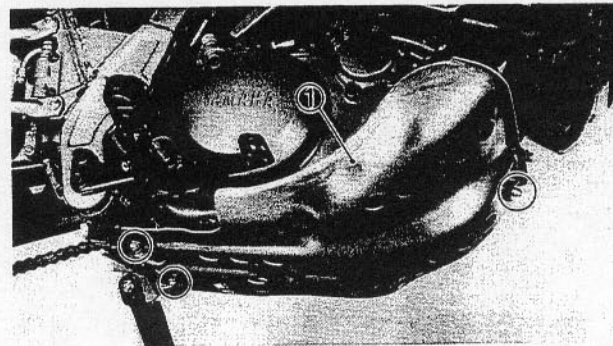

25. Install:

- Engine guard ①



**Nut (engine guard):**

7 Nm (0.7 m•kg, 5.1 ft•lb)

**Bolt (engine guard):**

7 Nm (0.7 m•kg, 5.1 ft•lb)

26. Fill:

- Radiator
- Recovery tank

Refer to the "COOLANT REPLACEMENT" section in the CHAPTER 3.

- Oil tank

Refer to the "ENGINE OIL REPLACEMENT" section in the CHAPTER 3.

27. Install:

- Fuel tank
- Air scoops
- Side covers
- Seat

Refer to the "SEAT, FUEL TANK AND COVER" section in the CHAPTER 3.



**Bolts (fuel tank, cowling and fuel tank, side cover):**

7 Nm (0.7 m•kg, 5.1 ft•lb)

**Bolt (seat):**

10 Nm (1.0 m•kg, 7.2 ft•lb)

---

## CHAPTER 5. COOLING SYSTEM

<b>RADIATOR, WATER PUMP AND THERMOSTAT</b> .....	H-13
<b>RADIATOR</b> .....	H-13
REMOVAL .....	H-13
INSPECTION .....	H-14
ASSEMBLY .....	H-14
<b>WATER PUMP</b> .....	H-15
DISASSEMBLY .....	H-15
INSPECTION .....	H-16
ASSEMBLY .....	H-16
<b>THERMOSTAT</b> .....	H-16
REMOVAL .....	H-16
INSPECTION .....	I-1
ASSEMBLY .....	I-1



**COOLING SYSTEM**

**RADIATOR, WATER PUMP AND THERMOSTAT**

- |                                   |                                      |                   |
|-----------------------------------|--------------------------------------|-------------------|
| ① Recovery tank                   | ⑩ Thermostat                         | ⑲ O-ring          |
| ② Hose                            | ⑪ Thermostat housing                 | ⑳ Drain bolt      |
| ③ Recovery tank cap               | ⑫ Radiator hose (from cylinder head) | ㉑ Gasket          |
| ④ Radiator stay                   | ⑬ Fan motor                          | ㉒ Pin             |
| ⑤ Recovery tank hose              | ⑭ Radiator                           | ㉓ Circlip         |
| ⑥ Radiator hose (from conduction) | ⑮ Radiator protector                 | ㉔ O-ring          |
| ⑦ Conduction                      | ⑯ Radiator hose (to water pump)      | ㉕ Water pump gear |
| ⑧ Radiator cap                    | ⑰ Radiator hose (to cylinder)        |                   |
| ⑨ O-ring                          | ⑱ Water pump assembly                |                   |

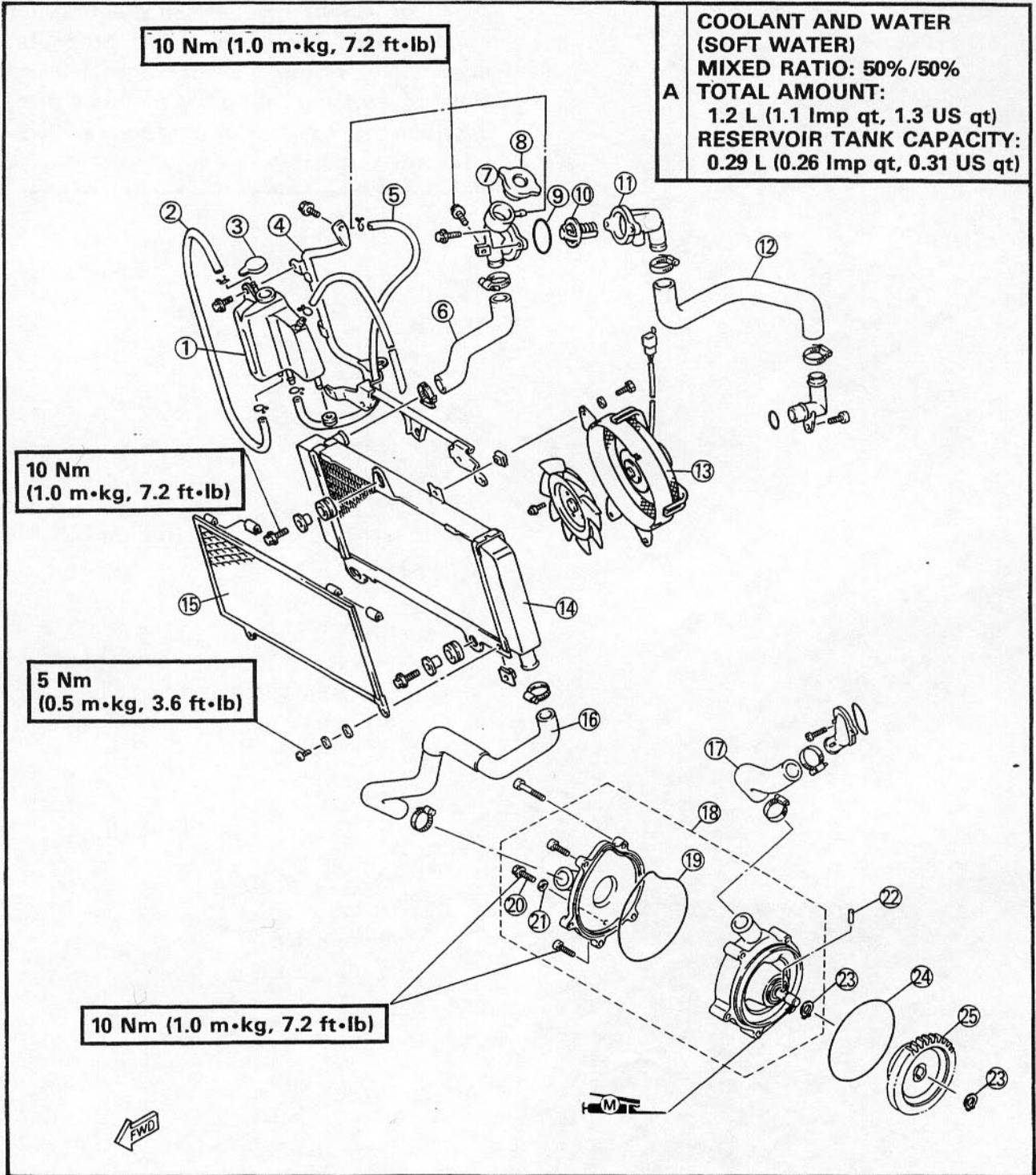





YB251000

**RADIATOR****⚠ WARNING**

Do not remove the radiator cap when the engine and radiator are hot. Scalding hot fluid and steam may be blown out under pressure, which could cause serious injury. When the engine has cooled, open the radiator cap by the following procedure:

Place a thick rag, like a towel, over the radiator cap, slowly rotated the cap counterclockwise to the detent. This procedure allows any residual pressure to escape. When the hissing sound has stopped, press down on the cap while turning counterclockwise and remove it.

YB251001

**REMOVAL**

## 1. Remove:

- Seat
- Side covers
- Air scoops
- Fuel tank
- Engine guard

Refer to the "COOLANT REPLACEMENT" section in the CHAPTER 3.

## 2. Drain:

- Coolant

Refer to the "COOLANT REPLACEMENT" section in the CHAPTER 3.

## 3. Disconnect:

- Fan motor coupler ①

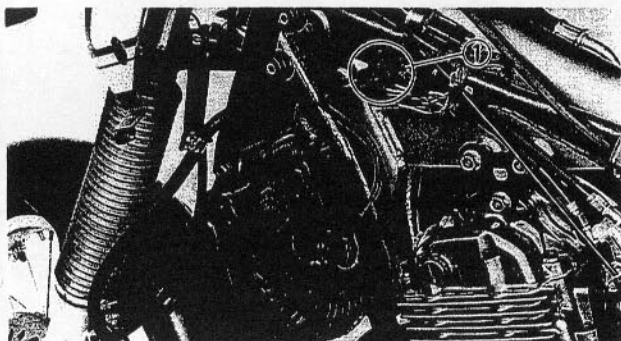

# RADIATOR

COOL

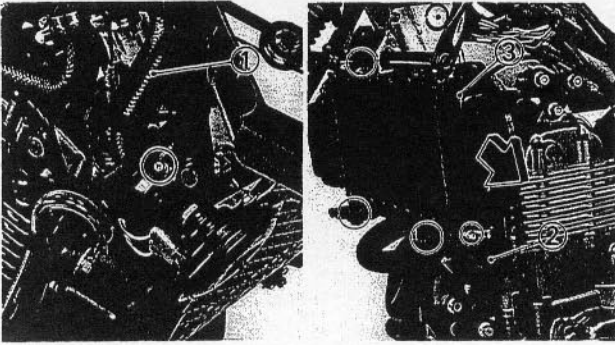

4. Disconnect:
  - Radiator hose ① (from conduction)
  - Radiator hose ② (to water pump)

5. Remove:
  - Radiator assembly ③

6. Remove:
  - Fan motor assembly ①
  - Radiator protector ②

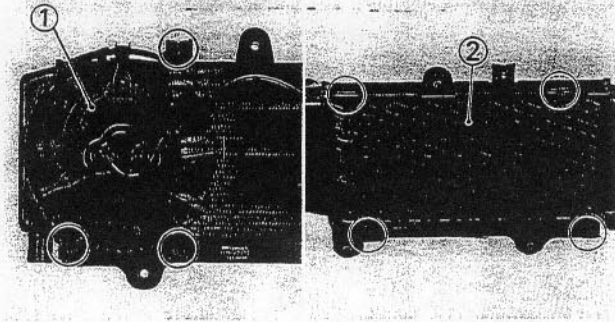

YB351002

## INSPECTION

1. Inspect:
  - Radiator
    - Obstruction → Blow out with compressed air through rear of radiator.
    - Flattened fins → Repair.
  - Coolant hoses
    - Cracks/Damage → Replace.

2. Inspect:
  - Radiator cap
  - Vacuum valve

\*\*\*\*\*

### Inspection steps:

- Measure radiator cap pressure using the radiator cap tester.
- Check vacuum valve for spring tension and seating condition.



**Radiator cap tester:**  
P/N. YU-24460-1, 90890-01325  
**Adapter:**  
P/N. YU-33984, 90890-01352

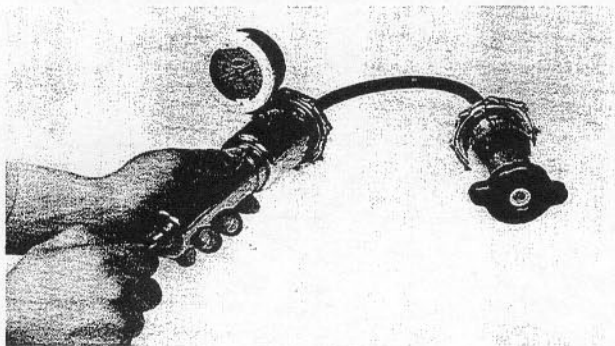



- Valve opens at pressure below specified value or defective → Replace.

**Valve opening pressure:**  
 95 ~ 125 kPa  
 (0.95 ~ 1.25 kg/cm<sup>2</sup>, 13.51 ~ 17.77 psi)

\*\*\*\*\*

YB351003

**ASSEMBLY**

1. Install:
  - Protector
  - Fan motor assembly
  - Radiator assembly

	<b>Bolt (protector):</b> 5 Nm (0.5 m•kg, 3.6 ft•lb) <b>Bolt (radiator):</b> 10 Nm (1.0 m•kg, 7.2 ft•lb)
---	--

2. Connect:
  - Radiator hose (to water pump)
  - Radiator hose (from conduction)
  - Fan motor coupler
3. Tighten:
  - Drain bolts

	<b>Drain bolt:</b> 10 Nm (1.0 m•kg, 7.2 ft•lb)
---	---

**NOTE:** \_\_\_\_\_  
 Replace with new copper gaskets.

---

4. Install:
  - Engine guard

	<b>Nut (engine guard):</b> 7 Nm (0.7 m•kg, 5.1 ft•lb) <b>Bolt (engine guard):</b> 7 Nm (0.7 m•kg, 5.1 ft•lb)
---	---



# RADIATOR

COOL

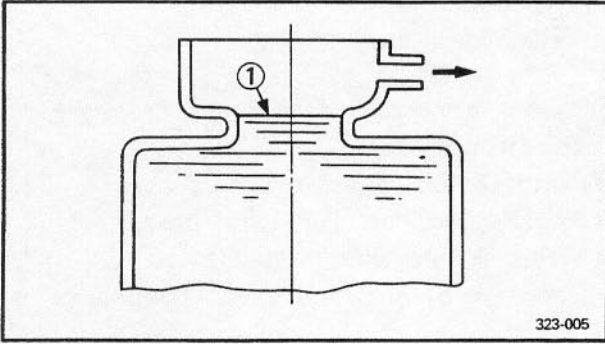

## 5. Fill:

- Cooling system

\*\*\*\*\*

### Coolant filling steps:

- Fill the coolant into the radiator until the radiator is full.
- Start the engine (coolant level decreases).

### CAUTION:

**Always check coolant level, and check for coolant leakage before starting engine.**

- Add the coolant while engine is running.
- Stop the engine when coolant level stabilizes.
- Add the coolant again to specified level ①.
- Install the radiator cap.

\*\*\*\*\*

### Recommended coolant:

**High quality ethylene glycol anti-freeze containing anti-corrosion for aluminum engine inhibitors**



**Coolant and water mixed ratio:  
50%:50%**

**Total amount:**

**1.2 L (1.1 Imp qt, 1.3 US qt)**

**Recovery tank capacity:**

**0.29 L (0.26 Imp qt, 0.31 US qt)**

**From "LOW" to "FULL" level:**

**0.17 L (0.15 Imp qt, 0.18 US qt)**

### CAUTION:

- Hard water or salt water is harmful to the engine. You may use distilled water if you can not get soft water.
- Do not mix more than one type of ethylene glycol anti-freeze containing corrosion for aluminum engine inhibitors.

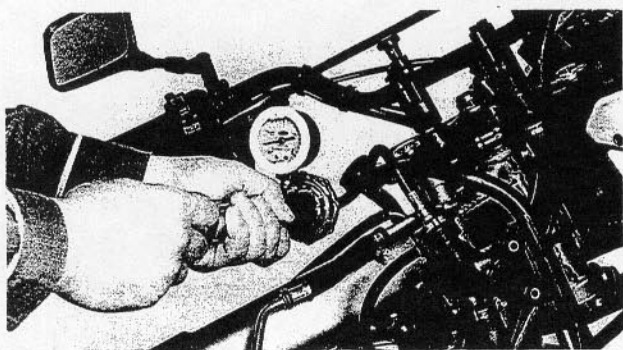

6. Inspect:
- Cooling system

\*\*\*\*\*

**Inspection steps:**

- Connect radiator cap tester.
  - Apply 1.0 kg/cm<sup>2</sup> (14 lb/in<sup>2</sup>) pressure.
  - Measure pressure with gauge.
- Decrease of pressure (leaks)→Repair as required.



**Radiator cap tester:**  
 P/N. YU-24460-1, 90890-01325  
**Adapter:**  
 P/N. YU-33984, 90890-01352

\*\*\*\*\*

YB252001

**WATER PUMP  
 DISASSEMBLY**

1. Remove:
- Seat
  - Side covers
  - Air scoops
  - Fuel tank
  - Engine guard

Refer to the "COOLANT REPLACEMENT" section in the CHAPTER 3.

**NOTE:** \_\_\_\_\_

Be sure to drain the coolant before disassembly of the cooling system components.

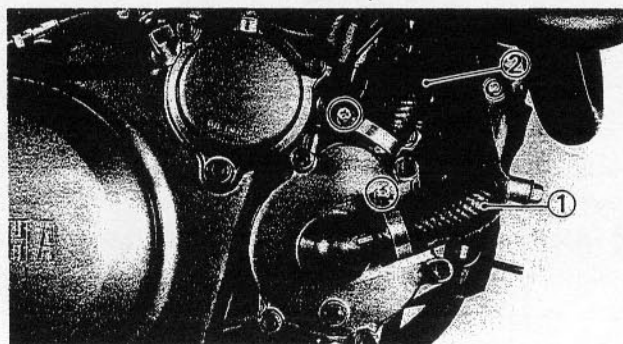

2. Disconnect:
- Radiator hose ① (from radiator)
  - Radiator hose ② (to cylinder)

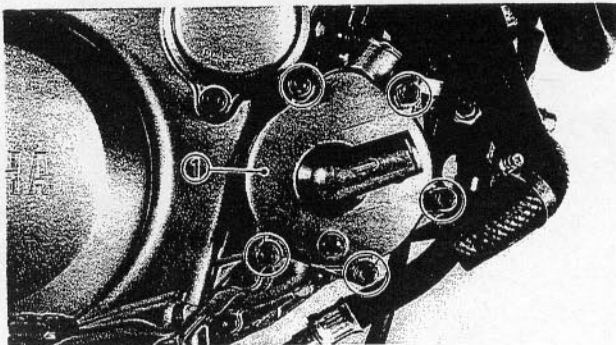

3. Remove:
  - Cover (water pump) ①

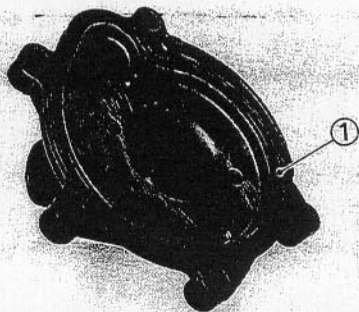

4. Remove:
  - O-ring ①

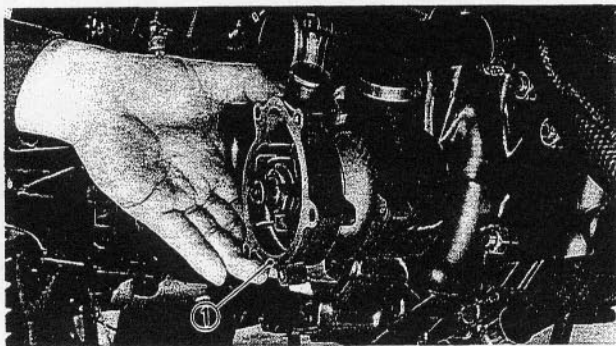

5. Remove:
  - Water pump housing ①

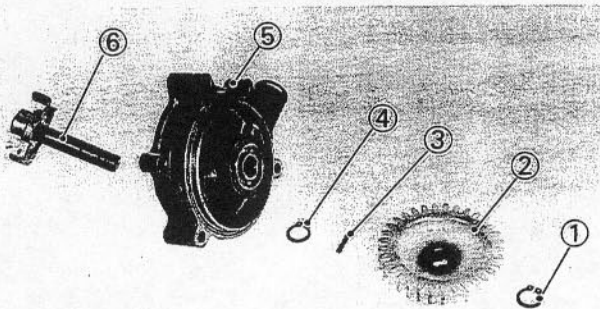

6. Remove:
  - Circlip ①
  - Water pump gear ②
  - Pin ③
  - Circlip ④
  - Water pump housing ⑤
  - Impeller ⑥

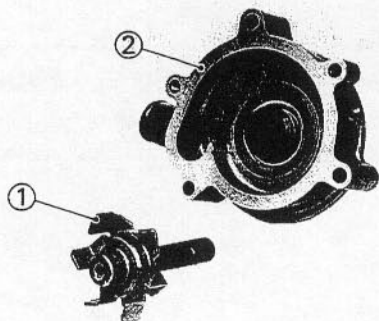

7. Eliminate:
  - Deposits
  - From the impeller ① and water pump housing ②.



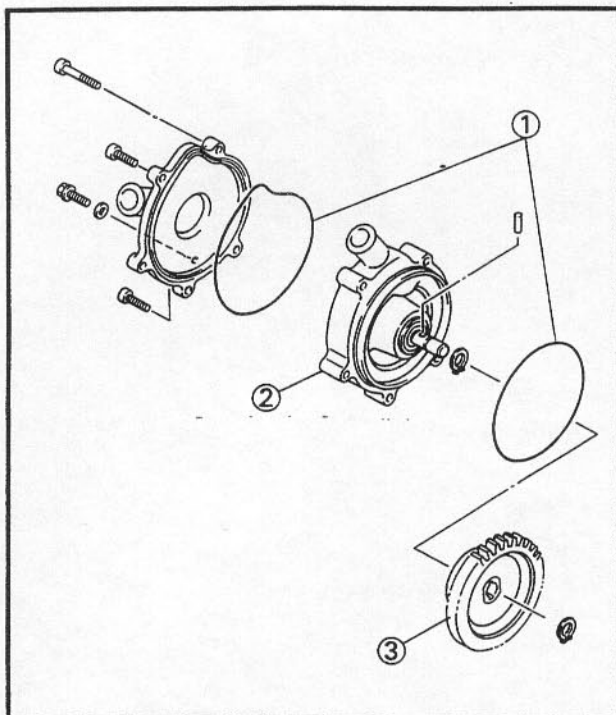

YB252002

**INSPECTION**

## 1. Inspect:

- O-ring ①
- Water pump housing ②
- Water pump gear ③

Cracks/Wear/Damage → Replace.

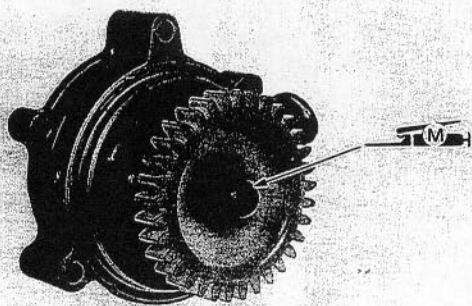

YB252003

**ASSEMBLY**

Reverse the "DISASSEMBLY" procedure.

## 1. Apply:

- Molybdenum disulfide grease  
(onto impeller shaft end).

## 2. Fill:

- Cooling system  
Refer to the "COOLANT REPLACEMENT"  
section in the CHAPTER 3.

YB253001

**THERMOSTAT****REMOVAL**

## 1. Remove:

- Seat
- Side covers
- Air scoops
- Fuel tank
- Engine guard

Refer to the "COOLANT REPLACEMENT"  
section in the CHAPTER 3.**NOTE:** \_\_\_\_\_Be sure to drain the coolant before disassembly  
of the cooling system components.  
\_\_\_\_\_

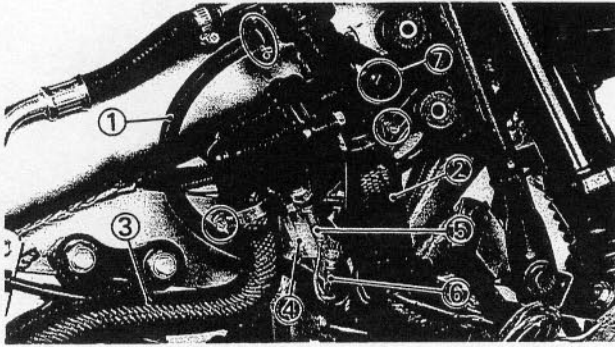

2. Disconnect:
  - Recovery tank hose ①
  - Radiator hose ② (from radiator)
  - Radiator hose ③ (to cylinder head)
  - Thermo switch lead ④
  - Thermo unit lead ⑤
  - Earth lead ⑥

3. Remove:
  - Bolt (conduction) ⑦

4. Remove:
  - Radiator cap ①
  - Conduction ②
  - O-ring ③
  - Thermostat ④
  - Thermostat housing ⑤

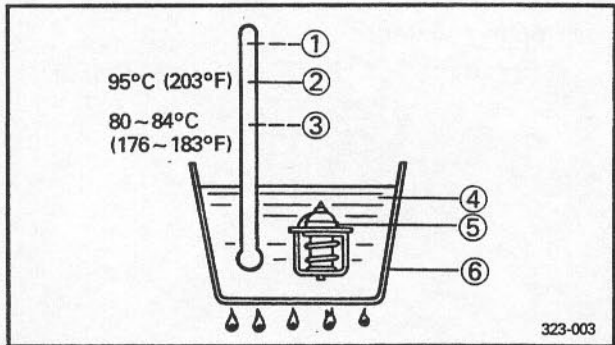
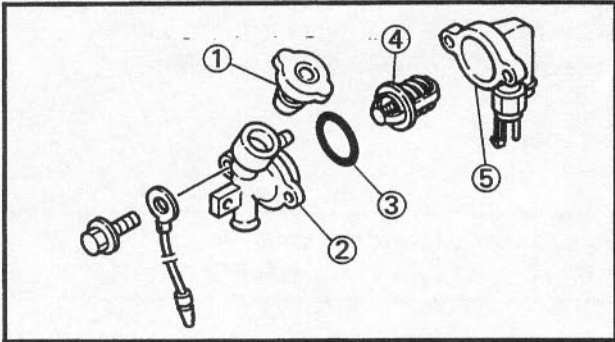

YB253002

**INSPECTION**

1. Inspect:
  - Thermostat ⑤
 Valve does not open at 80~84°C (176~183°F) → Replace.

\*\*\*\*\*

**Inspection steps:**

- Suspend thermostat in a vessel.
- Place reliable thermometer in a water.
- Heat water slowly.
- Observe thermometer, while stirring water continually.

\*\*\*\*\*

- ① Thermometer
- ② Full open
- ③ Opening sequence begins
- ④ Water
- ⑤ Thermostat
- ⑥ Vessel
- Ⓐ OPEN
- Ⓑ CLOSE

**NOTE:** \_\_\_\_\_

Thermostat is sealed and its setting is specialized work. If its accuracy is in doubt, replace it. A faulty unit could cause serious overheating or overcooling.

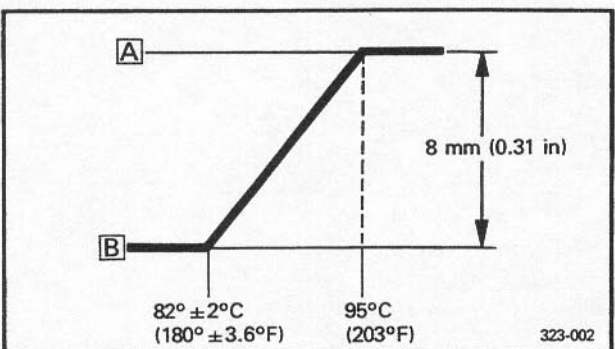



## 2. Inspect:

- O-ring

Wear/Damage → Replace.

YB253003

**ASSEMBLY**

Reverse the "REMOVAL" procedure.

## 1. Install:

- Thermostat
- Conduction

**Bolt (conduction):****10 Nm (1.0 m•kg, 7.2 ft•lb)**

## 2. Fill:

- Cooling system

Refer to the "COOLANT REPLACEMENT" section in the CHAPTER 3.



## CHAPTER 6. CARBURETION

<b>CARBURETOR</b> .....	I-5
SECTIONAL VIEW .....	I-5
REMOVAL .....	I-6
DISASSEMBLY .....	I-6
INSPECTION .....	I-8
ASSEMBLY .....	I-9
INSTALLATION .....	I-12
FUEL LEVEL ADJUSTMENT .....	I-12
<b>FUEL PUMP</b> .....	I-13
PUMP OPERATION INSPECTION .....	I-13
REMOVAL .....	I-13
INSPECTION .....	I-14
ASSEMBLY .....	I-14



CARBURETION

CARBURETOR

- ① Connecting arm
- ② Jet needle set
- ③ Throttle valve
- ④ Coasting enricher
- ⑤ Valve seat assembly
- ⑥ Needle jet
- ⑦ O-ring
- ⑧ Main jet
- ⑨ Pilot jet
- ⑩ Pilot screw set
- ⑪ Throttle stop screw
- ⑫ Float
- ⑬ Starter plunger set
- ⑭ Drain screw
- ⑮ Main jet
- ⑯ Needle jet
- ⑰ Piston valve
- ⑱ Jet needle set

SPECIFICATIONS		
ID MARK	3YF-00, 4BW00 (A) (CH)	
	PRIMARY	SECONDARY
MAIN JET (M.J.)	# 130	# 165
PILOT JET (P.J.)	# 48	—
JET NEEDLE (J.N.)	5D96-3/5 5D97-3/5 (A) (CH)	5X7C-3/5
NEEDLE JET (N.J.)	V00	φ2.7
PILOT SCREW (P.S.)	2 and 1/2 turns out	—
FLOAT HEIGHT (F.H.)	25 ~ 27 mm (0.98 ~ 1.06 in)	
FUEL LEVEL <span style="border: 1px solid black; padding: 0 2px;">A</span> (F.L.)	6.0 ~ 8.0 mm (0.24 ~ 0.31 in) Below from the float chamber mating surface	
ENGINE IDLING SPEED	1,250 ~ 1,350 r/min	

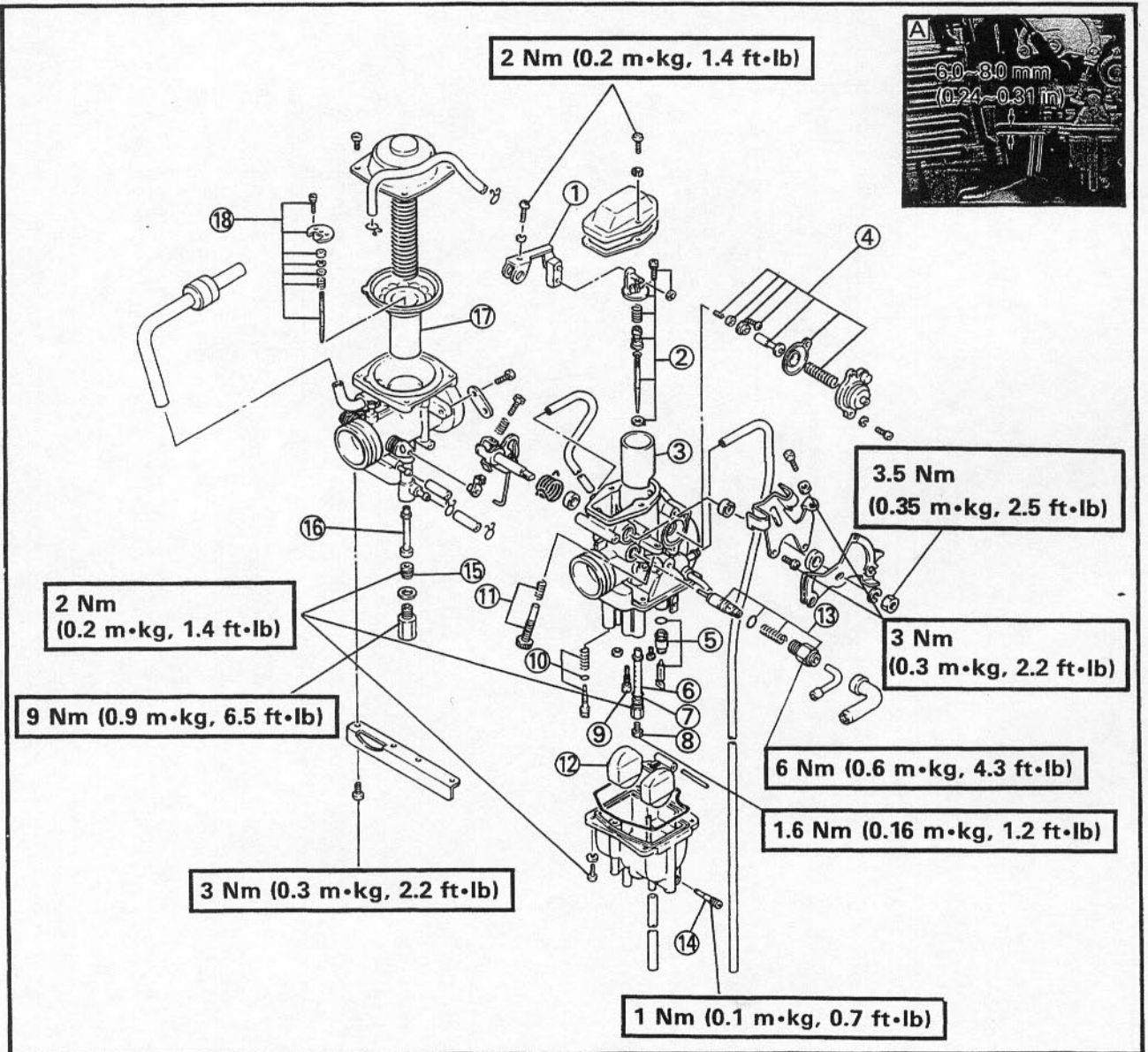



**SECTIONAL VIEW**

- ① Jet needle (primary)
- ② Valve seat
- ③ Needle valve
- ④ Needle jet (primary)
- ⑤ Main jet (primary)
- ⑥ Pilot screw
- ⑦ Jet needle (secondary)
- ⑧ Needle jet (secondary)
- ⑨ Main jet (secondary)

- A** Primary carburetor
- B** Secondary carburetor

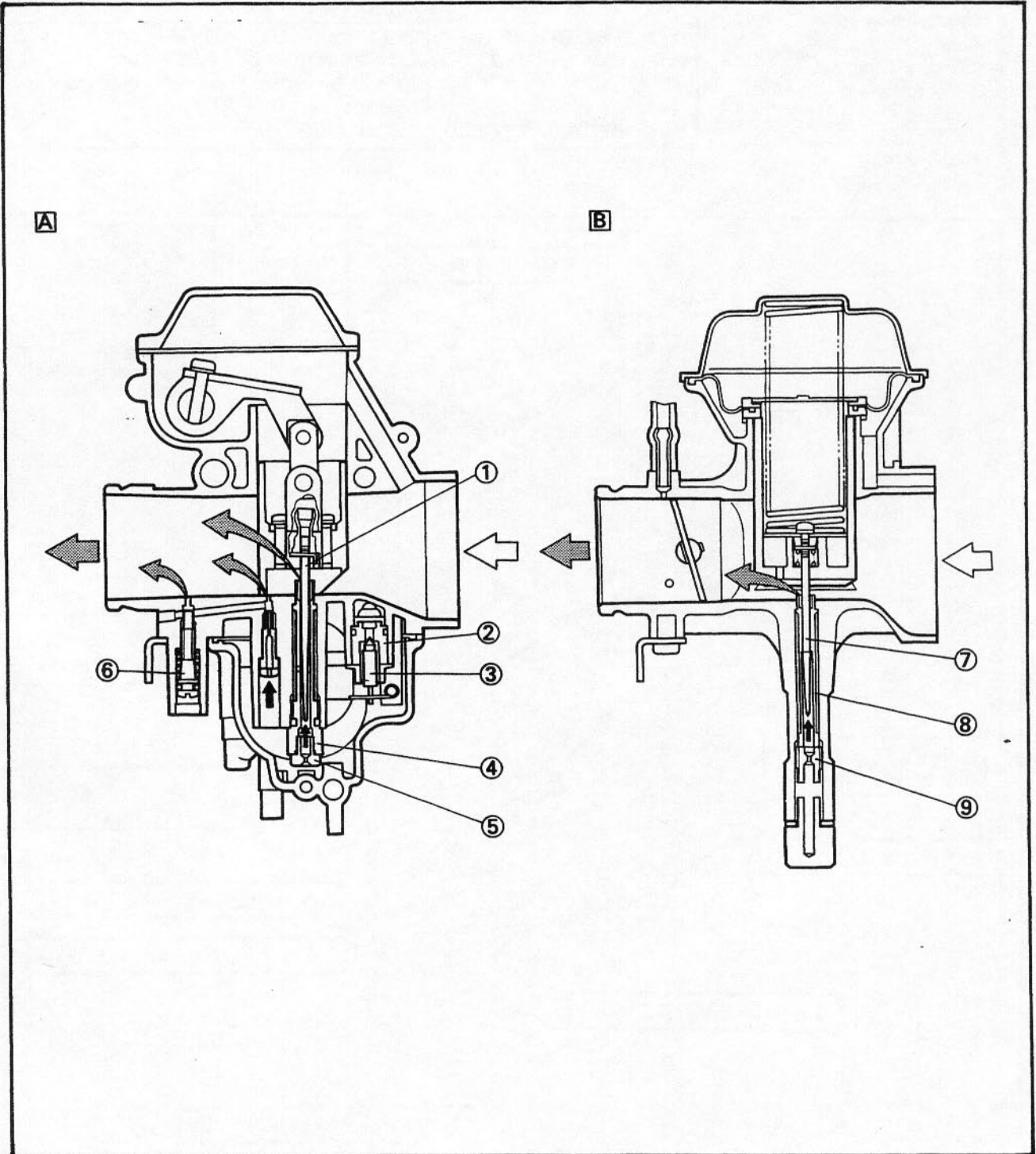
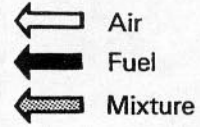





## REMOVAL

### 1. Remove:

- Seat
- Side covers
- Air scoops
- Fuel tank

Refer to the "SEAT, FUEL TANK AND COVER" section in the CHAPTER 3.

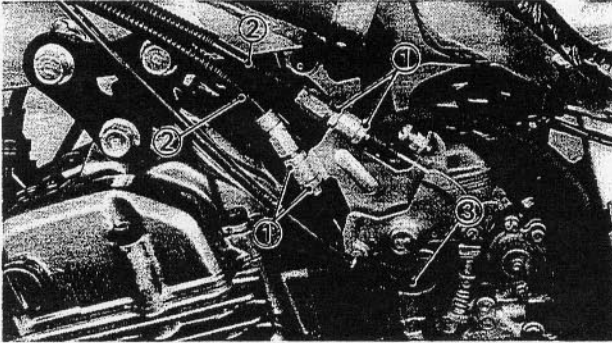

### 2. Loosen:

- Locknut ①

### 3. Remove:

- Throttle cables ②
- Starter plunger ③

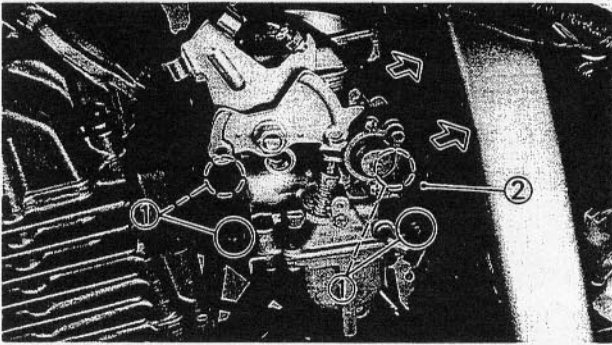

### 4. Loosen:

- Screws (carburetor joints) ①

**NOTE:** \_\_\_\_\_

Move carburetor joint bands ② to the rear.

\_\_\_\_\_

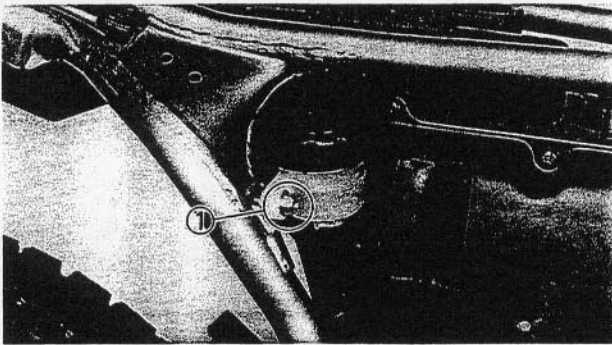

### 5. Remove:

- Bolt ① (rear brake reservoir tank)

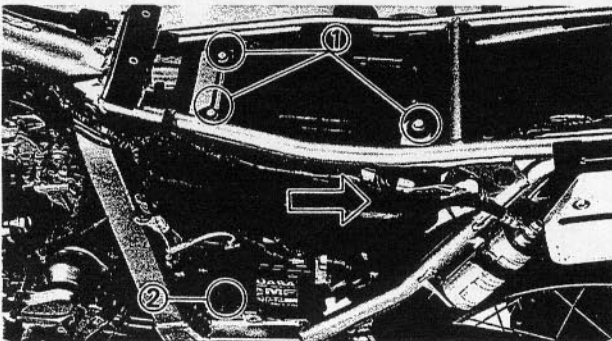

### 6. Remove:

- Bolts ① (air filter case)

### 7. Loosen:

- Bolt ② (air filter case)
- Carburetor joint from carburetor by moving air filter case to the rear.

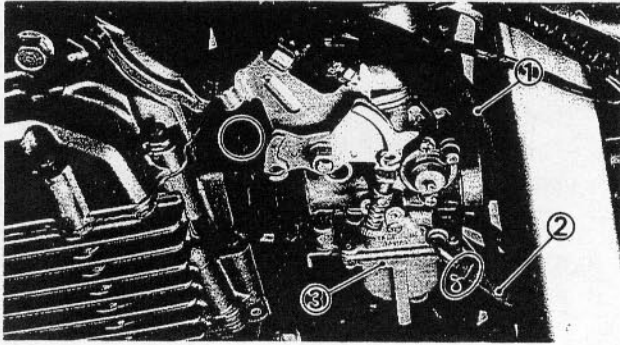

### 8. Disconnect:

- Vacuum hose ①
- Delivery hose ②
- Carburetor assembly ③  
(from intake manifold)

## DISASSEMBLY

### NOTE:

The following parts can be cleaned and inspected without disassembly.

- Diaphragm (coasting enricher)
- Starter plunger
- Throttle stop screw

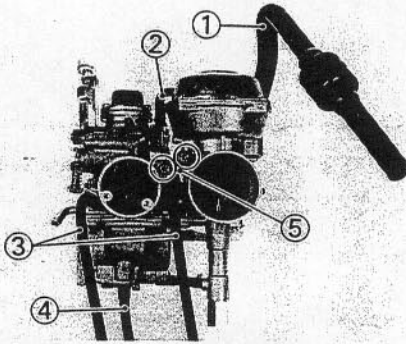

### 1. Disconnect:

- Air vent hose ①
- Vacuum hose ②
- Air vent pipe ③
- Over flow hose ④

### 2. Remove:

- Stay plate ⑤ (rear)
- Stay plate ⑥ (front)

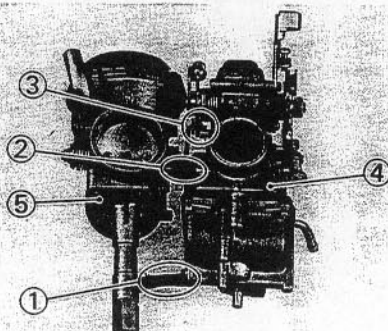
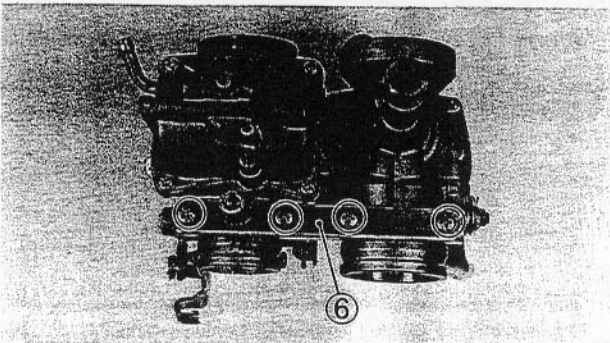

### 3. Disconnect:

- Pipe ①
- Pipe ②
- Link rod ③

### 4. Separate:

- Primary carburetor ④
- Secondary carburetor ⑤



## Primary carburetor

### 1. Remove:

- Float chamber ①
- Float pin ②
- Float ③

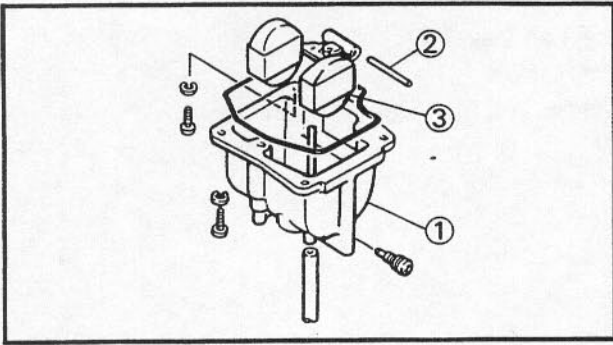

### NOTE:

Remove the float pin in the arrow direction.

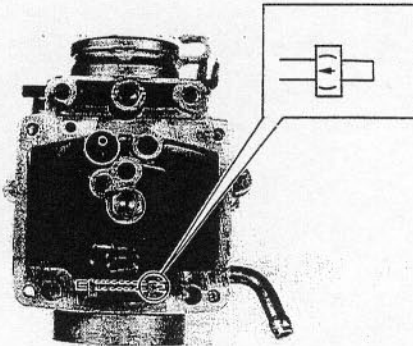

### 2. Remove:

- Needle valve/Valve seat ①
- Main jet/Needle jet ②
- Pilot jet ③
- Pilot screw ④
- O-ring ⑤

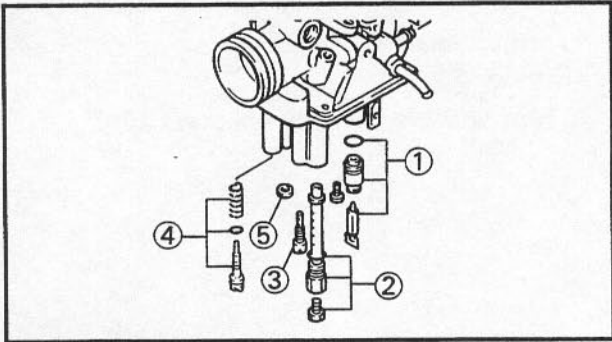

### 3. Disconnect:

- Throttle stop screw ①

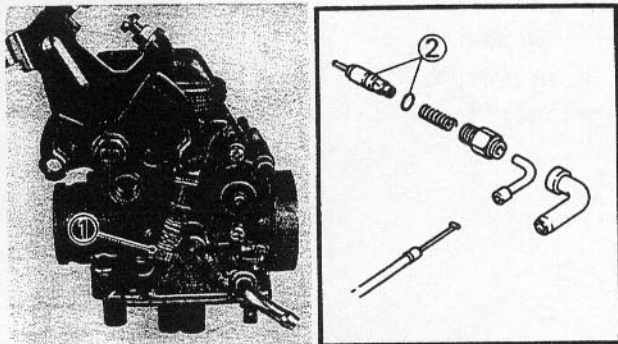

### 4. Remove:

- Starter plunger ②  
(from the starter cable)

### 5. Remove:

- Cover ① (coasting enricher)
- Spring ②
- Diaphragm ③

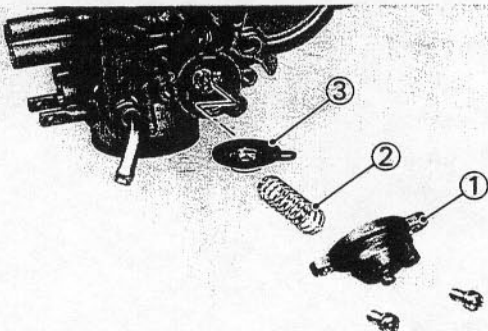



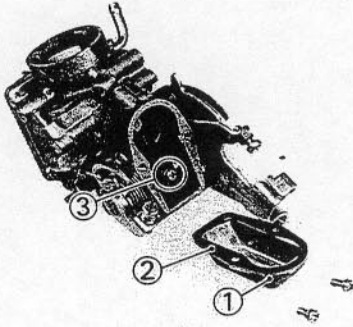

6. Remove:
- Top cover ①
  - Gasket ②
  - Screw ③ (connecting arm)

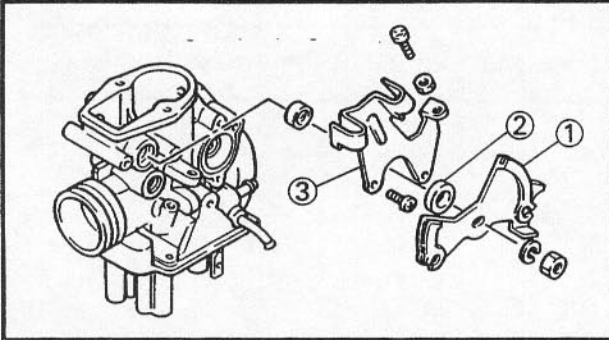

7. Remove:
- Throttle lever ①
  - Collar ②
  - Cable holder ③

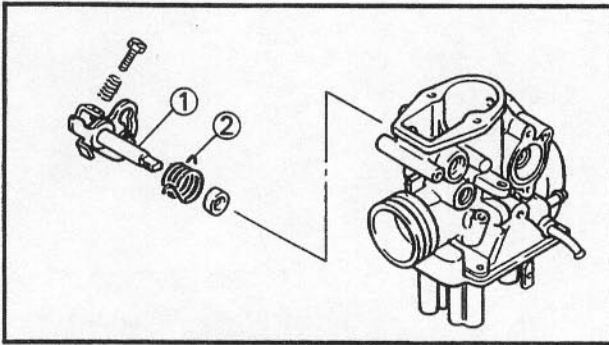

8. Remove:
- Throttle shaft ①
  - Spring ②
  - Throttle valve (with connecting arm)

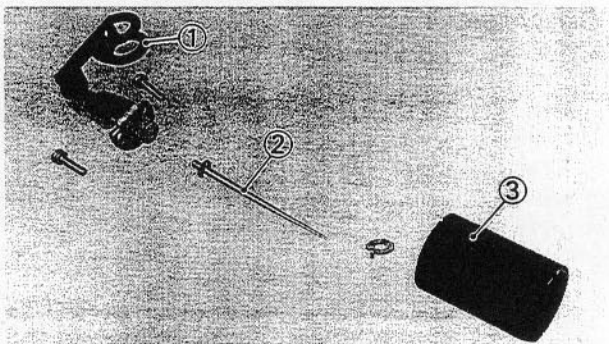

9. Remove:
- Connecting arm ①
  - Jet needle ②
  - Throttle valve ③

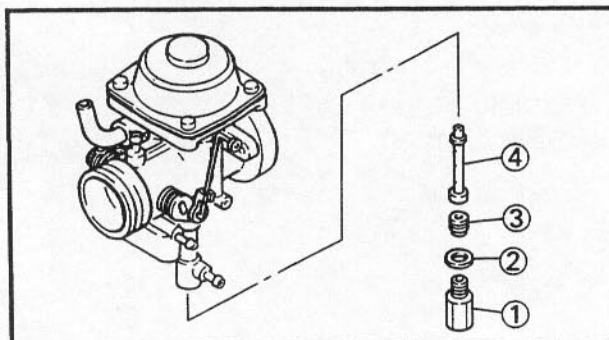

### Secondary carburetor

1. Remove:
- Plug ①
  - Gasket ②
  - Main jet ③
  - Needle jet ④

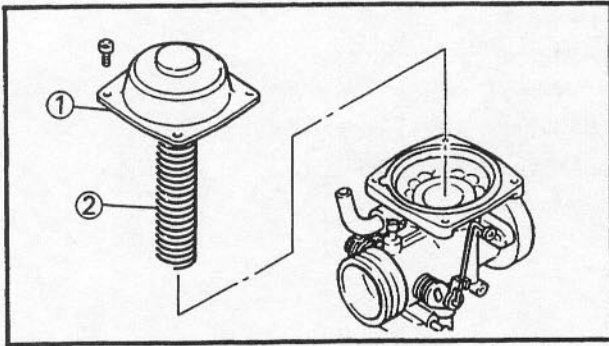

2. Remove:
- Top cover ①
  - Spring ②

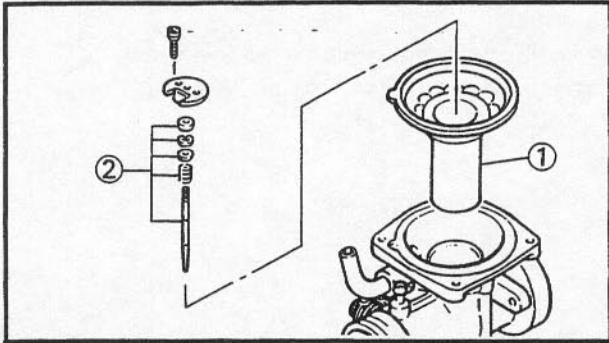

3. Remove:
- Piston valve ①
  - Jet needle ②

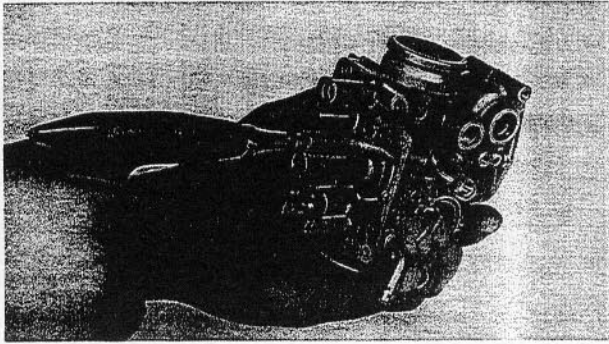

## INSPECTION

1. Inspect:
- Carburetor body
  - Float chamber
  - Cracks/Damage → Replace.
  - Fuel passage
  - Contamination → Clean.

## NOTE:

Use a petroleum based solvent for cleaning. (Do not use any caustic carburetor cleaning solution.)  
Blow out all passages and jets with compressed air.

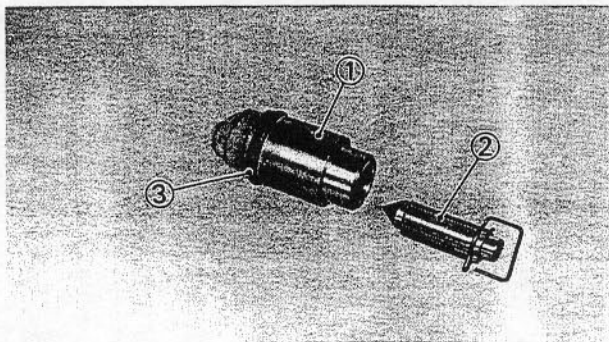

2. Inspect:
- Valve seat ①
  - Needle valve ②
  - O-ring ③
  - Damage/Wear/Contamination → Replace as a set.

## NOTE:

Always replace the needle valve and valve seat as a set.

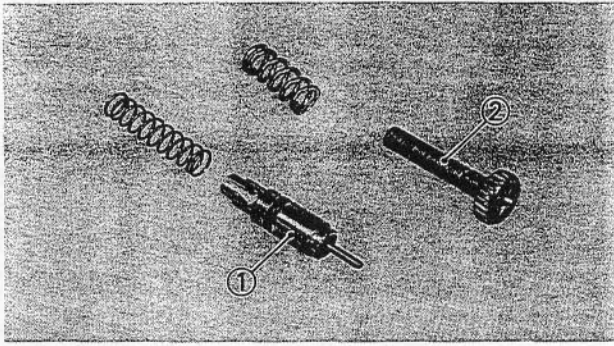

### 3. Inspect:

- Starter plunger ①  
Wear/Damage → Replace.
- Throttle stop screw ②  
Damage → Replace.

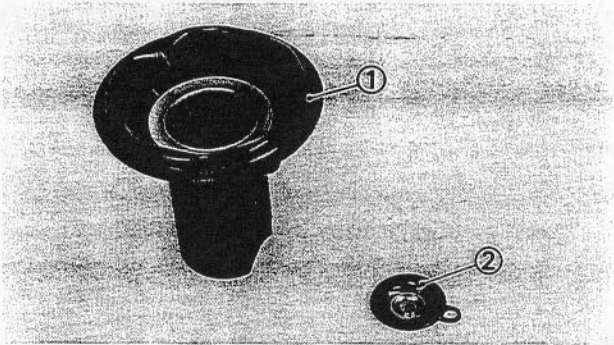

### 4. Inspect:

- Rubber diaphragm ① (piston valve)
  - Rubber diaphragm ② (coasting enricher)
- Tears/Damage → Replace.

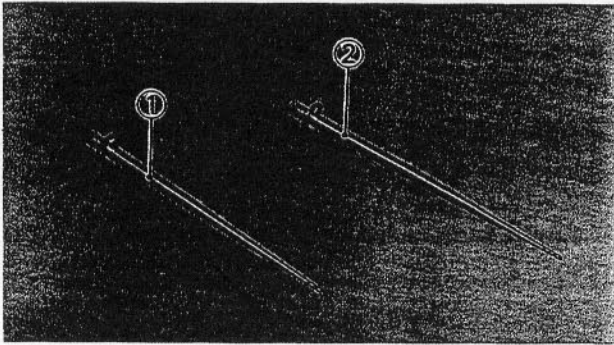

### 5. Inspect:

- Jet needle ① (primary)
  - Jet needle ② (secondary)
- Bends/Wear/Damage → Replace.

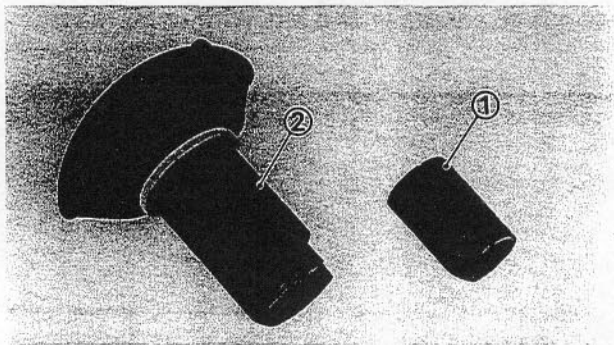

### 6. Inspect:

- Throttle valve ① (primary)
  - Piston valve ② (secondary)
- Scratches/Wear/Damage → Replace.

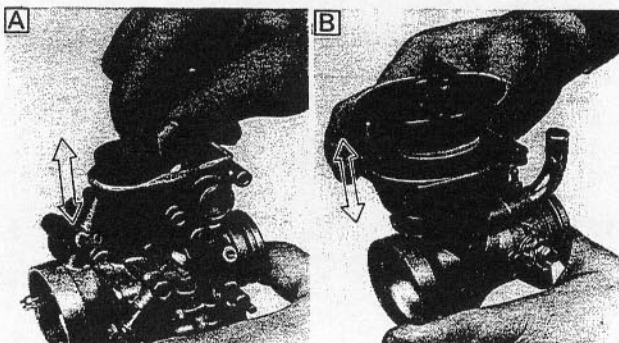

### 7. Check:

- Free movement
- Stick → Replace.
- Insert the throttle valve and piston valve into the carburetor body, and check for free movement.

- A** Primary carburetor
- B** Secondary carburetor



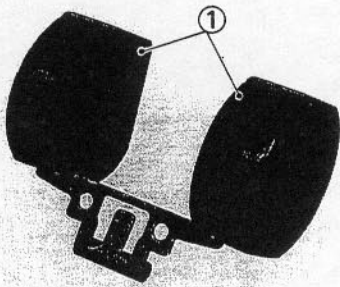

8. Inspect:
- Float ①
- Damage → Replace.

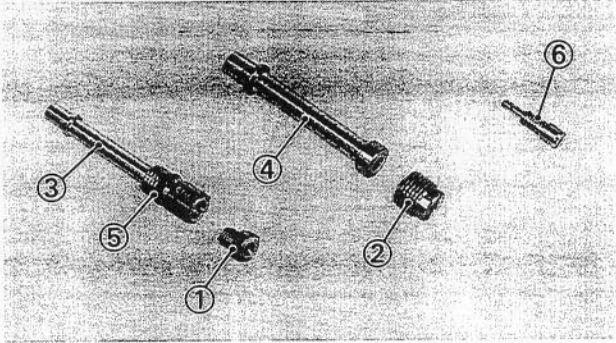

9. Inspect:
- Main jet ① (primary)
  - Main jet ② (secondary)
  - Needle jet ③ (primary)
  - Needle jet ④ (secondary)
  - O-ring ⑤ (primary)
  - Pilot jet ⑥
- Wear/Damage → Replace.  
Contamination → Blow out jets with compressed air.

### ASSEMBLY

Reverse the "DISASSEMBLY" procedures. Note the following points.

### CAUTION:

- Before reassembling, wash the all parts in clean petroleum based solvent.
- Always use a new gasket.

### Secondary carburetor

1. Install:
- Jet needle ①
  - Piston valve ②

NOTE: \_\_\_\_\_

Match the tab on the rubber diaphragm to the matching recess in the secondary carburetor.

2. Install:
- Spring ①
  - Top cover ②

**Screw (top cover):**  
2 Nm (0.2 m•kg, 1.4 ft•lb)

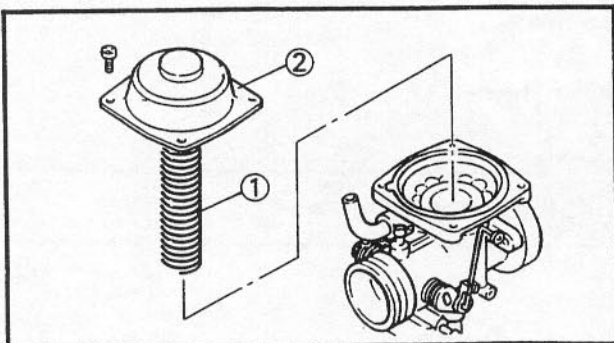
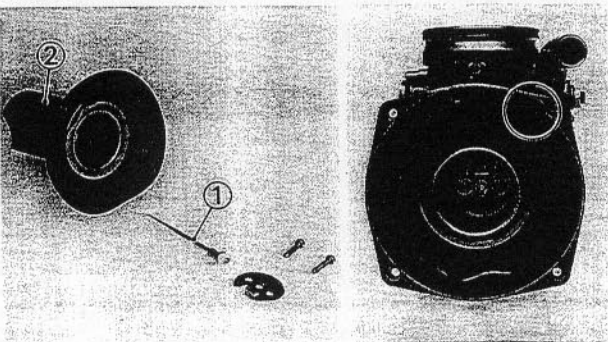

# CARBURETOR

# CARB

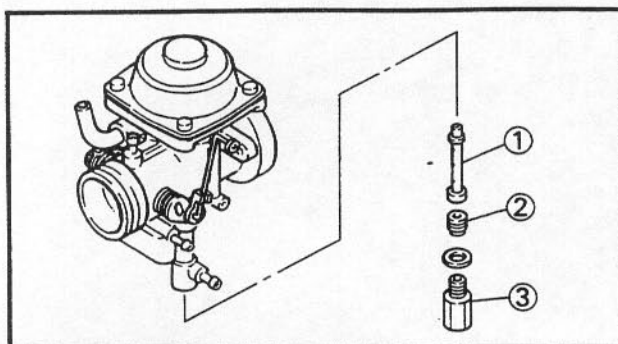

### 3. Install:

- Needle jet ①
- Main jet ②
- Plug ③



#### Main jet:

2 Nm (0.2 m•kg, 1.4 ft•lb)

#### Plug:

9 Nm (0.9 m•kg, 6.5 ft•lb)

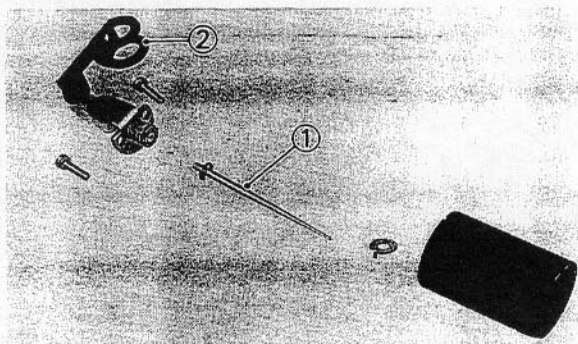

### Primary carburetor

#### 1. Install:

- Jet needle ①
- Connecting arm ②  
(to throttle valve)



#### Screw (connecting arm):

0.8 Nm (0.08 m•kg, 0.6 ft•lb)

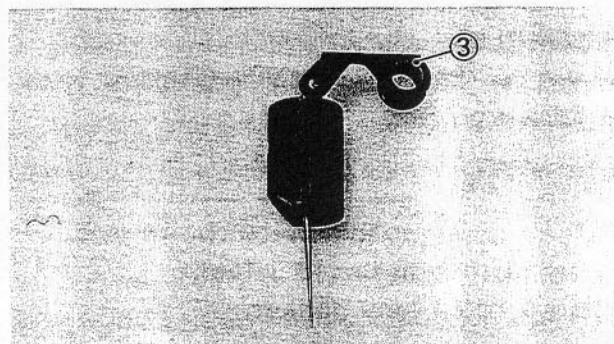

### NOTE:

Make sure that the connecting arm assembly ③ is at the illustrated position.

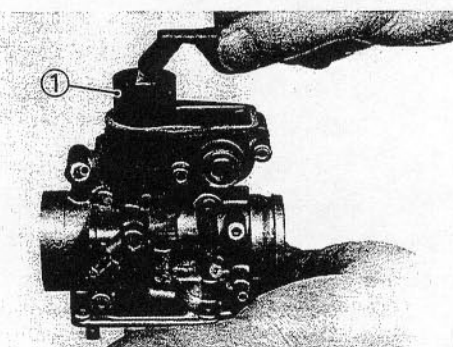

### 2. Install:

- Throttle valve ①

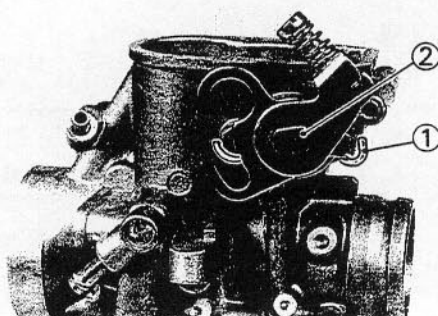

### 3. Install:

- Spring ①
- Throttle shaft ②

### NOTE:

Set the spring as shown.

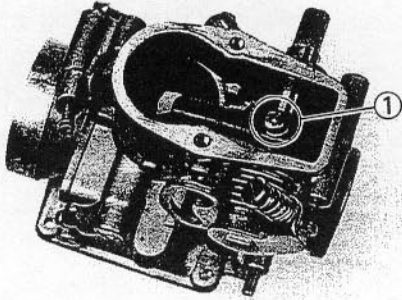

4. Install:

- Screw ① (connecting arm)

NOTE:

Turn the throttle shaft 1/2-turn clockwise to give preload to the spring and hold it. Then, install the screw (connecting arm).

	<p><b>Screw (connecting arm):</b> 2 Nm (0.2 m•kg, 1.4 ft•lb)</p>
--	--

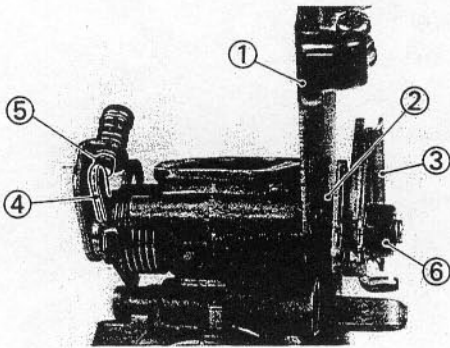

5. Install:

- Cable holder ①
- Collar ②
- Throttle lever ③

NOTE:

Be sure throttle shaft lever ④ and adjusting bolt ⑤ are aligned when tightening throttle shaft nut ⑥.

	<p><b>Screw (cable holder):</b> 3 Nm (0.3 m•kg, 2.2 ft•lb)</p>
	<p><b>Nut (throttle lever):</b> 3.5 Nm (0.35 m•kg, 2.5 ft•lb)</p>

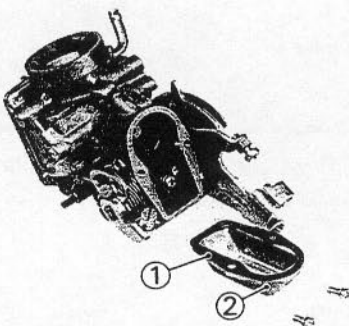

6. Install:

- Gasket ①
- Top cover ②

	<p><b>Screw (top cover):</b> 2 Nm (0.2 m•kg, 1.4 ft•lb)</p>
--	---



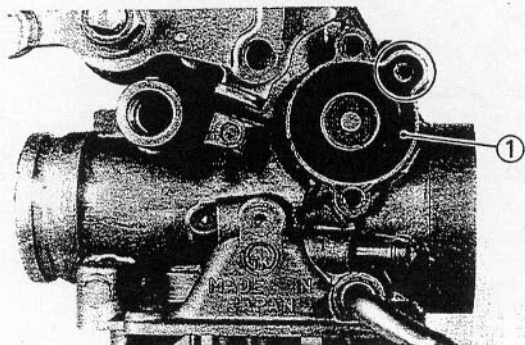

7. Install:

- Rubber diaphragm ① (coasting enricher)

**NOTE:** \_\_\_\_\_

Match the tab on the rubber diaphragm to the matching recess in the coasting enricher.

---

8. Connect:

- Starter plunger (to the starter cable)

9. Install:

- Throttle stop screw

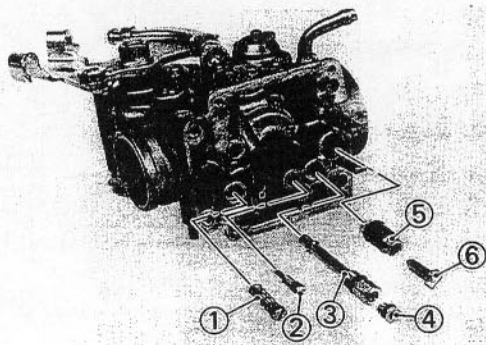

10. Install:

- Pilot screw ①
- Pilot jet ②
- Needle jet ③
- Main jet ④
- Valve seat ⑤
- Needle valve ⑥ (with float)

	<p><b>Needle jet:</b> 2 Nm (0.2 m•kg, 1.4 ft•lb)</p> <p><b>Main jet:</b> 1.6 Nm (0.16 m•kg, 1.2 ft•lb)</p> <p><b>Screw (valve seat):</b> 2 Nm (0.2 m•kg, 1.4 ft•lb)</p>
---	---

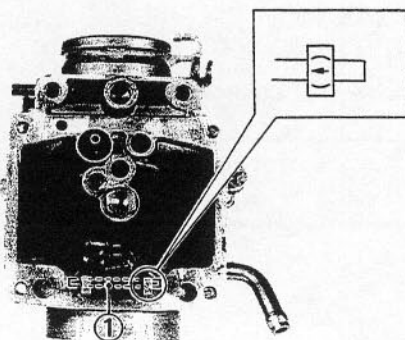

11. Install:

- Float pin ①

**NOTE:** \_\_\_\_\_

Install the float pin reverse to the arrow.

---

12. Measure:

- Float height (a)  
Out of specification → Adjust.

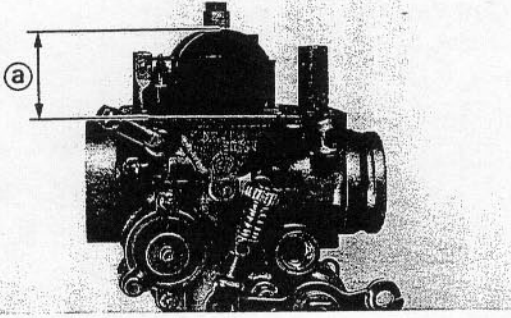

 **Float height (F.H.):**  
25.0 ~ 27.0 mm (0.98 ~ 1.06 in)

\*\*\*\*\*

**Measurement and adjustment steps:**

- Hold the carburetor in an upside down position.
- Measure the distance from the mating surface of the float chamber (gasket removed) to the top of the float.

**NOTE:** \_\_\_\_\_

The float arm should be resting on the needle valve, but not compressing the needle valve.

- If the float height is not within specification, inspect the valve seat and needle valve.
- If either is worn, replace them both.
- If both are fine, adjust the float height by bending the float tang (1) on the float.
- Recheck the float height.

\*\*\*\*\*

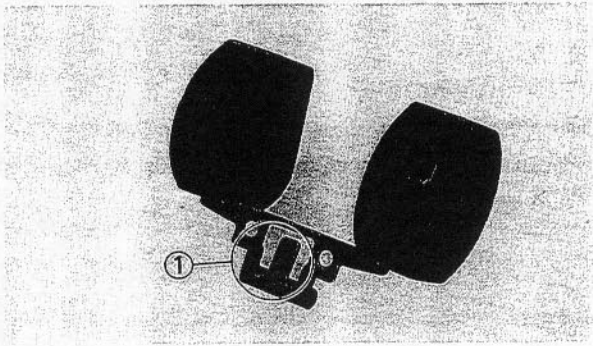

13. Install:

- Float chamber

 **Screw (float chamber):**  
2 Nm (0.2 m•kg, 1.4 ft•lb)

14. Adjust:

- Pilot screw (1)

\*\*\*\*\*

**Adjustment steps:**

- Turn in the pilot screw until it is lightly seated.
- Back out by the specified number of turns.

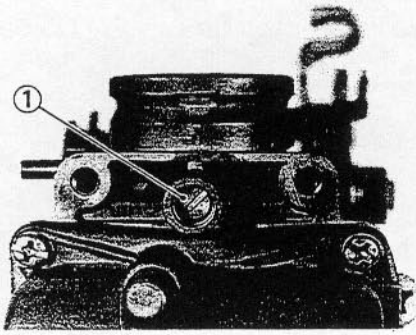

 **Pilot screw (turn out):**  
2 and 1/2 turns out

\*\*\*\*\*

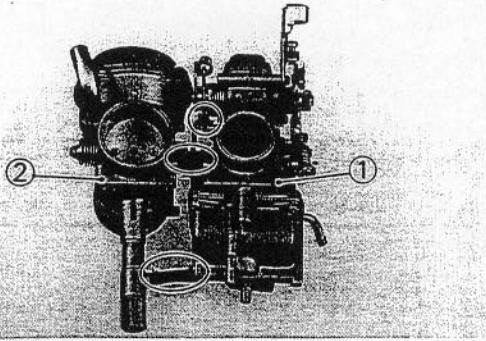

15. Install:

- Primary carburetor ①
- Secondary carburetor ②

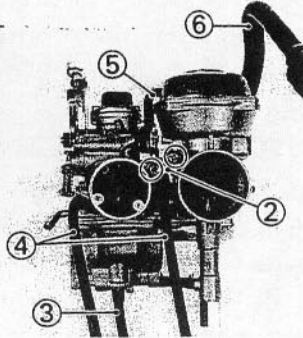
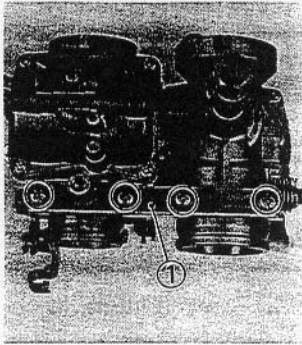

16. Install:

- Stay plate (front) ①
- Stay plate (rear) ②

	<b>Screw (stay plate):</b> 3 Nm (0.3 m·kg, 2.2 ft·lb)
--	--

**NOTE:** \_\_\_\_\_  
After tightening, check the throttle lever and throttle valve for smooth action.

17. Connect:

- Over flow hose ③
- Air vent pipe ④
- Vacuum hose ⑤
- Air vent hose ⑥

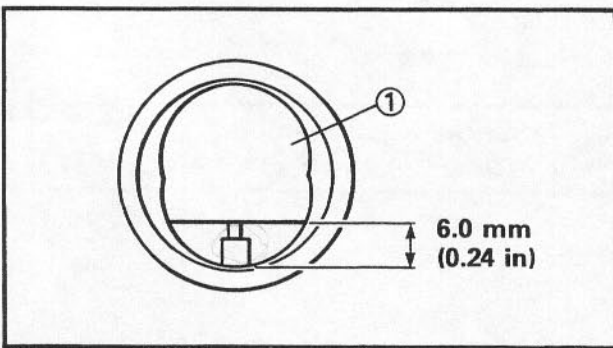

18. Adjust:

- Secondary carburetor synchronization

\*\*\*\*\*

**Adjustment steps:**

- Raise the primary throttle valve ① to a height of 6.0 mm (0.24 in) as indicated.
- Turn the synchronizing screw ① in or out so that secondary throttle valve ② is begun to open.

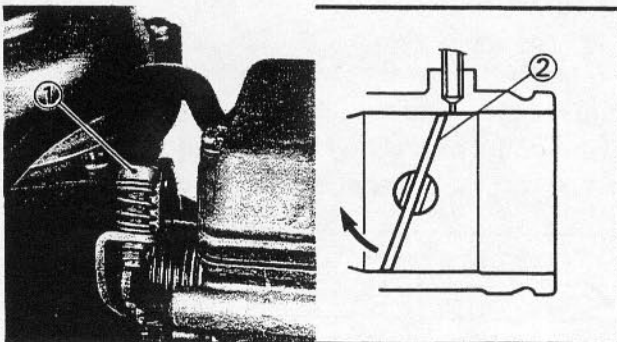



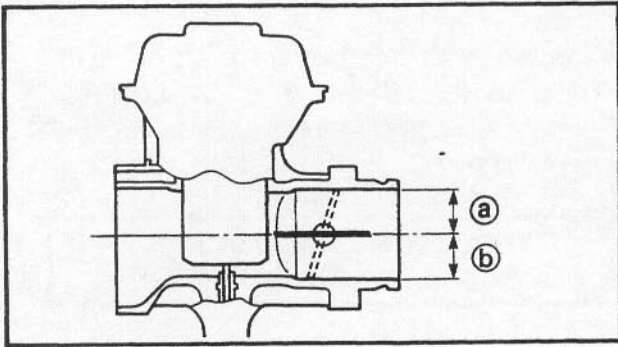

- Make sure that the secondary valve is opened horizontally (a = b) when the primary carburetor valve is fully opened.

\*\*\*\*\*

**INSTALLATION**

Reverse the "REMOVAL" procedures. Note the following points.

1. Install:

- Carburetor assembly

	<p><b>Screw (joint band-left)</b> 2 Nm (0.2 m•kg, 1.4 ft•lb)</p> <p><b>Screw (joint band-right):</b> 5 Nm (0.5 m•kg, 3.6 ft•lb)</p>
---	---

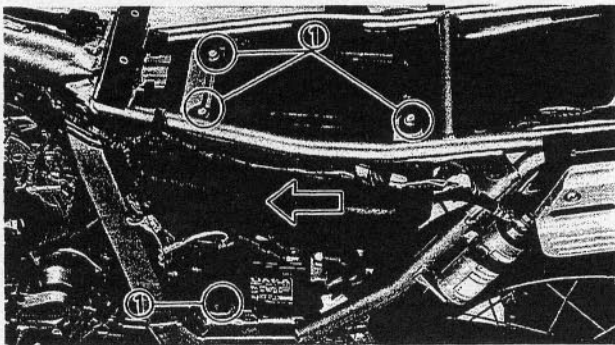

2. Install:

- Carburetor joint to carburetor by moving air filter case forward.
- Bolts (air filter case) ①

	<p><b>Bolt (air filter case):</b> 10 Nm (1.0 m•kg, 7.2 ft•lb)</p> <p><b>Screw (joint band-left):</b> 2 Nm (0.2 m•kg, 1.4 ft•lb)</p> <p><b>Screw (joint band-right):</b> 5 Nm (0.5 m•kg, 3.6 ft•lb)</p>
---	--

3. Install:

- Throttle cable ①
- Starter plunger ②

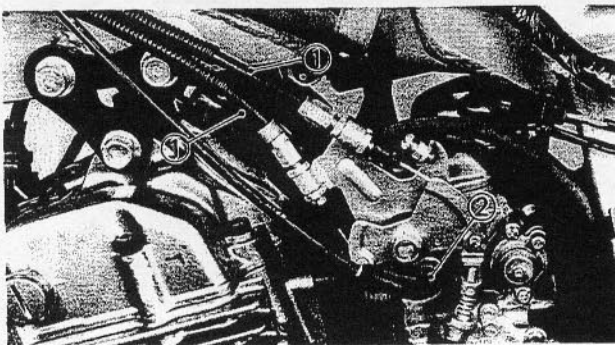

	<p><b>Starter plunger:</b> 6 Nm (0.6 m•kg, 4.3 ft•lb)</p>
---	---



4. Adjust:

- Throttle cable free play

Refer to the "THROTTLE CABLE FREE PLAY ADJUSTMENT" section in the CHAPTER 3.



**Throttle cable free play:**  
3~5 mm (0.12~0.20 in)

5. Adjust:

- Idle speed

Refer to the "IDLE SPEED ADJUSTMENT" section in the CHAPTER 3.



**Engine idle speed:**  
1,250 ~ 1,350 r/min

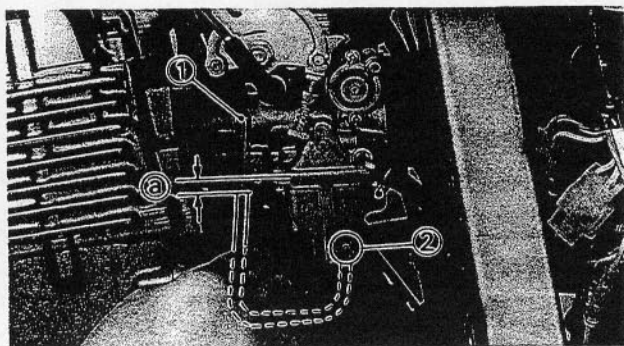

**FUEL LEVEL ADJUSTMENT**

1. Place the motorcycle on a level place.
2. Use the suitable stand under the frame and engine to ensure that the carburetor is positioned vertically.
3. Connect the Fuel Level Gauge ① to the float chamber drain pipe.



**Fuel level gauge:**  
P/N. YM-01312-A  
P/N. 90890-01312

4. Loosen the drain screw ②, and warm up the engine for several minutes.
5. Hold the gauge vertically next to the float chamber mating surface.
6. Measure:
  - Fuel level ③
 Out of specification → Adjust.



**Fuel level:**  
6.0~8.0 mm (0.24~0.31 in)  
Below from the float chamber mating surface

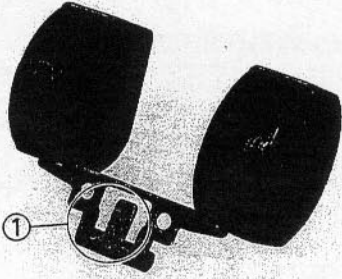

7. Adjust:
- Fuel level

\*\*\*\*\*

**Adjustment steps:**

- Remove the carburetor.
- Inspect the valve seat and needle valve.
- If either is worn, replace them both.
- If both are fine, adjust the float height by bending the float tang ① on the float.
- Recheck the fuel level.

\*\*\*\*\*



YB262001

### FUEL PUMP

#### PUMP OPERATION INSPECTION

1. Inspect:

- Fuel pump operation

\*\*\*\*\*

#### Operation inspection steps:

- Turn the fuel cock to "ON".
- Disconnect the delivery hose ① from the carburetor (fuel pump—carburetor).
- Place the receptacle under the delivery hose end.
- Turn the main switch to "ON".
- Push the starter switch.
- Check the fuel flow out from the delivery hose end.

If fuel does not flow out, replace the fuel pump assembly or refer to "INSPECTION" section.

\*\*\*\*\*

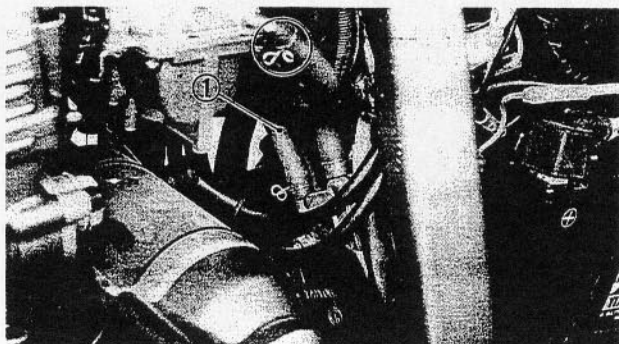

YB262002

### REMOVAL

1. Remove:

- Seat
- Side covers
- Air scoops
- Fuel tank

Refer to the "SEAT, FUEL TANK AND COVER" section in the CHAPTER 3.

2. Disconnect:

- Vacuum hose ① (from intake manifold)
- Delivery hose ② (from carburetor)

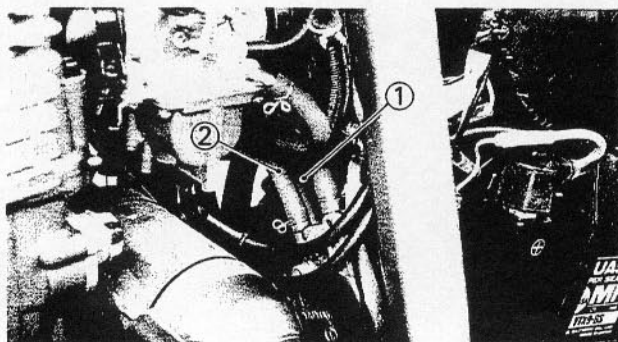

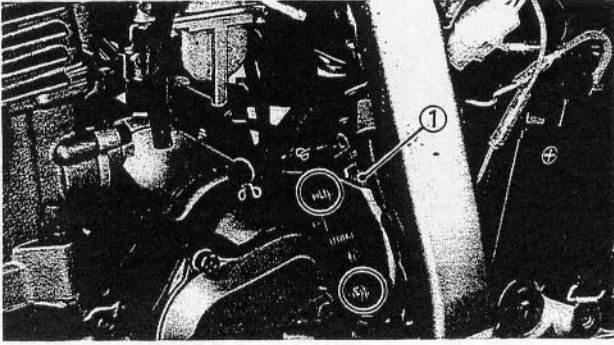

3. Remove:
- Fuel pump assembly ①

**INSPECTION**

1. Inspect:
- Fuel hose
  - Vacuum hose
  - Delivery hose
- Crack/Wear/Damage → Replace.

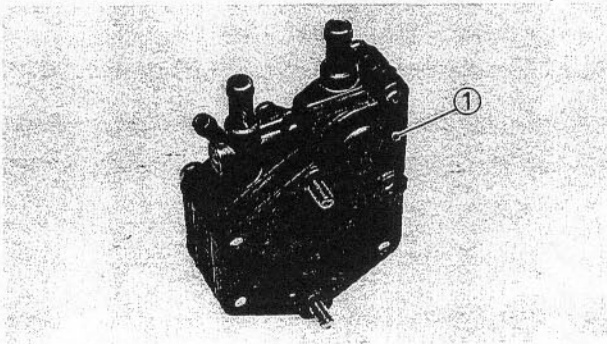

2. Inspect:
- Fuel pump assembly ①
- Crack/Damage → Replace.

YB262003

**ASSEMBLY**

Reverse the "REMOVAL" procedure. Note the following points.

1. Connect:
- Vacuum hose
  - Delivery hose
  - Fuel hose

**NOTE:** \_\_\_\_\_

Be sure to connect the hose correctly, when connecting.

\_\_\_\_\_

**2. Install:**

- Fuel tank
- Air scoops
- Side covers
- Seat



**Bolts (fuel tank, cowling and fuel tank, side cover):**

**7 Nm (0.7 m•kg, 5.1 ft•lb)**

**Bolt (seat):**

**10 Nm (1.0 m•kg, 7.2 ft•lb)**



## CHAPTER 7. CHASSIS

<b>FRONT WHEEL</b> .....	J-2
REMOVAL .....	J-2
INSPECTION .....	J-3
INSTALLATION .....	J-4
STATIC WHEEL BALANCE ADJUSTMENT .....	J-4
 <b>REAR WHEEL</b> .....	 J-5
REMOVAL .....	J-6
INSPECTION .....	J-6
INSTALLATION .....	J-7
STATIC WHEEL BALANCE ADJUSTMENT .....	J-7
 <b>FRONT AND REAR BRAKE</b> .....	 J-8
BRAKE PAD REPLACEMENT .....	J-9
CALIPER DISASSEMBLY .....	J-11
MASTER CYLINDER DISASSEMBLY .....	J-13
INSPECTION AND REPAIR .....	J-14
CALIPER ASSEMBLY .....	J-16
MASTER CYLINDER ASSEMBLY .....	K-3
 <b>FRONT FORK</b> .....	 K-6
REMOVAL .....	K-6
DISASSEMBLY .....	K-7
INSPECTION .....	K-8
ASSEMBLY .....	K-8
INSTALLATION .....	K-10
 <b>STEERING HEAD AND HANDLEBAR</b> .....	 K-11
REMOVAL .....	K-12
INSPECTION .....	K-13
INSTALLATION .....	K-14
 <b>REAR SHOCK ABSORBER AND SWINGARM</b> .....	 K-16
HANDLING NOTES .....	L-2
NOTES ON DISPOSAL .....	L-2
REMOVAL .....	L-2
INSPECTION .....	L-4
SIDE CLEARANCE ADJUSTMENT .....	L-5
INSTALLATION .....	L-6
 <b>DRIVE CHAIN AND SPROCKETS</b> .....	 L-8
REMOVAL .....	L-8
INSPECTION .....	L-9
INSTALLATION .....	L-10

CHASSIS

FRONT WHEEL

- ① Wheel axle
- ② Collar
- ③ Dust cover
- ④ Oil seal
- ⑤ Bearing
- ⑥ Collar
- ⑦ Front wheel
- ⑧ Bearing
- ⑨ Gear unit (speedometer)
- ⑩ Damper rubber
- ⑪ Disc cover

TIRE AIR PRESSURE (COLD):		
Cold tire pressure	Front	Rear
Up to 90 kg (198 lb) load*	200 kPa (2.00 kg/cm <sup>2</sup> , 28 psi)	200 kPa (2.00 kg/cm <sup>2</sup> , 28 psi)
90 kg (198 lb) ~ Maximum load*	200 kPa (2.00 kg/cm <sup>2</sup> , 28 psi)	225 kPa (2.25 kg/cm <sup>2</sup> , 32 psi)

\*Load is the total weight of cargo, rider, passenger and accessories.

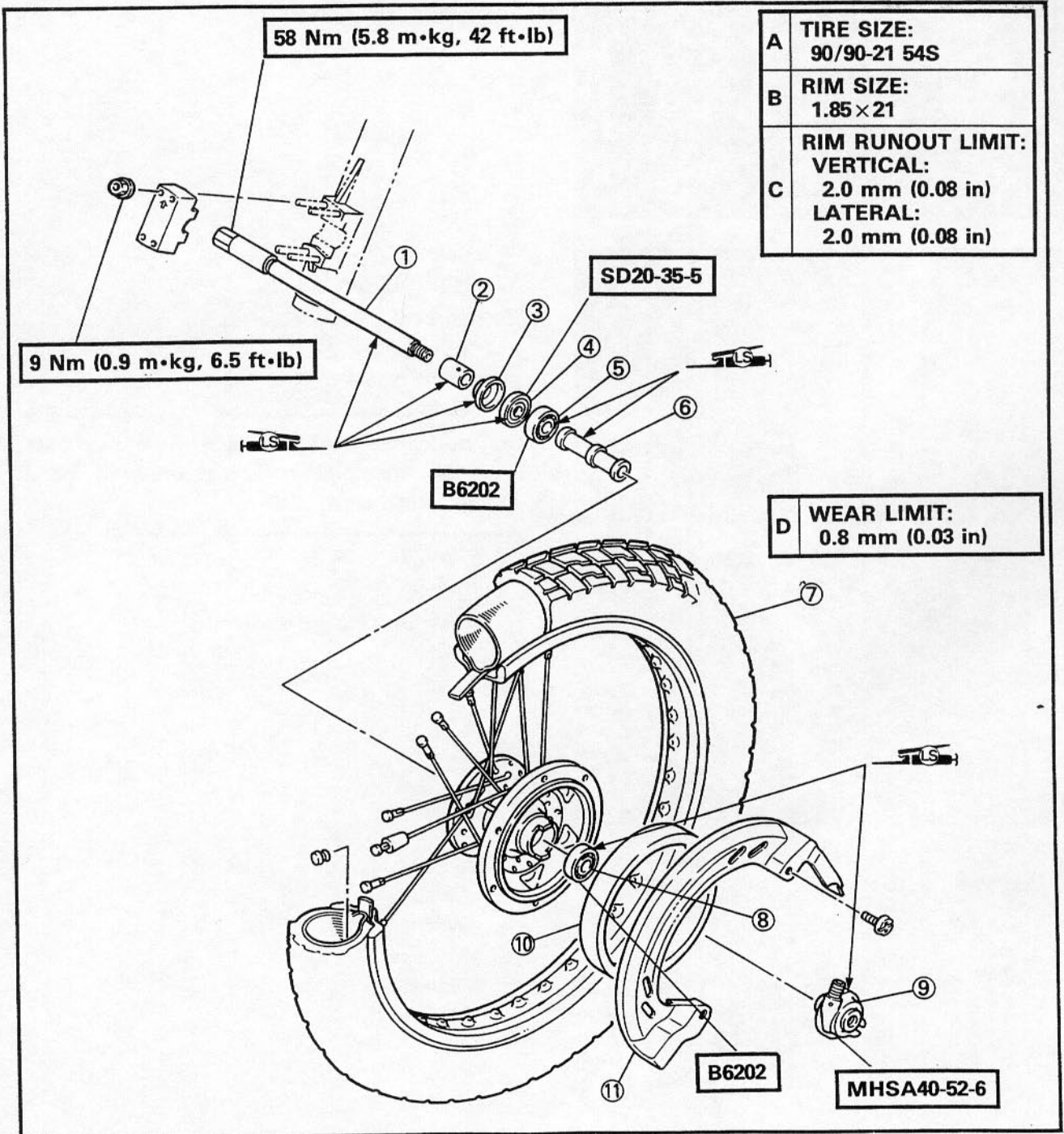



## REMOVAL

**WARNING**

Securely support the motorcycle so there is no danger of it falling over.

1. Place the motorcycle on a level place.
2. Elevate the front wheel by placing a suitable stand under the frame and engine.

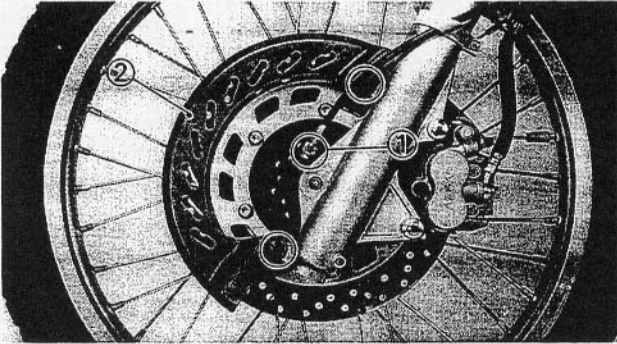

3. Remove:
  - Speedometer cable ①
  - Disc cover ②

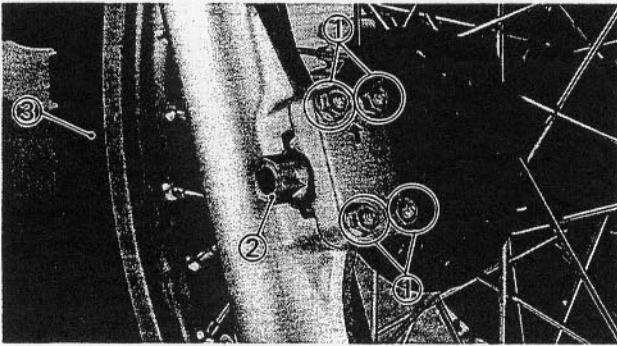

4. Loosen:
  - Nut ① (axle holder)
5. Remove:
  - Wheel axle ②
  - Front wheel ③

**NOTE:**

Do not depress the brake lever when the wheel is off the motorcycle otherwise the brake pads will be forced shut.

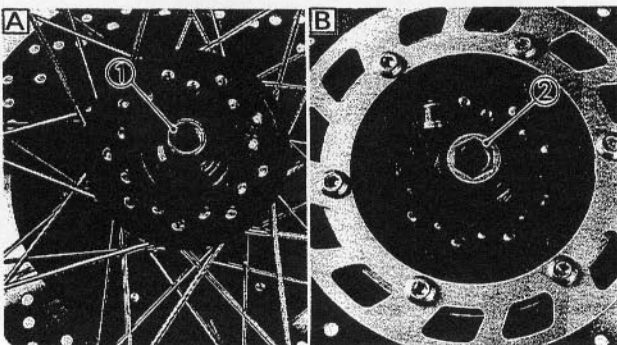

6. Remove:
  - Collar ①
  - Gear unit (speedometer) ②

- A** Right side  
**B** Left side

7. Remove:
  - Circlip ①
  - Washer ②
  - Meter clutch ③
  - Meter gear ④
  - Washer ⑤

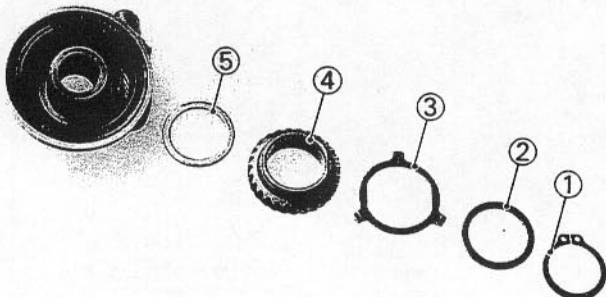

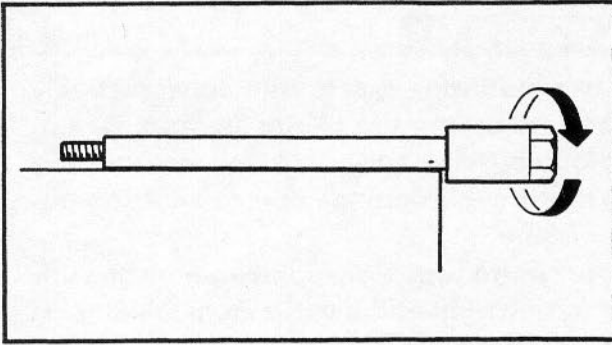

**INSPECTION**

1. Eliminate any corrosion from parts.
2. Inspect:
  - Wheel axle
    - Roll the axle on a flat surface.
    - Bends → Replace.

**⚠ WARNING**

Do not attempt to straighten a bent axle.

3. Inspect:
  - Tire
    - Wear/Damage → Replace.
    - Refer to the "TIRE INSPECTION" section in the CHAPTER 3.
  - Wheel
    - Cracks/Bends/Warpage → Replace.
    - Refer to the "WHEEL INSPECTION" section in the CHAPTER 3.

4. Check:
  - Spoke(s)
    - Bend/Damage → Replace.
    - Loose spoke(s) → Retighten.
    - Turn the wheel and tap the spokes with a screw driver.

**NOTE:**

A tight spoke will emit a clear, ringing tone; a loose spoke will sound flat.

5. Tighten:
  - Loose spokes

**Spoke:**

2 Nm (0.2 m•kg, 1.4 ft•lb)

**NOTE:**

Check the wheel runout after tightening spoke.

6. Measure:
  - Wheel runout
    - Out of specification → Check the wheel and bearing play.

**Rim runout limits:**

Vertical ①: 2.0 mm (0.08 in)

Lateral ②: 2.0 mm (0.08 in)

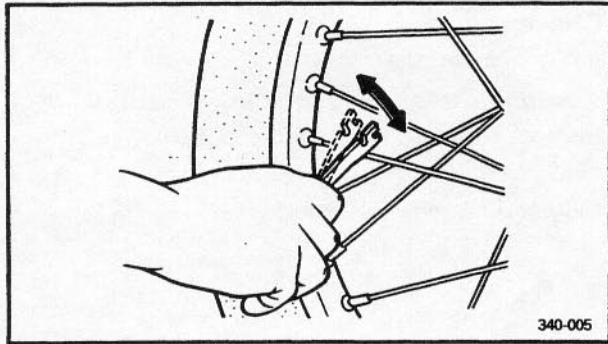

340-005

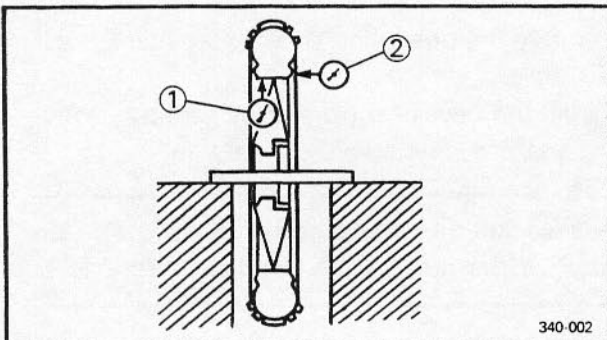

340-002

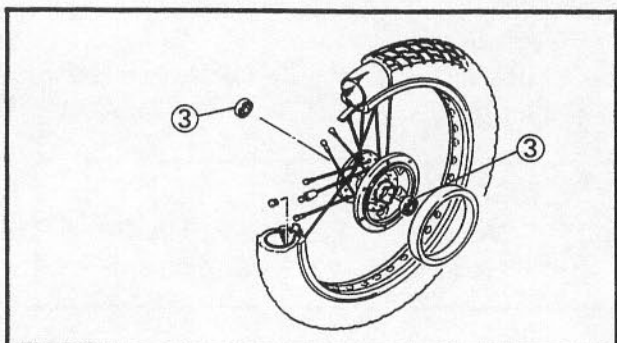
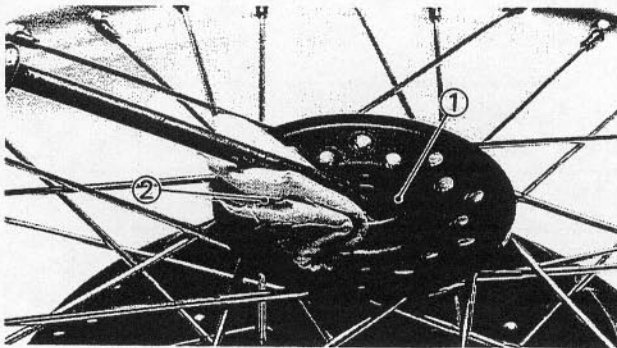
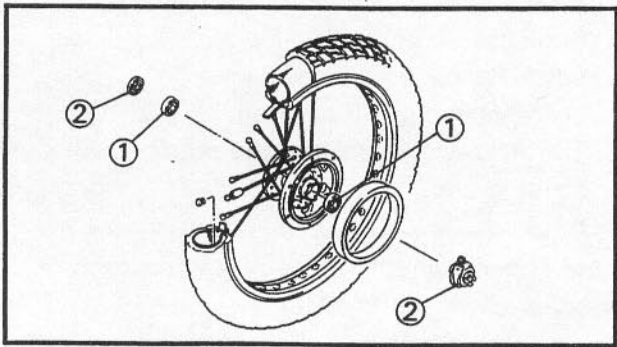
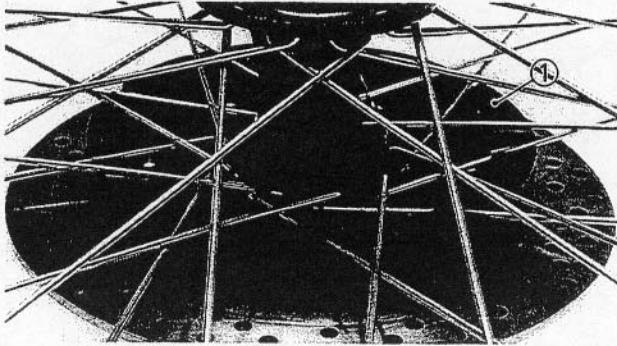
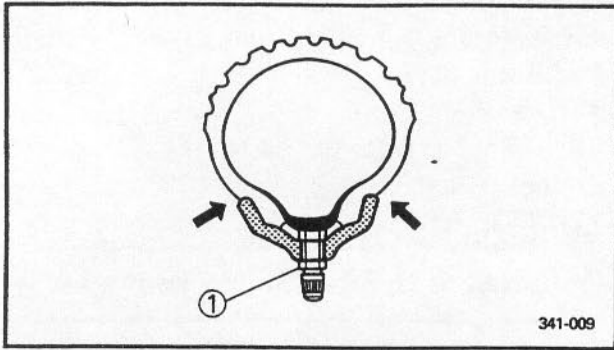

### ⚠ WARNING

- After mounting a tire, ride conservatively to allow proper tire to rim seating. Failure to do so may cause an accident resulting in motorcycle damage and possible operator injury.
- After a tire repair or replacement, be sure to torque/tighten the valve stem locknut ① to specification.



Valve stem locknut:  
1.5 Nm (0.15 m•kg, 1.1 ft•lb)

#### 7. Inspect:

- Rubber damper ①  
Cracks/Damage → Replace.

#### 8. Check:

- Wheel bearings ①  
Bearings allow play in the wheel hub or wheel turns roughly → Replace.
- Oil seals ②  
Wear/Damage → Replace.

#### \*\*\*\*\* Oil seal and wheel bearing replacement steps:

- Clean the outside of the wheel hub.
- Remove the oil seals ① use a flat-head screw driver.

#### NOTE:

Place a rag ② on the outer edge to prevent damage.

- Remove the bearings ③ using a general bearing puller.
- Install the new bearing and oil seal by reversing the previous steps.

#### NOTE:

Use a socket ④ that matches the outside diameter of the race of the bearing and oil seal.

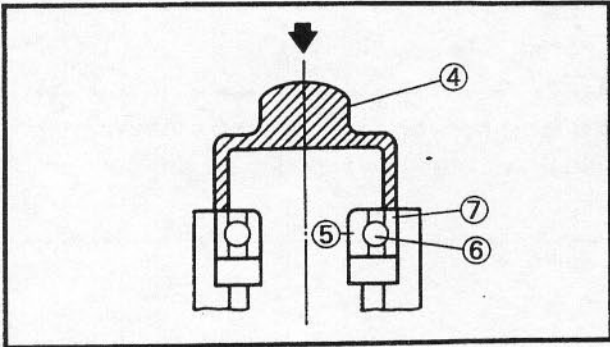

**CAUTION:**

Do not strike the center race (5) or balls (6) of the bearing. Contact should be made only with the outer race (7).

\*\*\*\*\*

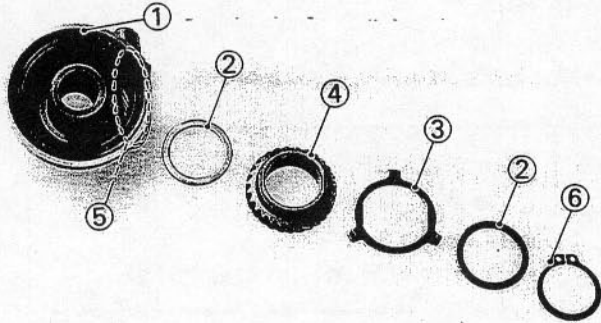

9. Inspect:

- Gear unit case (speedometer) (1)
  - Washer (2)
  - Meter clutch (3)
  - Meter gear (4)
  - Driven gear (5)
  - Circlip (6)
- Wear/Damage → Replace.

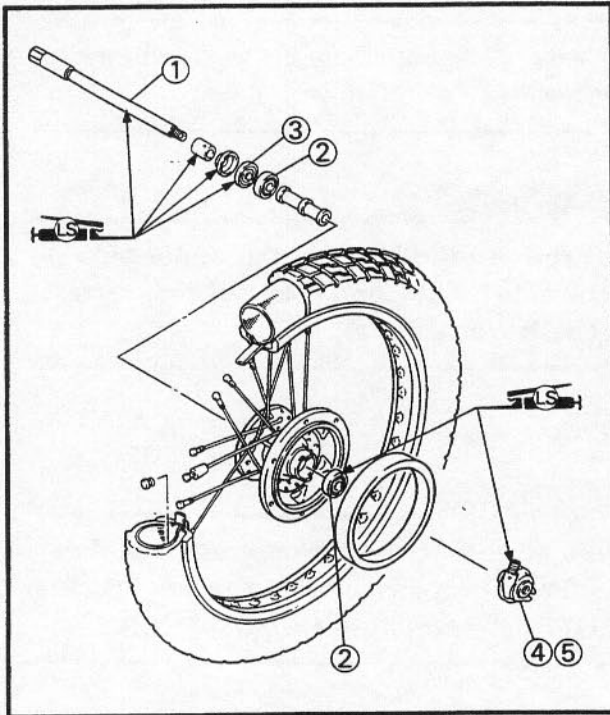

**INSTALLATION**

Reverse the "Removal" procedure. Note the following points.

1. Lubricate:

- Wheel axle (1)
- Bearings (2)
- Oil seal (lip) (3)
- Drive (4)/Driven gear (5) (speedometer)

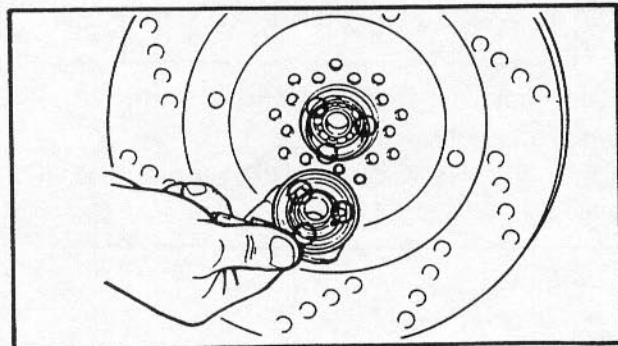
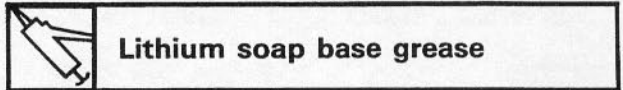

2. Install:

- Gear unit assembly

**NOTE:**

Make sure the projections on the meter clutch are meshed with the flats in the wheel hub.



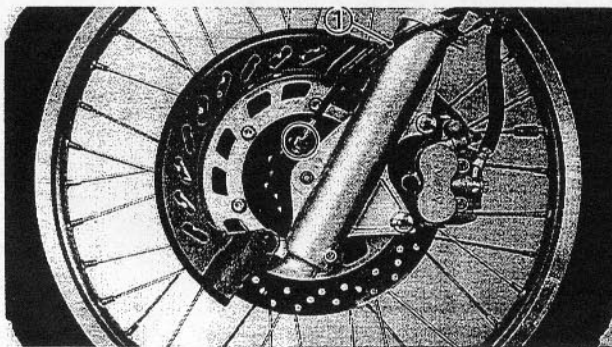
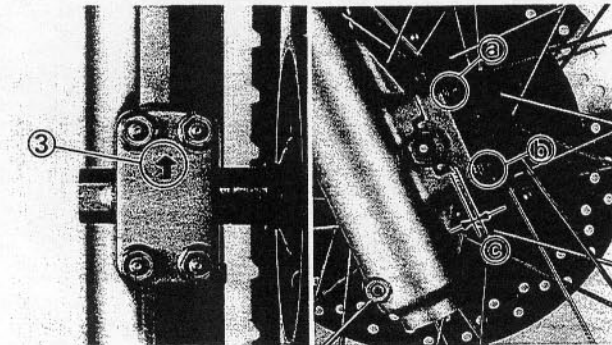
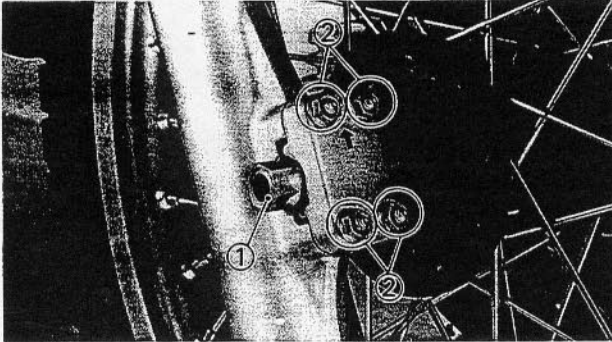
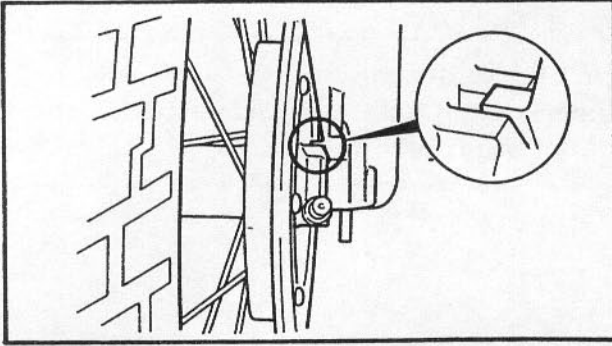

## 3. Install:

- Front wheel assembly

**NOTE:**

Be sure the boss on the outer fork tube correctly engages with the locating slot on the gear unit assembly.

## 4. Tighten:

- Wheel axle ①
- Nut (axle holder) ②

**Wheel axle:**

58 Nm (5.8 m•kg, 42 ft•lb)

**Nut (axle holder):**

9 Nm (0.9 m•kg, 6.5 ft•lb)

**NOTE:**

The axle holder should be installed with the arrow mark ③ facing upward.

**CAUTION:**

First tighten the nuts on the upper side ① of the axle holder, and then tighten the nuts on the lower side ②.

③ Space

**CAUTION:**

Make sure that the speedometer cable ① is routed properly. Refer to the "CABLE ROUTING" section in the CHAPTER 2.

**STATIC WHEEL BALANCE ADJUSTMENT****NOTE:**

- After replacing the tire and/or rim, wheel balance should be adjusted.
- Adjust the wheel balance with brake disc installed.

## 1. Remove:

- Balancing weight

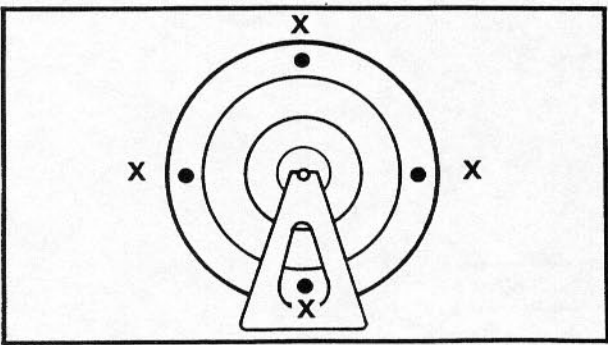
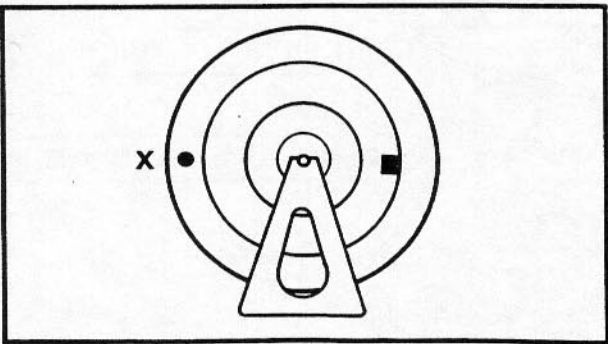
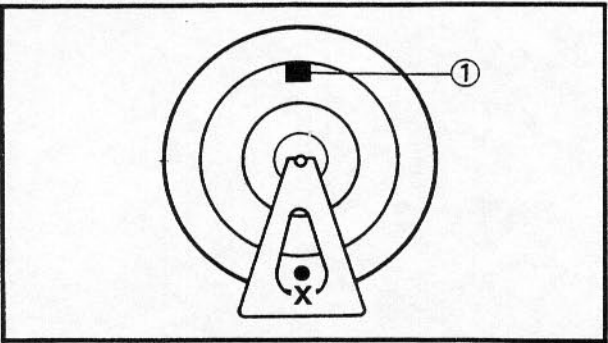
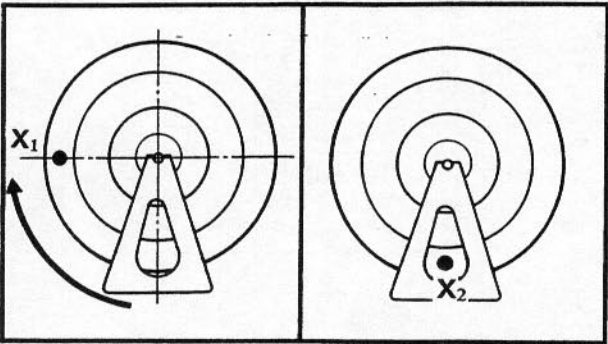
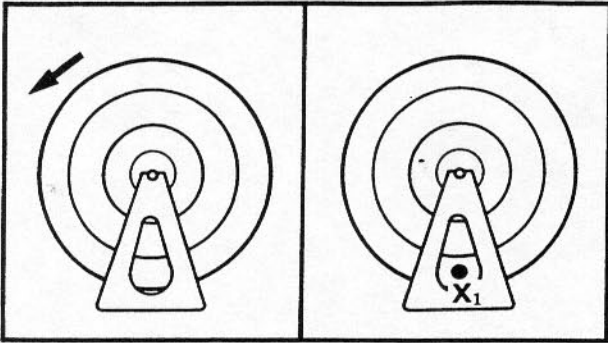

2. Set the wheel on a suitable stand.

3. Find:  
•Heavy spot

\*\*\*\*\*

**Procedure:**

- a. Spin the wheel and wait for it to rest.
- b. Put an "X<sub>1</sub>" mark on the wheel bottom spot.
- c. Turn the wheel so that the "X<sub>1</sub>" mark is 90° up.
- d. Let the wheel fall and wait for it to rest. Put an "X<sub>2</sub>" mark on the wheel bottom spot.
- e. Repeat the above b., c., and d. several times until these marks come to the same spot.
- f. This spot is the heavy spot "X".

\*\*\*\*\*

4. Adjust:  
•Wheel balance

\*\*\*\*\*

**Adjusting steps:**

- Install a balancing weight ① on the rim exactly opposite to the heavy spot "X".

**NOTE:** \_\_\_\_\_

Start with the smallest weight.

- Turn the wheel so that the heavy spot is 90° up.
- Check that the heavy spot is at rest there. If not, try another weight until the wheel is balanced.

\*\*\*\*\*

5. Check:  
•Wheel balance

\*\*\*\*\*

**Checking steps:**

- Turn the wheel so that it comes to each point as shown.
- Check that the wheel is at rest at each point. If not, readjust the wheel balance.

\*\*\*\*\*



REAR WHEEL

- ① Caliper bracket
- ② Collar
- ③ Dust cover
- ④ Oil seal
- ⑤ Bearing
- ⑥ Collar
- ⑦ Rear wheel
- ⑧ Rubber damper
- ⑨ Bearing
- ⑩ Clutch hub
- ⑪ Collar
- ⑫ Driven sprocket
- ⑬ Bearing
- ⑭ Oil seal
- ⑮ Collar
- ⑯ Drive chain
- ⑰ Wheel axle

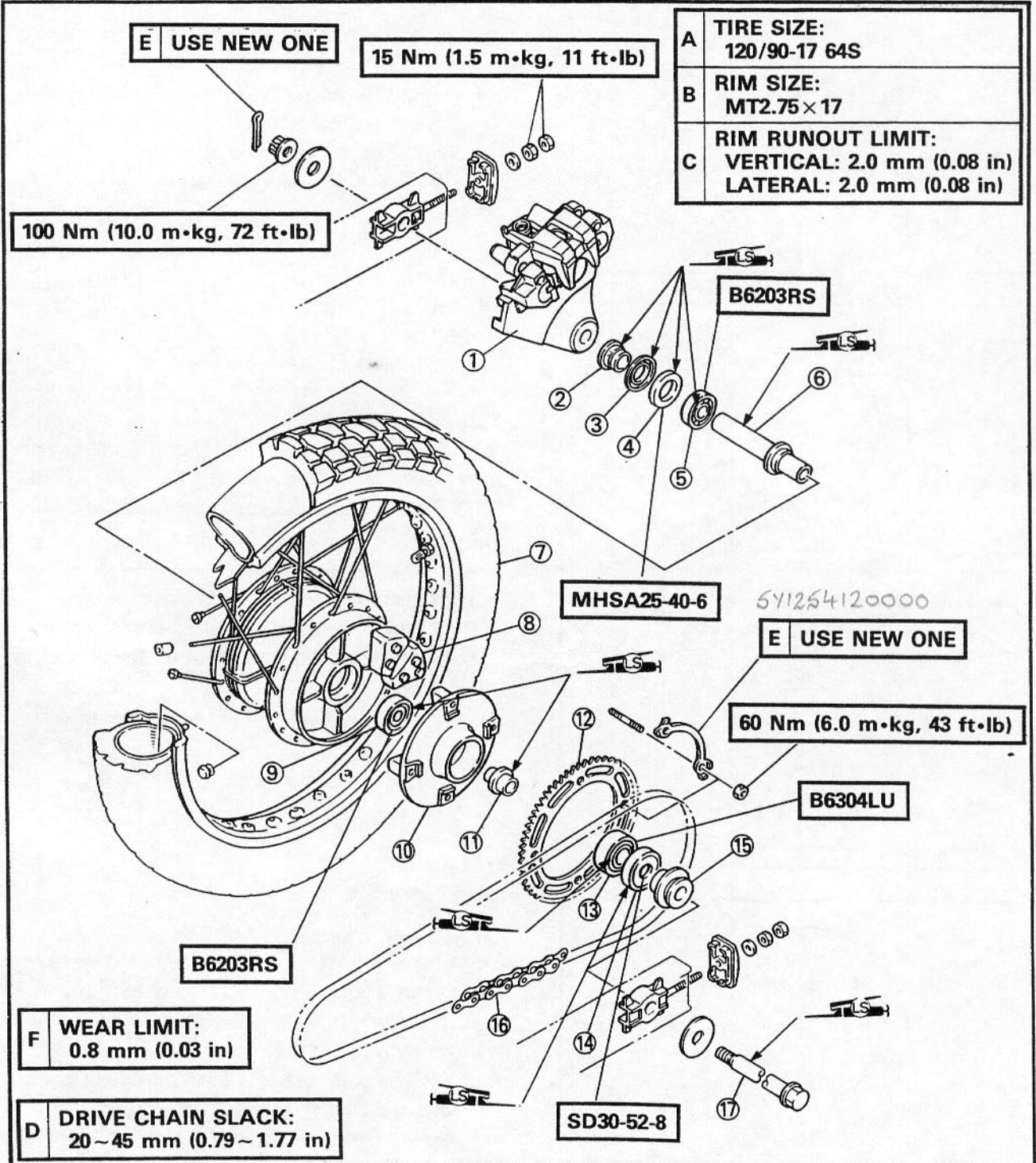



## REMOVAL

### **⚠ WARNING**

Securely support the motorcycle so there is no danger of it falling over.

1. Place the motorcycle on a level place.
2. Elevate the rear wheel by placing a suitable stand under the frame and engine.

3. Remove:
  - Caliper cover
  - Retaining bolt
  - Brake pads
  - Shim
  - Pad spring

Refer to the "FRONT AND REAR BRAKE—BRAKE PAD REPLACEMENT" section.

### **NOTE:**

Do not depress the brake pedal when the wheel is off the motorcycle as the brake pads will be forced shut.

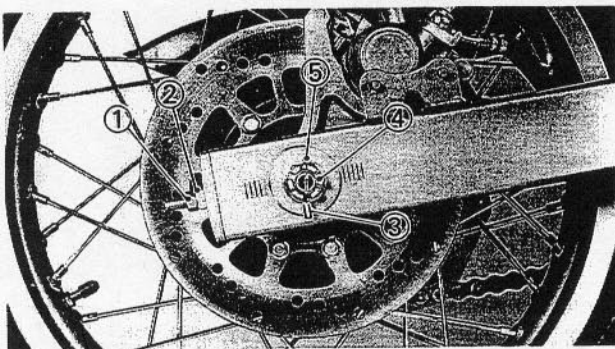

4. Loosen:
  - Lock nut ①
  - Adjust nut ②

5. Remove:
  - Cotter pin ③
  - Axle nut ④
  - Washer ⑤

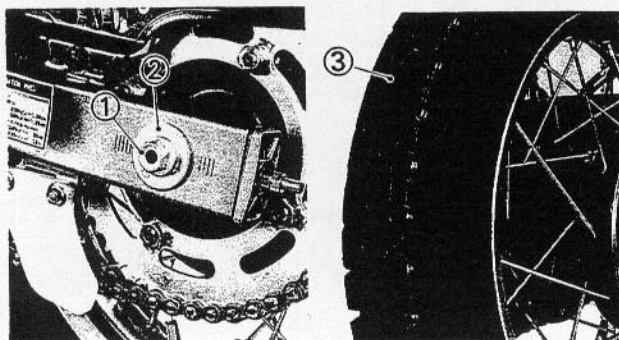

6. Remove:
  - Wheel axle ①
  - Washer ②
  - Rear wheel ③

### **NOTE:**

Before removing the rear wheel, push the wheel forward and remove the driven chain.

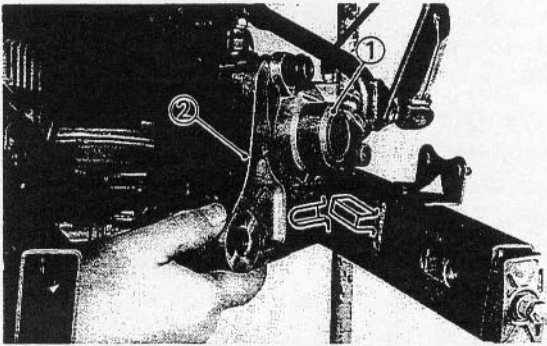

7. Remove:
- Caliper body ①
  - Caliper bracket ②

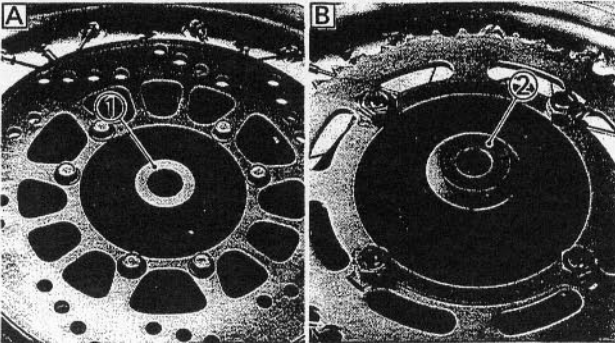

8. Remove:
- Collar ①
  - Collar ②

- A** Right side  
**B** Left side

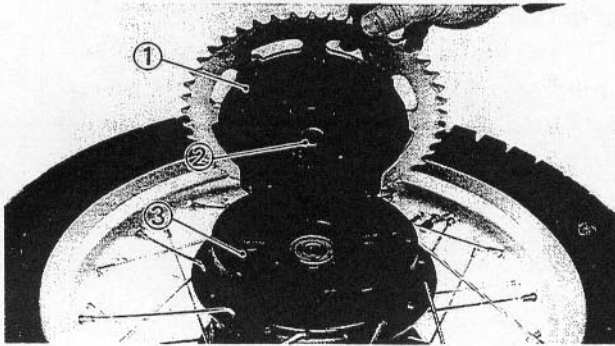

9. Remove:
- Clutch hub ①
  - Collar ②
  - Rubber damper ③

**INSPECTION**

1. Inspect:
- Wheel axle
  - Tire
  - Wheel
  - Rubber damper
- Refer to the "FRONT WHEEL—INSPECTION" section.
2. Check:
- Spoke(s)
- Refer to the "FRONT WHEEL—INSPECTION" section.
3. Measure:
- Wheel runout
- Refer to the "FRONT WHEEL—INSPECTION" section.



4. Check:

- Oil seals
- Wheel bearings

Refer to the "FRONT WHEEL—INSPECTION" section.

5. Inspect:

- Caliper bracket ①  
Cracks/Damage → Replace.

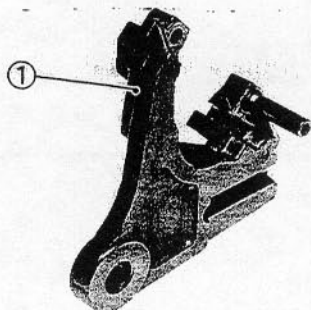

**INSTALLATION**

Reverse the "Removal" procedure.  
Note the following points.

1. Lubricate:

- Wheel axle
- Bearings
- Oil seals (lip)



**Lithium soap base grease**

2. Adjust:

- Drive chain slack



**Drive chain slack:**  
20 ~ 45 mm (0.79 ~ 1.77 in)

Refer to the "DRIVE CHAIN SLACK ADJUSTMENT" section in the CHAPTER 3.

3. Tighten:

- Axle nut
- Locknut



**Axle nut:**  
100 Nm (10.0 m•kg, 72 ft•lb)  
**Locknut (chain puller):**  
15 Nm (1.5 m•kg, 11 ft•lb)

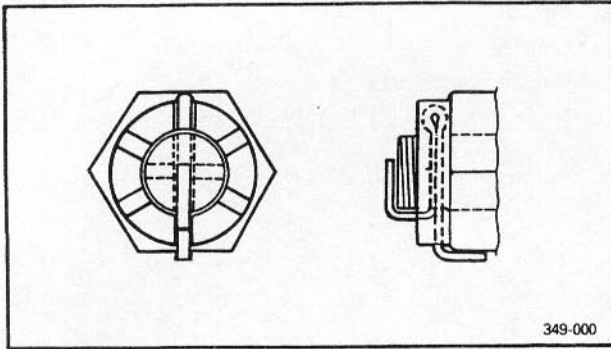

**NOTE:** \_\_\_\_\_

Do not loosen the axle nut after torque tightening. If the axle nut groove is not aligned with the wheel shaft cotter pin hole, align groove to hole by tightening up on the axle nut.

**4. Install:**

- Cotter pin

**NOTE:** \_\_\_\_\_

Bend the ends of the cotter pin as illustration.

**! WARNING** \_\_\_\_\_

Always use a new cotter pin.

**5. Install:**

- Pad spring
- Shim
- Brake pads
- Retaining bolt
- Caliper cover

Refer to the "FRONT AND REAR BRAKE—BRAKE PAD REPLACEMENT" section.



**Retaining bolt:**

**23 Nm (2.3 m•kg, 17 ft•lb)**

YB272004

**STATIC WHEEL BALANCE ADJUSTMENT****NOTE:** \_\_\_\_\_

- After replacing the tire and/or rim, wheel balance should be adjusted.
- Adjust the wheel balance with brake disc and clutch hub installed.

**1. Adjust:**

- Wheel balance

Refer to the "FRONT WHEEL—STATIC WHEEL BALANCE ADJUSTMENT" section.

## FRONT AND REAR BRAKE

- |   |   |
|---|---|
| <ul style="list-style-type: none"> <li>① Master cylinder cap</li> <li>② Diaphragm</li> <li>③ Master cylinder kit</li> <li>④ Master cylinder</li> <li>⑤ Brake hose</li> <li>⑥ Brake caliper</li> <li>⑦ Pad spring</li> </ul> | <ul style="list-style-type: none"> <li>⑧ Piston</li> <li>⑨ Piston seal</li> <li>⑩ Dust seal</li> <li>⑪ Brake pads</li> <li>⑫ Shim</li> <li>⑬ Brake disc</li> <li>⑭ Rubber damper</li> </ul> |
|---|---|

**E** The longer tangs (✱) of the pad spring must point in the outside direction.

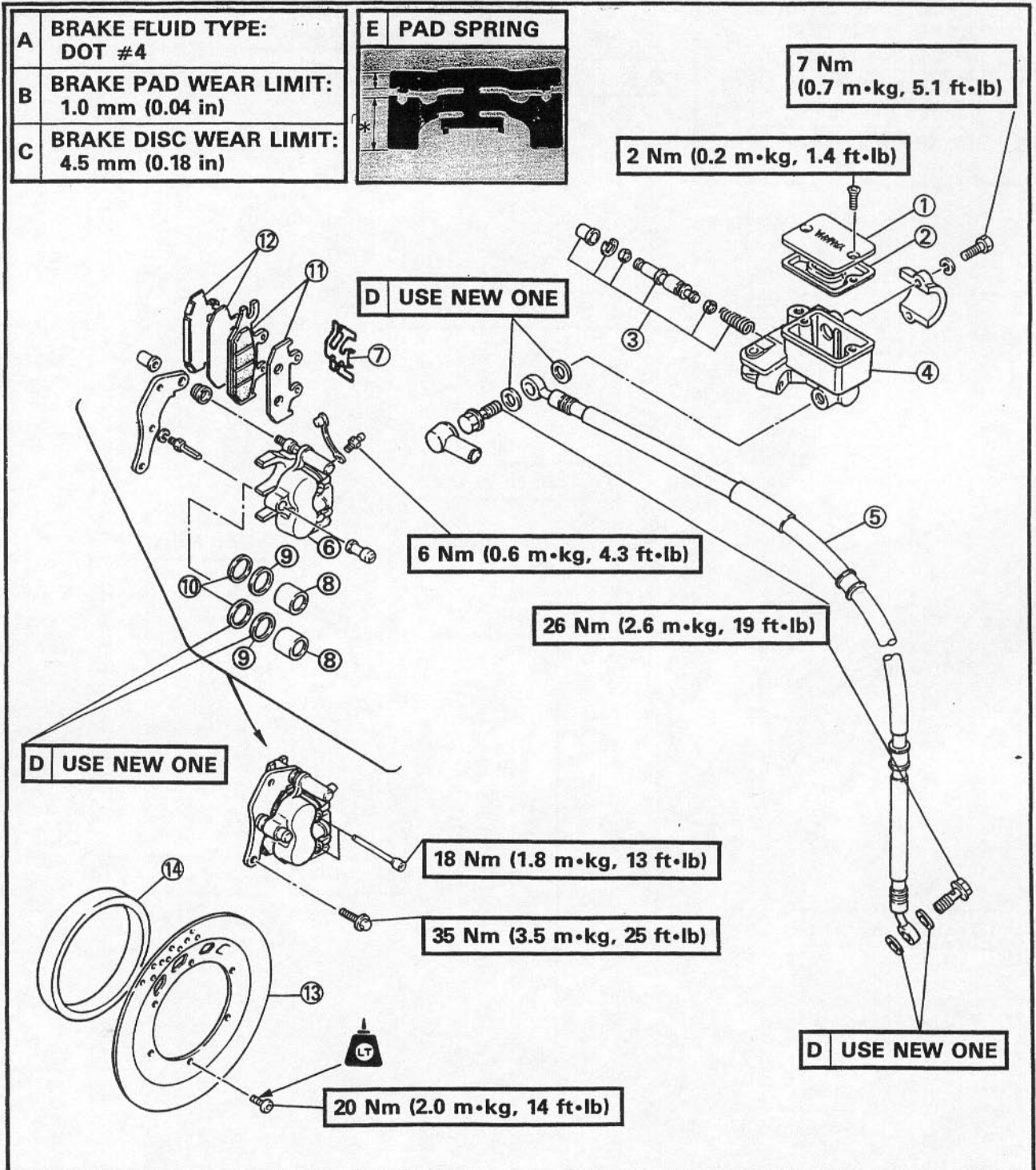

- ① Reservoir tank cap
- ② Bush
- ③ Diaphragm
- ④ Reservoir tank
- ⑤ Reservoir hose
- ⑥ Master cylinder
- ⑦ Master cylinder kit
- ⑧ Brake hose
- ⑨ Brake pedal
- ⑩ Brake caliper
- ⑪ Piston
- ⑫ Piston seal
- ⑬ Dust boot
- ⑭ Ring (dust boot)
- ⑮ Shim
- ⑯ Brake pads
- ⑰ Pad spring
- ⑱ Caliper bracket
- ⑲ Brake disc

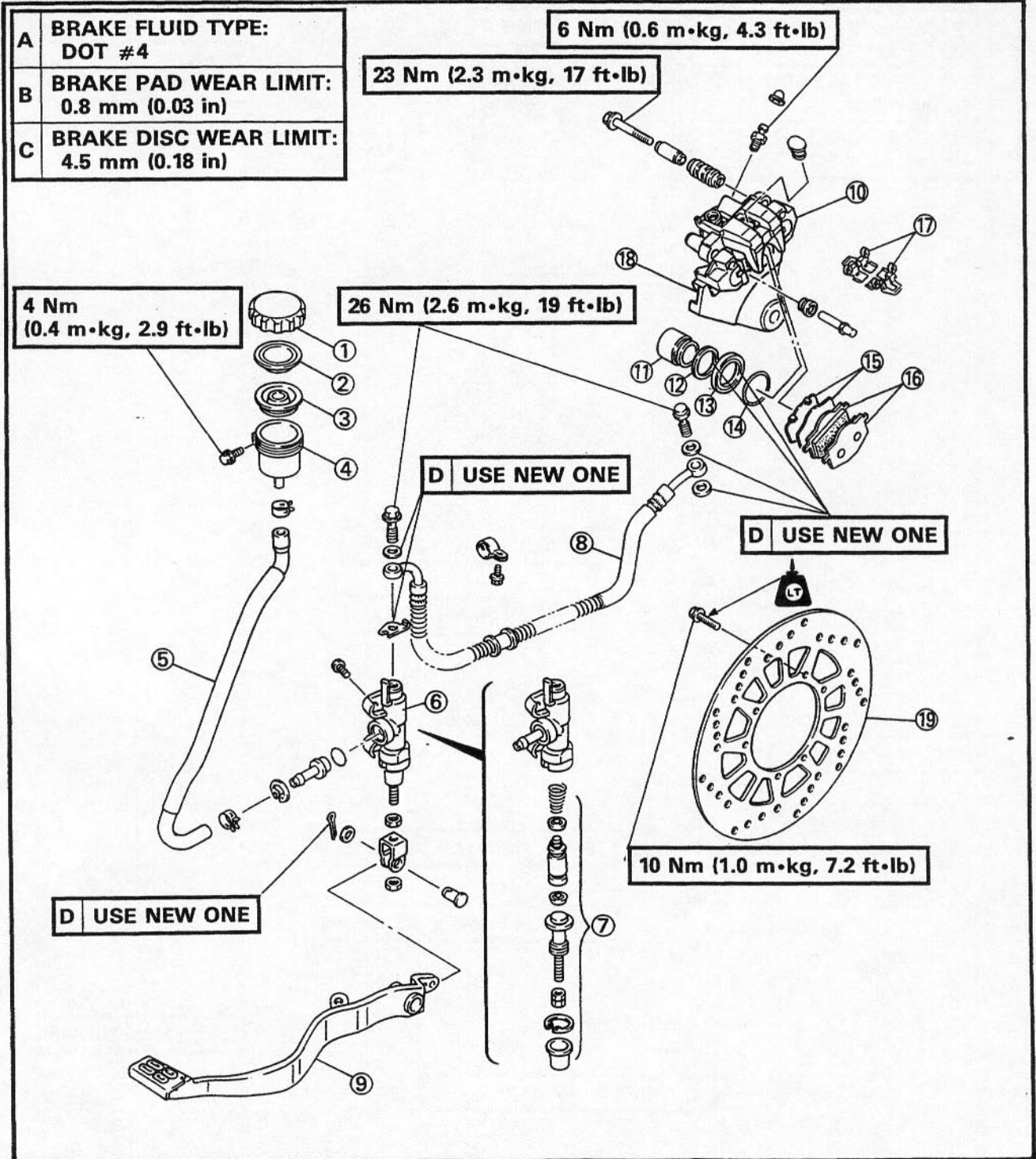



**CAUTION:**

Disc brake components rarely require disassembly. **DO NOT:**

- Disassemble components unless absolutely necessary.
- Use solvents on internal brake component.
- Use contaminated brake fluid for cleaning.
- Allow brake fluid to come in contact with the eyes otherwise eye injury may occur.
- Allow brake fluid to contact painted surfaces or plastic parts otherwise damage may occur.
- Disconnect any hydraulic connection otherwise the entire system must be disassembled, drained, cleaned, and then properly filled and bled after reassembly.

**BRAKE PAD REPLACEMENT****NOTE:**

It is not necessary to disassemble the brake caliper and brake hose to replace the brake pads.

**⚠ WARNING**

Securely support the motorcycle there is no danger of falling over.

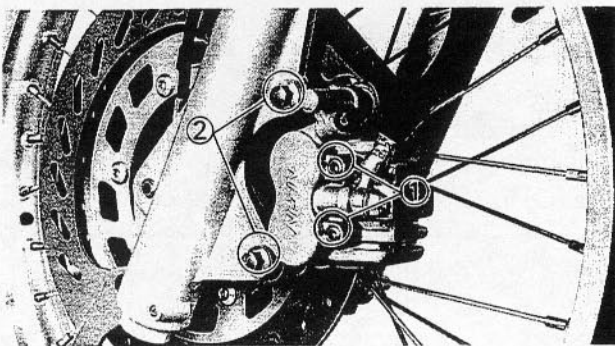
**Front Brake**

1. Loosen:
  - Retaining bolts ①
2. Remove:
  - Bolts (caliper body) ②
  - Retaining bolts ①

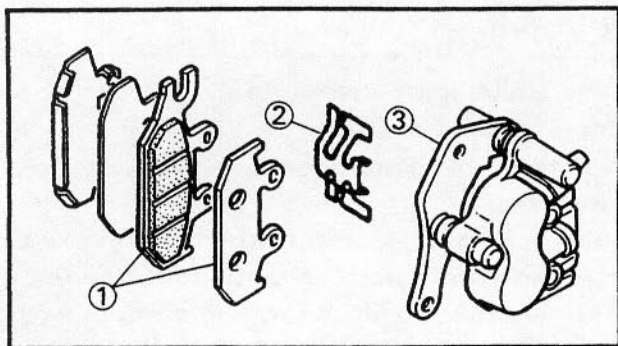

3. Remove:
- Brake pads ①
  - Pad spring ②
  - Caliper bracket ③

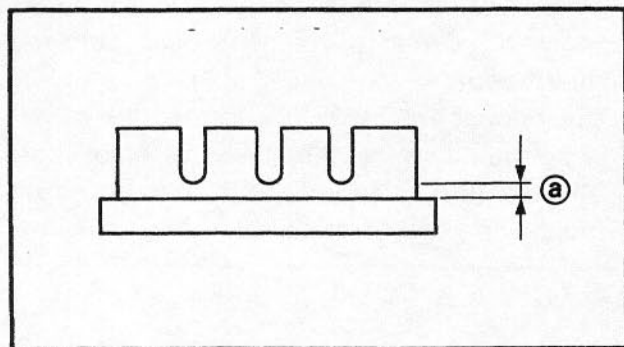

**NOTE:** \_\_\_\_\_

- Replace the pad spring if the pad replacement is required.
- Replace the pads as a set if either is found to be worn to the wear limit.



**Wear limit (a):**  
**1.0 mm (0.04 in)**

- Replace the pad shim if the pad replacement is required.

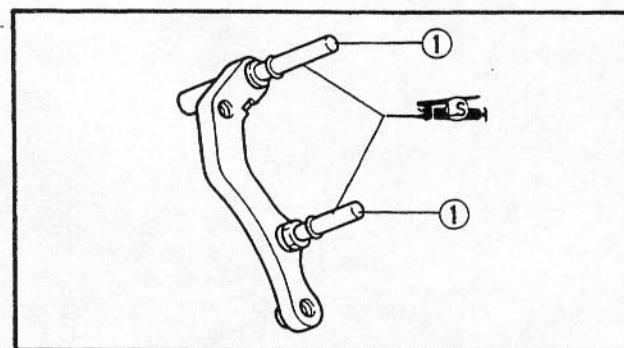

4. Lubricate:
- Guide pins ①



**Lithium soap base grease**

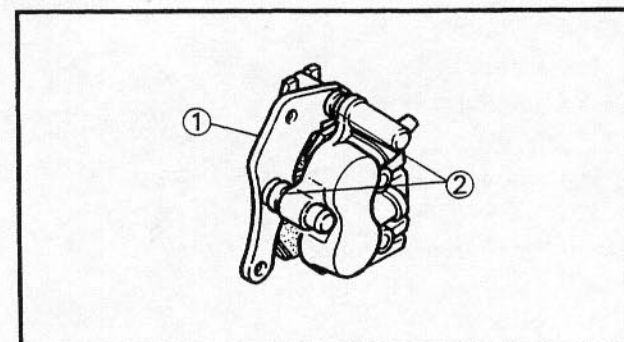

5. Install:
- Caliper bracket ① (to caliper body)

**NOTE:** \_\_\_\_\_

Place the rubber boot ② securely in the groove of guide pin when installing the caliper body.

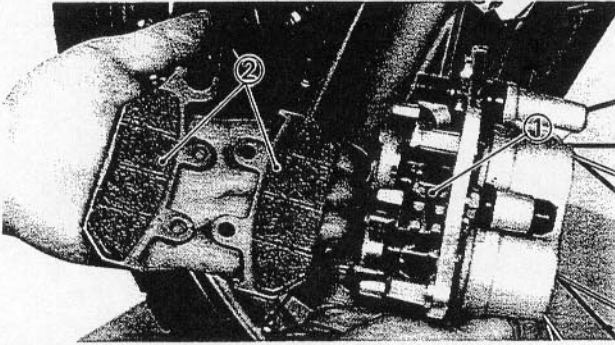

6. Install:
- Pad spring (1) (new)
  - Brake pad assembly (2) (new)

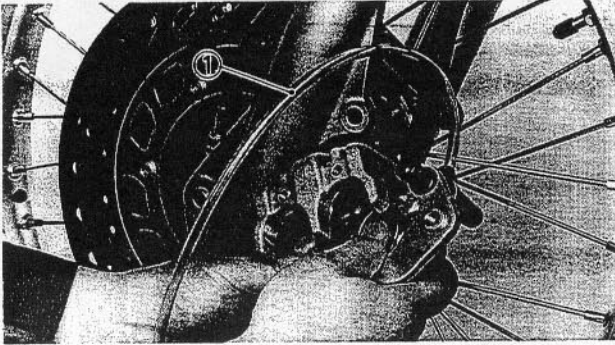

\*\*\*\*\*

**Installation steps:**

- Connect the clear plastic tube (1) tightly to the caliper bleedscrew. Then, place the other end of this hose into an open container.
- Loosen the caliper bleed screw and push the piston into the caliper by your finger.
- Tighten the caliper bleed screw.

	<p><b>Caliper bleed screw:</b> 6 Nm (0.6 m•kg, 4.3 ft•lb)</p>
---	---

- Install the pad spring (new) and brake pad assembly (new).

**NOTE:**

The longer tangs (\*) of the pad spring must point in the outside direction.

\*\*\*\*\*

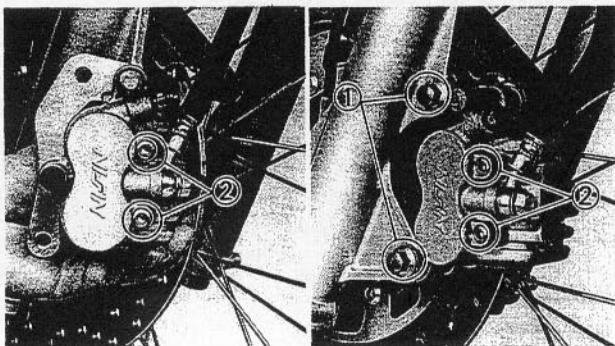
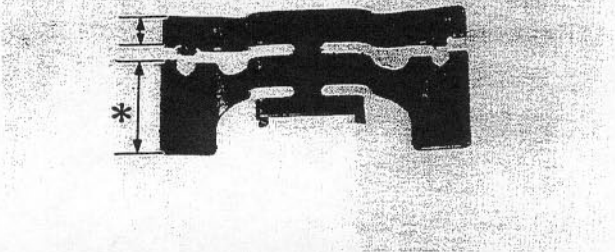

7. Install:
- Retaining bolts (2)
8. Install:
- Bolts (caliper body) (1)
9. Tighten:
- Bolts (caliper body) (1)
  - Retaining bolts (2)

	<p><b>Bolt (caliper body):</b> 35 Nm (3.5 m•kg, 25 ft•lb)</p> <p><b>Retaining bolt:</b> 18 Nm (1.8 m•kg, 13 ft•lb)</p>
---	--



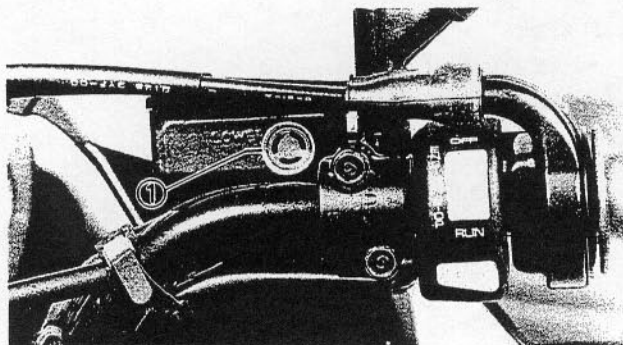

10. Inspect:

- Brake fluid level

Refer to the "BRAKE FLUID INSPECTION" section in the CHAPTER 3.

① "LOWER" level line

11. Check:

- Brake lever operation

A softy or spongy filling → Bleed brake system.

Refer to the "AIR BLEEDING" section in the CHAPTER 3.

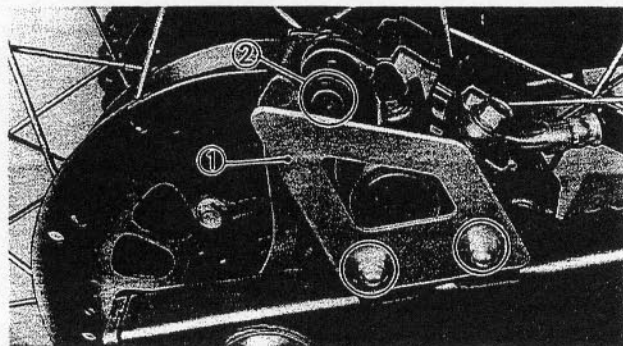

Rear Brake

1. Remove:

- Caliper cover ①
- Retaining bolt ②

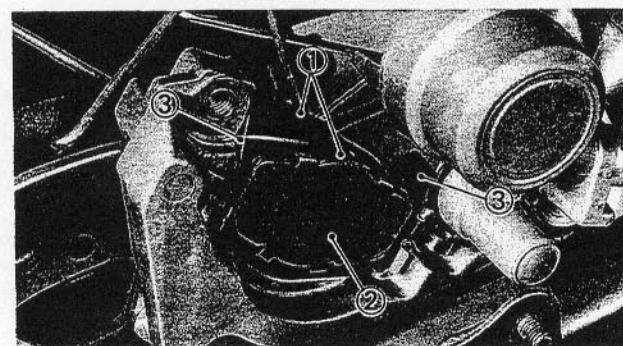

2. Remove:

- Brake pads ①
- Shim ②
- Pad springs ③

NOTE:

Turn the caliper body clockwise.

NOTE:

- Replace the spring if the pad replacement is required.
- Replace the pads as a set if either is found to be worn to the wear limit.



Wear limit (a):  
0.8 mm (0.03 in)

- Replace the pad shim if the pad replacement is required.

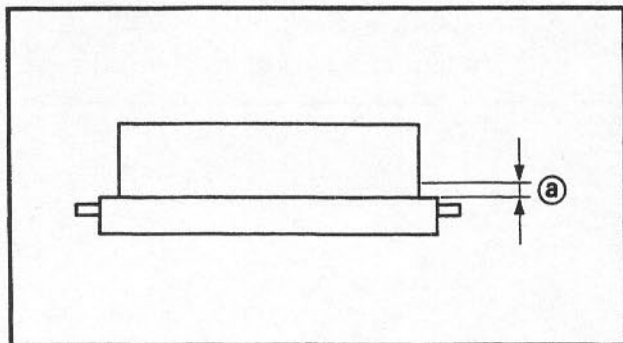

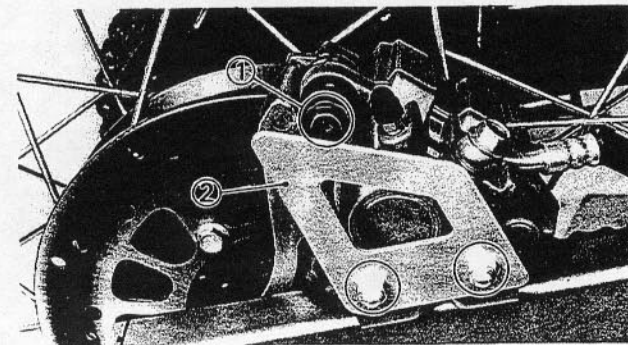
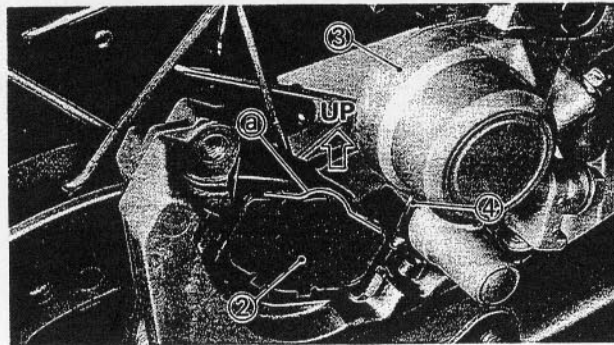
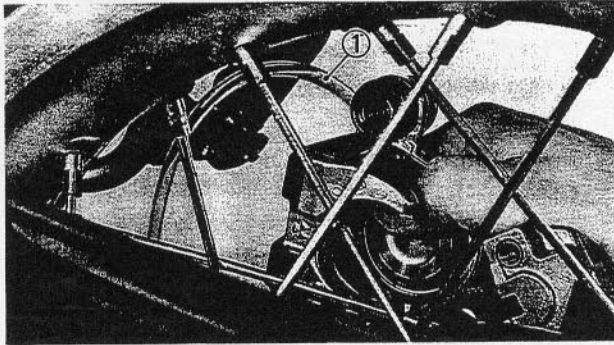
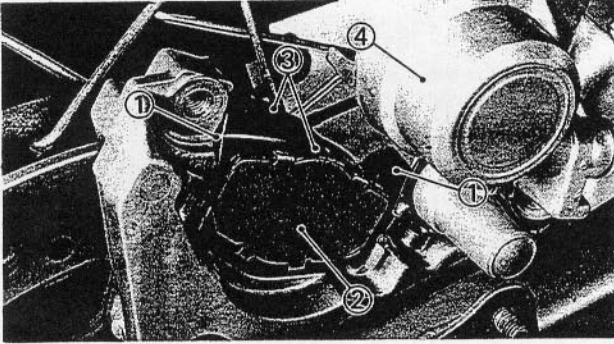

3. Install:
- Pad springs ①
  - Shim ②
  - Brake pads ③
  - Caliper body ④

\*\*\*\*\*

**Installation steps:**

- Connect the clear plastic tube ① tightly to the caliper bleed screw. Then, place the other end of this hose into an open container.
- Loosen the caliper bleed screw and push the piston into the caliper by your finger.
- Tighten the caliper bleed screw.

	<p><b>Caliper bleed screw:</b> 6 Nm (0.6 m•kg, 4.3 ft•lb)</p>
---	---

- Install the pad shim (new) ② to the piston side brake pad.
- Install the pad springs (new) and brake pads (new).

**NOTE:** \_\_\_\_\_

Be sure to position the pad so that its round side ① is upward.

- Install the caliper body ③.

**NOTE:** \_\_\_\_\_

Place the rubber boot ④ securely in the groove of guide pin when installing the caliper body.

\*\*\*\*\*

4. Install:
- Retaining bolt ①

	<p><b>Retaining bolt:</b> 23 Nm (2.3 m•kg, 17 ft•lb)</p>
---	--

5. Install:
- Caliper cover ②

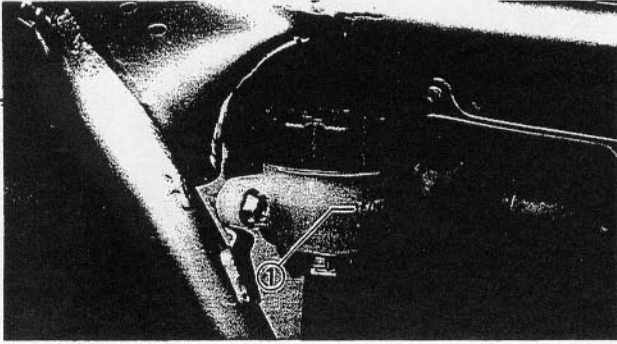

6. Inspect:
  - Brake fluid level  
Refer to the "BRAKE FLUID INSPECTION" section in the CHAPTER 3.

① "LOWER" level line

7. Check:
  - Brake pedal operation  
A softy or spongy filling → Bleed brake system.  
Refer to the "AIR BLEEDING" section in the CHAPTER 3.

## CALIPER DISASSEMBLY

**NOTE:** \_\_\_\_\_

Before disassembling the front brake caliper or rear brake caliper, drain the brake system of its brake fluid.

\_\_\_\_\_

**⚠ WARNING** \_\_\_\_\_

Securely support the motorcycle there is no danger of falling over.

\_\_\_\_\_

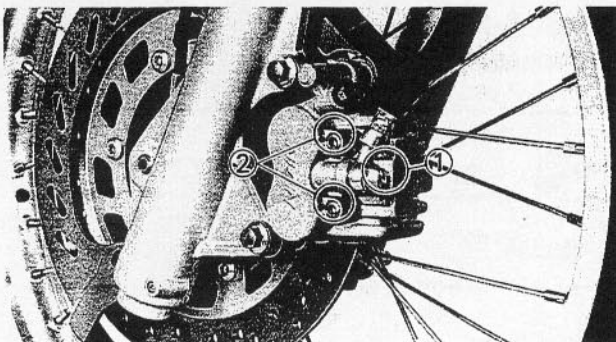

### Front Brake

1. Loosen:
  - Union bolt ①

**NOTE:** \_\_\_\_\_

Loosen slightly so that brake fluid does not leak out.

\_\_\_\_\_

- Retaining bolts ②



2. Remove:

- Bolts (caliper body)
- Retaining bolts
- Brake pads
- Pad spring

Refer to the "BRAKE PAD REPLACEMENT" section.

3. Remove:

- Union bolt ①
- Copper washers ②

**NOTE:** \_\_\_\_\_

Place the container under the caliper to catch the standing brake fluid.

4. Remove:

- Caliper bracket ①
- Piston ②
- Dust seal ③
- Piston seal ④

\*\*\*\*\*

**Removal steps:**

- Blow compressed air into the tube joint opening to force out the piston from the caliper body.

**⚠ WARNING** \_\_\_\_\_

- Never try to pry out the piston.
- Cover the piston with a rag. Use care so that piston does not cause injury as it is expelled from the cylinder.

\*\*\*\*\*

**Rear Brake**

1. Loosen:

- Union bolt ①

**NOTE:** \_\_\_\_\_

Loosen slightly so that brake fluid does not leak out.

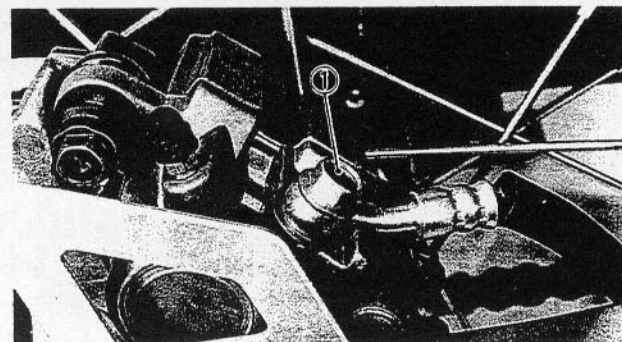
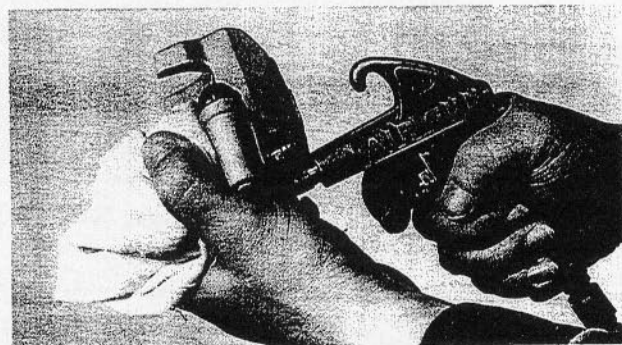
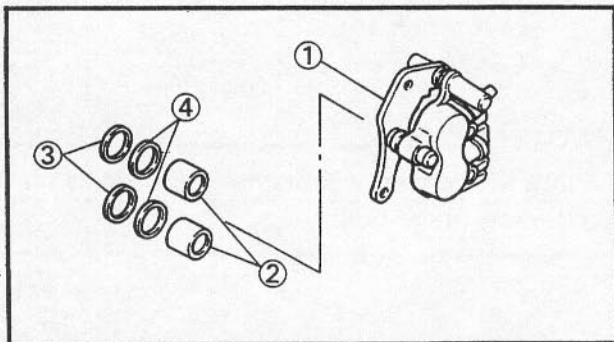
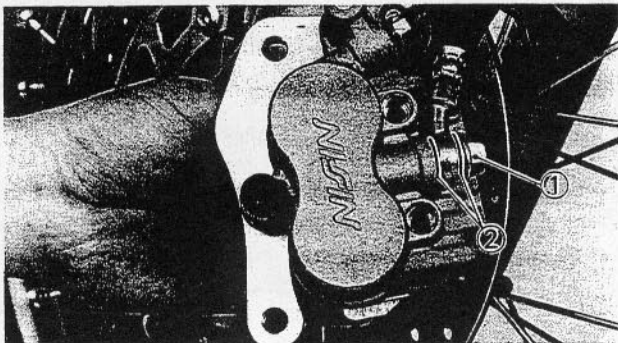

- 2. Remove:
  - Caliper cover
  - Retaining bolt
  - Brake pads
  - Shim
  - Pad springs
 Refer to the "BRAKE PAD REPLACEMENT" section.

- 3. Remove:
  - Rear wheel
  - Caliper body
  - Caliper bracket
 Refer to the "REAR WHEEL—REMOVAL" section.

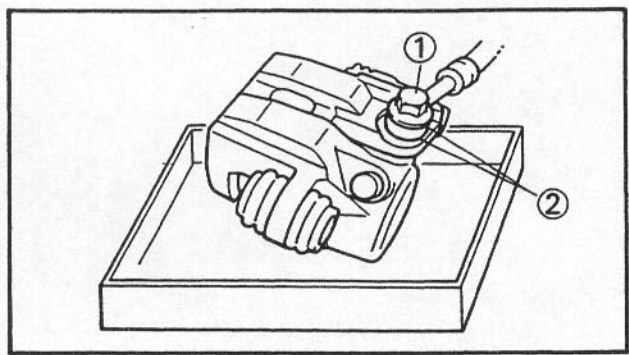

- 4. Remove:
  - Union bolt (1)
  - Copper washers (2)

**NOTE:** \_\_\_\_\_  
 Place the container under the caliper to catch the standing brake fluid.  
 \_\_\_\_\_

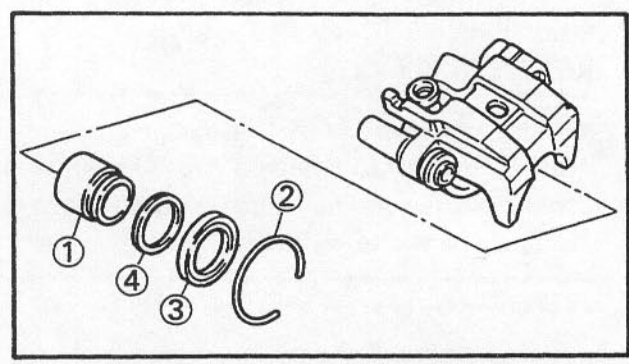

- 5. Remove:
  - Piston (1)
  - Ring (2) (dust boot)
  - Dust boot (3)
  - Piston seal (4)

**NOTE:** \_\_\_\_\_  
 Remove the piston, and then the ring (dust boot) and dust boot.  
 \_\_\_\_\_

\*\*\*\*\*

**Removal steps:**

- Blow compressed air into the tube joint opening to force out the piston from the caliper body.

**⚠ WARNING** \_\_\_\_\_

- Never try to pry out the piston.
- Cover the piston with a rag. Use care so that piston does not cause injury as it is expelled from the cylinder.

\*\*\*\*\*

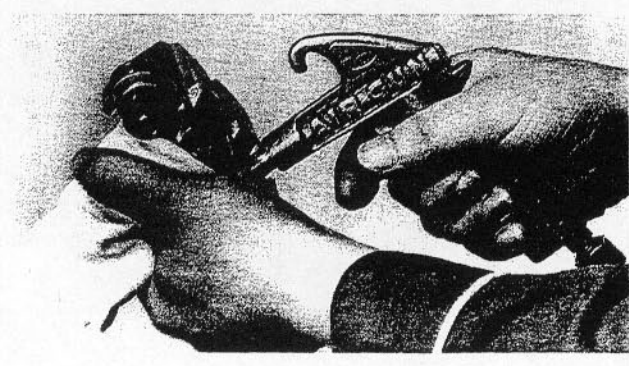

**MASTER CYLINDER DISASSEMBLY****NOTE:** \_\_\_\_\_

Before disassembling the front or rear brake master cylinders, drain the brake system of the brake fluid.

---

**⚠ WARNING** \_\_\_\_\_

Securely support the motorcycle so there is no danger of it falling over.

---

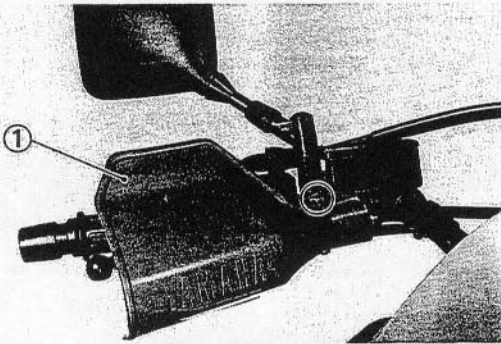
**Front Brake****1. Remove:**

- Guard ①

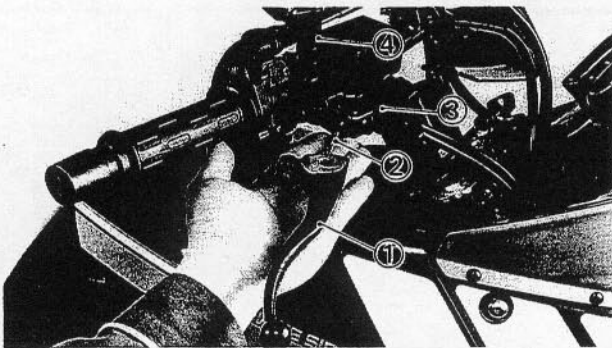
**2. Remove:**

- Brake lever ①
- Return spring ② (brake lever)
- Brake switch ③
- Mirror ④ (right)

**3. Loosen:**

- Union bolt ①

**NOTE:** \_\_\_\_\_

Loosen slightly so that brake fluid does not leak out.

---

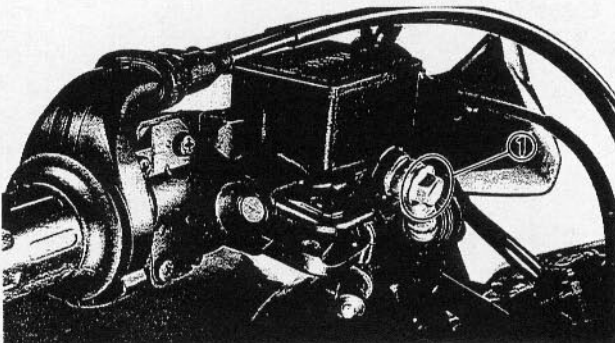



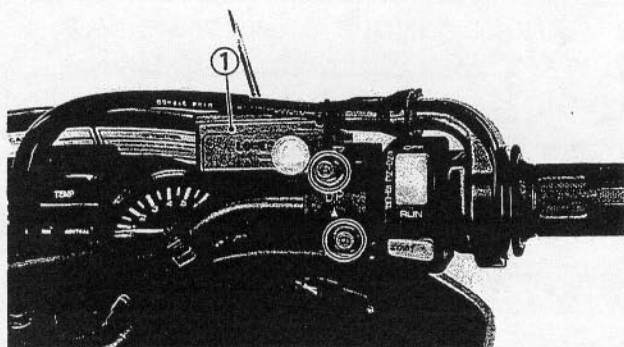

4. Remove:
  - Master cylinder ①
  - Union bolt ②
  - Copper washer ③

**NOTE:** \_\_\_\_\_  
 Place a container under the master cylinder to catch the standing brake fluid.

---

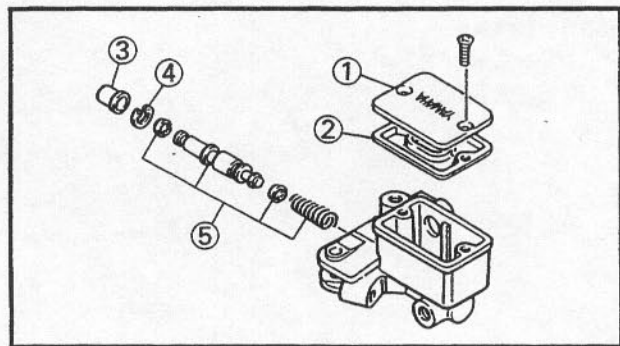
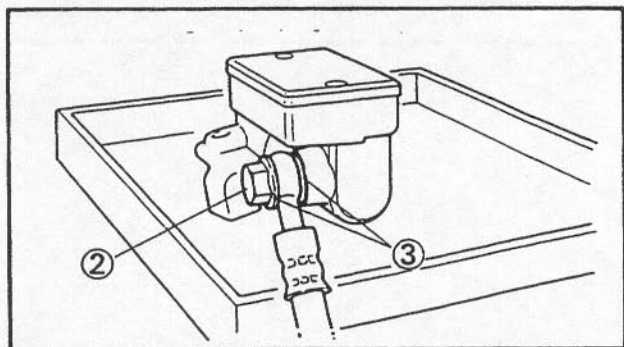

5. Remove:
  - Cap (master cylinder) ①
  - Diaphragm ②
  - Dust boot ③
  - Circlip ④
  - Master cylinder kit ⑤

**NOTE:** \_\_\_\_\_  
 Place a container under the master cylinder to catch the standing brake fluid.

---

**Rear Brake**

1. Remove:
  - Seat
  - Side cover (right)
 Refer to the "SEAT FUEL TANK AND COVER" section in the CHAPTER 3.

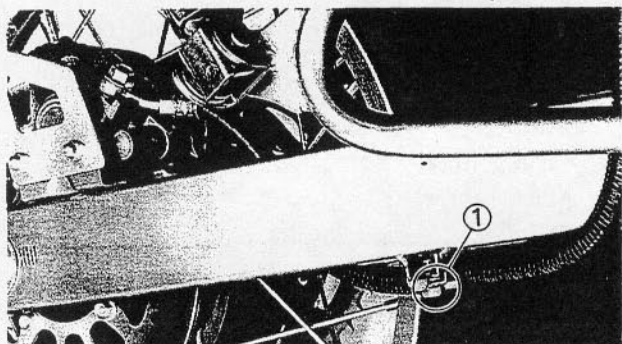

2. Remove:
- Bolt (brake hose clamp) ①

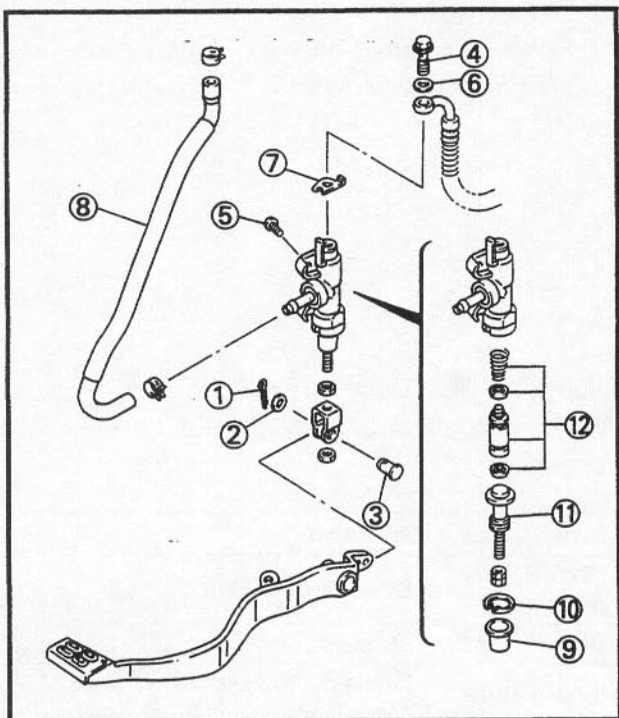

3. Remove:
- Cotter pin ①
  - Plain washer ②
  - Pin ③

4. Loosen:
- Union bolt ④

**NOTE:** \_\_\_\_\_  
Loosen slightly so that brake fluid does not leak out.

5. Remove:
- Bolts (master cylinder) ⑤

6. Remove:
- Union bolt ④
  - Copper washer ⑥
  - Lock washer ⑦

**NOTE:** \_\_\_\_\_  
Place the container under the master cylinder to catch the standing brake fluid.

7. Disconnect:
- Reservoir hose ⑧  
(from master cylinder)

**NOTE:** \_\_\_\_\_  
Place the container under the reservoir hose to catch the standing brake fluid.

8. Remove:
- Dust boot ⑨
  - Circlip ⑩
  - Adjusting rod ⑪
  - Master cylinder kit ⑫

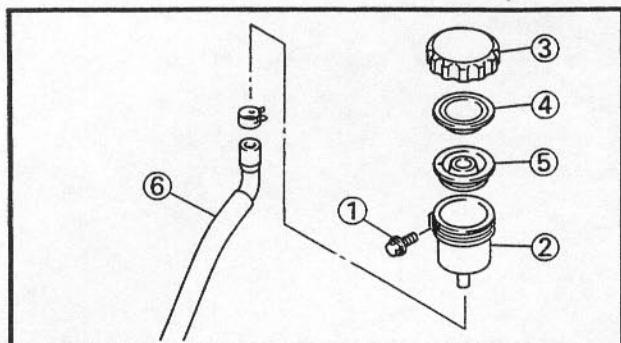

9. Remove:
- Screw ①
  - Reservoir tank ②
  - Cap ③
  - Bush (diaphragm) ④
  - Diaphragm ⑤

**NOTE:** \_\_\_\_\_  
Place the container under the reservoir tank to catch the standing brake fluid.

10. Disconnect:
- Reservoir tank hose ⑥  
(from reservoir tank)

**INSPECTION AND REPAIR**

Recommended brake component replacement schedule:

Brake pads	As required
Piston seal, dust seal	Every two years
Brake hoses	Every four years
Brake fluid	Replace only when brakes are disassembled.

**⚠ WARNING** \_\_\_\_\_

All internal parts should be cleaned in new brake fluid only. Do not use solvents will cause seals to swell and distort.

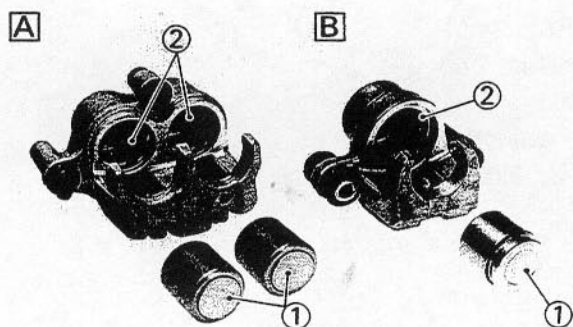

1. Inspect:
- Caliper piston ①  
Scratches/Rust/Wear → Replace caliper assembly.
  - Caliper cylinder ②  
Wear/Scratches → Replace caliper assembly.

**A** Front  
**B** Rear





## ⚠ WARNING

Replace the piston seals and dust seals whenever a caliper is disassembled.

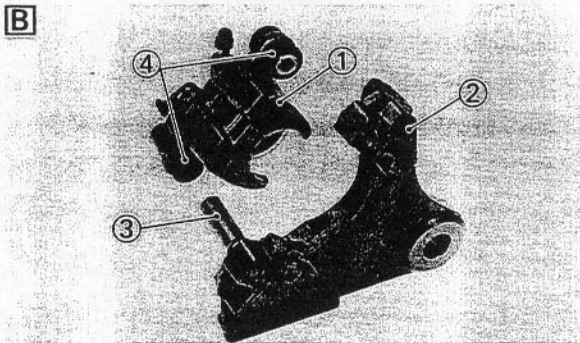
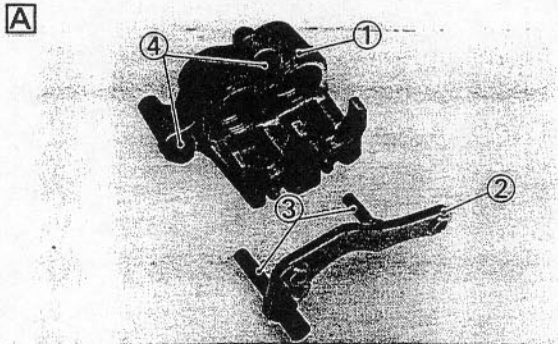

### 2. Inspect:

- Caliper body ①  
Cracks/Damage → Replace.
- Caliper bracket ②  
Cracks/Damage → Replace.
- Guide pin ③  
Rust/Damage → Replace caliper bracket.
- Rubber boots ④  
Cracks/Wear/Damage → Replace.
- Oil delivery passage (caliper body)  
Blow out with compressed air.

- A** Front  
**B** Rear

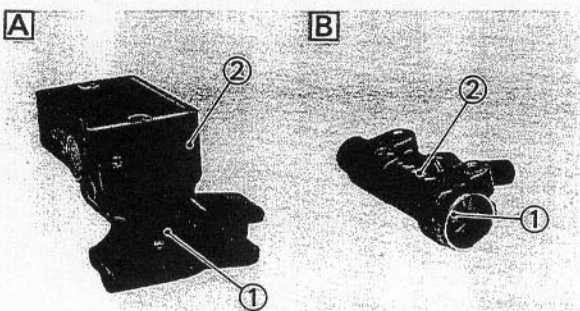

### 3. Inspect:

- Master cylinder ①  
Wear/Scratches → Replace master cylinder assembly.
- Master cylinder body ②  
Cracks/Damage → Replace.
- Oil delivery passage (master cylinder body)  
Blow out with compressed air.

- A** Front  
**B** Rear

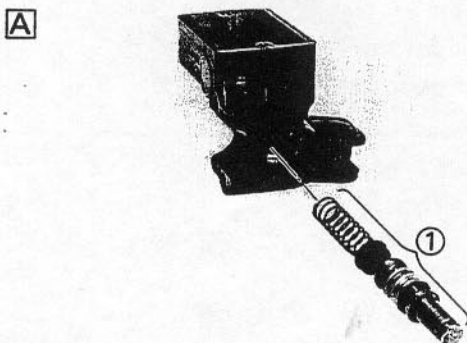

### 4. Inspect:

- Master cylinder kit  
Scratches/Wear/Damage → Replace as a set.

- A** Front brake

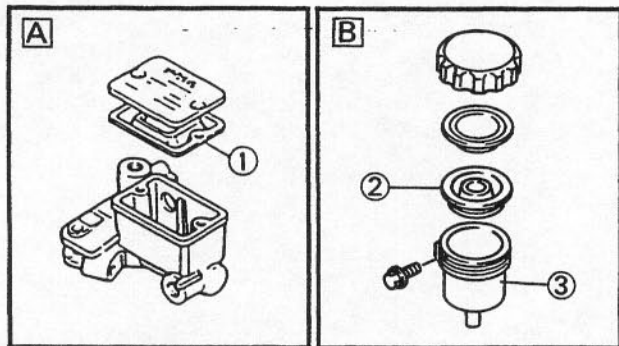
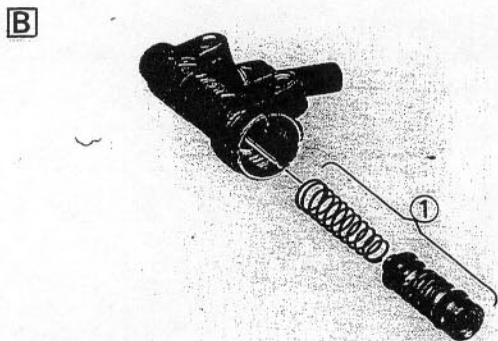

**B** Rear brake

5. Inspect:

- Diaphragm (front) ①
- Diaphragm (rear) ②
- Wear/Damage → Replace.
- Reservoir tank ③
- Cracks/Damage → Replace.

- A** Front
- B** Rear

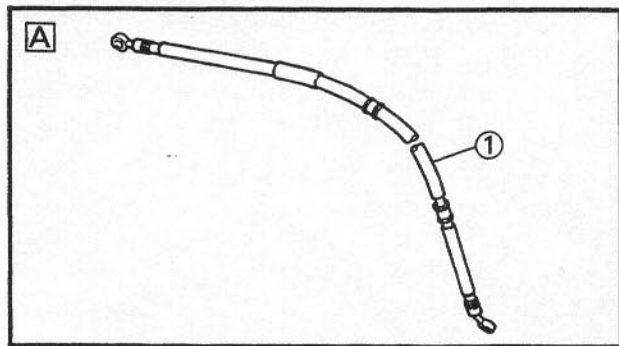

6. Inspect:

- Brake hoses ①
- Reservoir hose ②
- Cracks/Wear/Damage → Replace.

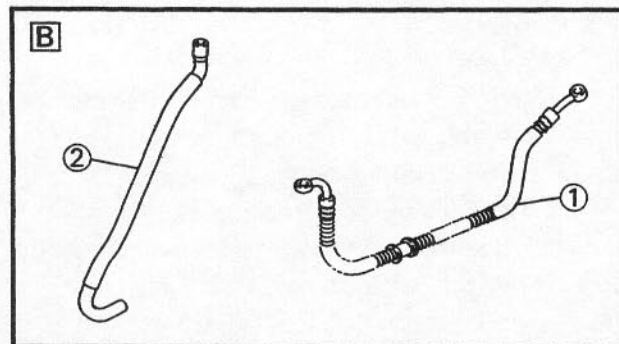

- A** Front
- B** Rear

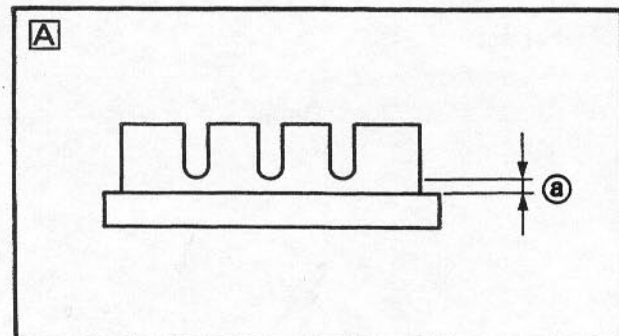

7. Measure:

- Brake pad thickness
- Out of specification → Replace.



**Pad wear limit (a):**

- Front:**
- 1.0 mm (0.04 in)
- Rear:**
- 0.8 mm (0.03 in)

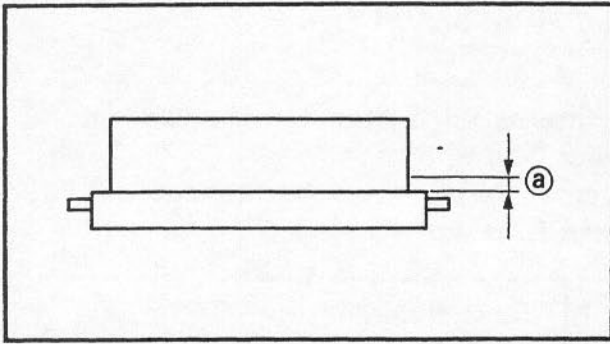

**NOTE:**

Replace the pads as a set if either if found to be worn to the wear limit.

- A** Front
- B** Rear

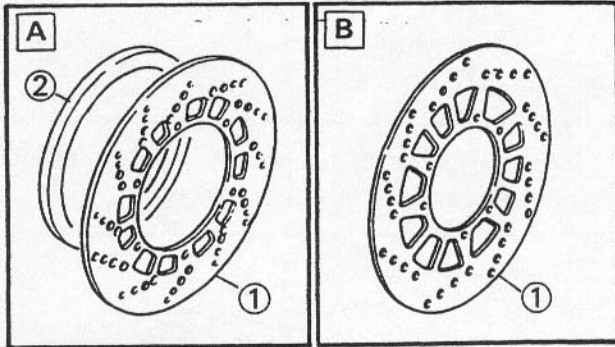

**8. Inspect:**

- Brake discs (front and rear) ①
  - Galling/Damage → Replace.
- Damper rubber ② (front)
  - Cracks/Damage → Replace.

- A** Front
- B** Rear

**9. Measure:**

- Brake disc deflection
  - Out of specification → Inspect wheel runout.
  - If wheel runout is in good condition, replace the brake disc(s).



**Maximum deflection:**  
0.15 mm (0.006 in)

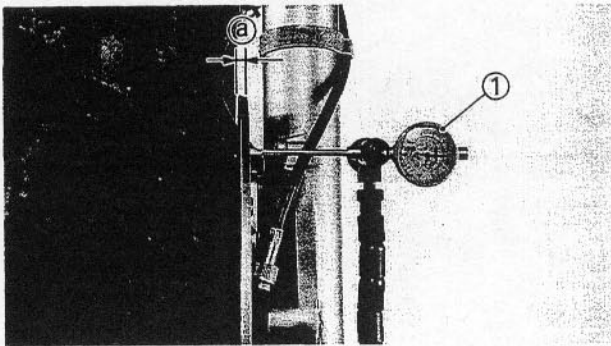

- Brake disc thickness
  - Out of specification → Replace.



**Minimum thickness (a):**  
Front: 4.5 mm (0.18 in)  
Rear: 4.5 mm (0.18 in)

- ① Dial gauge

**NOTE:**

Tighten the bolts (brake disk) in stage using a crisscross pattern.



**Bolt (brake disk):**

**Front:**

20 Nm (2.0 m•kg, 14 ft•lb)

**Rear:**

10 Nm (1.0 m•kg, 7.2 ft•lb)

LOCTITE®.





## CALIPER ASSEMBLY

### ⚠ WARNING

- All internal parts should be cleaned in new brake fluid only.
- Internal parts should be lubricated with brake fluid when installed.



#### Brake fluid:

Front brake:

DOT #4

Rear brake:

DOT #4

- Replace the piston seals and dust seals whenever a caliper is disassembled.

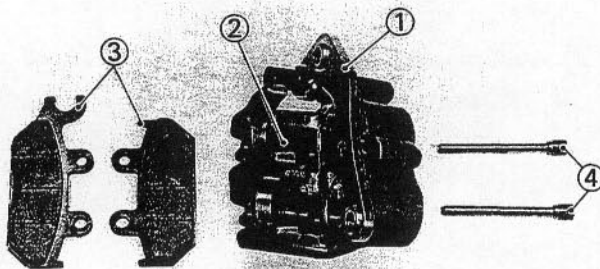
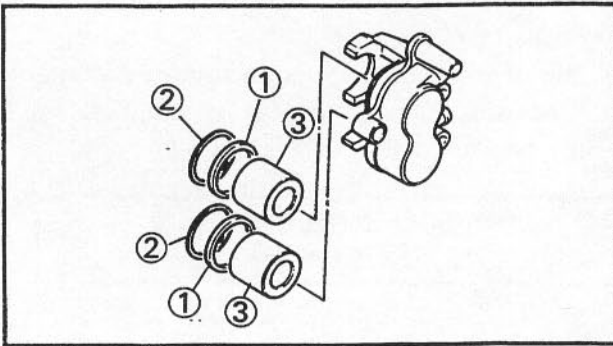

### Front Brake

#### 1. Install:

- Piston seals ①
- Dust seals ②
- Pistons ③

#### 2. Install:

- Caliper bracket ① (to the caliper body)
- Pad spring ②
- Brake pads ③
- Retaining bolts ④

Refer to the "BRAKE PAD REPLACEMENT" section.

#### NOTE:

Place the rubber boot securely in the groove of guide pin when installing the caliper body.

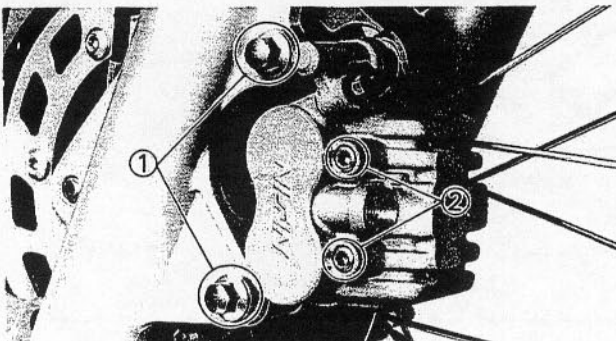

#### 3. Tighten:

- Bolts ① (brake caliper)
- Retaining bolts ②



**Bolt (brake caliper):**

35 Nm (3.5 m•kg, 25 ft•lb)

**Retaining bolt:**

18 Nm (1.8 m•kg, 13 ft•lb)

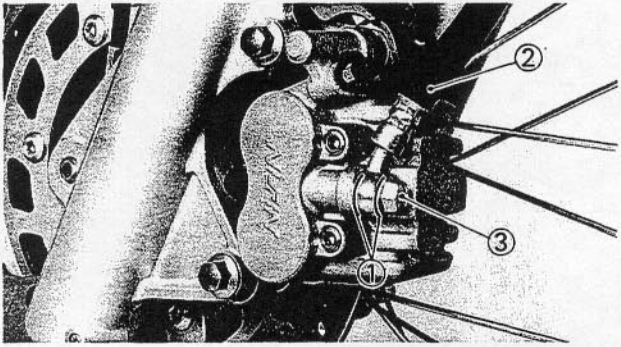

4. Install:
- Copper washers ①
  - Brake hose ②
  - Union bolt ③

 **Union bolt:**  
26 Nm (2.6 m•kg, 19 ft•lb)

**CAUTION:** \_\_\_\_\_

When installing the brake hose, lightly touch the pipe portion (a) of the brake hose with the projection (b) on brake caliper.

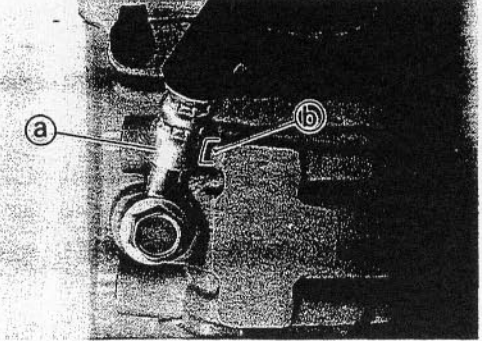

**! WARNING** \_\_\_\_\_

- Proper hose routing is essential to insure safe motorcycle operation. Refer to the "CABLE ROUTING" section in the CHAPTER 2.
- Always use new copper washers.

5. Fill:
- Brake fluid

 **Recommended brake fluid:**  
DOT #4

**CAUTION:** \_\_\_\_\_

Brake fluid may erode painted surfaces or plastic parts. Always clean up spilled fluid immediately.

**! WARNING** \_\_\_\_\_

- Use only the designated quality brake fluid: otherwise, the rubber seals may deteriorate, causing leakage and poor brake performance.
- Refill with the same type of brake fluid; mixing fluids may result in a harmful chemical reaction and lead to poor performance.
- Be careful that water does not enter the master cylinder when refilling. Water will significantly lower the boiling point of the fluid and may result in vapor lock.

6. Air bleed:

- Brake system

Refer to the "AIR BLEEDING" section in the CHAPTER 3.

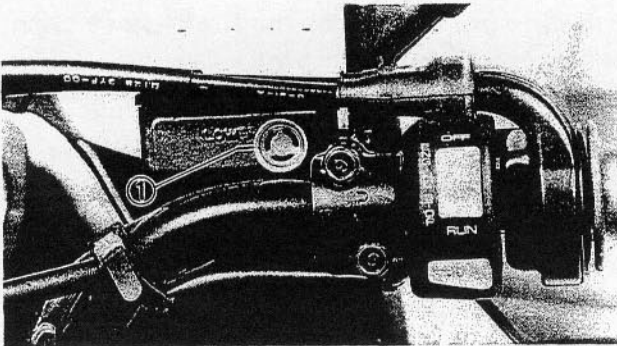

7. Inspect:

- Brake fluid level

Fluid level is under "LOWER" level line ①  
→ Fill up.

Refer to the "BRAKE FLUID INSPECTION" section in the CHAPTER 3.

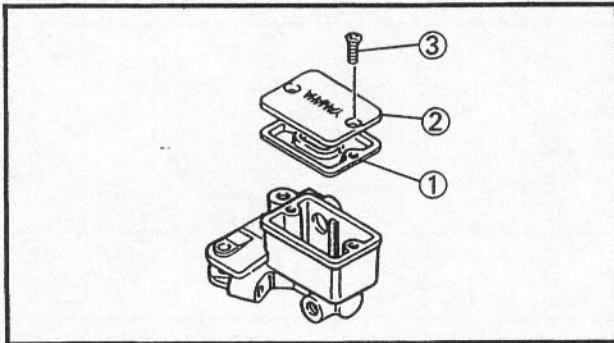

8. Install:

- Diaphragm ①
- Master cylinder cap ②
- Screws ③

 **Screw (master cylinder cap):**  
2 Nm (0.2 m•kg, 1.4 ft•lb)

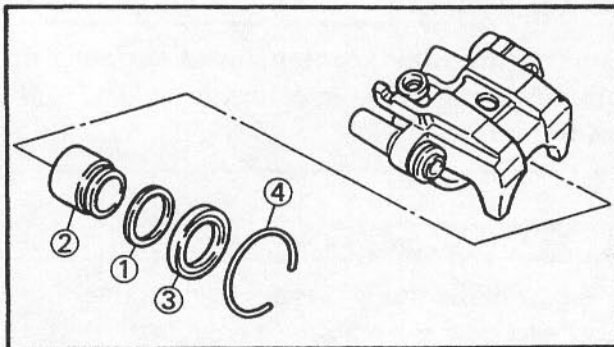

Rear Brake

1. Install:

- Piston seal ①
- Piston ②
- Rubber boot ③
- Ring ④ (rubber boot)

**NOTE:**

First, assemble the piston seal, then assemble the piston.

Stop when this is about half finished and attach the dust boot. Then, while moving the piston into position, attach the rubber boot to the main unit as well. Attach the ring (dust boot) last.



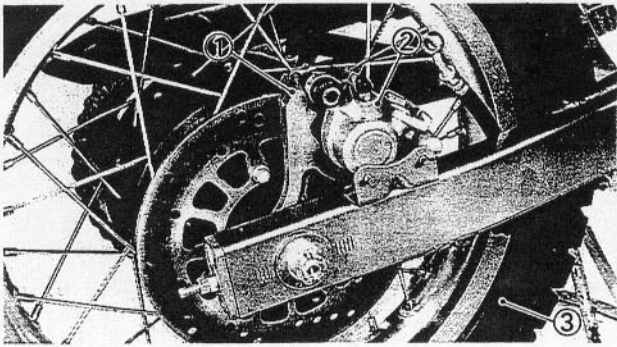

## 2. Install:

- Caliper bracket ①
- Caliper body ②
- Rear wheel ③

Refer to the "REAR WHEEL INSTALLATION" section.

**Axle nut:**

**100 Nm (10.0 m•kg, 72 ft•lb)**

**Lock nut (chain puller):**

**15 Nm (1.5 m•kg, 11 ft•lb)**

**⚠ WARNING**

Always use a new cotter pin of the rear axle nut.

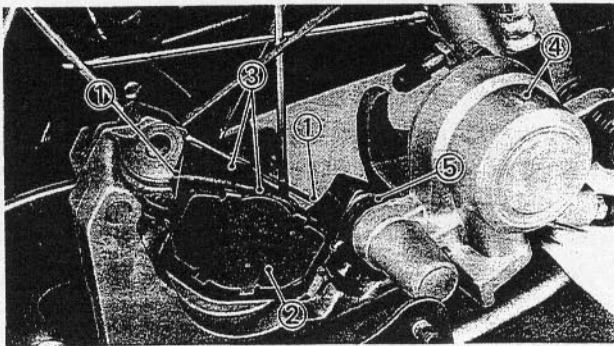

## 3. Install:

- Pad springs ①
- Shim ② (to piston side pad)
- Brake pads ③
- Caliper body ④
- Retaining bolt
- Caliper cover

**Retaining bolt:**

**23 Nm (2.3 m•kg, 17 ft•lb)**

**NOTE:**

Place the rubber boot ⑤ securely in the groove of guide pin when installing the caliper body.

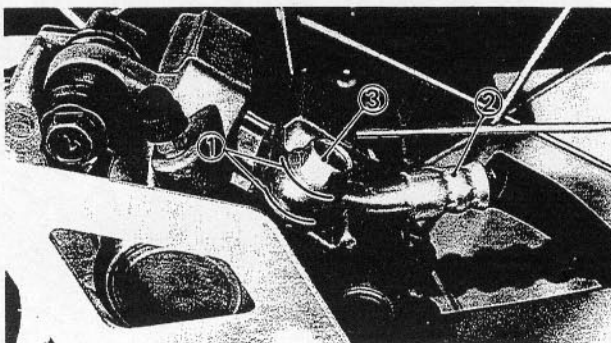

## 4. Install:

- Copper washers ①
- Brake hose ②
- Union bolt ③

**Union bolt:**

**26 Nm (2.6 m•kg, 19 ft•lb)**

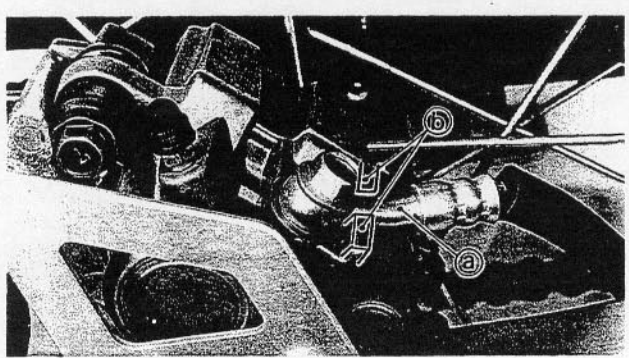

**CAUTION:** \_\_\_\_\_

When installing the brake hose, lightly touch the pipe portion (a) of the brake hose with the projections (b) on brake caliper.

**⚠ WARNING** \_\_\_\_\_

- Proper hose routing is essential to insure safe motorcycle operation. Refer to the "CABLE ROUTING" section in the CHAPTER 2.
- Always use new copper washers.

5. Fill:

- Brake fluid

	Recommended brake fluid: DOT #4
---	------------------------------------

**CAUTION:** \_\_\_\_\_

Brake fluid may erode painted surfaces or plastic parts. Always clean up spilled fluid immediately.

**⚠ WARNING** \_\_\_\_\_

- Use only the designated quality brake fluid: otherwise, the rubber seals may deteriorate, causing leakage and poor brake performance.
- Refill with the same type of brake fluid; mixing fluids may result in a harmful chemical reaction and lead to poor performance.
- Be careful that water does not enter the master cylinder when refilling. Water will significantly lower the boiling point of the fluid and may result in vapor lock.

6. Air bleed:

- Brake system  
Refer to the "AIR BLEEDING" section in the CHAPTER 3.

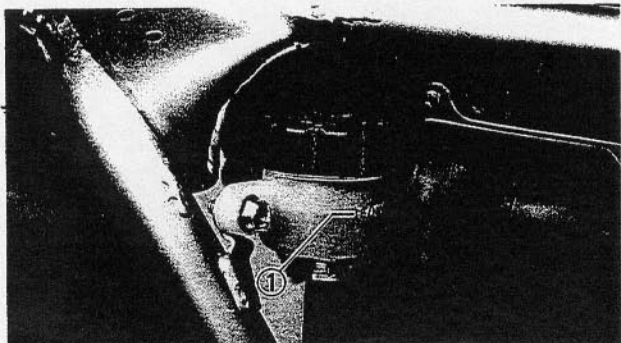

7. Inspect:

- Brake fluid level  
Fluid level is under "LOWER" level line ①  
→ Fill up.  
Refer to the "BRAKE FLUID INSPECTION" section in the CHAPTER 3.

MASTER CYLINDER ASSEMBLY

**⚠ WARNING**

- All internal parts should be cleaned in new brake fluid only.
- Internal parts should be lubricated with brake fluid when installed.



**Brake fluid:**  
**Front brake:**  
 DOT #4  
**Rear brake:**  
 DOT #4

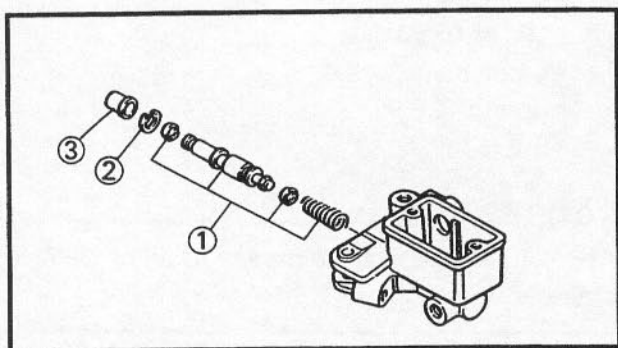

Front Brake

1. Install:

- Master cylinder kit ①
- Circlip ②
- Dust boot ③

2. Install:

- Master cylinder ①

NOTE:

- Install the master cylinder bracket with the "UP" mark facing upward.
- Tighten first the upper bolt then the lower bolt.



**Bolt (master cylinder bracket):**  
 7 Nm (0.7 m•kg, 5.1 ft•lb)

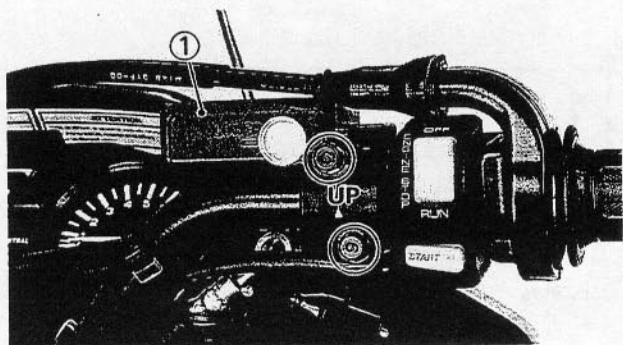



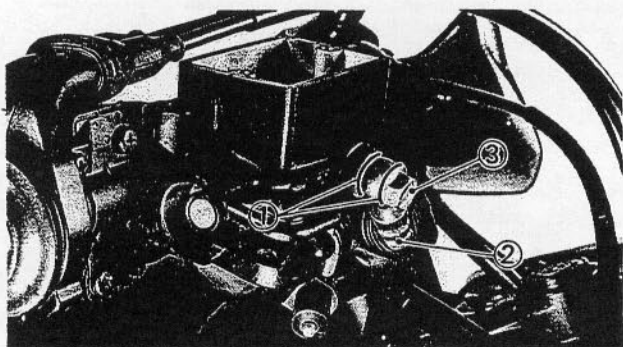

3. Install:
- Copper washers ①
  - Brake hose ②
  - Union bolt ③



**Union bolt:**  
26 Nm (2.6 m•kg, 19 ft•lb)

**NOTE:** \_\_\_\_\_  
Install the brake hose as shown.

**⚠ WARNING** \_\_\_\_\_

- Proper hose routing is essential to insure safe motorcycle operation. Refer to the "CABLE ROUTING" section in the CHAPTER 2.
- Always use new copper washers.

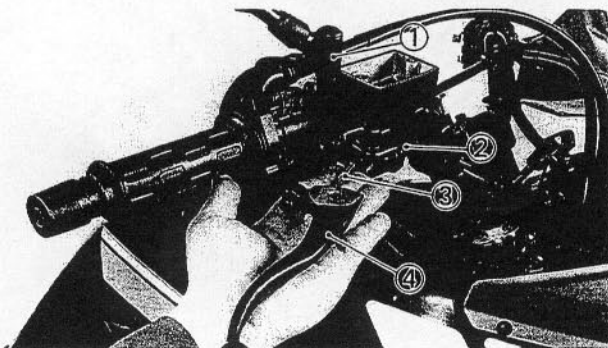
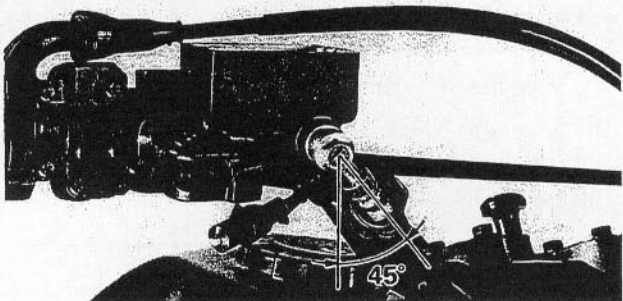

4. Install:
- Mirror (right) ①
  - Brake switch ②
  - Spring ③
  - Brake lever ④
  - Guard

**NOTE:** \_\_\_\_\_  
Apply lithium soap base grease to pivot shaft of brake lever.

5. Fill:
- Brake fluid



**Recommended brake fluid:**  
DOT #4

**CAUTION:** \_\_\_\_\_

Brake fluid may erode painted surfaces or plastic parts. Always clean up spilled fluid immediately.

**⚠ WARNING**

- Use only the designated quality brake fluid: otherwise, the rubber seals may deteriorate, causing leakage and poor brake performance.
- Refill with the same type of brake fluid; mixing fluids may result in a harmful chemical reaction and lead to poor performance.
- Be careful that water does not enter the master cylinder when refilling. Water will significantly lower the boiling point of the fluid and may result in vapor lock.

6. Air bleed:

- Brake system  
Refer to the "AIR BLEEDING" section in the CHAPTER 3.

7. Inspect:

- Brake fluid level  
Fluid level is under "LOWER" level line ① → Fill up.  
Refer to the "BRAKE FLUID INSPECTION" section in the CHAPTER 3.

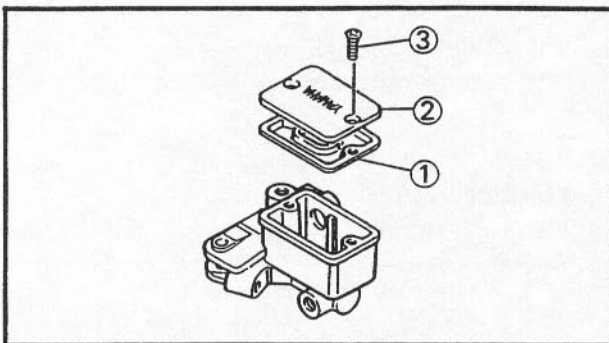
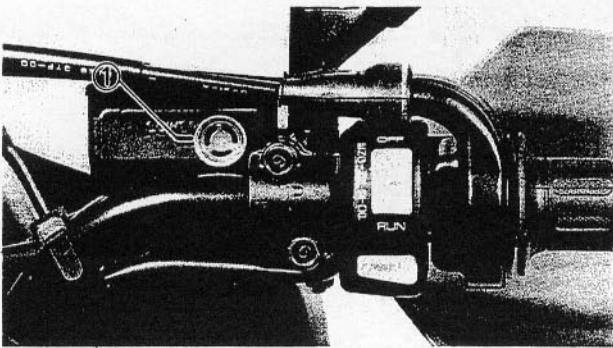

8. Install:

- Diaphragm ①
- Master cylinder cap ②
- Screws ③

 Screw (master cylinder cap):  
2 Nm (0.2 m•kg, 1.4 ft•lb)

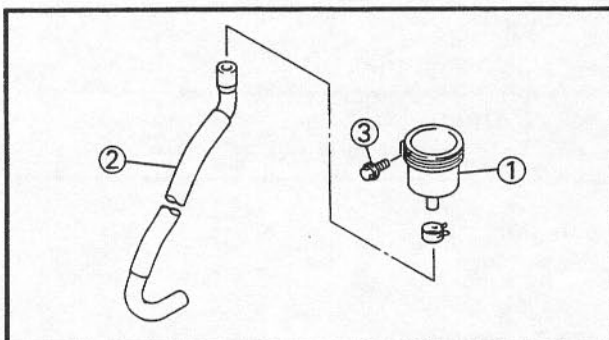

Rear Brake

1. Install:

- Reservoir tank ①

 Screw ③ (reservoir tank):  
4 Nm (0.4 m•kg, 2.9 ft•lb)

2. Connect:

- Reservoir tank hose ② (to reservoir tank)

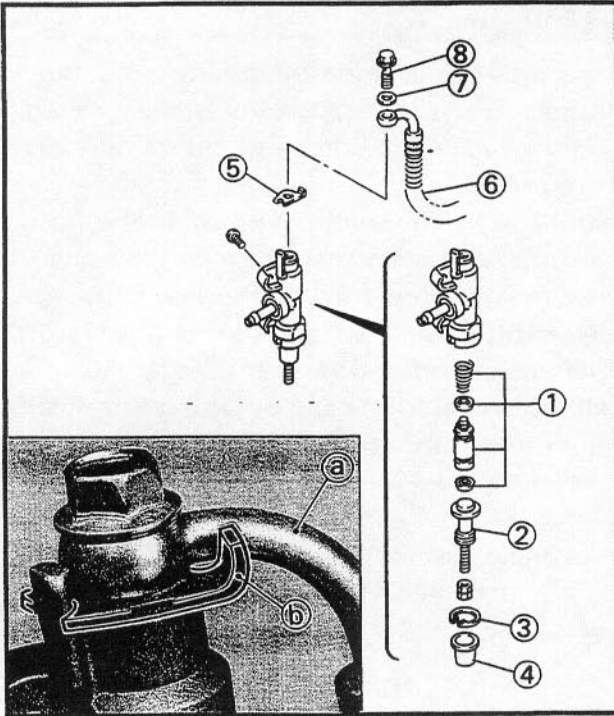

3. Install:
  - Master cylinder kit ①
  - Adjusting rod ②
  - Circlip ③
  - Dust boot ④
4. Install:
  - Lock washer ⑤
  - Brake hose ⑥
  - Copper washer ⑦
  - Union bolt ⑧  
(temporarily tighten)

**CAUTION:** \_\_\_\_\_

When installing the brake hose, lightly touch the pipe portion (a) of the brake hose with the projection (b) on the lock washer (5).

**! WARNING** \_\_\_\_\_

- Proper hose routing is essential to insure safe motorcycle operation. Refer to the "CABLE ROUTING" section in the CHAPTER 2.
- Always use new copper washers.

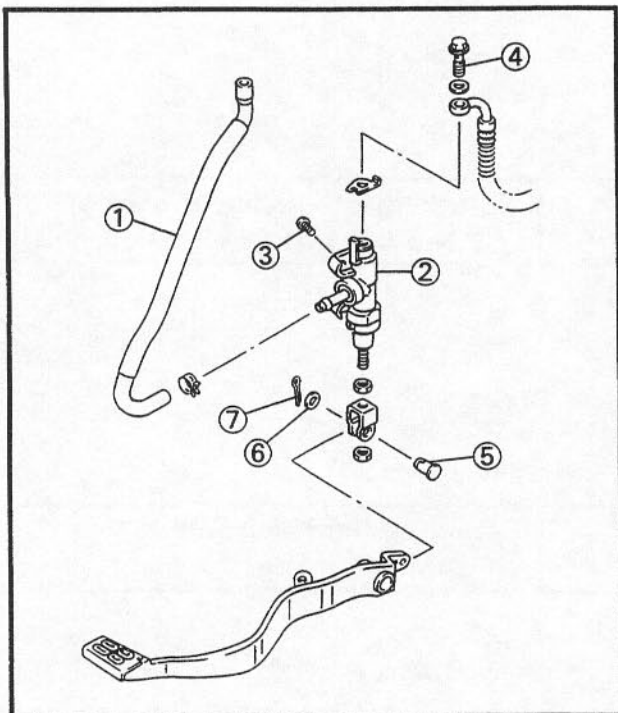

5. Connect:
  - Reservoir hose ①  
(to master cylinder)
6. Install:
  - Master cylinder ②
  - Bolt ③ (master cylinder)

 **Bolt (master cylinder):**  
20 Nm (2.0 m•kg, 14 ft•lb)

7. Tighten:
  - Union bolt ④

 **Union bolt:**  
26 Nm (2.6 m•kg, 19 ft•lb)

8. Install:
  - Pin ⑤
  - Plain washer ⑥
  - Cotter pin ⑦



**⚠ WARNING**

Always use a new cotter pin.

## 9. Fill:

- Brake fluid



Recommended brake fluid:  
DOT #4

**CAUTION:**

Brake fluid may erode painted surfaces or plastic parts. Always clean up spilled fluid immediately.

**⚠ WARNING**

- Use only the designated quality brake fluid; otherwise, the rubber seals may deteriorate, causing leakage and poor brake performance.
- Refill with the same type of brake fluid; mixing fluid may result in a harmful chemical reaction and lead to poor performance.
- Be careful that water does not enter the master cylinder when refilling. Water will significantly lower the boiling point of the fluid and may result in vapor lock.

## 10. Air bleed:

- Brake system  
Refer to the "AIR BLEEDING" section in the CHAPTER 3.

## 11. Inspect:

- Brake fluid level  
Fluid level is under "LOWER" level line ①  
→ Fill up.  
Refer to the "BRAKE FLUID INSPECTION" section in the CHAPTER 3.

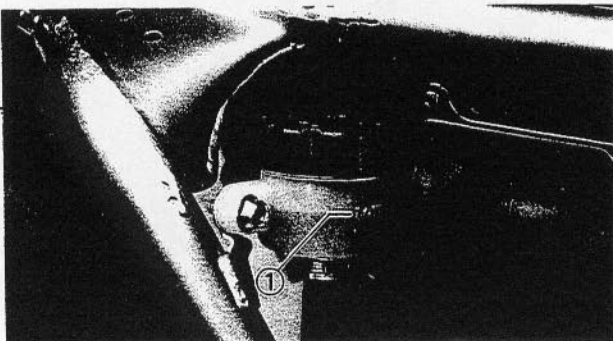

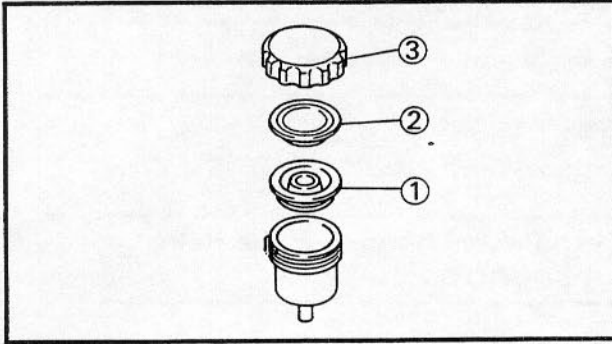

12. Install:

- Diaphragm ①
- Bush (diaphragm) ②
- Cap ③

13. Install:

- Side cover (right)
- Seat

	<b>Bolt (side cover):</b>
	<b>7 Nm (0.7 m•kg, 5.1 ft•lb)</b>
	<b>Bolt (seat):</b>
	<b>10 Nm (1.0 m•kg, 7.2 ft•lb)</b>

**FRONT FORK**

- ① Cap bolt
- ② O-ring
- ③ Spacer
- ④ Spring seat
- ⑤ Fork spring
- ⑥ Inner fork tube
- ⑦ Damper rod
- ⑧ Oil lock piece
- ⑨ Retaining clip
- ⑩ Dust seal
- ⑪ Oil seal
- ⑫ Washer
- ⑬ Guide bush
- ⑭ Outer fork tube
- ⑮ Axle holder
- ⑯ Fork boot
- ⑰ Cable band (speedometer cable)

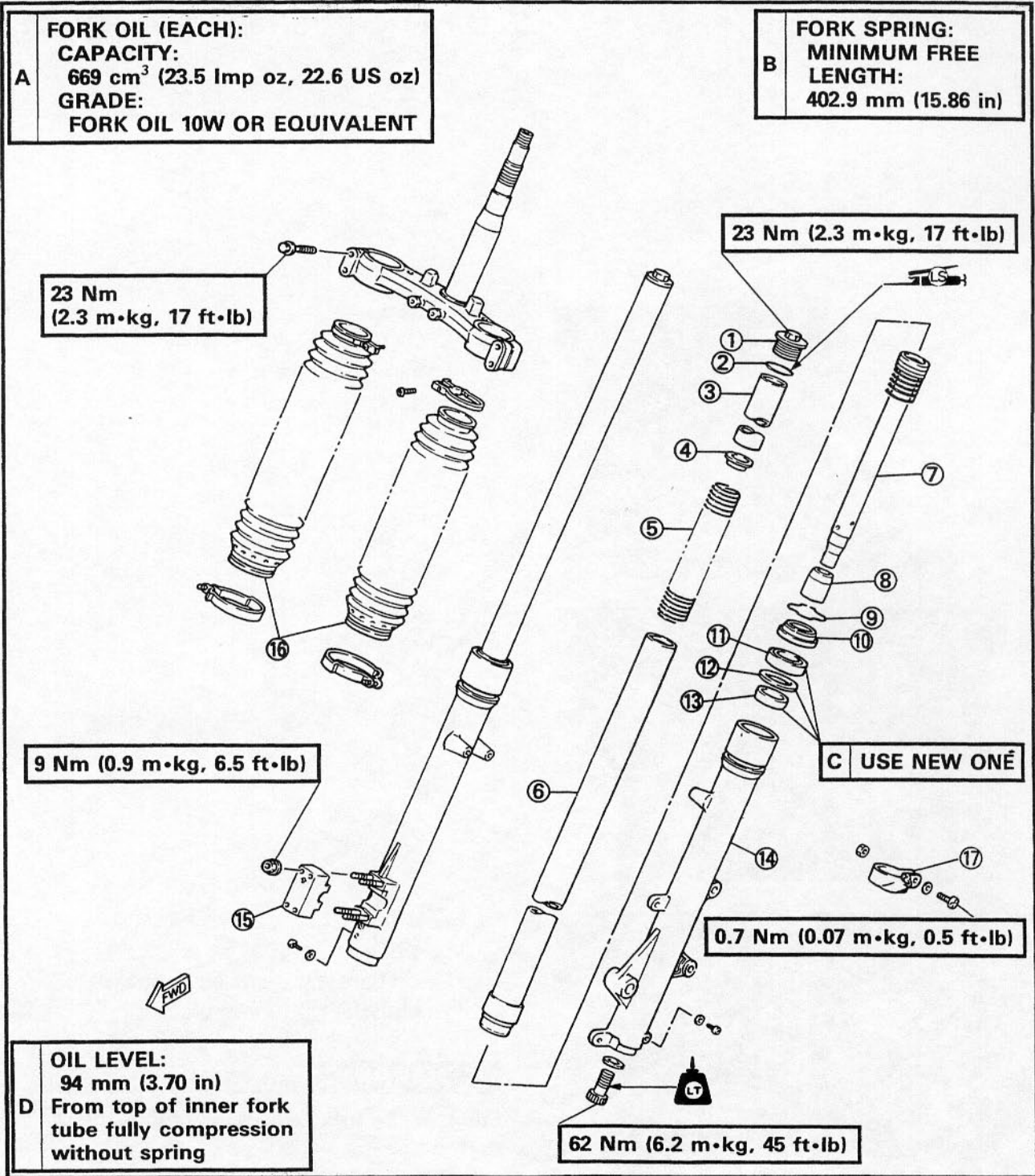





## REMOVAL

**⚠ WARNING**

Support the motorcycle securely so there is no danger of it falling over.

1. Place the motorcycle on a level place.
2. Elevate the front wheel by placing a suitable stand under the frame and engine.
3. Remove:
  - Front wheel
 Refer to the "FRONT WHEEL—REMOVAL" section.

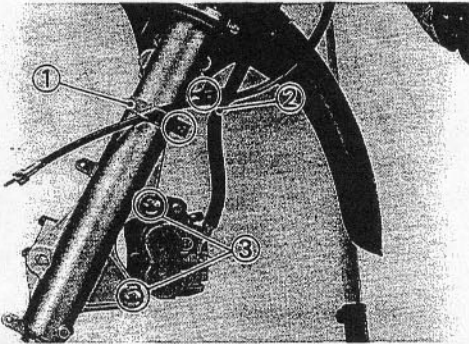

4. Remove:
  - Cable band ① (speedometer cable)
  - Holder ② (brake hose)
  - Bolt ③ (brake caliper)

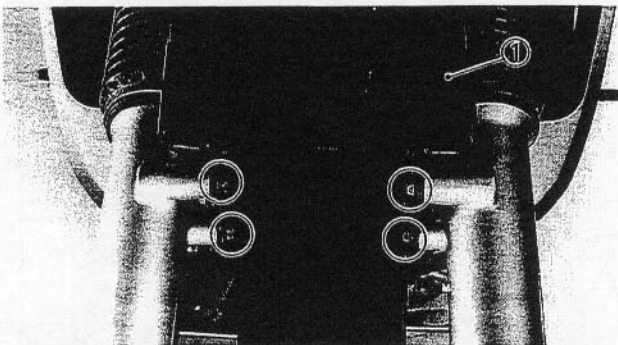

5. Remove:
  - Front fender ①

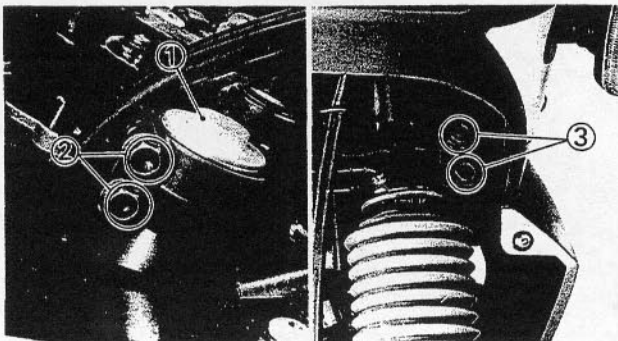

6. Loosen:
  - Cap bolt ①
  - Pinch bolts ② (handlebar crown)
  - Pinch bolts ③ (under bracket)

**⚠ WARNING**

Support the fork before loosening the pinch bolt.

7. Remove:  
 •Front fork ①

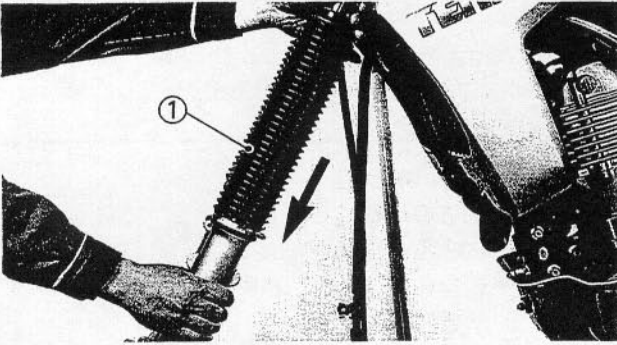

**DISASSEMBLY**

1. Remove:  
 •Fork boot ①

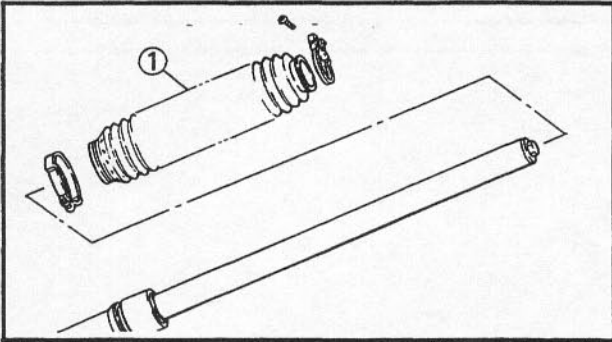

2. Remove:  
 •Cap bolt ①  
 •Spacer ②  
 •Spring seat ③  
 •Fork spring ④

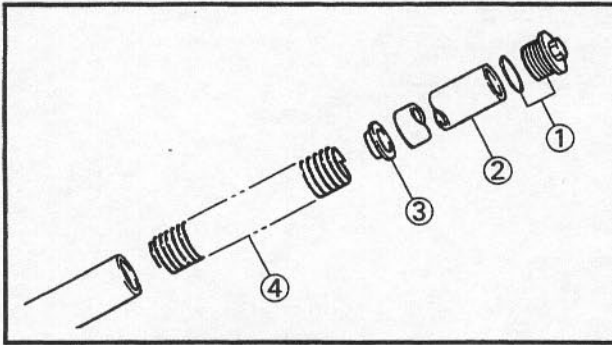

3. Drain:  
 •Fork oil
4. Remove:  
 •Retaining clip ①

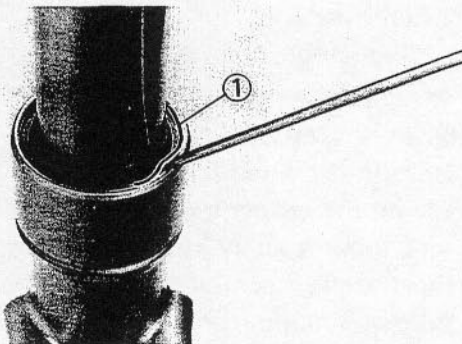

**NOTE:** \_\_\_\_\_  
 Use a thin screwdriver, and be careful not to scratch the inner fork tube.

5. Remove:  
 •Bolt ① (damper rod)  
 •Washer ②

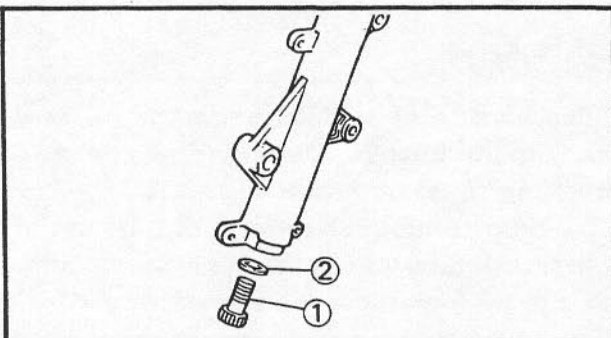

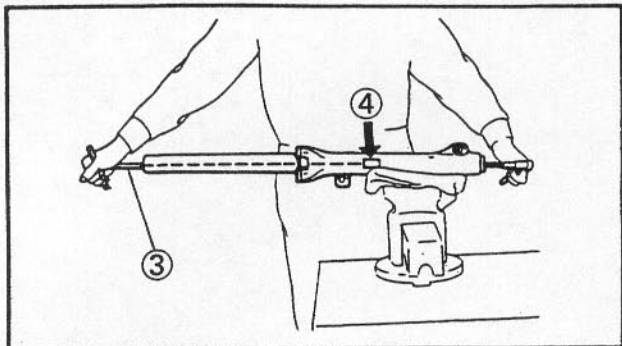

**NOTE:**  
Hold the damper rod to loosen the bolt (damper rod) by the T-handle (3) and holder (4).



**T-handle:**  
YM-01326  
90890-01326  
**Holder 30 mm (1.18 in):**  
YM-01327  
90890-01327

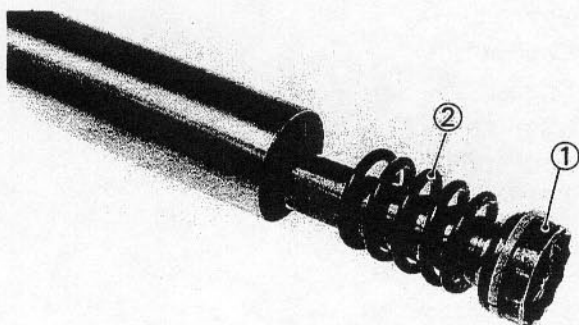

6. Remove:
- Damper rod (1)
  - Rebound spring (2)

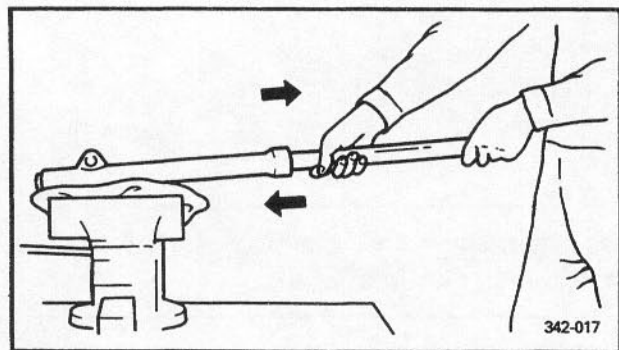

7. Remove:
- Inner fork tube

\*\*\*\*\*

**Removal steps:**

- Hold the fork leg horizontally.
- Clamp the caliper mounting boss of the outer fork tube securely in a vise with soft jaws.
- Pull out the inner fork tube from the outer fork tube by forcefully, but carefully, with drawing the inner fork tube.

**CAUTION:**

- Excessive force will damage the oil seal and/or the bushes. Damaged oil seal and bushing must be replaced.
- Avoid bottoming the inner fork tube in the outer fork tube during the above procedure, as the oil lock piece will be damaged.

\*\*\*\*\*





## 8. Remove:

- Dust seal ①
- Oil seal ②
- Washer ③
- Guide bush ④
- Oil lock pieces ⑤

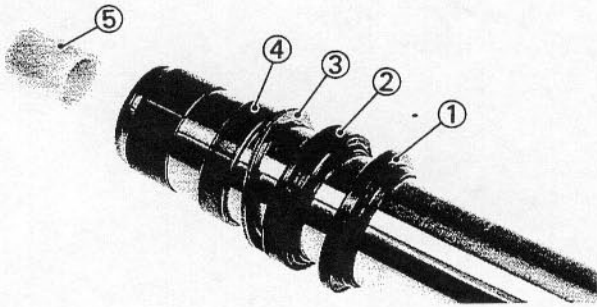

## INSPECTION

## 1. Inspect:

- Inner fork tube ①
  - Outer fork tube ②
- Scratches/Bends/Damage → Replace.

**⚠ WARNING**

Do not attempt to straighten a bent inner fork tube as this may dangerously weaken the tube.

## 2. Measure:

- Fork spring free length (a)
- Out of specification → Replace.

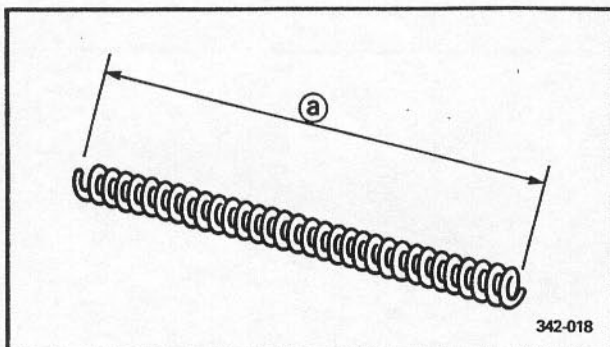

Fork spring free length:  
407.0 mm (16.02 in)  
Minimum free length:  
402.9 mm (15.86 in)

## 3. Inspect:

- Damper rod ①  
Wear/Damage → Replace.  
Contamination → Blow out all oil passages with compressed air.
- Piston ring ②  
Wear/Damage → Replace.

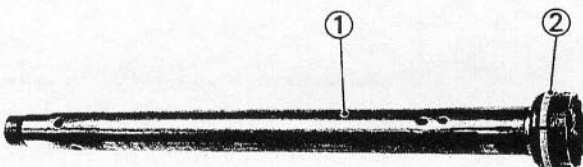

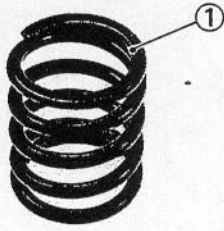

## 4. Inspect:

- Rebound spring ①
- Wear/Damage → Replace.

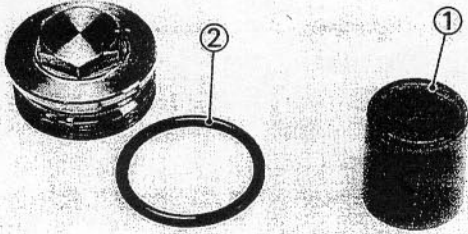

## 5. Inspect:

- Oil lock piece ①
  - O-ring ② (cap bolt)
- Damage → Replace.

**ASSEMBLY**

Reverse the "DISASSEMBLY" procedure. Note the following points.

**NOTE:**

- In front fork reassembly, be sure to use following new parts.
  - \* Guide bush
  - \* Oil seal
  - \* Dust seal
- Make sure all components are clean before reassembly.

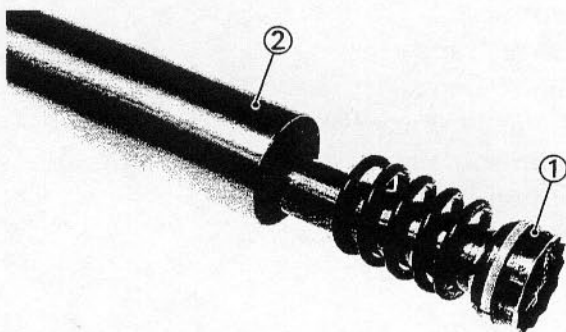

## 1. Install:

- Damper rod ①

**CAUTION:**

Allow the damper rod to slide slowly down the inner fork tube ② until it protrudes from the bottom, being careful not to damage the inner fork tube.

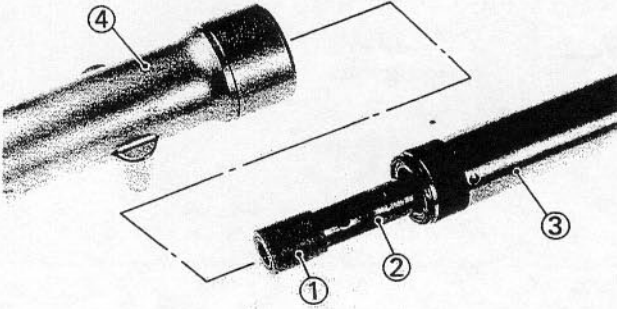

2. Install:
  - Oil lock piece ① (to damper rod ②)
3. Lubricate:
  - Inner fork tube (outer surface) ③



**Fork oil 10W or equivalent**

4. Install:
  - Inner fork tube (to outer fork tube ④)

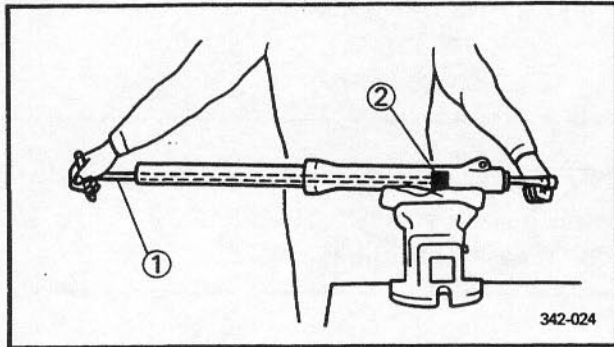

5. Tighten:
  - Bolt (damper rod)  
Use the T-handle ① and holder ② to lock the damper rod.



**T-handle:**  
YM-01326  
90890-01326

**Holder**  
30 mm (1.18 in):  
YM-01327  
90890-01327



**Bolt (damper rod):**  
62 Nm (6.2 m•kg, 45 ft•lb)  
LOCTITE®.

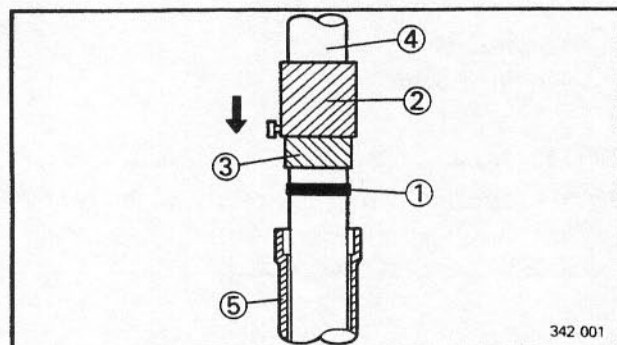

6. Install:
  - Guide bush ①  
Use the fork seal driver weight ② and adapter ③.

- ④ Inner fork tube
- ⑤ Outer fork tube





Fork seal driver weight:

YM-33963  
90890-01367

Adapter

43 mm (1.69 in):  
YM-08020  
90890-01374

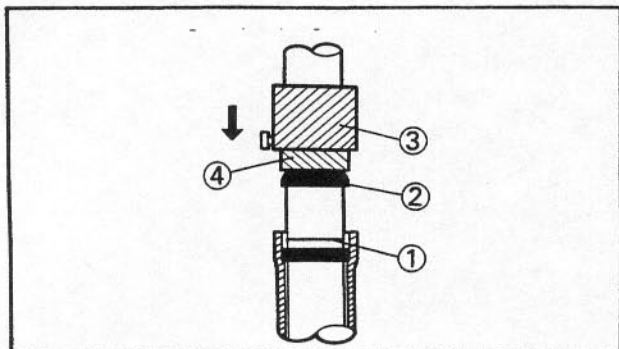

7. Install:

- Washer ①
- Oil seal ②

Use the fork seal driver weight ③ and adapter ④.



Fork seal driver weight:

YM-33963  
90890-01367

Adapter

43 mm (1.69 in):  
YM-08020  
90890-01374

**NOTE:** \_\_\_\_\_

Before installing the oil seal, apply the lithium soap base grease onto the oil seal lips.

**CAUTION:** \_\_\_\_\_

Be sure that the oil seal numbered side face upward.

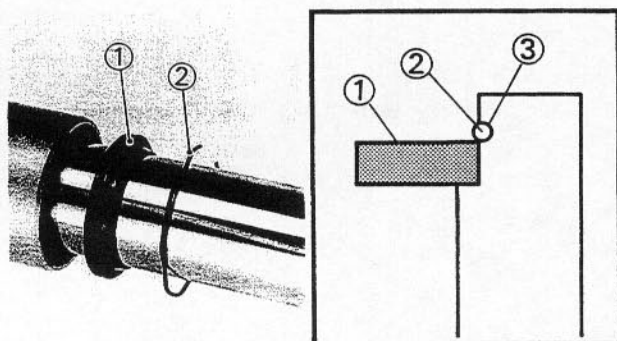

8. Install:

- Dust seal ①
- Retaining clip ②

**NOTE:** \_\_\_\_\_

Fit the retaining clip ② correctly in the groove ③ in the outer fork tube.



9. Fill:

- Front fork



Each fork:

669 cm<sup>3</sup> (23.5 Imp oz, 22.6 US oz)

Fork oil 10W or equivalent

After filling, slowly pump the fork up and down to distribute oil.

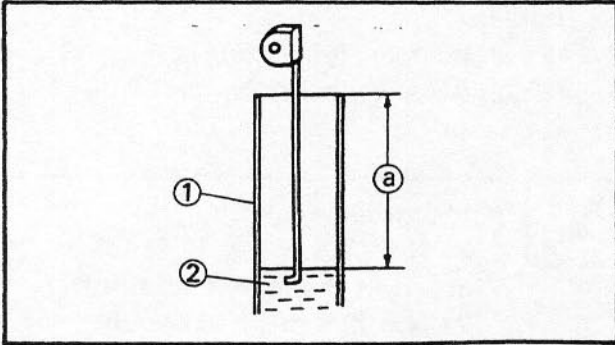

Oil level (a):

94 mm (3.70 in)

From the top of inner fork tube fully compressed without spring.

- ① Inner fork tube
- ② Fork oil

10. Install:

- Fork spring ①
- Spring seat ②
- Spacer collar ③
- O-ring ④
- Cap bolt ⑤

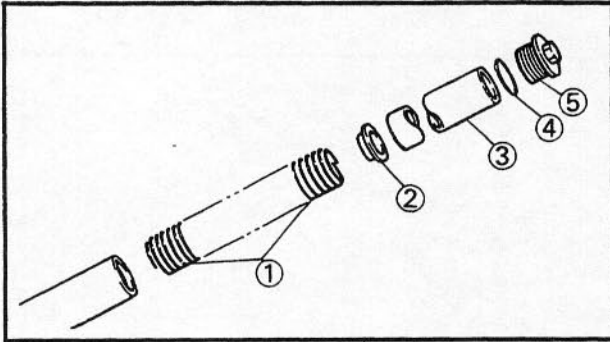

NOTE:

- Before installing the cap bolt, apply the grease to the O-ring ④.
- Temporarily tighten the cap bolt ⑤.

INSTALLATION

Reverse the "REMOVAL" procedure.  
Note the following points.

1. Install:

- Front fork
- Temporary tighten the pinch bolts.

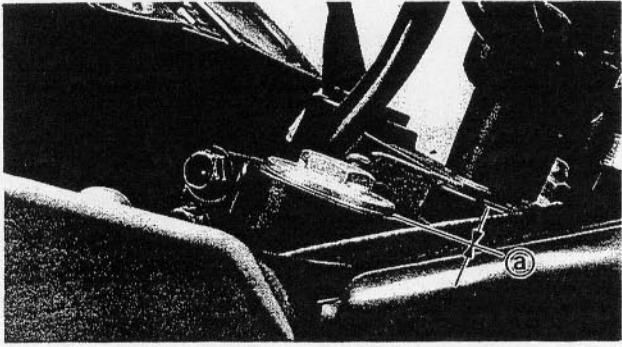

**NOTE:**  
Position the inner fork tube end in such a way that it is flush (a) with the top of the handle crown.

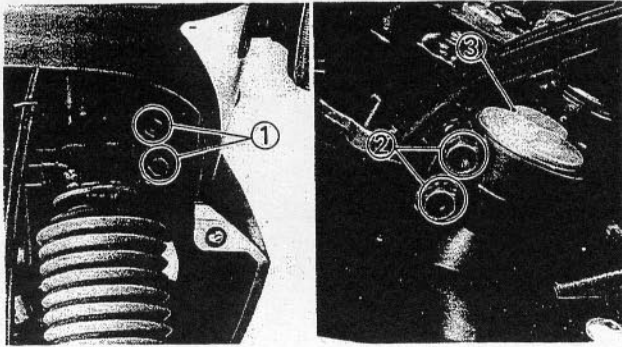

2. Tighten:
- Pinch bolts ① (under bracket)
  - Pinch bolts ② (handlebar crown)
  - Cap bolt ③

	<b>Nut (under bracket):</b>
	23 Nm (2.3 m•kg, 17 ft•lb)
	<b>Pinch bolt (handlebar crown):</b>
	23 Nm (2.3 m•kg, 17 ft•lb)
	<b>Cap bolt:</b>
	23 Nm (2.3 m•kg, 17 ft•lb)

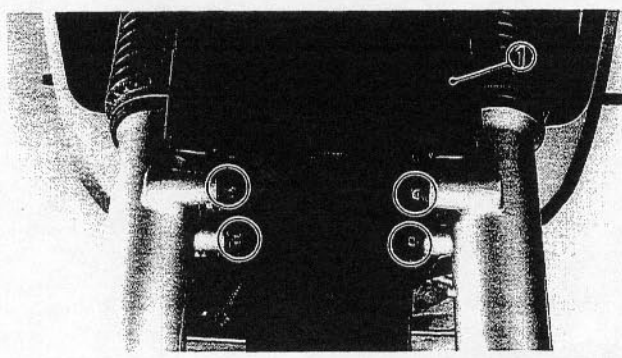

3. Install:
- Front fender ①

	<b>Bolt (front fender):</b>
	8 Nm (0.8 m•kg, 5.8 ft•lb)

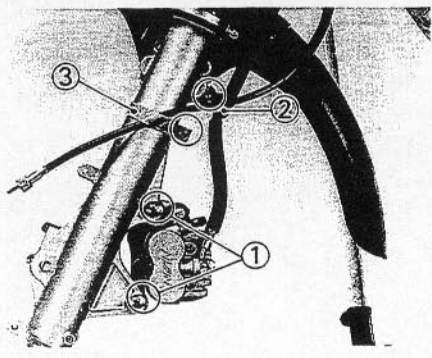

4. Install:
- Brake caliper ①
  - Holder ② (brake hose)
  - Cable band ③ (speedometer cable)

	<b>Bolt (brake caliper):</b>
	35 Nm (3.5 m•kg, 25 ft•lb)
	<b>Bolt (brake hose holder):</b>
	7 Nm (0.7 m•kg, 5.1 ft•lb)
	<b>Bolt (speedometer cable):</b>
	0.7 Nm (0.07 m•kg, 0.5 ft•lb)



**⚠ WARNING**

Proper hose routing is essential to insure safe motorcycle operation. Refer to the "CABLE ROUTING" section in the CHAPTER 2.

5. Install:

- Front wheel



**Wheel axle:**

**58 Nm (5.8 m•kg, 42 ft•lb)**

**Nut (axle holder):**

**9 Nm (0.9 m•kg, 6.5 ft•lb)**

Refer to "FRONT WHEEL—INSTALLATION" section.

STEERING HEAD AND HANDLEBAR

- ① Handlebar
- ② Handlebar grip (right)
- ③ Handlebar grip (left)
- ④ Handlebar holder (upper)
- ⑤ Handlebar holder (lower)
- ⑥ Handlebar crown
- ⑦ Stopper washer
- ⑧ Ring nut
- ⑨ Rubber washer
- ⑩ Ring nut
- ⑪ Cover
- ⑫ Bearing (upper)
- ⑬ Bearing (lower)

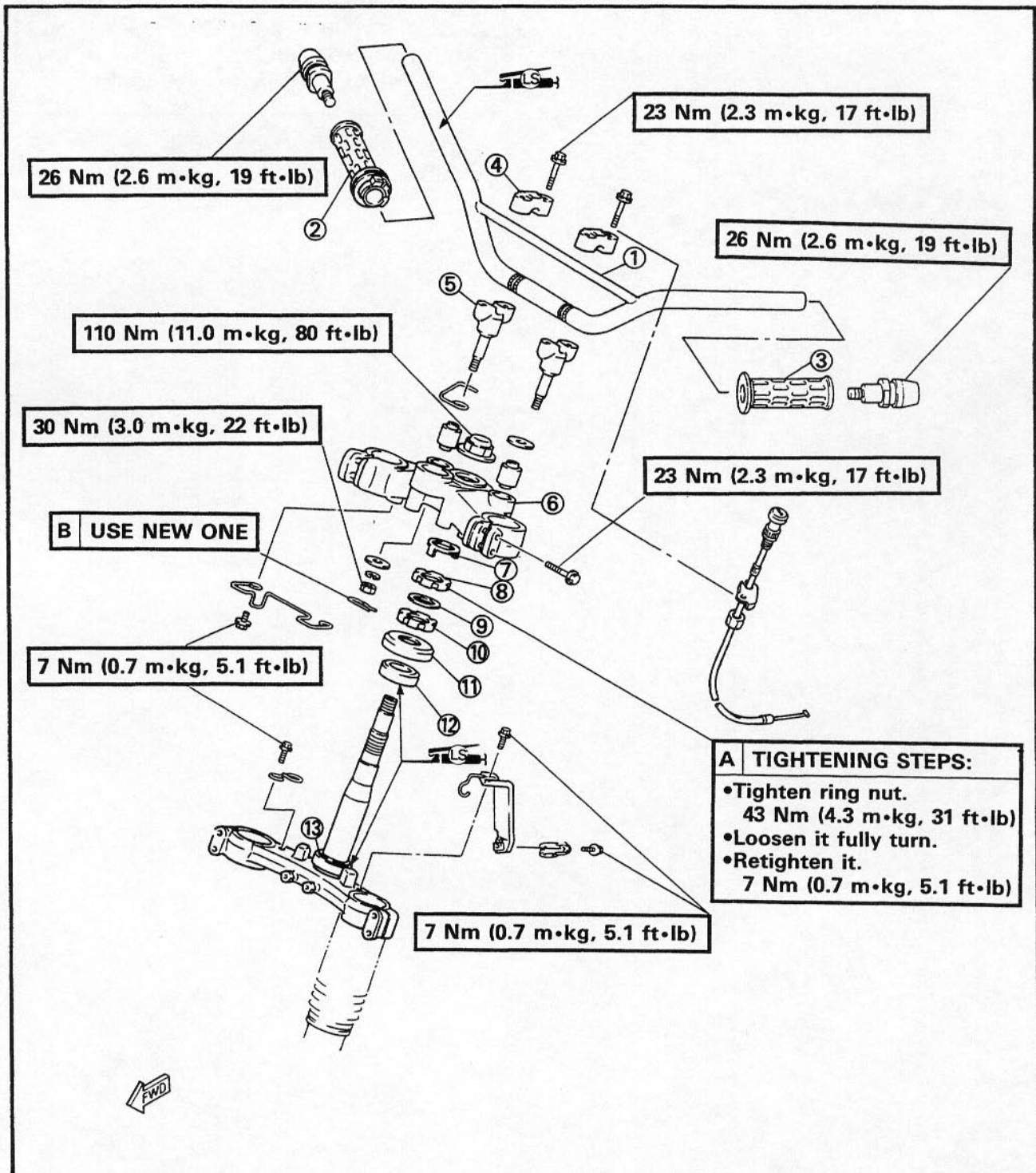



YB375001

**REMOVAL****⚠ WARNING**

Securely support the motorcycle so there is no danger of it falling over.

1. Place the motorcycle on a level place.
2. Remove:
  - Seat
  - Side covers
  - Air scoops
  - Fuel tank
 Refer to the "SEAT, FUEL TANK AND COVER" section in the CHAPTER 3.
3. Elevate the front wheel by placing a suitable stand under the frame and engine.
4. Remove:
  - Front wheel
 Refer to the "FRONT WHEEL—REMOVAL" section.
  - Front fender
  - Front fork
 Refer to the "FRONT FORK—REMOVAL" section.

5. Disconnect:

- Band ①

6. Remove:

- Master cylinder ②

7. Remove:

- Handlebar switch ① (right)

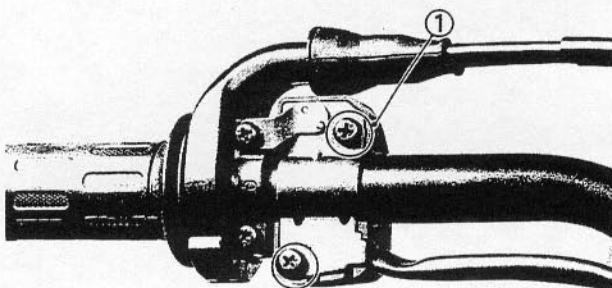
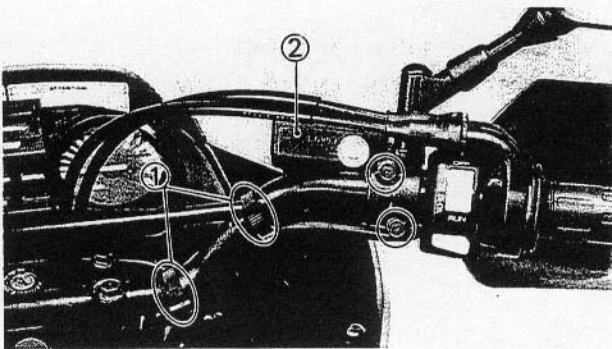



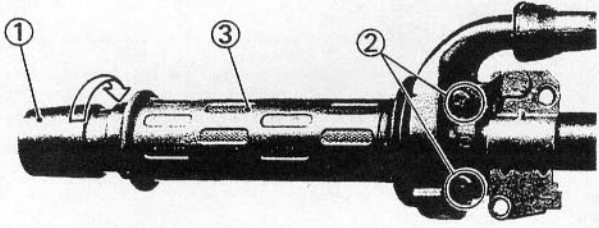

- 8. Remove:
  - Grip end ①
- 9. Loosen:
  - Screw ② (throttle grip)
- 10. Remove:
  - Throttle grip ③

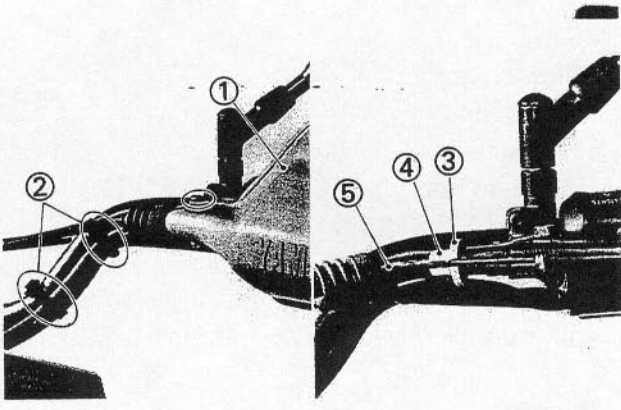

- 11. Remove:
  - Guard ①
- 12. Disconnect:
  - Band ②
- 13. Loosen:
  - Locknut ③ (clutch cable)
  - Adjuster ④ (clutch cable)
- 14. Remove:
  - Clutch cable ⑤

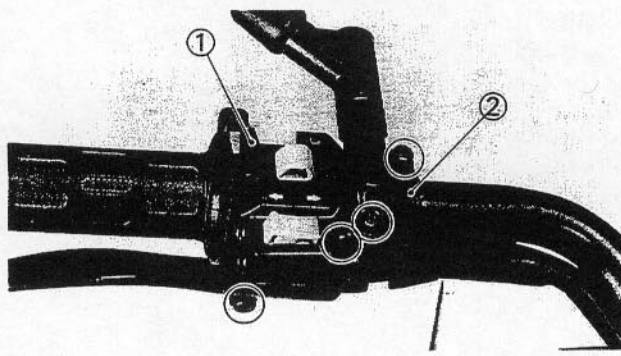

- 15. Remove:
  - Handlebar switch ① (left)
  - Clutch lever holder ②

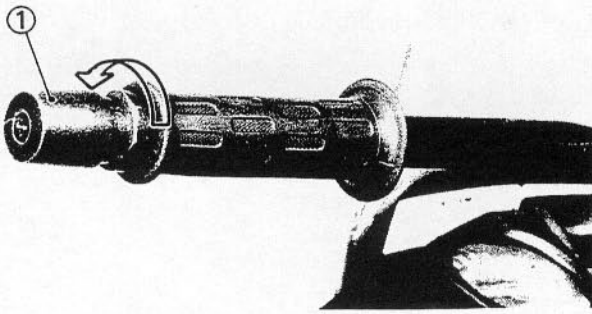

- 16. Remove:
  - Grip end ①

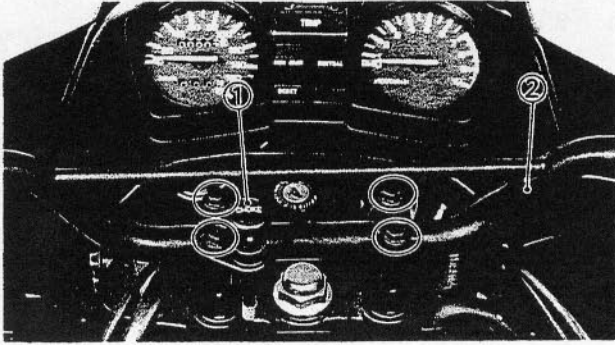

17. Remove:
- "CHOKE" knob ①
  - Handlebar ②

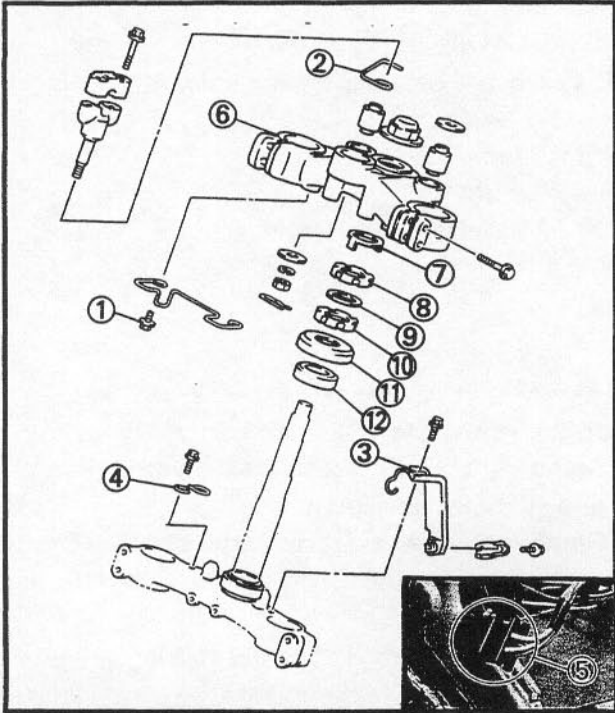

18. Remove:
- Bolt ① (holder)
19. Disconnect:
- Brake hose (from holder ②)
20. Remove:
- Holder (speedometer cable and brake hose) ③
  - Holder ④ (brake hose)
21. Disconnect:
- Main switch lead coupler ⑤
22. Remove:
- Handlebar crown ⑥
  - Stopper washer ⑦
  - Ring nut (upper) ⑧
  - Rubber washer ⑨
  - Ring nut (lower) ⑩
  - Bearing cover ⑪
  - Bearing (upper) ⑫

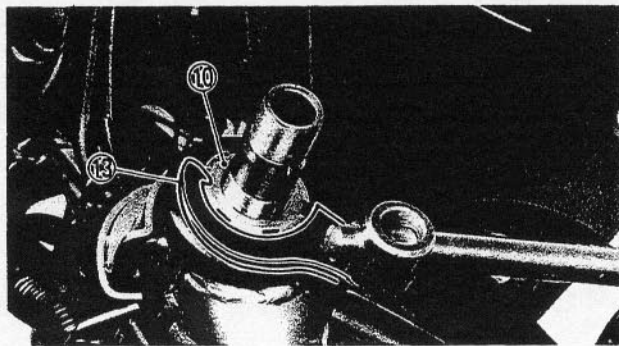

**NOTE:** \_\_\_\_\_  
Remove the ring nut ⑩ by the ring nut wrench ⑬.

	<p><b>Ring nut wrench:</b> P/N. YU-33975, 90890-01403</p>
---	---

**⚠ WARNING** \_\_\_\_\_  
Support the lower bracket so that it may not fall down.

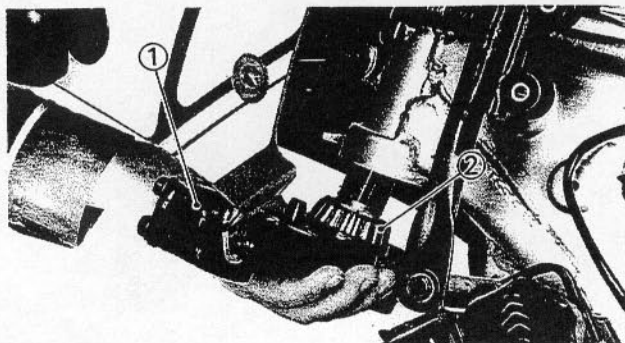

23. Remove:
- Lower bracket ①
  - Bearing ② (lower)

YB275002

**INSPECTION**

1. Wash the bearings with a solvent.
2. Inspect:
  - Bearing ①
  - Pitting/Damage → Replace.

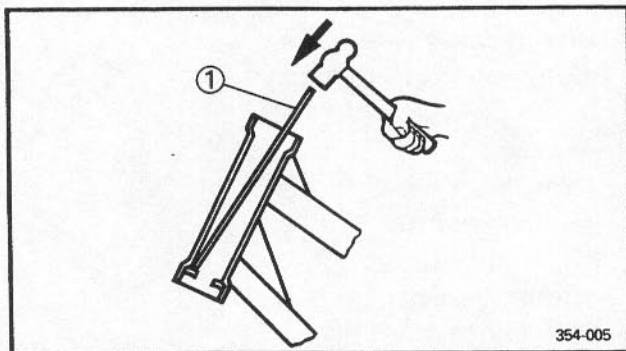
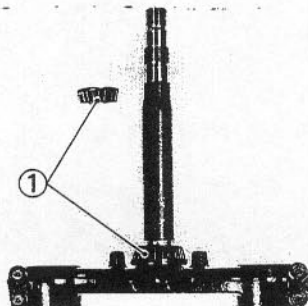

\*\*\*\*\*

**Replacement steps:**

- Remove the bearing races using a long rod ① and hammer as shown.
- Remove the bearing race on the steering stem using the floor chisel ② and the hammer as shown.
- Install the new dust seal and races.

\*\*\*\*\*

**NOTE:** \_\_\_\_\_  
 Always replace bearings, races and dust seal as a set.  
 \_\_\_\_\_

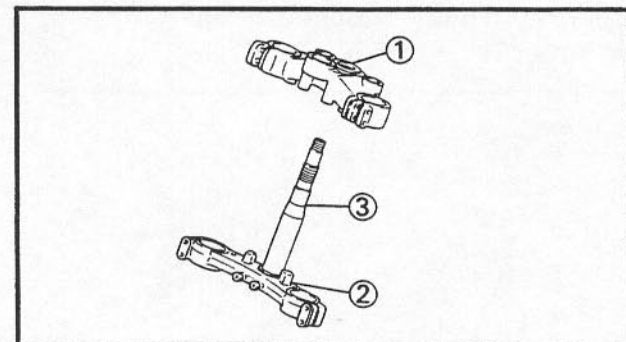
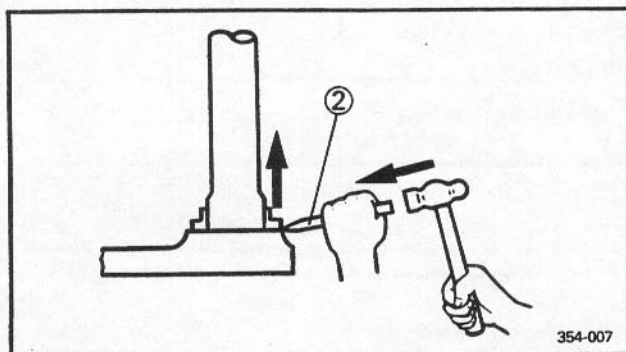

3. Inspect:
  - Handlebar crown ①
  - Lower bracket ②
  - Cracks/Damage → Replace.
  - Steering stem ③
  - Bends/Damage → Replace lower bracket assembly.



**⚠ WARNING**

Do not attempt to straighten a bent steering stem as this may dangerously weaken the steering stem.

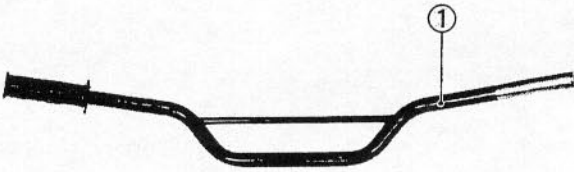

4. Inspect:

- Handlebar ①
- Bends/Cracks/Damage → Replace.

**⚠ WARNING**

Do not attempt to straighten a bent handlebar as this may dangerously weaken the handlebar.

\*\*\*\*\*

**Replacement steps:**

- Remove the handlebar grip.
- Apply a light coat of an adhesive for rubber on the left new handlebar end.
- Install the handlebar grip.

**NOTE:**

Wipe off excess adhesive with a clean rag.

**⚠ WARNING**

Leave the handlebar intact until the adhesive becomes dry enough to make the grip and handlebar stuck securely.

\*\*\*\*\*

YB375003

**INSTALLATION**

Reverse the "REMOVAL" procedure.  
Note the following points.

1. Lubricate:

- Bearing (upper and lower)
- Bearing races

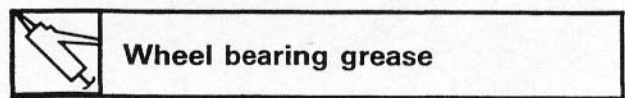

- 2. Install:
  - Bearing (lower) (onto steering stem)
  - Steering stem

**CAUTION:** \_\_\_\_\_

Hold the steering stem until it is secured.

- Bearing (upper)
- Bearing cover
- Ring nut

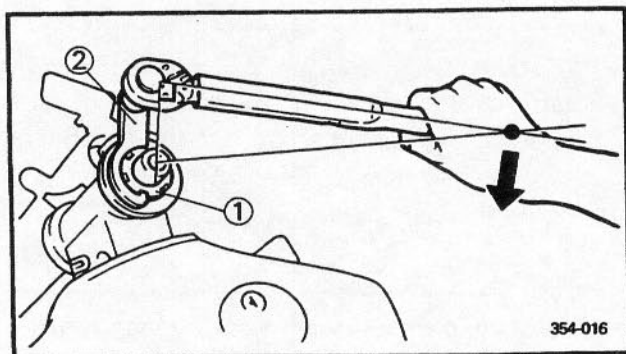

- 3. Tighten:
  - Ring nut (lower) ①

\*\*\*\*\*

**Tightening steps:**

- Tighten the ring nut (lower) using the ring nut wrench ②.

	<b>Ring nut wrench:</b> P/N. YU-33975, 90890-01403
---	---

**NOTE:** \_\_\_\_\_

Set the torque wrench to the ring nut wrench so that they form a right angle.

	<b>Ring nut (lower)</b> <b>(initial tightening):</b> 43 Nm (4.3 m•kg, 31 ft•lb)
---	---

- Turn the lower bracket to the left and right making sure there is no binding and then fully loosen the ring nut (lower).
- Retighten the ring nut (lower) using the ring nut wrench.

**⚠ WARNING** \_\_\_\_\_

Avoid over-tightening.

 **Ring nut (lower) (final tightening):**  
7 Nm (0.7 m•kg, 5.1 ft•lb)

- Install the rubber washer on the ring nut (lower); then finger tighten the ring nut (upper) until it contacts the rubber washer. Align the grooves of the lower and upper nuts and install the stopper washer.

\*\*\*\*\*

4. Install:
- Handlebar crown ①

**NOTE:** \_\_\_\_\_

Temporary tighten the steering fitting nut ②.

---

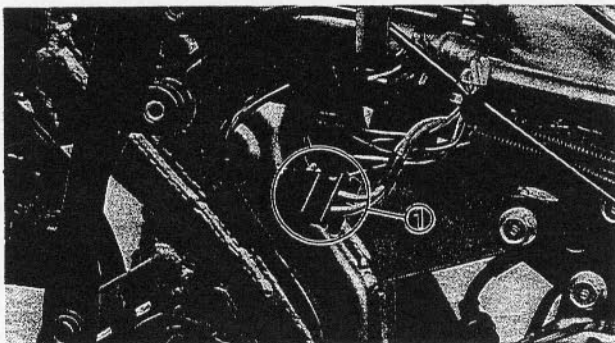
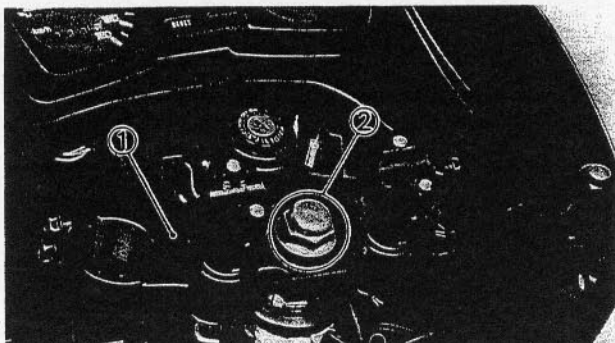

5. Connect:
- Main switch lead coupler ①

6. Install:
- Holder ① (brake hose)
  - Holder (speedometer cable and brake hose) ②

7. Connect:
- Brake hose (to holder ③)

8. Install:
- Bolt ④ (holder)

 **Bolt (holder ①):**  
7 Nm (0.7 m•kg, 5.1 ft•lb)  
**Bolt (holder ②):**  
7 Nm (0.7 m•kg, 5.1 ft•lb)  
**Bolt ④ (holder):**  
7 Nm (0.7 m•kg, 5.1 ft•lb)

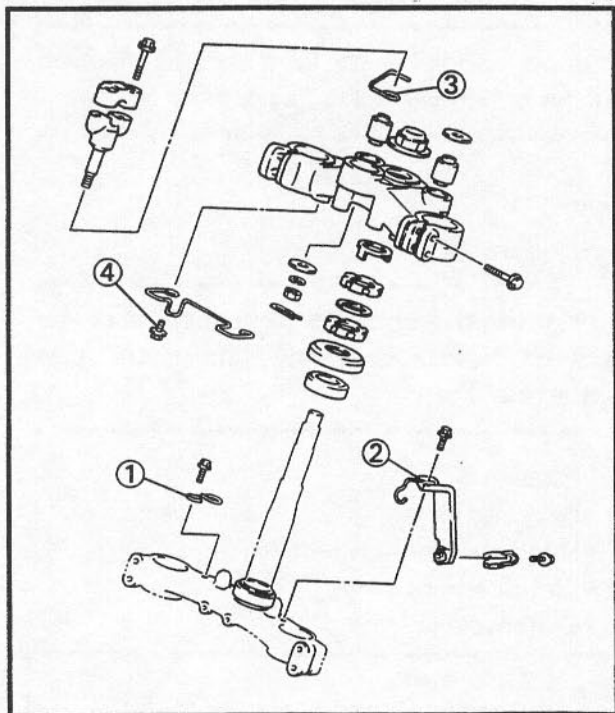



9. Install:

- Front fork

Refer to the "FRONT FORK—INSTALLATION" section.

	<b>Pinch bolt (lower bracket):</b> 23 Nm (2.3 m•kg, 17 ft•lb)
	<b>Pinch bolt (handlebar crown):</b> 23 Nm (2.3 m•kg, 17 ft•lb)

10. Tighten:

- Steering fitting nut ①

	<b>Steering fitting nut:</b> 110 Nm (11.0 m•kg, 80 ft•lb)
---	--

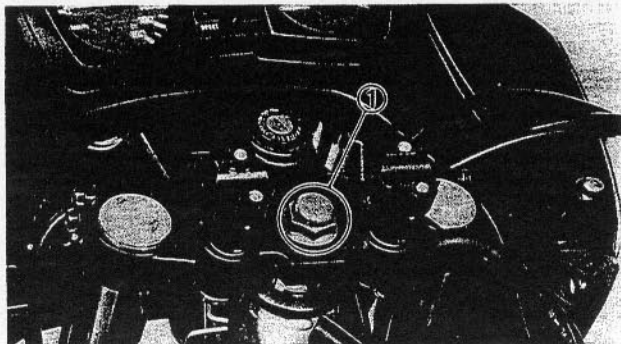

11. Install:

- Handlebar
- "CHOKE" knob

	<b>Bolt (handlebar):</b> 23 Nm (2.3 m•kg, 17 ft•lb)
---	--

**NOTE:** \_\_\_\_\_

The upper handlebar holder should be installed with the punch mark ① forward.

② Forward

**CAUTION:** \_\_\_\_\_

First tighten the bolts on the front side of the handlebar holder, and then tighten the bolts on the rear side.

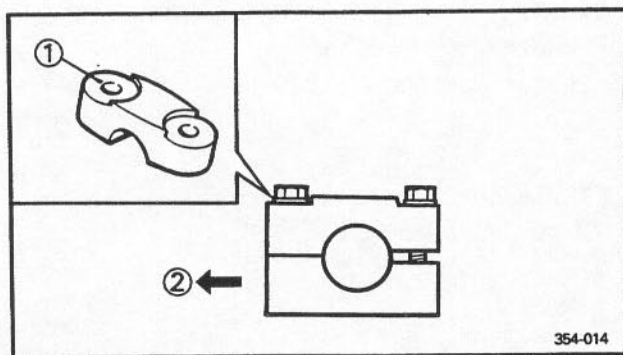

12. Install:

- Grip end (left)
- Handlebar switch (left)
- Clutch lever holder
- Clutch cable

	<b>Grip end:</b> 26 Nm (2.6 m•kg, 19 ft•lb)
---	--

**NOTE:** \_\_\_\_\_

Apply a light coat of lithium soap base grease onto the clutch cable end.

13. Connect:

- Bands

14. Install:

- Guard (left)

15. Install:

- Throttle grip
- Handlebar switch (right)
- Grip end

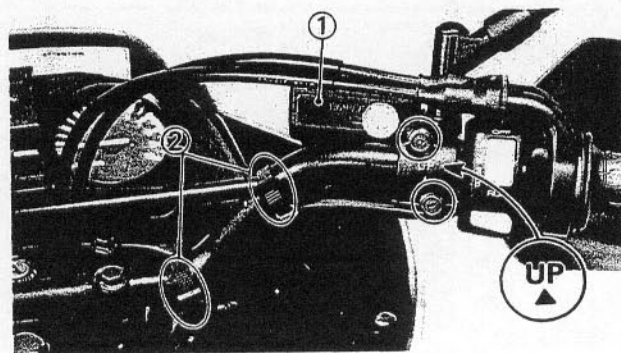
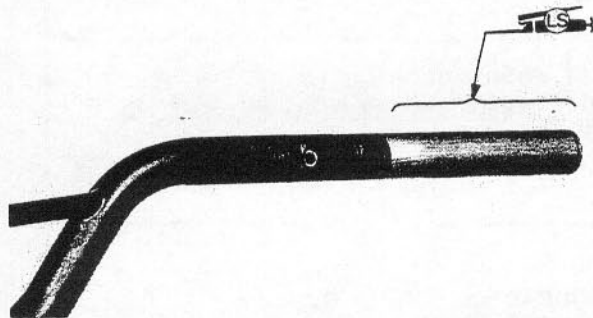
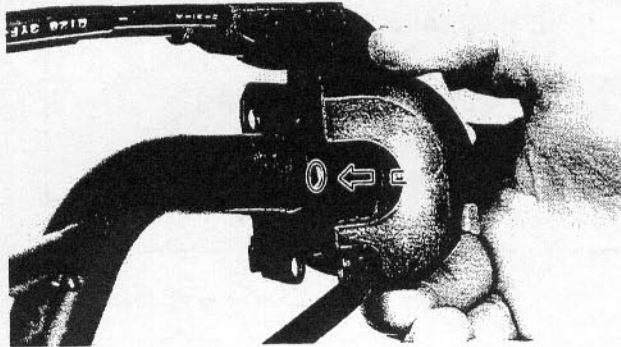

 **Grip end:**  
26 Nm (2.6 m•kg, 19 ft•lb)

**NOTE:** \_\_\_\_\_

- Before installing the throttle grip onto the handlebar, apply a light coat of lithium soap base grease onto the handlebar end and install the throttle grip to the handlebar.
- When installing the handlebar switch (right) make sure its projection fits into the hole as shown.

16. Install:

- Brake master cylinder (1)

**NOTE:** \_\_\_\_\_

- Install the master cylinder bracket with the "UP" mark facing upward.
- Tighten first the upper bolt, then the lower bolt.

 **Bolt (master cylinder bracket):**  
7 Nm (0.7 m•kg, 5.1 ft•lb)

17. Connect:

- Bands (2)



## 18. Install:

- Front fender
- Brake caliper
- Holder (brake hose)
- Cable band (speedometer cable)

Refer to the "FRONT FORK—INSTALLATION" section.

**Bolt (front fender):**

8 Nm (0.8 m•kg, 5.8 ft•lb)

**Bolt (brake caliper):**

35 Nm (3.5 m•kg, 25 ft•lb)

**Bolt (brake hose holder):**

7 Nm (0.7 m•kg, 5.1 ft•lb)

**Bolt (speedometer cable):**

0.7 Nm (0.07 m•kg, 0.5 ft•lb)

## 19. Install:

- Front wheel

Refer to the "FRONT WHEEL—INSTALLATION" section.

**Axle nut:**

110 Nm (11.0 m•kg, 80 ft•lb)

**Nut (axle holder):**

9 Nm (0.9 m•kg, 6.5 ft•lb)

## 20. Adjust:

- Clutch cable free play

**Free play:**

10~15 mm (0.4~0.6 in)

at lever end

Refer to the "CLUTCH ADJUSTMENT" section in the CHAPTER 3.

## 21. Install:

- Fuel tank
- Air scoops
- Side covers
- Seat

**Bolts (fuel tank, cowling and fuel tank, side cover):**

7 Nm (0.7 m•kg, 5.1 ft•lb)

**Bolt (seat):**

10 Nm (1.0 m•kg, 7.2 ft•lb)



REAR SHOCK ABSORBER AND SWINGARM

① Rear shock absorber assembly

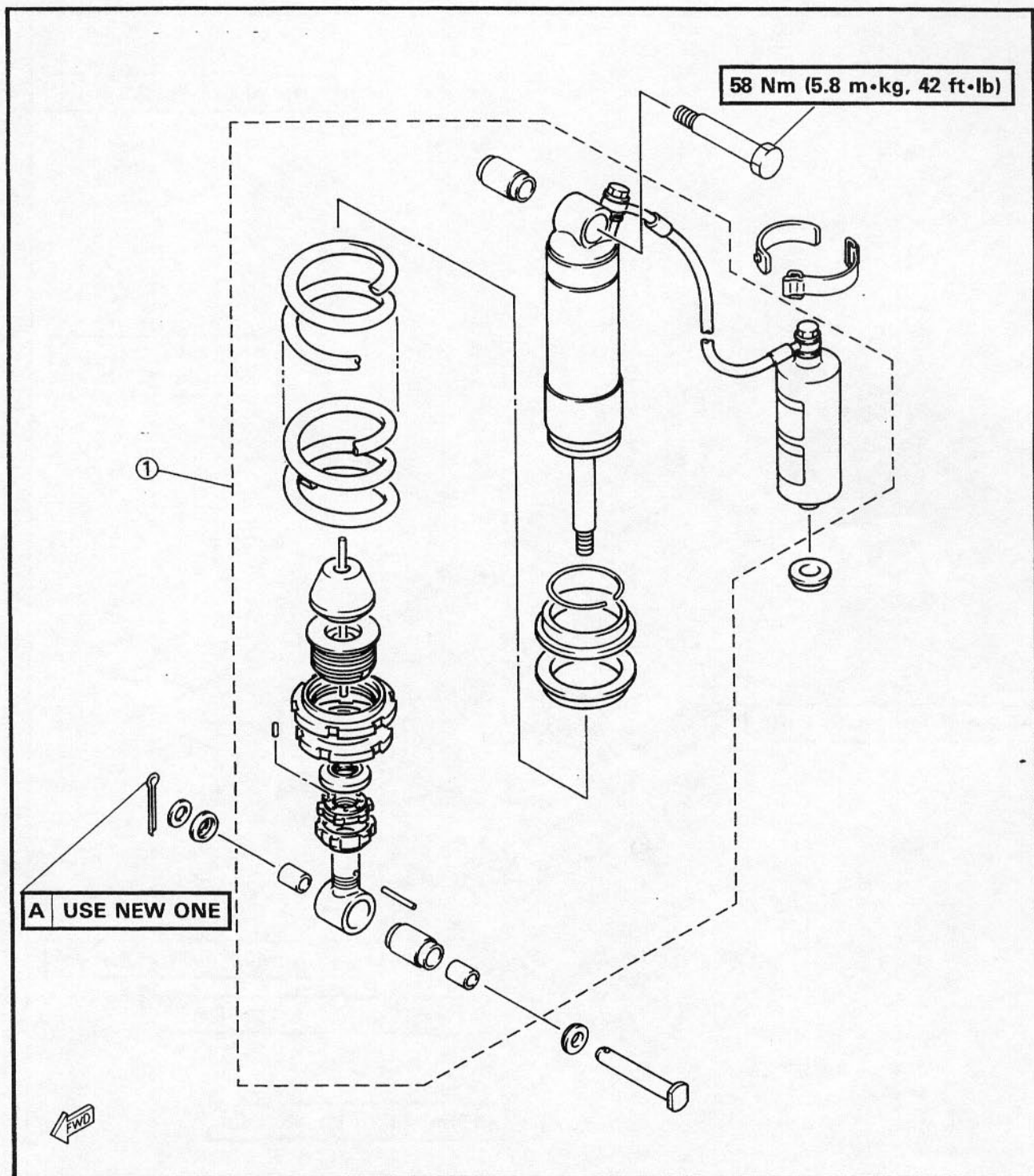

# REAR SHOCK ABSORBER AND SWINGARM

CHAS



- ① Swingarm
- ② Relay arm
- ③ Connection arm
- ④ Chain case
- ⑤ Chain protector
- ⑥ Chain guide

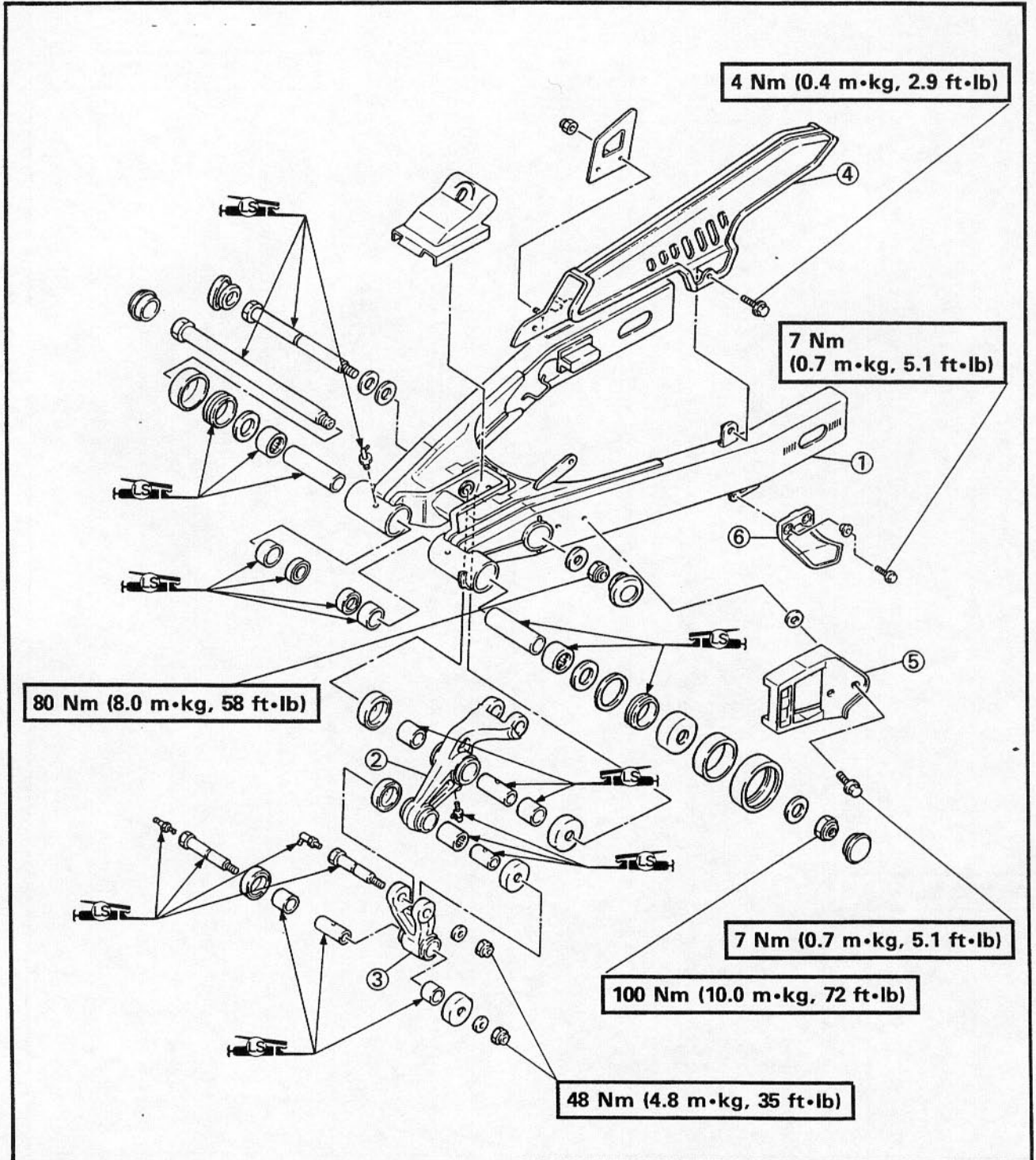

**HANDLING NOTES**

**⚠ WARNING**

This shock absorber assembly uses highly pressurized nitrogen gas. Read and understand the following information before handling the shock absorber. The manufacturer cannot be held responsible for property damage or personal injury that may result from improper handling.

- Do not tamper with or attempt to open the shock absorber assembly.
- Do not subject shock absorber assembly to an open flame or other high heat source. This may cause the unit to explode due to excessive gas pressure.
- Do not deform or damage the shock absorber assembly in any way. Damage will result in poor damping performance.
- Take care not to scratch the contact surface of the piston rod with the cylinder; or oil could leak out.
- When scrapping the shock absorber assembly, refer to the "NOTES ON DISPOSAL" section.

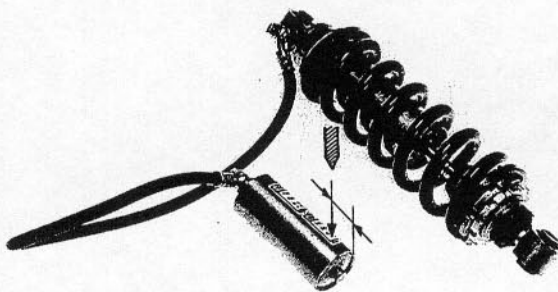

**NOTES ON DISPOSAL**

\*\*\*\*\*

**Shock absorber disposal steps:**

Gas pressure must be released before disposing of the shock absorber assembly. To do so, drill a 2~3 mm (0.08~0.12 in) hole through the chamber case at a point 15~20 mm (0.6~0.8 in) from the end of the chamber case.

**⚠ WARNING**

Wear eye protection to prevent eye damage from escaping gas and/or metal chips.

\*\*\*\*\*



## REMOVAL

### Rear shock absorber

#### **⚠ WARNING**

Securely support the motorcycle so there is no danger of it falling over.

1. Place the motorcycle on a level place.
2. Remove:
  - Seat
  - Side covers
  - Air scoops
  - Fuel tank
 Refer to the "SEAT, FUEL TANK AND COVER" section in the CHAPTER 3.
3. Elevate the rear wheel by placing a suitable stand under the frame and engine.
4. Remove:
  - Rear wheel
 Refer to the "REAR WHEEL—REMOVAL" section.

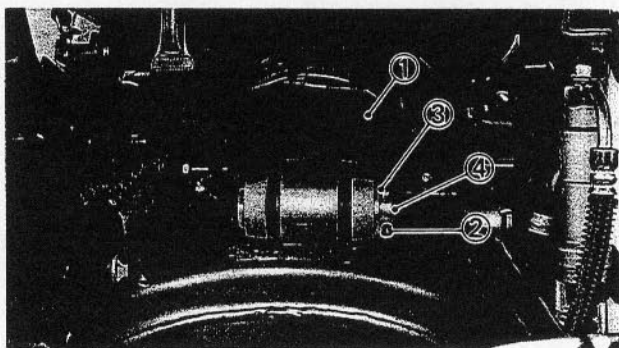

5. Pull up the rubber cover ①

#### 6. Remove:

- Cotter pin ②
- Washer ③
- Shaft ④

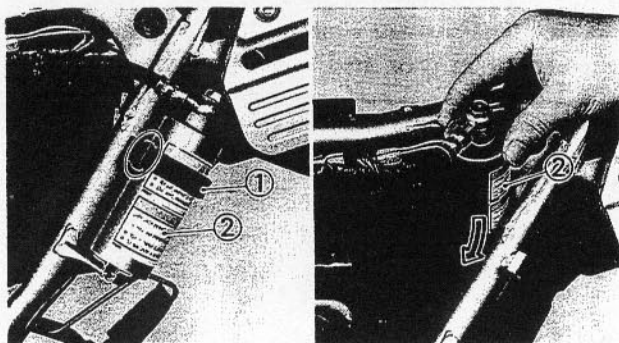

#### 7. Disconnect:

- Band ①
- Chamber case ② (shock absorber assembly)

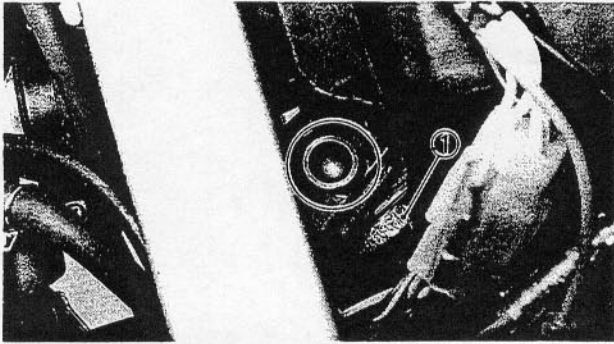

8. Remove:
- Rear shock absorber ①

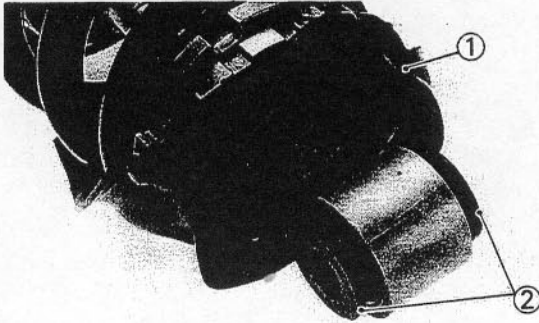

9. Remove:
- Rubber cover ①
  - Covers ②  
(from rear shock absorber)

## Swingarm

### **⚠ WARNING**

Securely support the motorcycle so there is no danger of it falling over.

1. Place the motorcycle on a level place.
2. Elevate the rear wheel by placing a suitable stand under the frame and engine.
3. Remove:
  - Rear shock absorber
 Refer to the "REAR SHOCK ABSORBER" section.

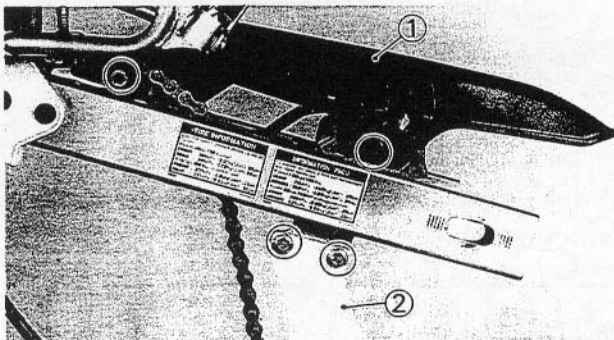

4. Remove:
- Chain case ①
  - Chain guide ②

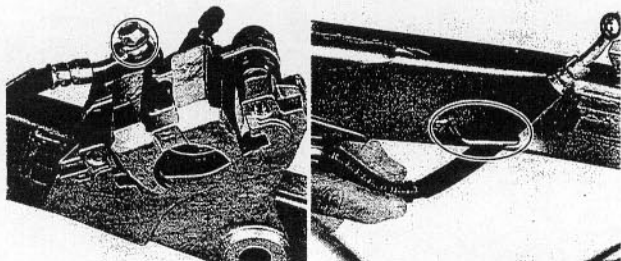

5. Remove:
- Brake hose
- Refer to the "FRONT AND REAR BRAKE" section.

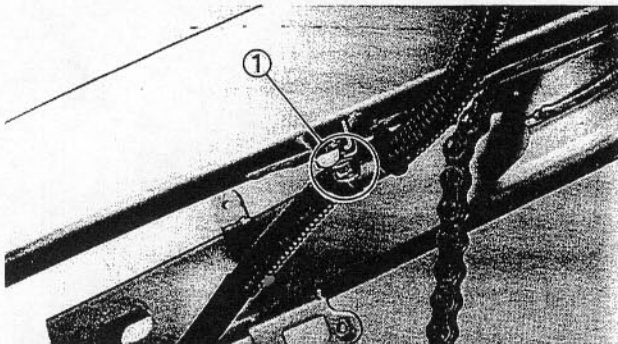

6. Remove:
- Bolts ① (hose clamp)

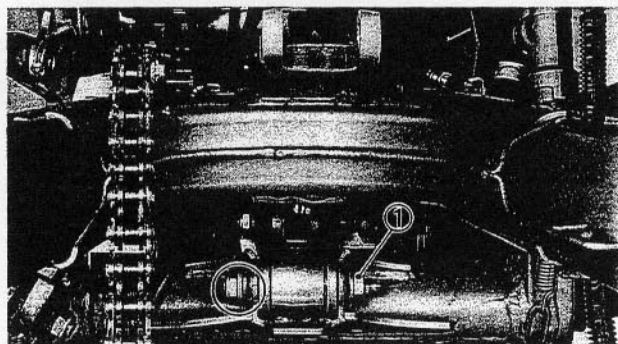

7. Remove:
- Bolt ① (connecting arm)

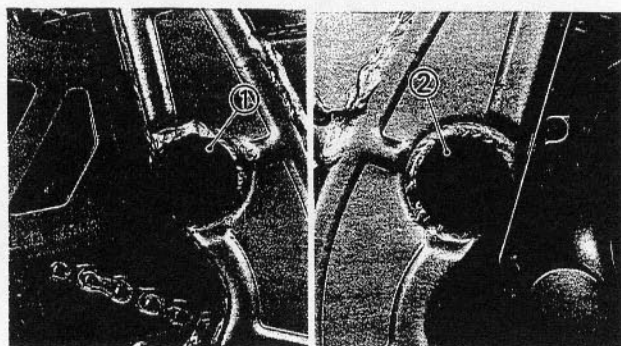

8. Remove:
- Cap ① (pivot shaft)
  - Cap ② (pivot shaft)

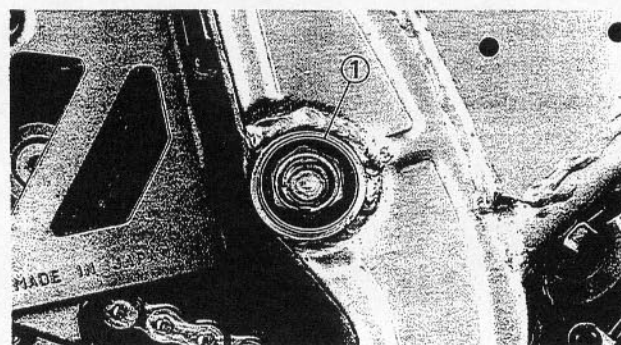

9. Check:
- Swingarm free play

\*\*\*\*\*

**Inspection steps:**

- Check the tightening torque of the pivot shaft (swingarm) securing nut ①.

	<p><b>Nut (pivot shaft):</b> 100 Nm (10.0 m•kg, 72 ft•lb)</p>
---	---



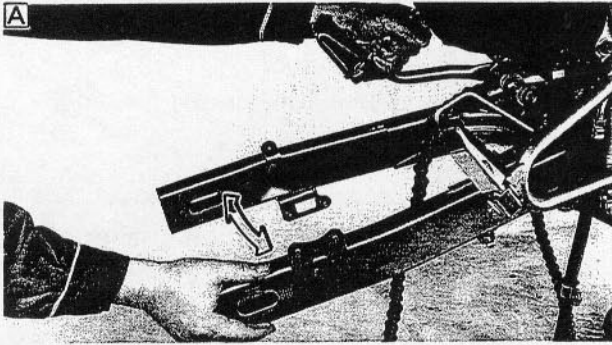

- Check the swingarm side play **A** by moving it from side to side.  
If side play noticeable, check the inner collar, bearing, washer and thrust cover.

 **Side play (at end of swingarm):**  
Limit: 1.0 mm (0.04 in)

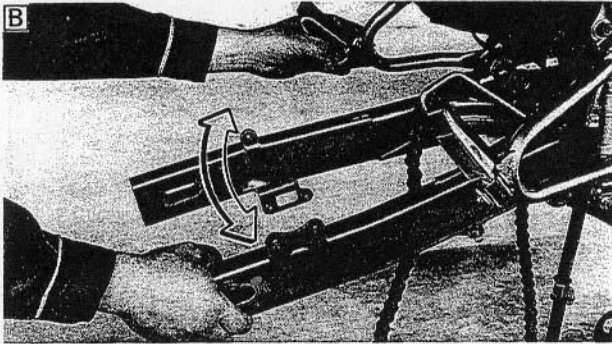

- Check the swingarm vertical movement **B** by moving it up and down.  
If vertical movement is tight, binding or rough, check the inner collar, bearing, washer and thrust cover.

\*\*\*\*\*

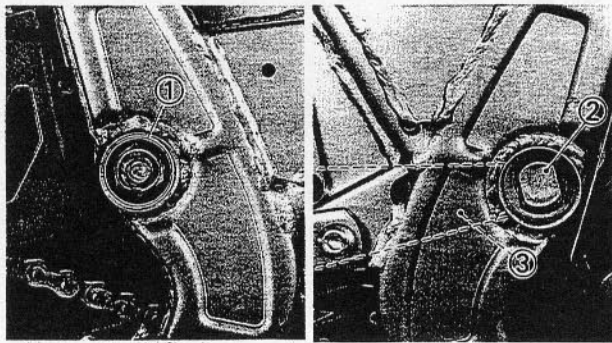

10. Remove:
- Nut (pivot shaft) ①
  - Washer
  - Pivot shaft ②
  - Swingarm ③

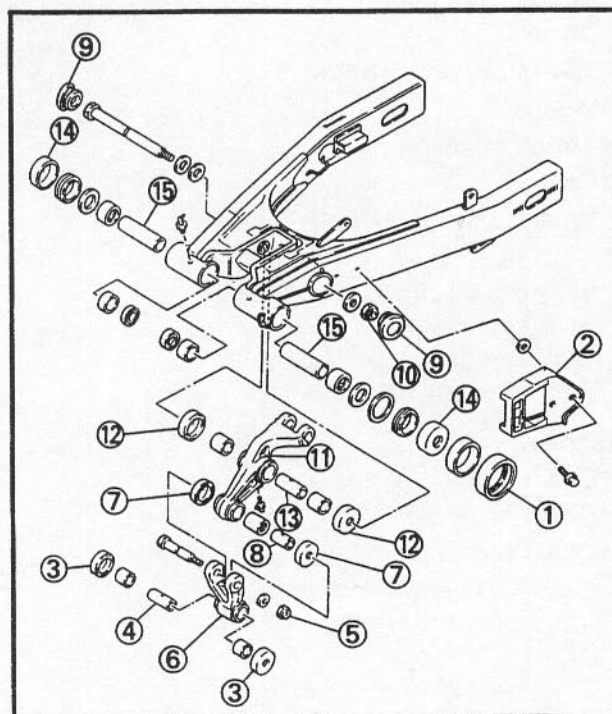

11. Remove:
- Chain protector roller ①
  - Chain protector ②
  - Thrust cover ③ (connecting arm)
  - Collar ④ (connecting arm)
  - Nut ⑤ (connecting arm—relay arm)
  - Connecting arm ⑥
  - Thrust cover ⑦ (relay arm)
  - Collar ⑧ (relay arm)
  - Rubber cap ⑨
  - Nut ⑩ (relay arm—swingarm)
  - Relay arm ⑪
  - Thrust cover ⑫ (relay arm)
  - Collar ⑬ (relay arm)
  - Thrust cover ⑭ (swingarm)
  - Collar ⑮ (swingarm)

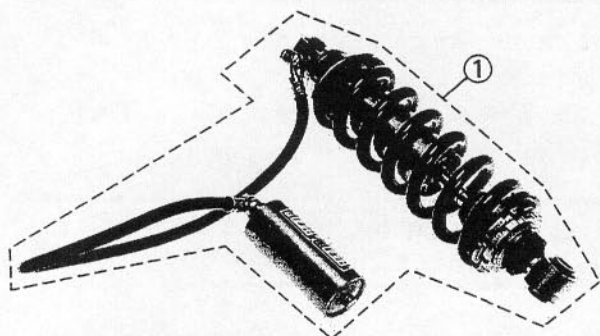

## INSPECTION

### 1. Inspect:

- Shock absorber assembly ①  
Oil leaks/Damage → Replace the shock absorber assembly.

### **⚠ WARNING**

Do not disassemble the shock absorber assembly, because of the highly pressurized nitrogen gas in it.

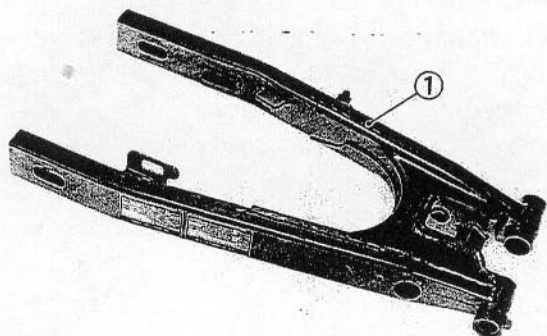

### 2. Inspect:

- Swingarm ①  
Bends/Cracks/Damage → Replace.

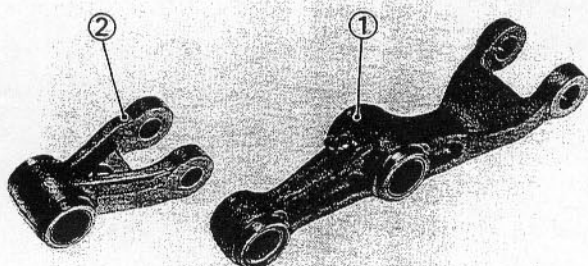

### 3. Inspect:

- Relay arm ①
- Connecting arm ②  
Bends/Cracks/Damage → Replace.

### 4. Inspect:

- Oil seal  
Wear/Damage → Replace.
- Washer
- Thrust cover
- Collar  
Wear/Damage → Replace.
- Bush  
Scratches/Damage → Replace.
- Bearing  
Pitting/Damage → Replace.

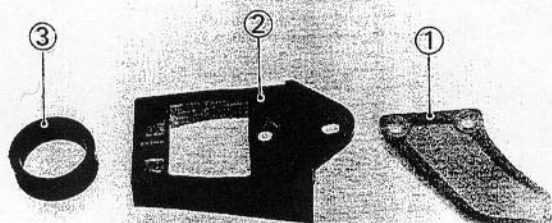

### 5. Inspect:

- Chain guide ①
- Chain protector ②
- Chain protector roller ③  
Cracks/Damage → Replace.

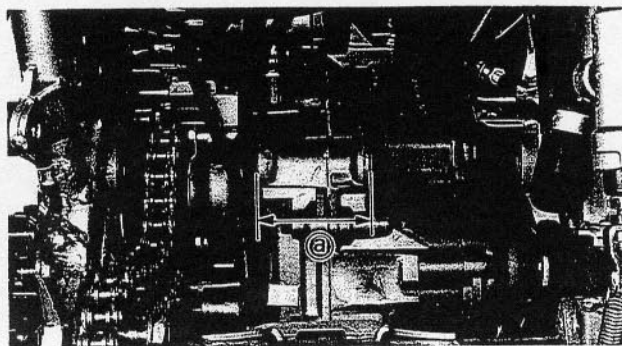

YB276005

## SIDE CLEARANCE ADJUSTMENT

### 1. Measure:

- Engine mounting boss width (a)

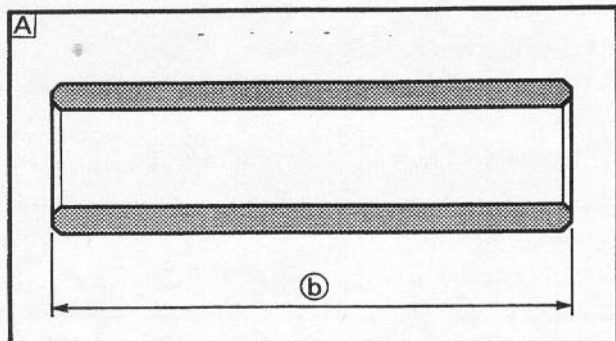

### 2. Measure:

- Bush length (b) and (c)
- Out of specification → Replace.



### Specified length:

b: 80.95 ~ 81.10 mm  
(3.187 ~ 3.193 in)

c: 74.90 ~ 75.00 mm  
(2.949 ~ 2.953 in)

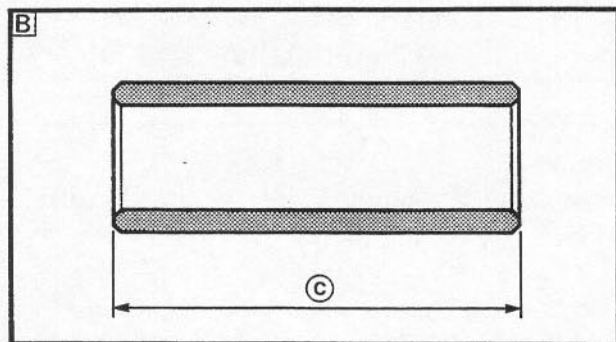

- A** Bush (right hand)
- B** Bush (left hand)

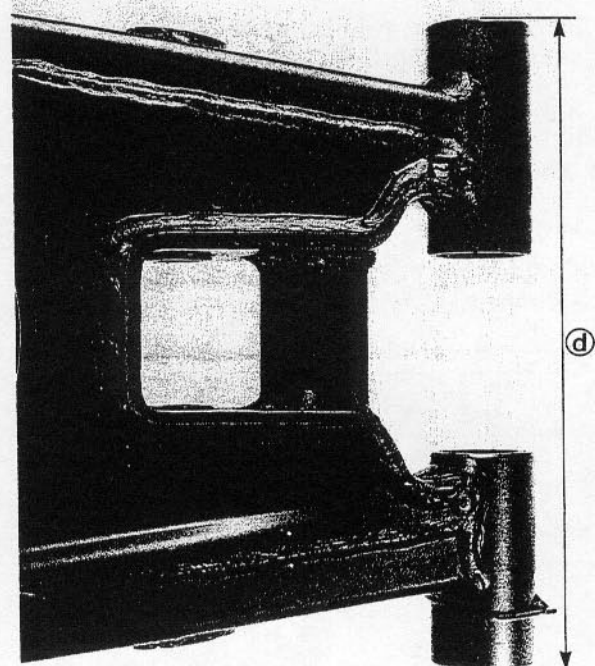

### 3. Measure:

- Pivot width (d)



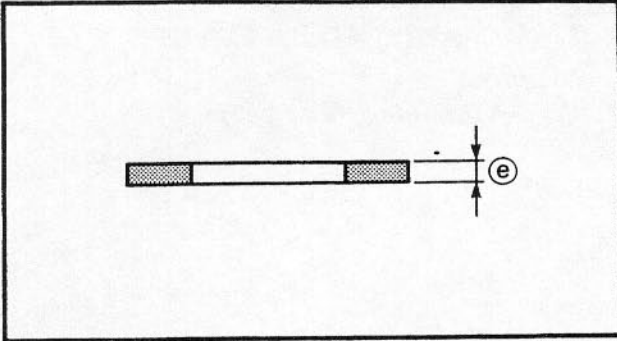

4. Measure:

- Washer thickness (e)  
Out of specification → Replace.

 **Washer thickness:**  
1.90 ~ 2.00 mm (0.075 ~ 0.079 in)

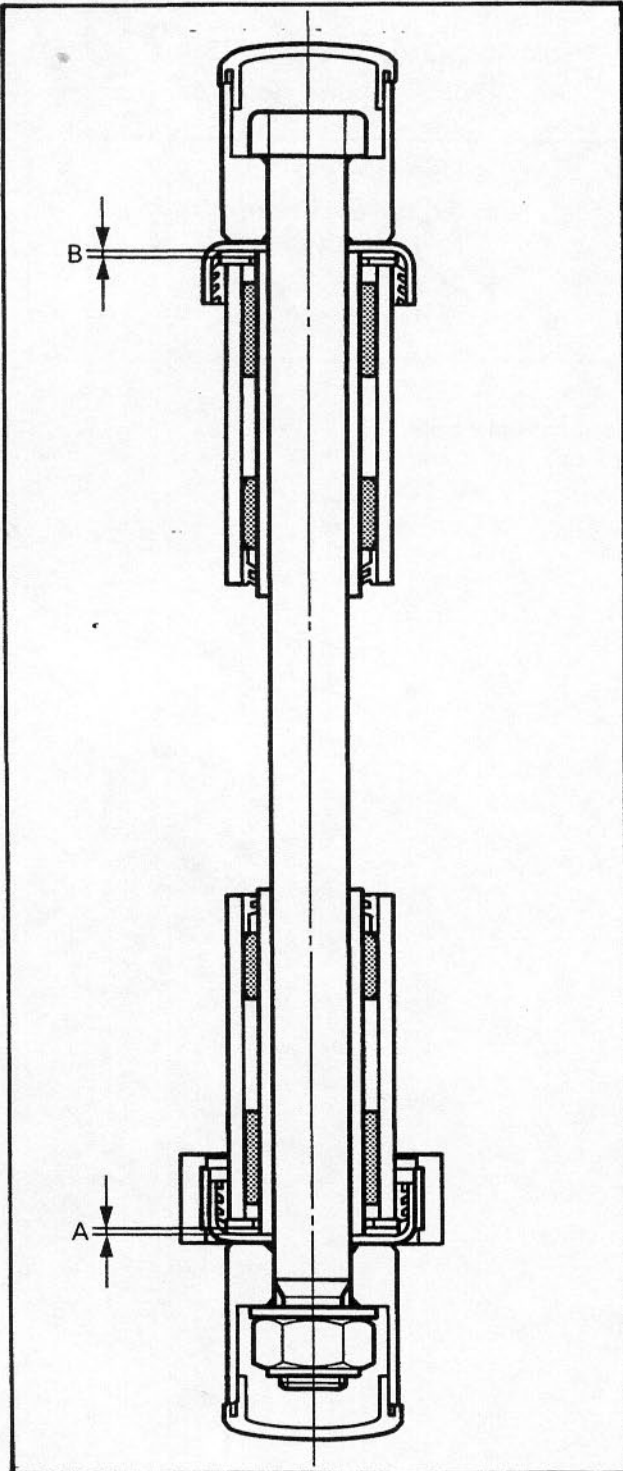

5. Calculate:

- Swingarm side clearance  
Out of specification → Adjust side clearance using shim.  
By using formula given below.

**Side clearance:**  
 $= (a + b + c) - (d + e \times 2)$

 **Side clearance: A + B**  
0.4 ~ 0.7 mm (0.016 ~ 0.028 in)

\*\*\*\*\*

**Example:**

- If the engine mounting boss width (a), bush length (b), (c) are below.

- (a): 63.6 mm (2.50 in)
- (b): 80.95 mm (3.187 in)
- (c): 74.90 mm (2.949 in)

- If the pivot width (d) and washer thickness (e) are below.

- (d): 214.9 mm (8.46 in)
- (e): 1.90 mm (0.07 in)

- Side clearance  
 $= (63.6 + 80.95 + 74.90) - (214.9 + 1.90 \times 2)$   
 $= 0.8 \text{ mm (0.03 in)}$

 **Shim thickness:**  
0.3 mm (0.012 in)

0.8 mm - 0.7 mm = 0.1 mm (0.004 in)  
Then, install the one shim.

\*\*\*\*\*

YBZ76006

## INSTALLATION

### Rear shock absorber

Reverse the "REMOVAL" procedure.

Note the following points.

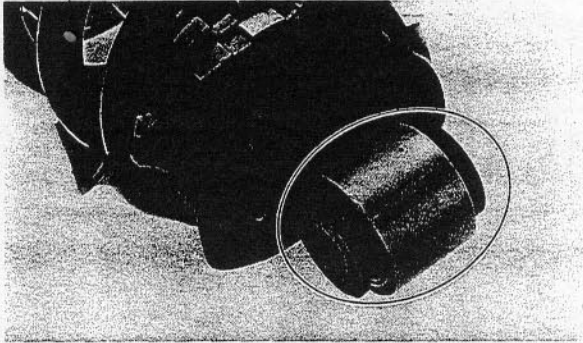

1. Lubricate:

- Bush (inner surface)
- Covers

	<b>Lithium soap base grease</b>
---	---------------------------------

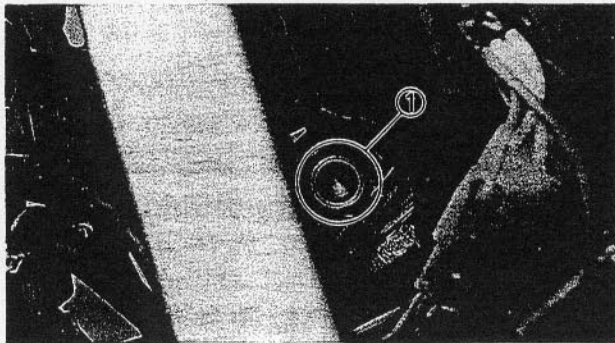

2. Tighten:

- Bolt ① (rear shock absorber)

	<b>Bolt ① (rear shock absorber): 58 Nm (5.8 m·kg, 42 ft·lb)</b>
---	---

3. Connect:

- Chamber case
- Band

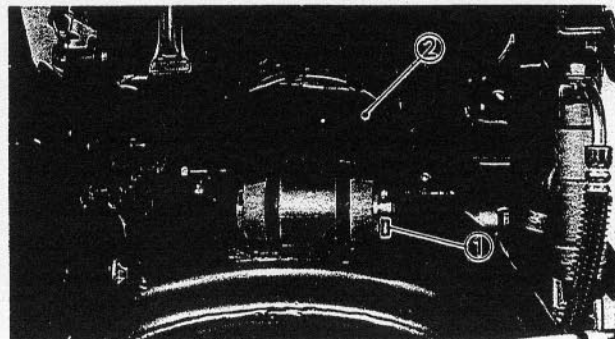

4. Install:

- Cotter pin ①
- Rubber cover ②

**NOTE:** \_\_\_\_\_

Bend the ends of the cotter pin.

\_\_\_\_\_

**⚠ WARNING** \_\_\_\_\_

Always use a new cotter pin.

\_\_\_\_\_

## Swingarm

Reverse the "REMOVAL" procedure.  
Note the following points.

1. Lubricate:
  - Bearing
  - Bushing
  - Thrust cover (inside)
  - Collar
  - Pivot shaft
  - Bolt (relay arm—swingarm)
  - Bolt (connecting arm—relay arm)
  - Bolt (connecting arm—frame)



**Lithium soap base grease**

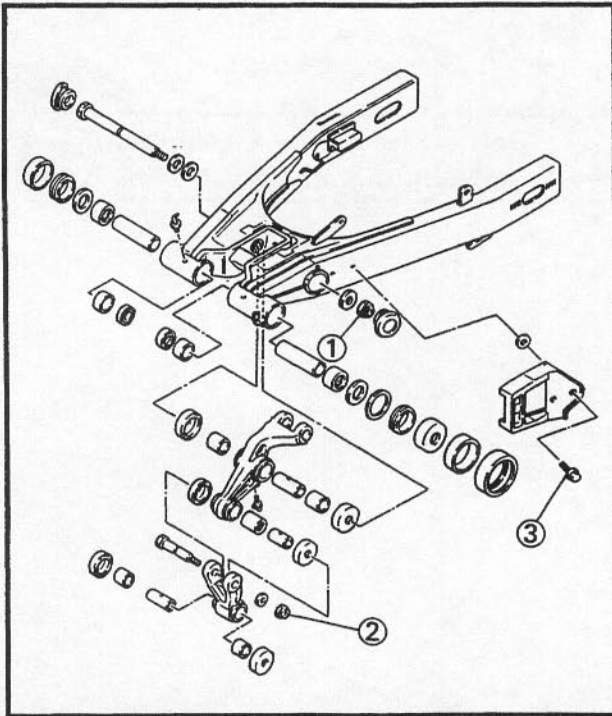

2. Tighten:
  - Nut ① (relay arm—swingarm)
  - Nut ② (relay arm—connecting arm)
  - Bolt ③ (chain protector)



**Nut (relay arm—swingarm):**  
80 Nm (8.0 m•kg, 58 ft•lb)

**Nut (relay arm—connecting arm):**  
48 Nm (4.8 m•kg, 35 ft•lb)

**Bolt (chain protector):**  
7 Nm (0.7 m•kg, 5.1 ft•lb)

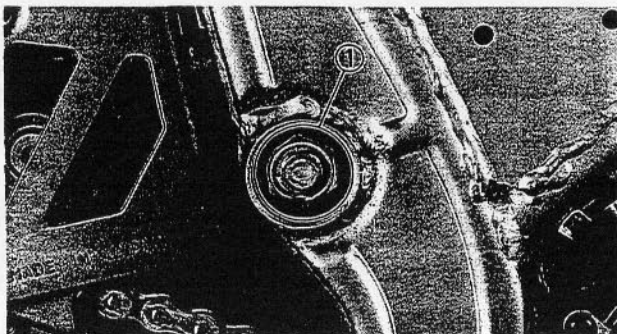

3. Tighten:
  - Nut ① (pivot shaft)



**Nut ① (pivot shaft):**  
100 Nm (10.0 m•kg, 72 ft•lb)



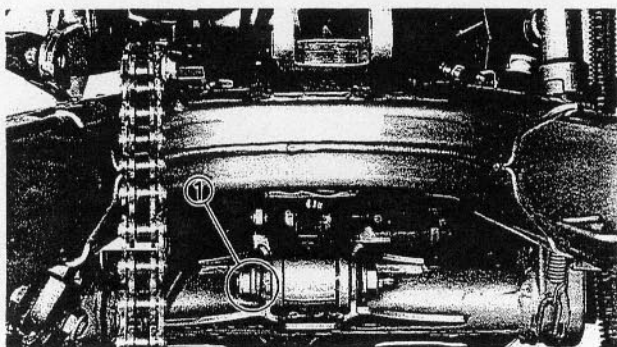

4. Tighten:
- Nut ① (connecting arm—frame)

 **Nut ① (connecting arm—frame):**  
48 Nm (4.8 m•kg, 35 ft•lb)

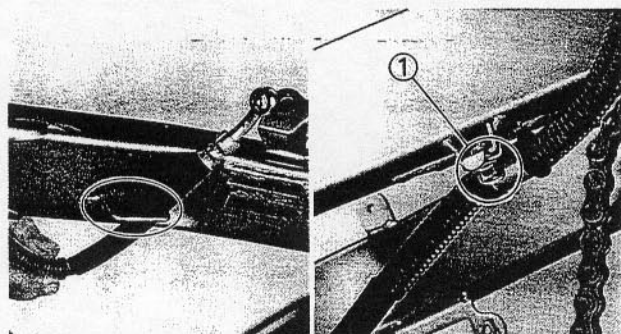

5. Tighten:
- Bolt ① (hose clamp)

 **Bolt (hose clamp):**  
7 Nm (0.7 m•kg, 5.1 ft•lb)

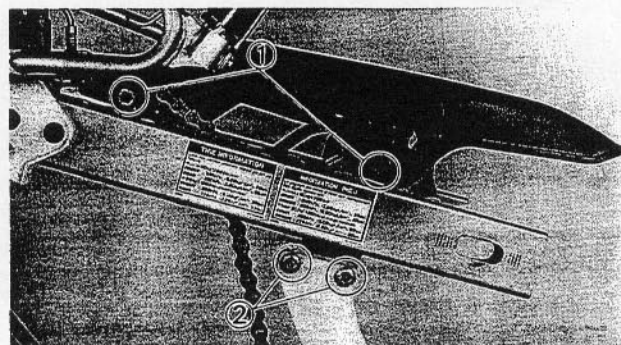

6. Install:
- Brake hose
- Refer to the "CABLE ROUTING" section in the CHAPTER 2.

7. Tighten:
- Bolt ① (chain case)
  - Bolt ② (chain guide)

 **Bolt (chain case):**  
4 Nm (0.4 m•kg, 2.9 ft•lb)  
**Bolt (chain guide):**  
7 Nm (0.7 m•kg, 5.1 ft•lb)

8. Install:
- Rear shock absorber
- Refer to the "REAR SHOCK ABSORBER—INSTALLATION" section.

9. Install:
- Rear wheel
- Refer to the "REAR WHEEL—INSTALLATION" section.

 **Retaining bolt (brake caliper):**  
23 Nm (2.3 m•kg, 17 ft•lb)

10. Adjust:
- Drive chain slack

 **Drive chain slack:**  
20 ~ 45 mm (0.79 ~ 1.77 in)

Refer to the "DRIVE CHAIN SLACK ADJUSTMENT" section in the CHAPTER 3.

11. Tighten:
- Axle nut
  - Locknut (chain puller)

	<b>Axle nut:</b>
	<b>100 Nm (10.0 m•kg, 72 ft•lb)</b>
	<b>Locknut (chain puller):</b>
	<b>15 Nm (1.5 m•kg, 11 ft•lb)</b>

Refer to the "REAR WHEEL—INSTALLATION" section.

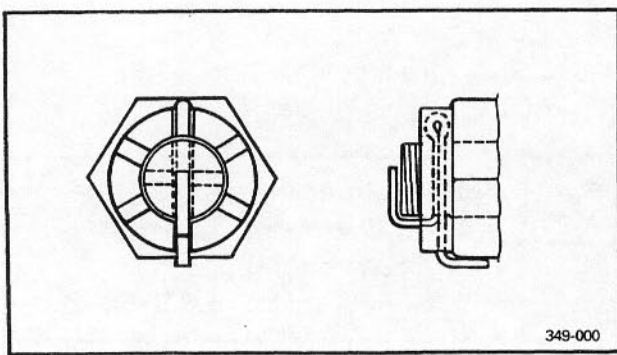

12. Install:
- Cotter pin

**NOTE:** \_\_\_\_\_  
 Bend the ends of the cotter pin as illustration.

**! WARNING** \_\_\_\_\_  
 Always use a new cotter pin.

13. Install:
- Fuel tank
  - Air scoops
  - Side covers
  - Seat

	<b>Bolt (fuel tank, cowling and fuel tank, side covers):</b>
	<b>7 Nm (0.7 m•kg, 5.1 ft•lb)</b>
	<b>Bolt (seat):</b>
	<b>10 Nm (1.0 m•kg, 7.2 ft•lb)</b>

DRIVE CHAIN AND SPROCKETS

- ① Driven sprocket
- ② Drive chain
- ③ Bearing
- ④ Collar
- ⑤ Oil seal

A	DRIVE CHAIN
B	TYPE: 520V6, 520SMCZ9
C	NO. OF LINKS: 110
D	DRIVE CHAIN SLACK: 20~45 mm (0.79~1.77 in)

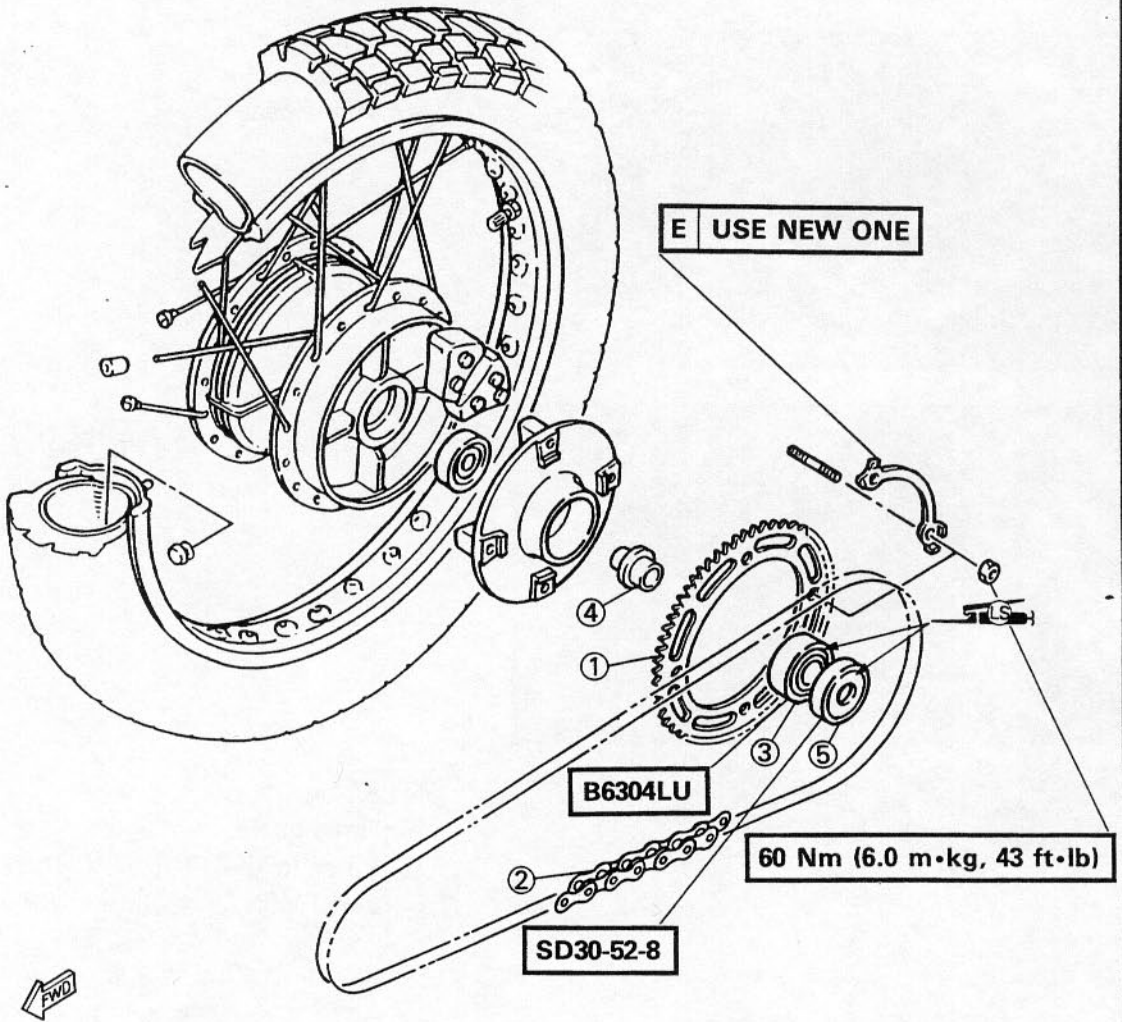



YB277000

**NOTE:** \_\_\_\_\_

Before removing the drive chain and sprockets, drive chain slack and 10-link length of drive chain should be measured.

---

YB277001

**REMOVAL**

1. Elevate the rear wheel by placing a suitable stand under the frame and engine.

**⚠ WARNING** \_\_\_\_\_

Securely support the motorcycle so there is no danger of it falling over.

---

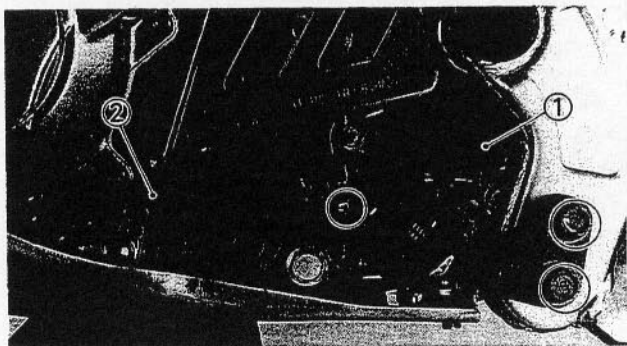

2. Remove:
  - Footrest ①
  - Shift pedal ②

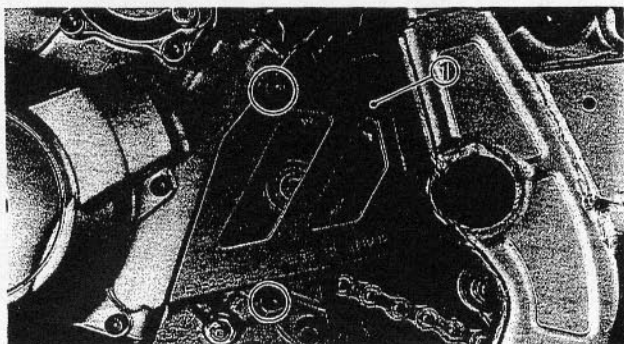

3. Remove:
  - Cover ① (drive sprocket)

4. Loosen:
  - Drive chainRefer to the "DRIVE CHAIN SLACK ADJUSTMENT" section in the CHAPTER 3.

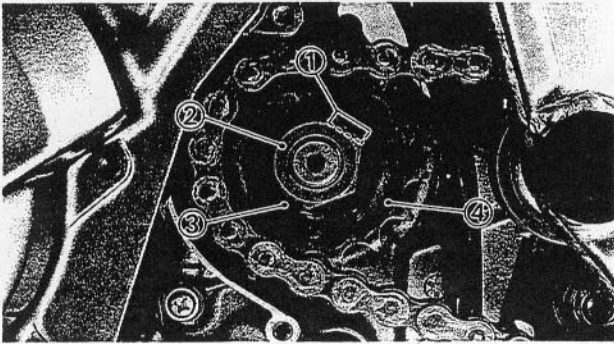

5. Straighten:

- Lock washer tab ① *902152326500*

6. Remove:

- Nut (drive sprocket) ②
- Lock washer ③
- Drive sprocket ④

**NOTE:** \_\_\_\_\_

Loosen the nut (drive sprocket) while applying the rear brake.

---

7. Remove:

- Rear wheel  
Refer to the "REAR WHEEL" section.
- Swingarm  
Refer to the "REAR SHOCK ABSORBER AND SWINGARM" section.
- Drive chain

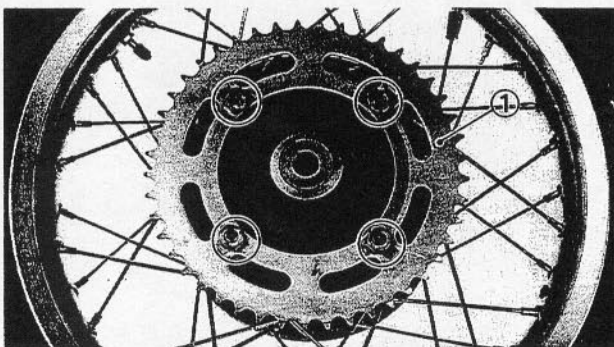

8. Remove:

- Driven sprocket ①  
Refer to the "INSPECTION—Replacement steps" section.

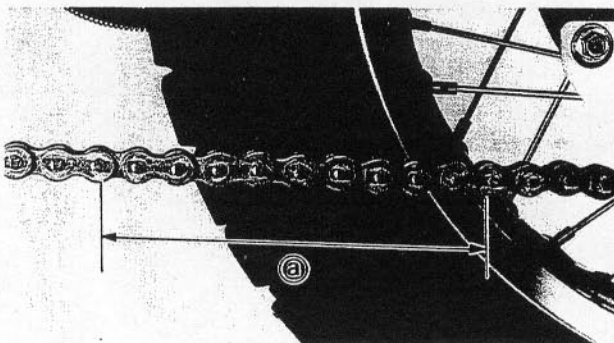

YB277002

**INSPECTION**

1. Measure:

- 10-link length (a) (drive chain)  
Out of specification → Replace drive chain.

	<b>10-link length limit:</b>
	<b>150.0 mm (5.91 in)</b>

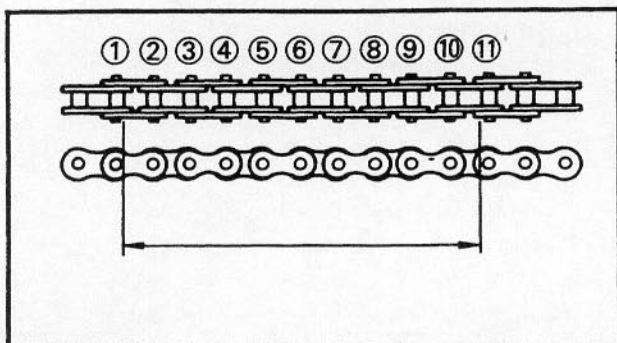

**NOTE:**

- For measurement make the chain tense by finger.
- 10-link length is a measurement between the insides of the ① and ⑪ rollers as shown.
- Two or three different 10-link length should be measured.

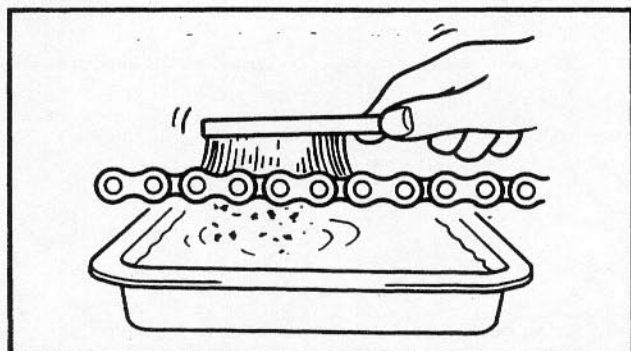

**2. Clean:**

- Drive chain  
Place it in kerosene, and brush off as much dirt as possible. Then remove the chain from the kerosene and dry the chain.

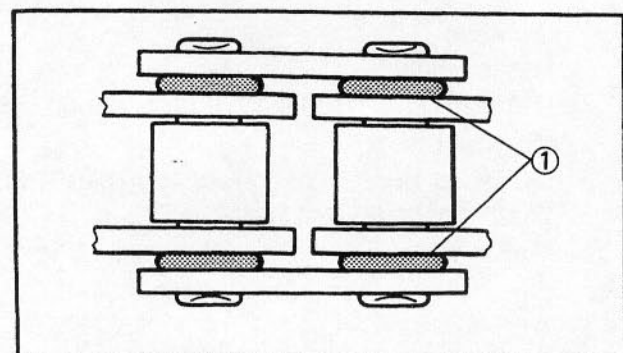

**CAUTION:**

This motorcycle has a drive chain with small rubber O-rings ① between the chain plates. Steam cleaning, high-pressure washers, and certain solvent can damage these O-rings. Use only kerosene to clean the drive chain.

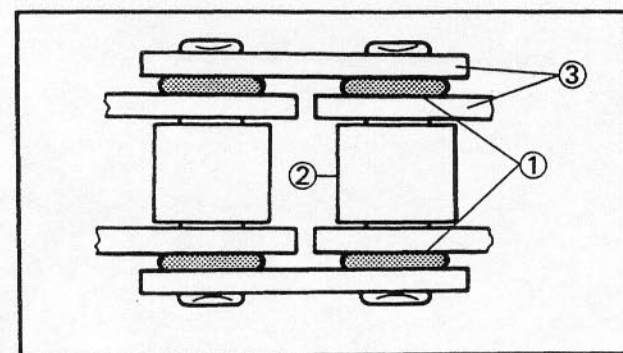

**3. Inspect:**

- O-ring ① (drive chain)  
Damage → Replace drive chain.
- Rollers ②
- Side plates ③  
Damage/Wear → Replace drive chain.

**4. Lubricate:**

- Drive chain



**Drive chain lubricant:**  
SAE 30~50W motor oil



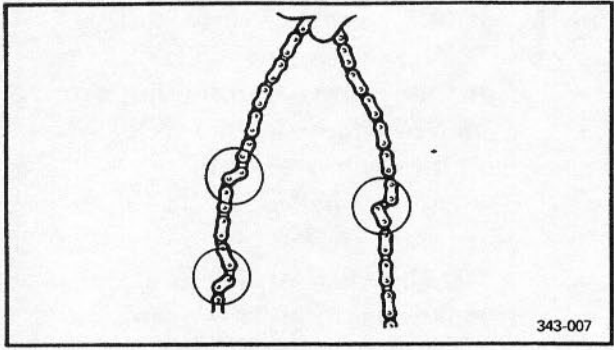

343-007

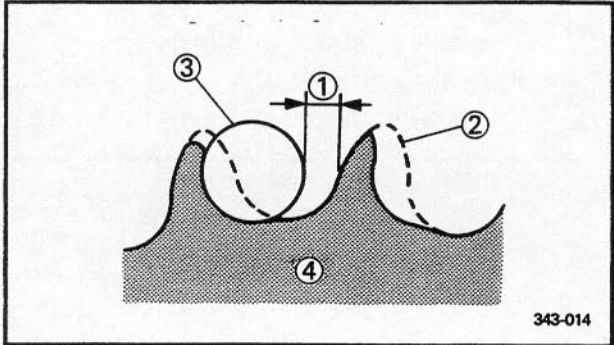

343-014

5. Inspect:
- Drive chain stiffness  
Stiff → Clean and lubricate or replace.

6. Inspect:
- Drive sprocket
  - Driven sprocket  
More than 1/4 teeth ① wear → Replace sprocket.  
Bent teeth → Replace sprocket.

- ② Correct
- ③ Roller
- ④ Sprocket

\*\*\*\*\*

**Replacement steps:**

- Straighten the lock washer tabs and remove the driven sprocket.
- Install a new driven sprocket and lock washers.

**⚠ WARNING** \_\_\_\_\_

**Always use new lock washers.**

	<p><b>Nut (driven sprocket):</b> <b>60 Nm (6.0 m•kg, 43 ft•lb)</b></p>
---	--

- Bend the washer tabs along the nut flats.

\*\*\*\*\*

YB277003

**INSTALLATION**

Reverse the "REMOVAL" procedure.  
Note the following points.

1. Install:
- Drive chain
  - Swingarm  
Refer to the "REAR SHOCK ABSORBER AND SWINGARM" section.



- Nut (relay arm—swingarm):  
80 Nm (8.0 m•kg, 58 ft•lb)
- Nut (relay arm—connecting arm):  
48 Nm (4.8 m•kg, 35 ft•lb)
- Bolt (chain protector):  
7 Nm (0.7 m•kg, 5.1 ft•lb)
- Nut (pivot shaft):  
100 Nm (10.0 m•kg, 72 ft•lb)
- Nut (connecting arm—frame):  
48 Nm (4.8 m•kg, 35 ft•lb)
- Bolt (chain case):  
4 Nm (0.4 m•kg, 2.9 ft•lb)
- Bolt (chain guide):  
7 Nm (0.7 m•kg, 5.1 ft•lb)

2. Install:

- Rear shock absorber  
Refer to the "REAR SHOCK ABSORBER AND SWINGARM" section.



- Bolt (rear shock absorber):  
58 Nm (5.8 m•kg, 42 ft•lb)

**⚠ WARNING**

Always use a new cotter pin.

3. Install:

- Rear wheel  
Refer to the "REAR WHEEL—INSTALLATION" section.



- Retaining bolt (brake caliper):  
23 Nm (2.3 m•kg, 17 ft•lb)

4. Install:

- Drive chain ①
- Drive sprocket ②
- Lock washer ③
- Nut (drive sprocket) ④



- Nut (drive sprocket):  
110 Nm (11.0 m•kg, 80 ft•lb)

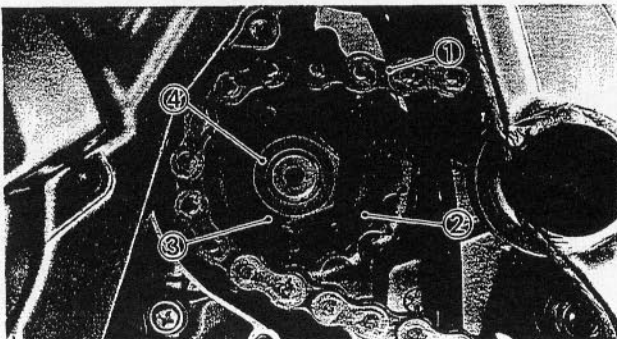

**NOTE:** \_\_\_\_\_

- Tighten the nut (drive sprocket) while applying the rear brake.
- After tightening the nut, bend the lock washer tab along the nut flats.

**⚠ WARNING** \_\_\_\_\_

Always use a new lock washer.

5. Install:

- Cover (drive sprocket)
- Shift pedal
- Footrest

	<p><b>Bolt (cover):</b> 10 Nm (1.0 m•kg, 7.2 ft•lb)</p> <p><b>Bolt (shift pedal):</b> 10 Nm (1.0 m•kg, 7.2 ft•lb)</p> <p><b>Bolt (footrest):</b> 50 Nm (5.0 m•kg, 36 ft•lb)</p>
---	---

6. Adjust:

- Drive chain slack  
Refer to the "DRIVE CHAIN SLACK ADJUSTMENT" section in the CHAPTER 3.

	<p><b>Drive chain slack:</b> 20 ~ 45 mm (0.79 ~ 1.77 in)</p>
---	--

**CAUTION:** \_\_\_\_\_

Too small chain slack will overload the engine and other vital parts; keep the slack within the specified limits.

7. Tighten:

- Axle nut
- Locknut (chain puller)

	<p><b>Axle nut:</b> 100 Nm (10.0 m•kg, 72 ft•lb)</p> <p><b>Locknut (chain puller):</b> 15 Nm (1.5 m•kg, 11 ft•lb)</p>
---	---

Refer to the "REAR WHEEL – INSTALLATION" section.



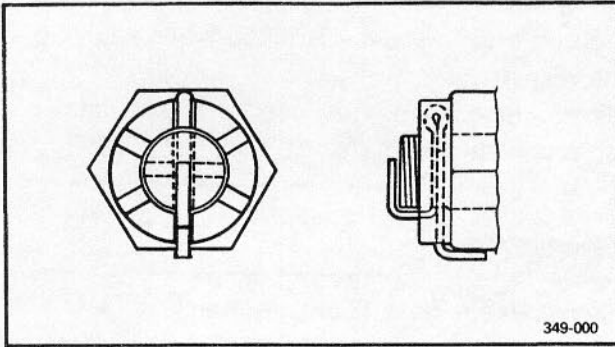

8. Install:

- Cotter pin

NOTE: \_\_\_\_\_

Bend the ends of the cotter pin as illustration.

\_\_\_\_\_

**⚠ WARNING** \_\_\_\_\_

Always use a new cotter pin.

\_\_\_\_\_



## CHAPTER 8. ELECTRICAL

<b>XTZ660 CIRCUIT DIAGRAM</b> .....	L-15
COLOR CODE .....	L-15
<b>ELECTRICAL COMPONENTS</b> .....	L-16
<b>CHECKING OF SWITCHES</b> .....	M-1
SWITCH CONNECTION AS SHOWN IN MANUAL .....	M-1
CHECKING SWITCH FOR TERMINAL CONNECTION .....	M-1
<b>CHECKING OF BULBS (FOR HEADLIGHT, TAIL/BRAKE, LIGHT, FLASHER LIGHT, METER LIGHT, ETC)</b> .....	M-3
KINDS OF BULBS .....	M-3
CHECKING BULB CONDITION .....	M-3
<b>IGNITION SYSTEM</b> .....	M-4
CIRCUIT DIAGRAM .....	M-4
TROUBLESHOOTING .....	M-5
<b>ELECTRICAL STARTING SYSTEM</b> .....	M-9
CIRCUIT DIAGRAM .....	M-9
STARTING CIRCUIT OPERATION .....	M-10
TROUBLESHOOTING .....	M-10
STARTER MOTOR .....	M-13
<b>CHARGING SYSTEM</b> .....	M-16
CIRCUIT DIAGRAM .....	M-16
TROUBLESHOOTING .....	A-1
<b>LIGHTING SYSTEM</b> .....	A-3
CIRCUIT DIAGRAM .....	A-3
TROUBLESHOOTING .....	A-4
<b>SIGNAL SYSTEM</b> .....	A-6
CIRCUIT DIAGRAM .....	A-6
TROUBLESHOOTING .....	A-7
SIGNAL SYSTEM CHECK .....	A-8
<b>COOLING SYSTEM</b> .....	A-12
CIRCUIT DIAGRAM .....	A-12
TROUBLESHOOTING .....	A-13



ELECTRICAL  
XTZ660 CIRCUIT DIAGRAM

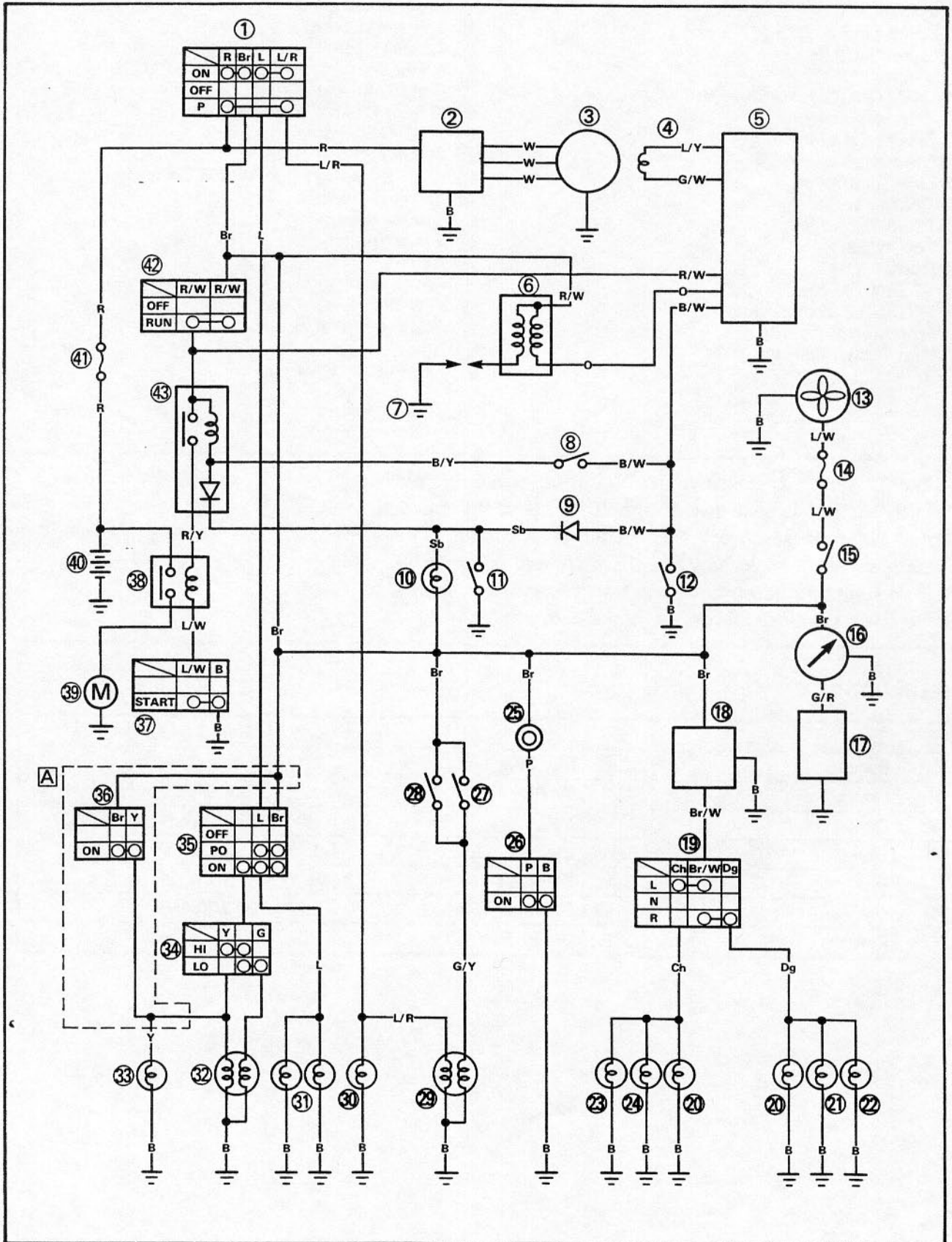





- |                             |  |
|-----------------------------|--|
| ① Main switch               | ②③ Rear flasher light (L)                  |
| ② Rectifier/Regulator       | ②④ Front flasher light (L)                 |
| ③ A.C. magneto genelator    | ②⑤ Horn                                    |
| ④ Pickup coil               | ②⑥ "HORN" switch                           |
| ⑤ Ignitor unit              | ②⑦ Rear brake switch                       |
| ⑥ Ignition coil             | ②⑧ Front brake switch                      |
| ⑦ Spark plug                | ②⑨ Tail/Brake light                        |
| ⑧ Clutch switch             | ②⑩ Auxiliary light                         |
| ⑨ Diode                     | ②⑪ Meter light                             |
| ⑩ "NEUTRAL" indicator light | ②⑫ Head light                              |
| ⑪ Neutral switch            | ②⑬ "HIGH BEAM" indicator light             |
| ⑫ Side stand switch         | ②⑭ "LIGHTS" (dimmer) switch                |
| ⑬ Fan motor                 | ②⑮ "LIGHTS" switch                         |
| ⑭ Fuse (fan motor)          | ②⑯ "PASS" switch (for Austria/Switzerland) |
| ⑮ Thermo switch             | ②⑰ "START" switch                          |
| ⑯ Temperature gauge         | ②⑱ Starter relay                           |
| ⑰ Thermo unit               | ②⑲ Starter motor                           |
| ⑱ Flasher relay             | ②⑳ Battery                                 |
| ⑲ "TURN" switch             | ②㉑ Fuse (main)                             |
| ⑳ "TURN" indicator light    | ②㉒ "ENGINE STOP" switch                    |
| ㉑ Front flasher light (R)   | ②㉓ Starting circuit cut-off relay          |
| ㉒ Rear flasher light (R)    |  |

Ⓐ For Austria/Switzerland

#### NOTE:

- "START" switch is closed while the button (switch) is pushed.
- "HORN" switch is closed while the button (switch) is pused.
- Clutch switch is closed while the clutch lever is pulled.
- Sidestand switch is closed while the sidestand is upped.
- Neutral switch is closed while the transmission is in neutral.
- Brake switch is closed while the brake is applied.

#### COLOR CODE

B	Black	R	Red	G/W	Green/White
Br	Brown	Sb	Sky blue	G/Y	Green/Yellow
Ch	Chocolate	W	White	L/R	Blue/Red
Dg	Dark green	Y	Yellow	L/W	Blue/White
G	Green	B/W	Black/White	L/Y	Blue/Yellow
L	Blue	B/Y	Black/Yellow	R/W	Red/White
O	Orange	Br/W	Brown/White	R/Y	Red/Yellow
P	Pink	G/R	Green/Red		



## ELECTRICAL COMPONENTS

- ① Wireharness
- ② Fuse (cooling fan)
- ③ Diode
- ④ Ignitor unit
- ⑤ Battery
- ⑥ Fuse (main)
- ⑦ Rear brake switch
- ⑧ Ignition coil
- ⑨ Rectifier/Regulator
- ⑩ Main switch

## BATTERY:

CAPACITY: 12V 8AH

SPECIFIC GRAVITY: 1.320

## IGNITION COIL:

PRIMARY COIL RESISTANCE:

3.4 ~ 4.6Ω at 20°C (68°F)

SECONDARY COIL RESISTANCE:

10.4 ~ 15.6kΩ at 20°C (68°F)

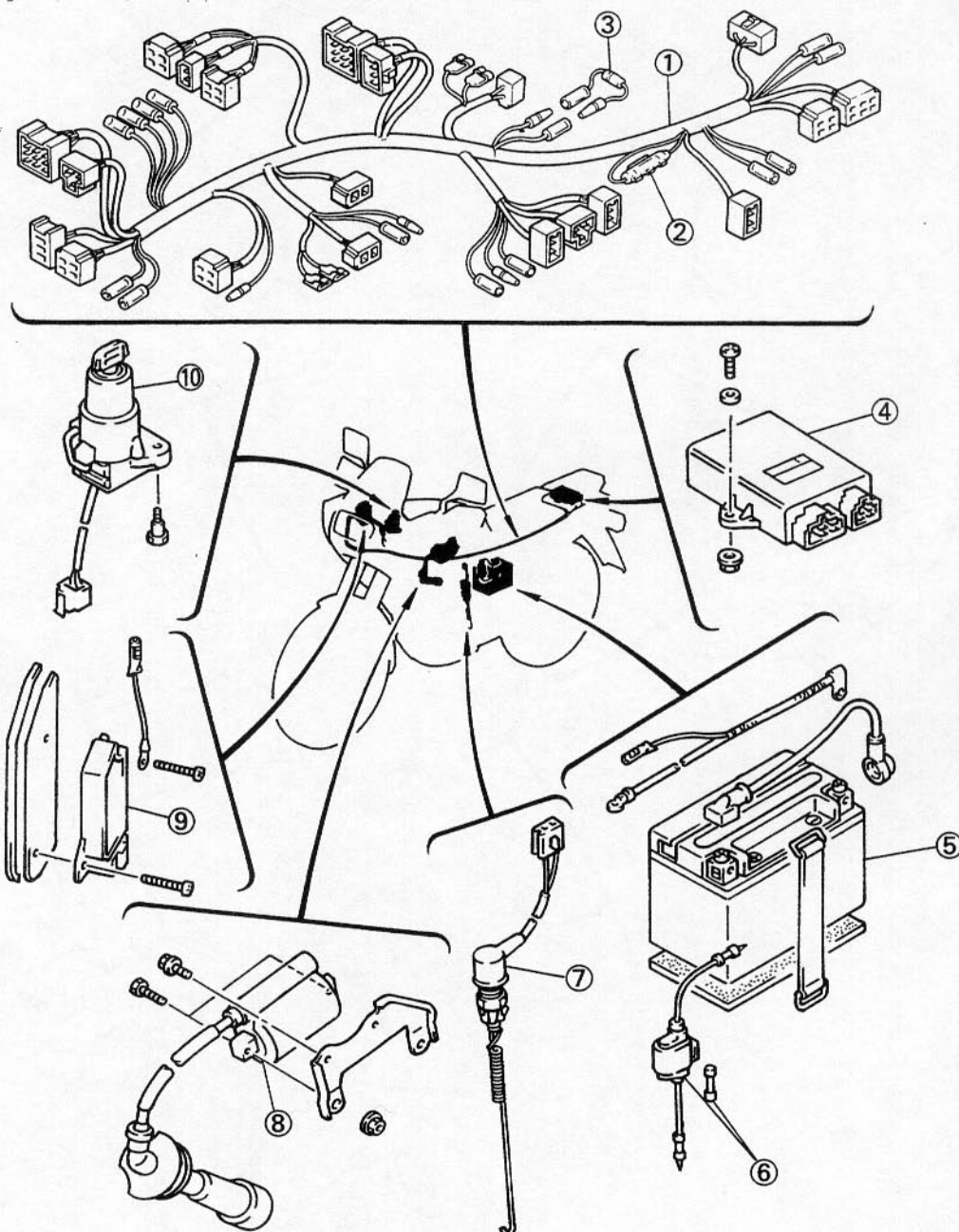



- ① Starter relay
- ② Sidestand switch
- ③ Neutral switch
- ④ Thermo switch
- ⑤ Thermo unit
- ⑥ Horn
- ⑦ Starting circuit cut-off relay
- ⑧ Flasher relay

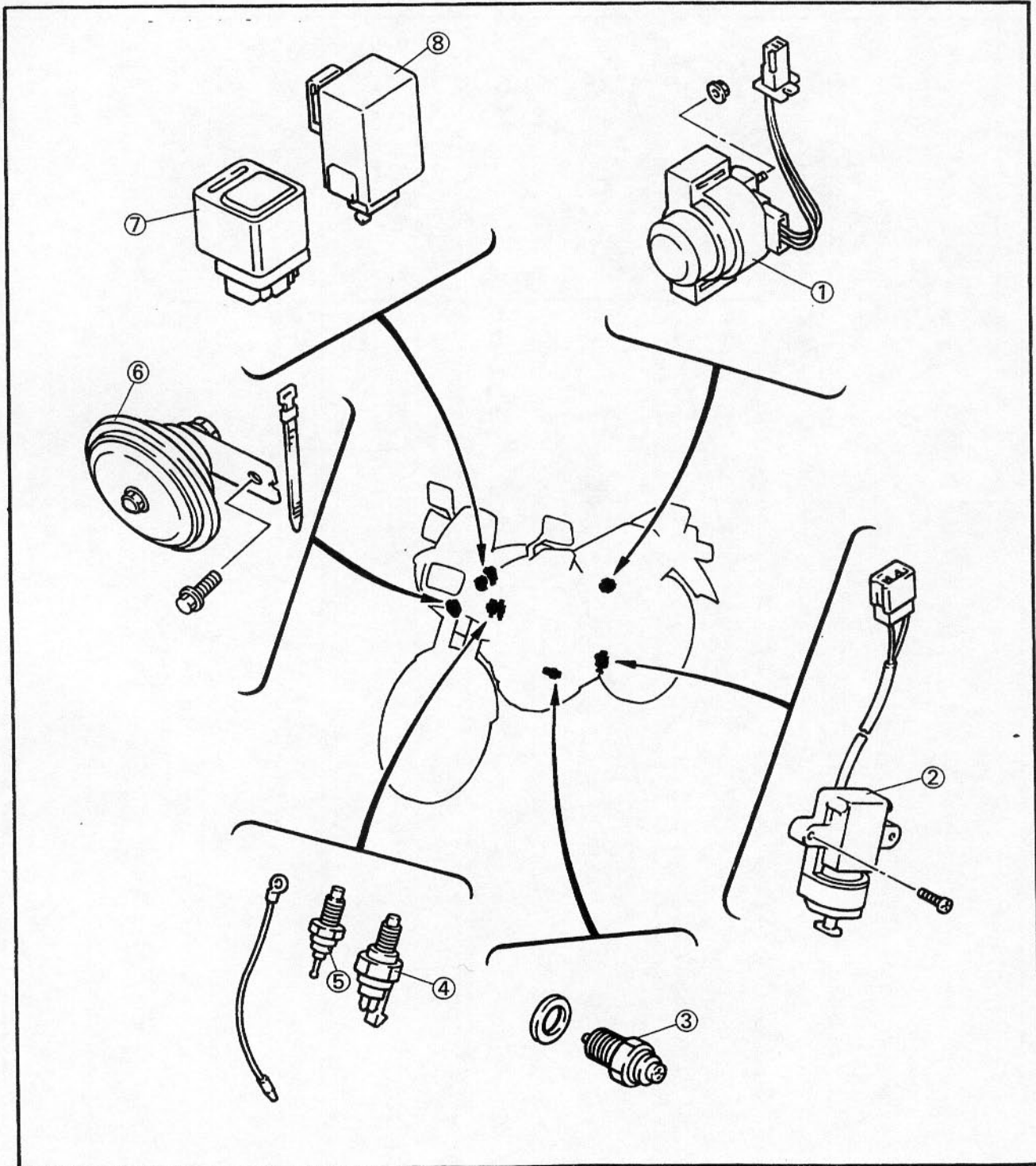



YB281000

**CHECKING OF SWITCHES**

**NOTE:** \_\_\_\_\_

This section is written based on a general model.

Check the switches for the continuity between the terminal to determine correct connection.

Read the following for switch inspection.

YB281001

**SWITCH CONNECTION AS SHOWN IN MANUAL**

The manual contains a connection chart as shown left showing the terminal connections of the switches (e.g., main switch, handlebar switch, bracket switch, lighting switch etc.)

The extreme left column indicates the switch positions and the top line indicates the colors of leads of connected with the terminals in the switch component.

“○—○” indicates the terminals between which there is a continuity of electricity; i.e., a closed circuit at the respective switch positions.

In this chart:

“R” and Br” and “L/W and L/R” are continuous with the “ON” switch position.

“B and B/W” is continuous with the “OFF” switch position.

“B and B/W” is continuous with the “LOCK” switch position.

“B and B/W” and “R and L/R” are continuous with the “P” switch position.

	B	B/W	R	Br	L/W	L/R
ON			○—○		○—○	
OFF	○—○					
LOCK	○—○					
P	○—○		○—○			○—○



YB281002

## CHECKING SWITCH FOR TERMINAL CONNECTION

Before checking the switch, refer to the connection chart as shown above and check for the correct terminal connection (closed circuit) by the color combination.

To explain how to check the switch, the main switch taken for example in the following.

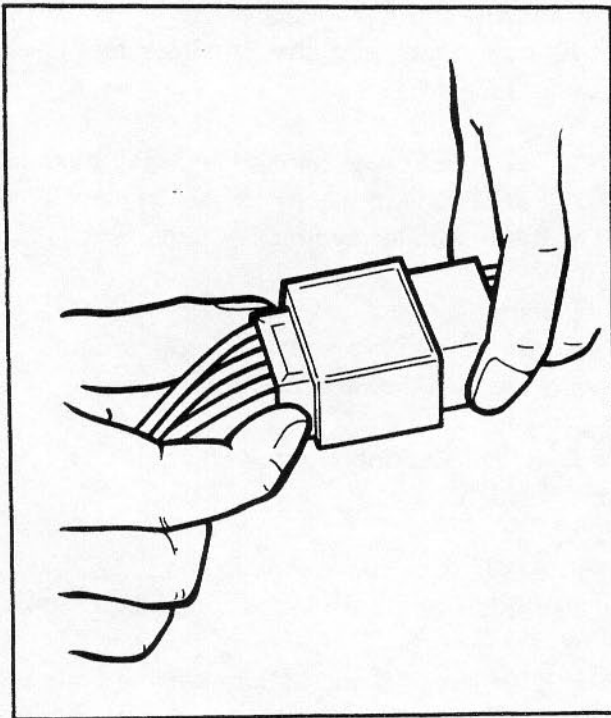

1. Disconnect the main switch coupler from the wireharness.

**CAUTION:** \_\_\_\_\_

**Never disconnect the main switch coupler by pulling the leads. Otherwise, leads may be pulled off the terminals inside the coupler.**

---

2. Inspect whether any lead is off the terminal inside the coupler. If it is, repair it.

**NOTE:** \_\_\_\_\_

If the coupler is clogged with mud or dust, blow it off by compressed air.

---

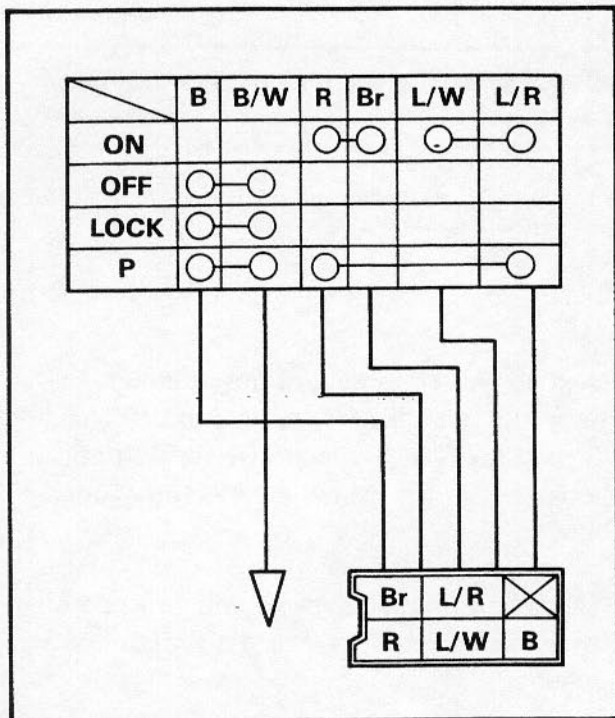

3. Use the connection chart to check the color combination for continuity (a closed circuit). In this example, the continuity is as follows.

“R and Br” and “L/W and L/R” are continuous with the “ON” switch position.

“B” and B/W” is continuous with the “OFF” switch position.

“B and B/W” is continuous with the “LOCK” switch position.

“B and B/W” and “R and L/R” are continuous with the “P” switch position.

Please note that there is no continuity (an open circuit) at all for the color combinations other than the above.

4. Check the switch component for the continuity between “R and Br”.

\*\*\*\*\*

**Checking steps:**

- Turn the switch key to the “ON”, “OFF”, “LOCK” and “P” several times.
- Set the pocket tester selector to the “ $\Omega \times 1$ ”.
- Connect the tester (+) lead to the “R” lead terminal in the coupler and the (-) lead to the “Br” lead terminal.

**NOTE:**

Use thin probes for checking the continuity. Otherwise, the probes may contact other terminals inside the coupler.

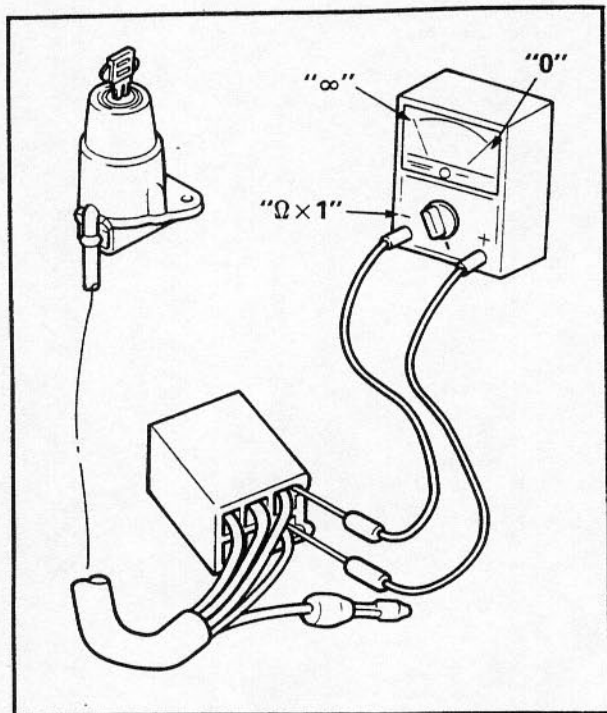

- Check the continuity between “R” and “Br” at the respective switch position of “ON” ①, “OFF” ②, “LOCK” ③, and “P” ④.

There must be continuity (the tester indicating “0”) at the “ON” switch position, and there must be no continuity (the tester indicating  $\infty$ ) at “OFF”, “LOCK”, or “P”.

There is something wrong between “R” and “Br” if there is no continuity at the “ON” position or if there is some continuity either at the

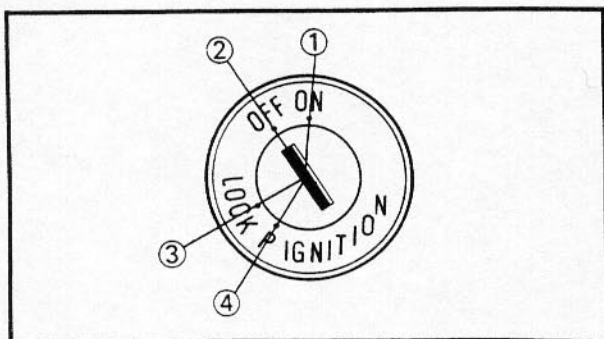





"OFF" or "LOCK" or "P".

**NOTE:** \_\_\_\_\_

Check the switch for continuity several times.

\*\*\*\*\*

5. Next go on to checking of the continuity between "B" and "B/W", "L/W and L/R", and "R and L/R" at the respective switch positions, as in the same manner mentioned above.
6. If there is something wrong with any one of the combinations, replace the switch component.



YB282000

## CHECKING OF BULBS (FOR HEADLIGHT, TAIL/BRAKE LIGHT, FLASHER LIGHT, METER LIGHT, ETC.)

Check the bulb terminal continuity for the condition of the bulb.

YB282001

### KINDS OF BULBS

The bulbs used in the motorcycle are classified as shown left by the shape of the bulb socket.

Ⓐ and Ⓑ are mainly used for the headlight.

Ⓒ is mainly used for the flasher light and tail/brake light.

Ⓓ and Ⓔ are mainly used for the meter light and other indicator lights.

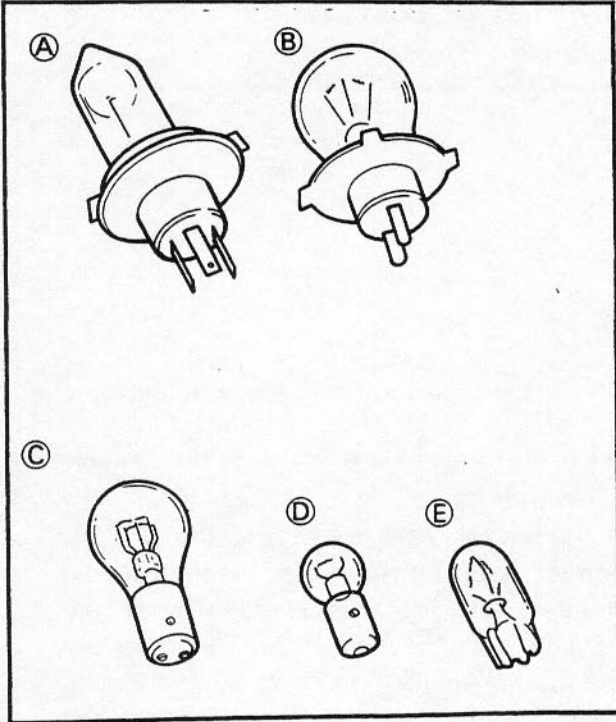

YB282002

### CHECKING BULB CONDITION

1. Remove the bulb

#### NOTE:

- Bulbs of the Ⓐ and Ⓑ type uses a bulb holder. Remove the bulb holder before removing the bulb itself. Most of the bulb holder for this type can be removed by turning them counterclockwise.
- Most of the bulbs of Ⓒ and Ⓓ type can be removed from the bulb sockets by pushing and turning them counterclockwise.
- Bulbs of the Ⓔ type can be removed from the bulb sockets by simply pulling them out.

### CAUTION:

Be sure to hold the socket firmly when removing the bulb. Never pull the lead. Otherwise, the lead may be pulled off the terminal in the coupler.

### WARNING

Keep flammable products or your hands away from the headlight bulb while it is on. It will be hot. Do not touch the bulb until it cools down.

2. Check the bulb terminals for continuity.

\*\*\*\*\*

#### Checking steps:

- Set the pocket tester selector to the " $\Omega \times 1$ ".
- Connect the tester lead to the respective bulb terminals. Take for example a 3-terminal bulb as shown left. First check the continuity between the ① and ② terminal by connecting the tester (+) lead to the ① terminal and the tester (-) lead to the ② terminal. Then check the continuity between the ① and ③ terminals by connecting the tester (+) lead still to the ① terminal and the tester (-) lead to the ③ terminal. If the tester shown " $\infty$ " in either case, replace the bulb.

\*\*\*\*\*

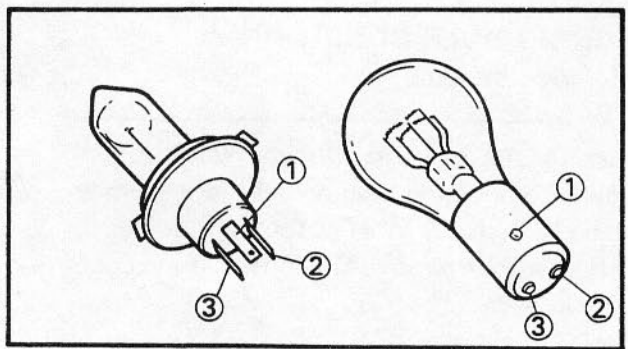

3. Check the bulb socket by installing a proven bulb to it. As in the checking of bulbs, connect the pocket tester leads to the respective leads of the socket and check for continuity in the same manner as mentioned above.





### IGNITION SYSTEM

#### CIRCUIT DIAGRAM

Below circuit diagram shows ignition system.

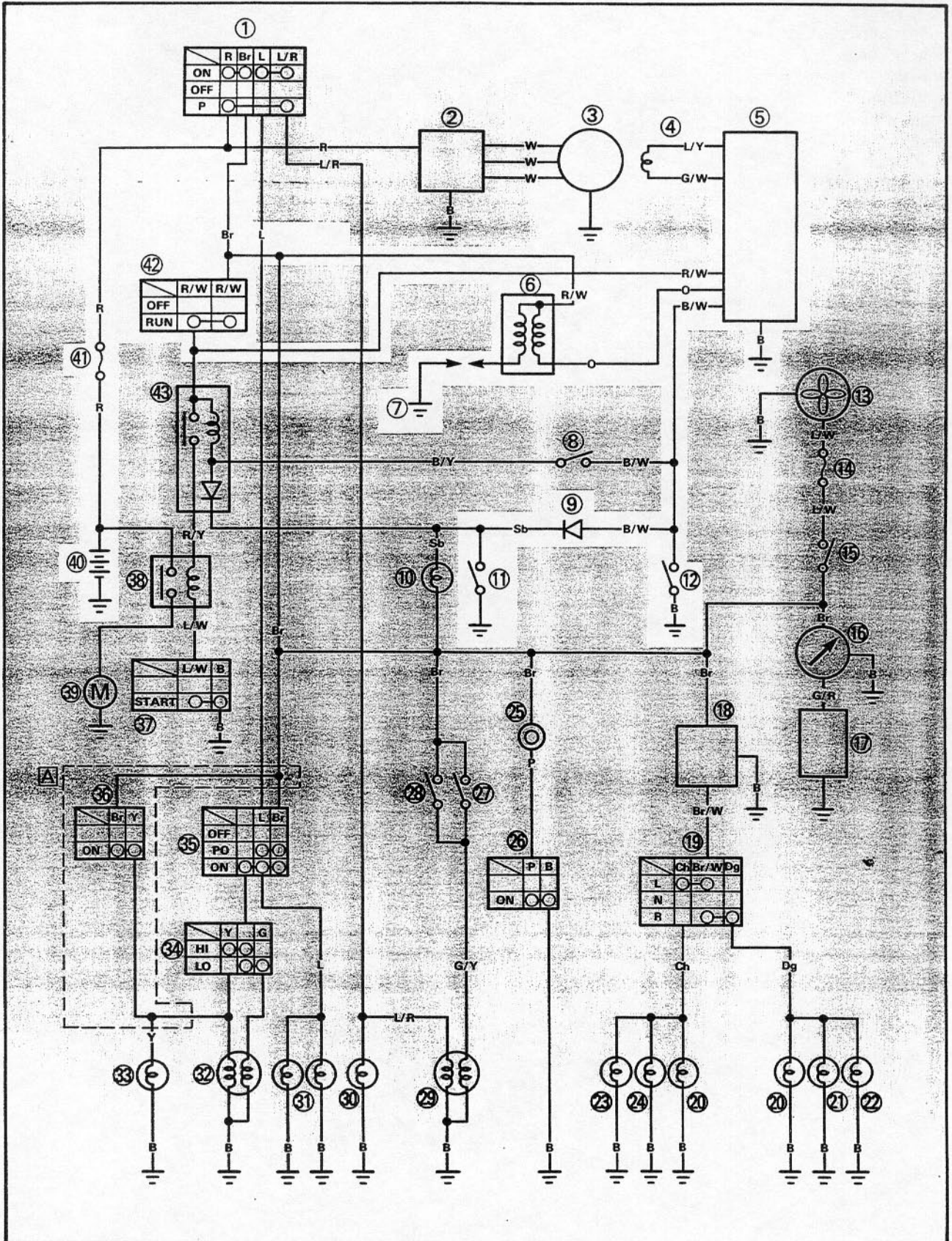



**NOTE:** \_\_\_\_\_

For the color codes, see page 8-2.

- ① Main switch
- ③ A.C. magneto
- ④ Pickup coil
- ⑤ Ignitor unit
- ⑥ Ignition coil
- ⑦ Spark plug
- ⑨ Diode
- ⑪ Neutral switch
- ⑫ Sidestand switch
- ④① Battery
- ④① Fuse (main)
- ④② "ENGINE STOP" switch

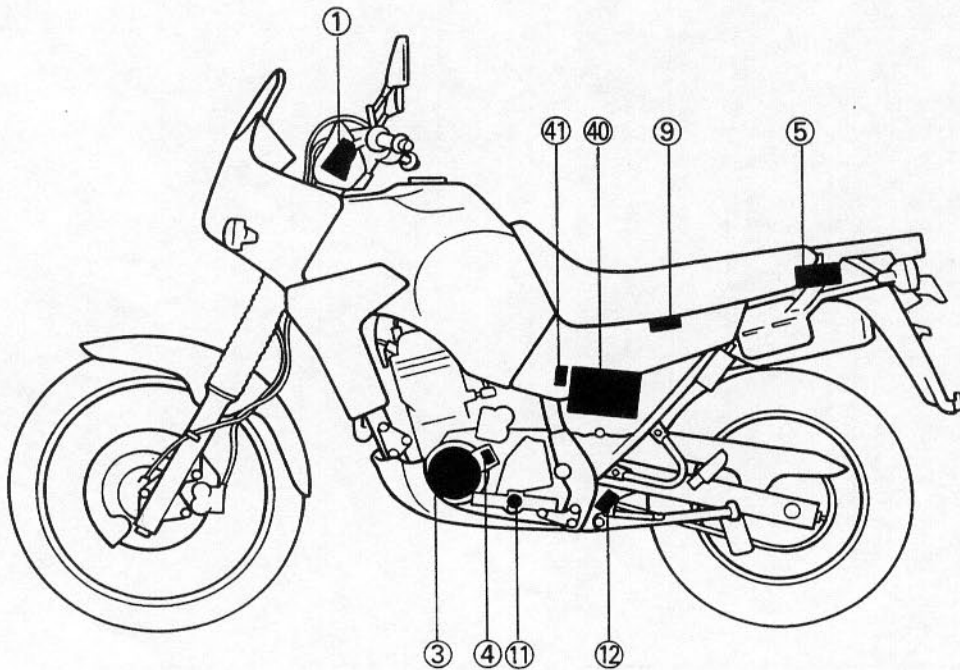
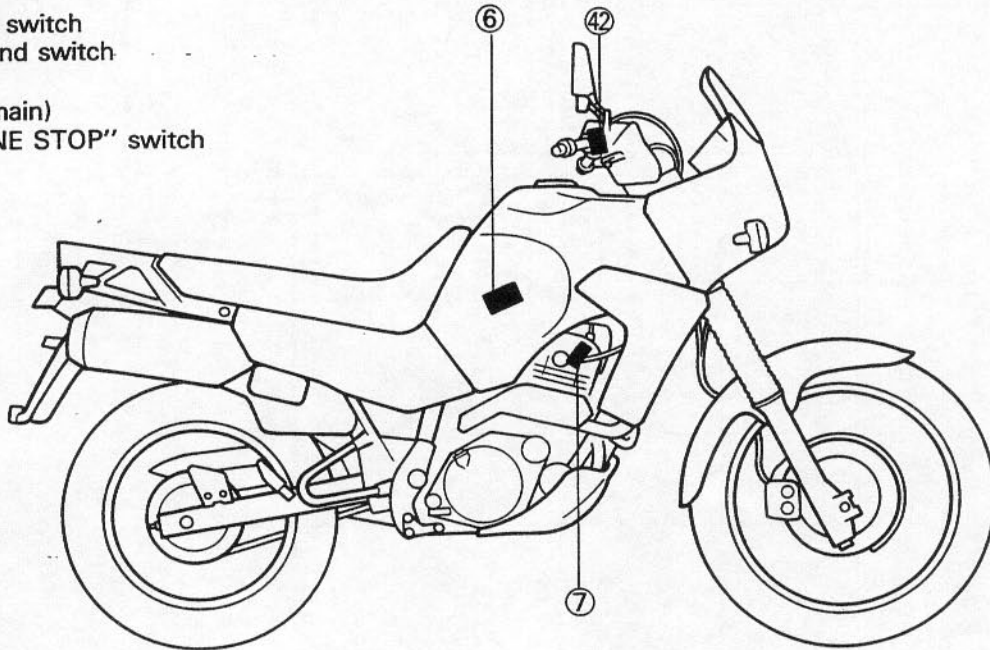



### TROUBLESHOOTING

#### IF IGNITION SYSTEM SHOULD BECOME INOPERATIVE (NO SPARK OR INTERMITTENT SPARK)

#### Procedure

#### Check:

- |                              |   |
|------------------------------|---|
| 1. Fuse (main)               | 8. "ENGINE STOP" switch                           |
| 2. Battery                   | 9. Neutral switch                                 |
| 3. Spark plug                | 10. Sidestand switch                              |
| 4. Ignition spark gap        | 11. Diode   |
| 5. Spark plug cap resistance | 12. Pickup coil resistance                        |
| 6. Ignition coil resistance  | 13. Wiring connection<br>(Entire ignition system) |
| 7. Main switch               |   |

#### NOTE:

•Remove the following parts before troubleshooting.

- |                |              |
|----------------|--------------|
| 1) Seat        | 4) Fuel tank |
| 2) Side covers |              |
| 3) Air scoops  |              |

•Use the following special tools in this troubleshooting.



**Dynamic spark tester:**  
P/N YM-34487  
**Ignition checker:**  
P/N. 90890-06754



**Pocket tester:**  
P/N YU-03112, 90890-03112

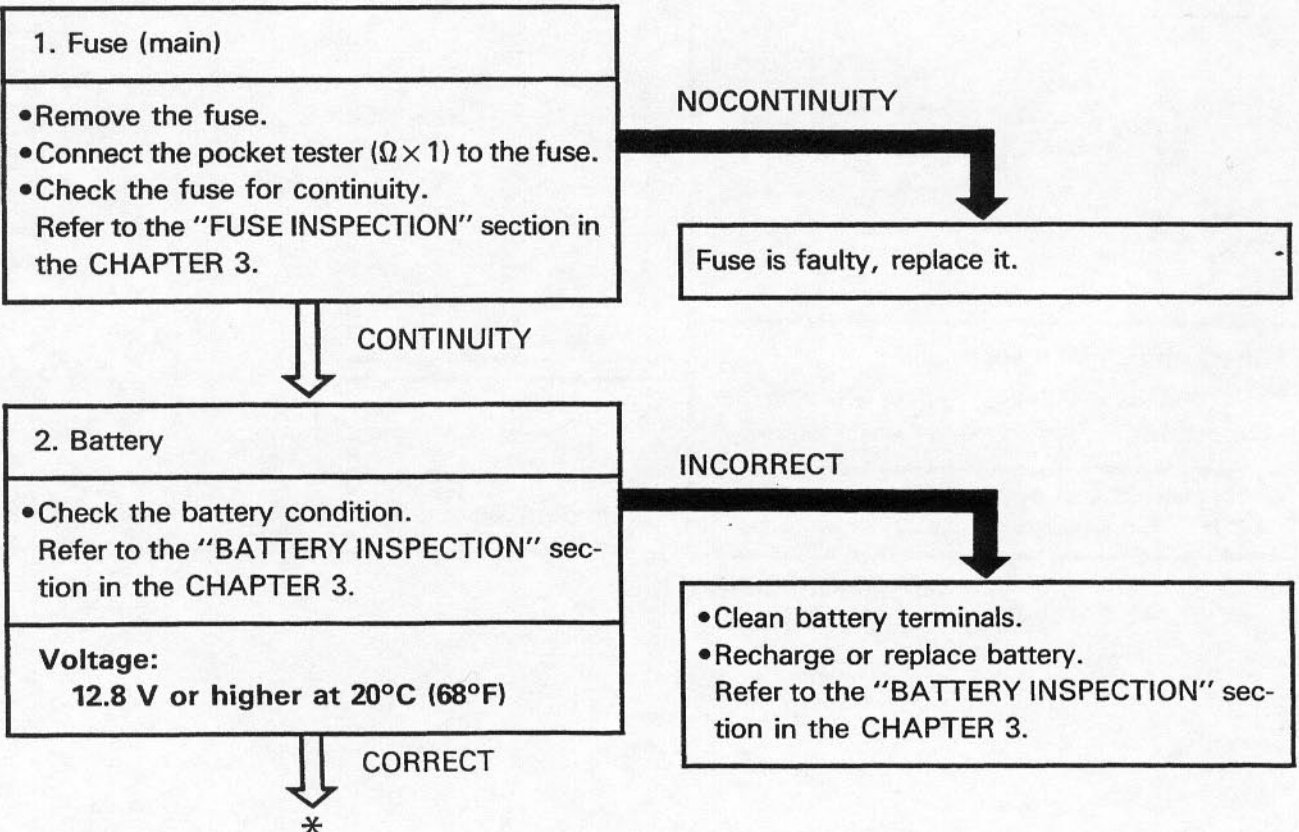





**3. Spark plug**

- Check the spark plug condition.
- Check the spark plug type.
- Check the spark plug gap.

Refer to the "SPARK PLUG INSPECTION" section in the CHAPTER 3.

**Standard spark plug:  
DPR8EA-9, DPR9EA-9 (NGK)**

**Spark plug gap:  
0.8~0.9 mm (0.031~0.035 in)**

INCORRECT

Spark plug is faulty, replace it or repair plug gap.

CORRECT

**4. Ignition spark gap**

- Disconnect the spark plug cap from spark plug.
- Connect the ignition checker ① as shown.
- ② Spark plug cap
- ③ Spark plug
- Turn the main switch to "ON".

- Check the ignition spark gap.
- Start engine, and increase spark gap until misfire occurs.

**Minimum spark gap:  
6.0 mm (0.24 in)**

MEETS SPECIFICATION

Ignition system is good.

OUT OF SPECIFICATION  
OR NO SPARK





5. Spark plug cap resistance

- Remove the spark plug cap.
- Connect the pocket tester ( $\Omega \times 1k$ ) to the spark plug cap.

- Check the spark plug cap for specified resistance.

 **Spark plug cap resistance:**  
**10 k $\Omega$  at 20°C (68°F)**

OUT OF SPECIFICATION

Spark plug cap is faulty, replace it.

MEETS SPECIFICATION

6. Ignition coil resistance

- Disconnect the ignition coil leads from the ignition coil.
- Connect the pocket tester ( $\Omega \times 1$ ) to the ignition coil.

**Tester (+) lead  $\rightarrow$   $\oplus$  terminal**  
**Tester (-) lead  $\rightarrow$   $\ominus$  terminal**

- Check the primary coil for specified resistance.

 **Primary coil resistance:**  
**3.4 ~ 4.6 $\Omega$  at 20°C (68°F)**  
**( $\oplus$  terminal -  $\ominus$  terminal)**



- Connect the pocket tester ( $\Omega \times 1\text{ k}$ ) to the ignition coil.

Tester (+) lead  $\rightarrow$  Spark plug lead ①  
 Tester (-) lead  $\rightarrow$   $\oplus$  terminal

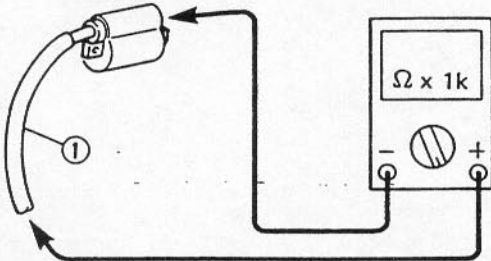

- Check the secondary coil for specified resistance.



**Secondary coil resistance:**  
 10.4 ~ 15.6k $\Omega$  at 20°C (68°F)  
 (Spark plug lead -  $\oplus$  terminal)

BOTH MEET SPECIFICATIONS

Ignition coil is faulty, replace it.

### 7. Main switch

- Disconnect the main switch coupler from the wire harness.
- Check the switch component for the continuity between "Red ① and Brown ②". Refer to the "CHECKING OF SWITCHES" section.

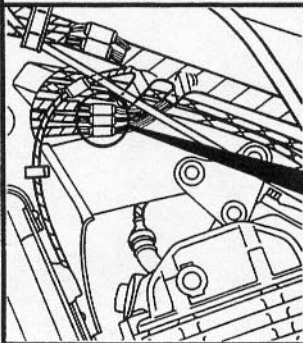

	R	Br	L	L/R
ON	○	○	○	○
OFF				
LOCK				
P	○			○

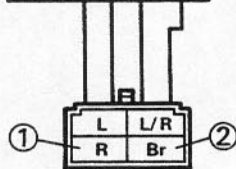

INCORRECT

Main switch is faulty, replace it.

CORRECT

\*





**8. "ENGINE STOP" switch**

- Disconnect the handlebar switch (right) coupler from the wireharness.
- Check the switch component for the continuity between "Red/White ① and Red/White ②". Refer to the "CHECKING OF SWITCHES" section.

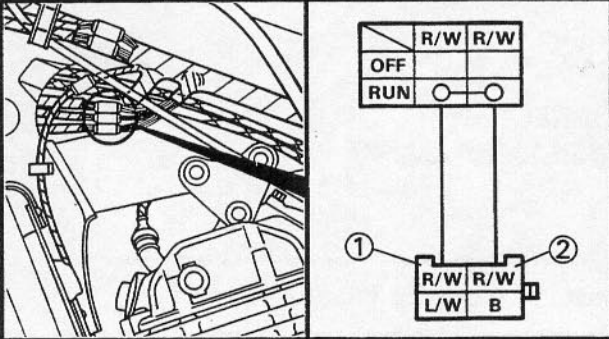

The diagram shows a switch component with two terminals labeled ① and ②. Terminal ① is connected to a Red/White (R/W) wire, and terminal ② is connected to another Red/White (R/W) wire. The switch has two positions: OFF and RUN. The OFF position shows a break in the circuit between the two R/W wires. The RUN position shows a closed circuit between the two R/W wires. Below the switch, there are labels R/W, R/W, L/W, and B.

INCORRECT

"ENGINE STOP" switch is faulty, replace handlebar switch (right).

CORRECT

**9. Neutral switch**

- Disconnect the neutral switch lead from the wireharness.
- Check the switch component for the continuity between "Sky blue ① and ground". Refer to the "CHECKING OF SWITCHES" section.

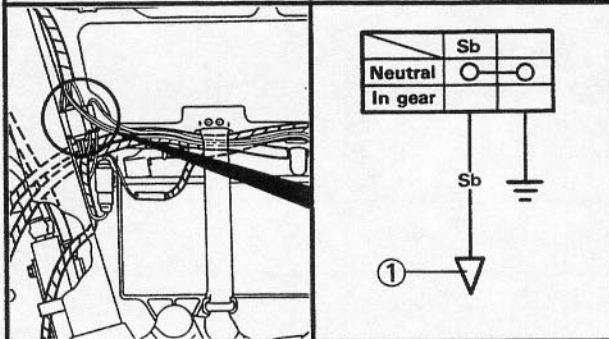

The diagram shows a switch component with two terminals. One terminal is labeled ① and is connected to a Sky blue (Sb) wire. The other terminal is connected to ground. The switch has two positions: Neutral and In gear. The Neutral position shows a closed circuit between the Sb wire and ground. The In gear position shows a break in the circuit between the Sb wire and ground.

INCORRECT

Neutral switch is faulty, replace it.

CORRECT





10. Sidestand switch

- Disconnect the sidestand switch coupler from the wireharness.
- Check the switch component for the continuity between "Black/White ① and Black ②". Refer to the "CHECKING OF SWITCHES" section.

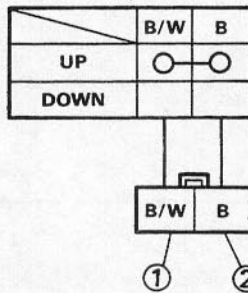
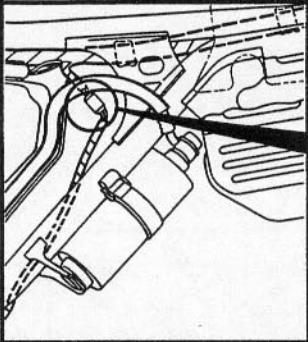

INCORRECT

Sidestand switch is faulty, replace it.

CORRECT

11. Diode

- Disconnect the diode leads from the wireharness.
- Connect the pocket tester ( $\Omega \times 1$ ) to the diode.

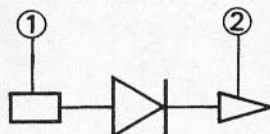
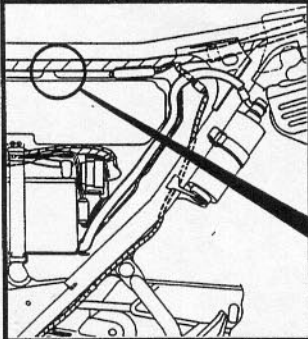

BAD CONDITION

Diode is faulty, replace it.

- Check the diode for continuity.

Pocket tester connecting point		Good	Bad		
(+) lead	(-) lead				
②	①	○	○	×	×
①	②	×	○	×	○

○: Continuity    ×: Nocontinuity

GOOD CONDITION





12. Pickup coil resistance

- Disconnect the pickup coil coupler from the wireharness.
- Connect the pocket tester ( $\Omega \times 100$ ) to the pickup coil terminal.

Tester (+) lead → Green/White lead ①  
 Tester (-) lead → Blue/Yellow lead ②

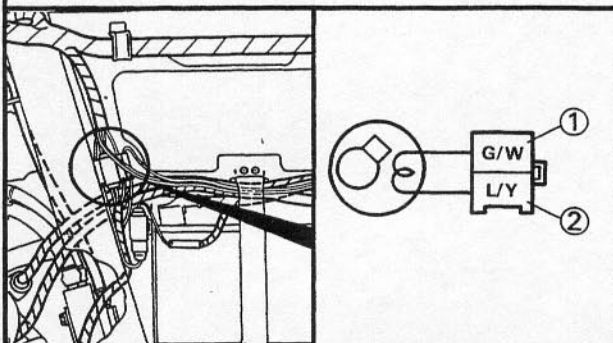

- Check the pickup coil for specified resistance.



**Pickup coil resistance:**  
 184 ~ 276 $\Omega$  at 20°C (68°F)  
 (Green/White – Blue/Yellow)

OUT OF SPECIFICATION

Pickup coil is faulty, replace it.

MEET SPECIFICATION

13. Wiring connection

Check the entire ignition system for connections.  
 Refer to the "WIRING DIAGRAM" section.

POOR CONNECTION

Correct.

CORRECT

Replace the ignitor unit.





ELECTRICAL STARTING SYSTEM

CIRCUIT DIAGRAM

Below circuit diagram shows electrical starting system.

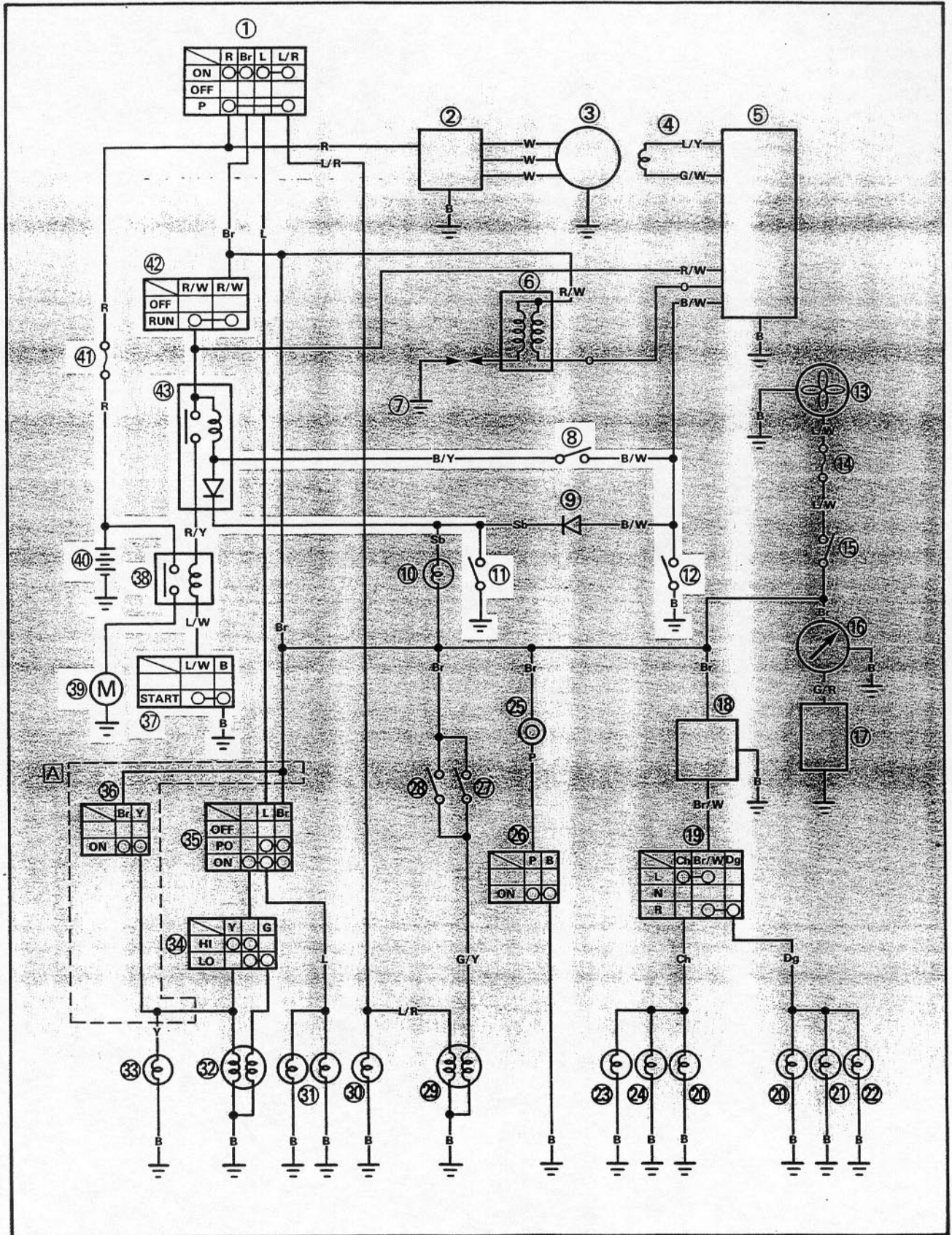



**NOTE:** \_\_\_\_\_

For the color codes, see page 8-2.

- ① Main switch
- ⑧ Clutch switch
- ⑪ Neutral switch
- ⑫ Sidestand switch
- ⑳ "START" switch
- ㉑ Starter relay
- ㉒ Starter motor
- ㉓ Battery
- ㉔ Fuse (main)
- ㉕ "ENGINE STOP" switch
- ㉖ Starting circuit cut-off relay

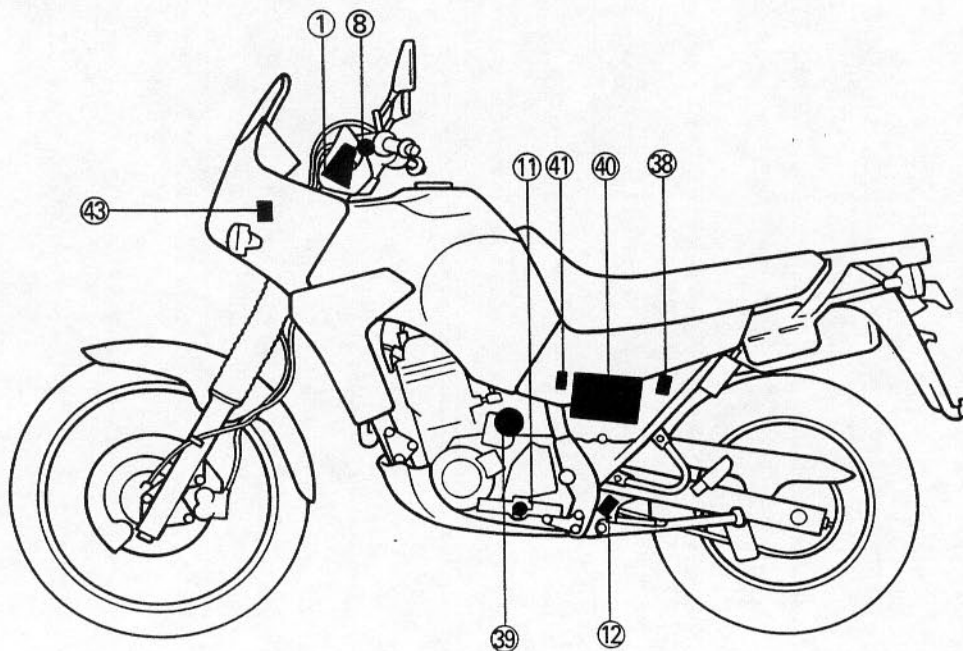
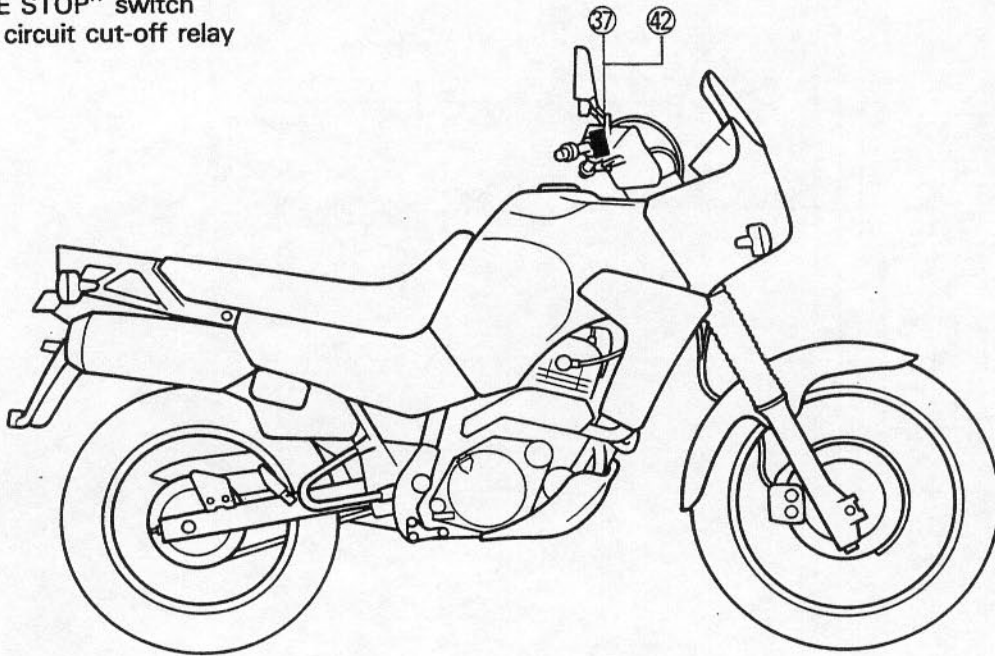



YB284001

## STARTING CIRCUIT OPERATION

The starting circuit on this model consist of the starter motor, starter relay, and the relay unit (starting circuit cut-off relay). If the "ENGINE STOP" switch and the main switch are both closed, the starter motor can operate only if:

The transmission is in neutral (the neutral switch is closed).

or if

The clutch lever is pulled to the handlebar (the clutch switch is closed) and the sidestand is up (the sidestand switch is closed).

The starting circuit cut-off relay prevents the starter from operating when neither of these conditions has been met. In this instance, the starting circuit cut-off relay is open so current cannot reach the starter motor.

When one of both of the above conditions have been met, however, the starting circuit cut-off relay is closed, and the engine can be started by pressing the starter switch.

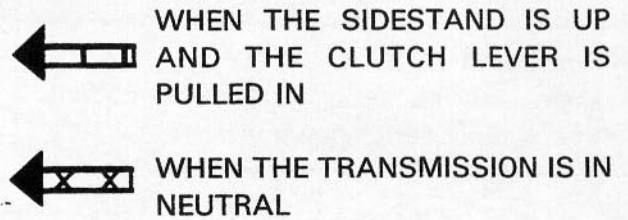

- ① Battery
- ② Main switch
- ③ "ENGINE STOP" switch
- ④ Starting circuit cut-off relay
- ⑤ "START" switch
- ⑥ Starter relay
- ⑦ Starter motor
- ⑧ Neutral switch
- ⑨ Sidestand switch
- ⑩ Clutch switch

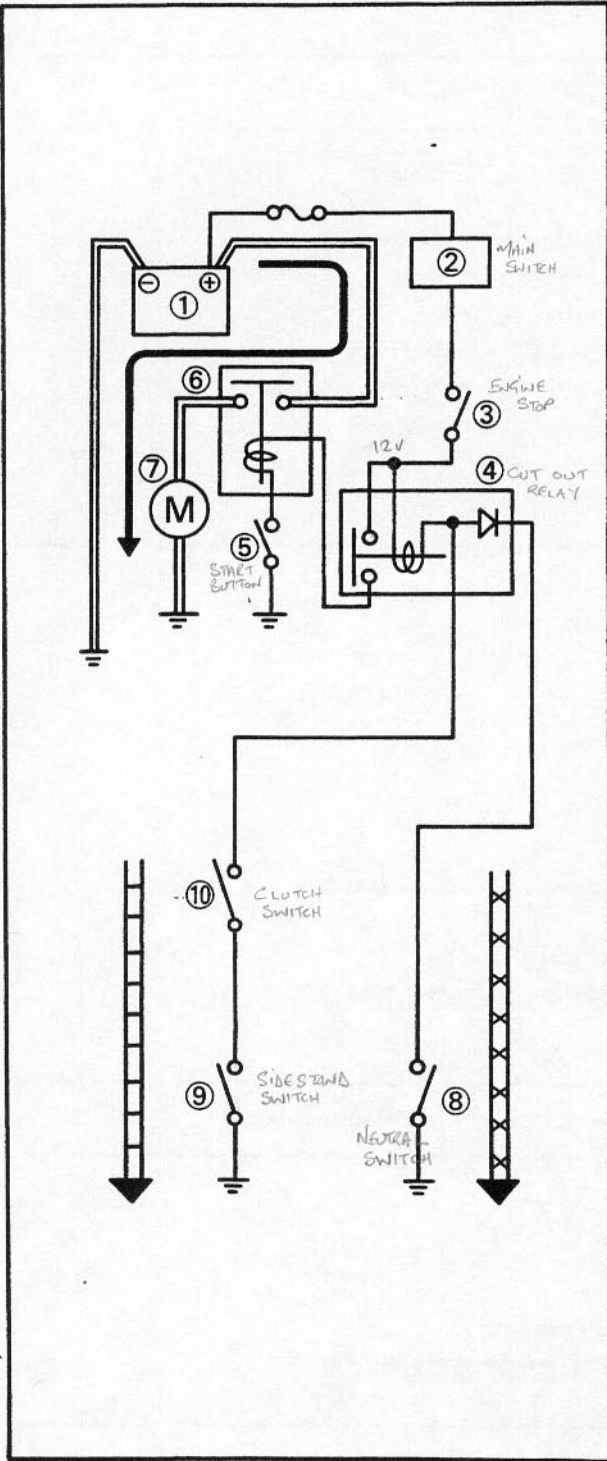





## TROUBLESHOOTING

### STARTER MOTOR DOES NOT OPERATE.

**Procedure**

Check:

- |  |  |
|--|--|
| <ol style="list-style-type: none"> <li>1. Fuse (main)</li> <li>2. Battery</li> <li>3. Starter motor</li> <li>4. Starter relay</li> <li>5. Starting circuit cut-off relay</li> <li>6. Main switch</li> <li>7. "ENGINE STOP" switch</li> </ol> | <ol style="list-style-type: none"> <li>8. Neutral switch</li> <li>9. Sidestand switch</li> <li>10. Clutch switch</li> <li>11. "START" switch</li> <li>12. Wiring connection<br/>(Entire electric starting system)</li> </ol> |
|--|--|

**NOTE:**

- Remove the following parts before troubleshooting.
 

1) Seat	4) Fuel tank
2) Side covers	
3) Air scoops	
- Use the following special tool in this troubleshooting.

**Pocket tester:**  
P/N YM-03112, 90890-03112

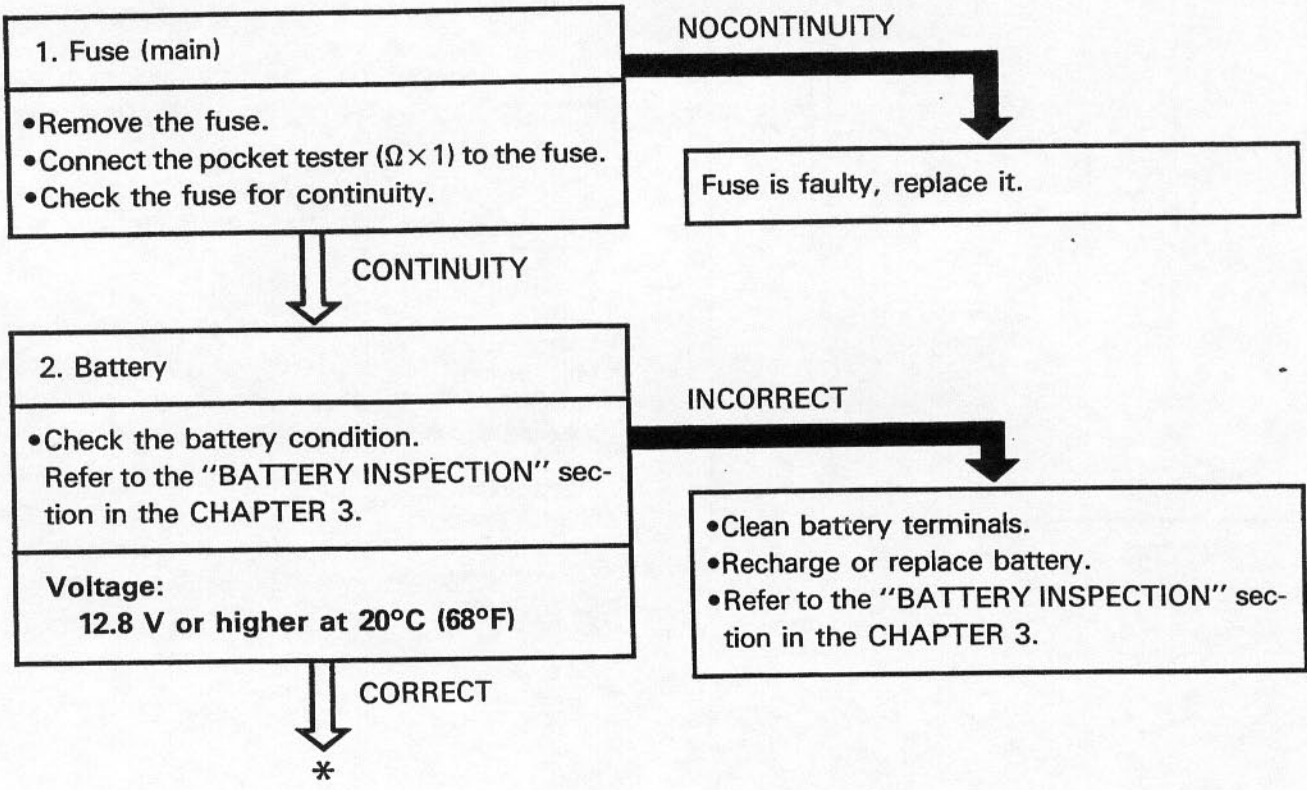



**3. Starter motor**

- Connect the battery positive terminal ① and starter motor cable ② using a jumper lead ③ \* as shown.

- Check the starter motor for operation.

\*

**⚠ WARNING**

- A wire for the jumper lead must have the equivalent capacity as that of the battery lead or more, otherwise it may cause the jumper lead to be burned.
- This check is likely to produce sparks, so be sure that no flammable gas or fluid is in the vicinity.

DOES NOT MOVE

Starter motor is faulty, repair or replace it.



MOVES

**4. Starter relay**

- Disconnect the starter relay coupler from the wireharness.
- Connect the battery to the starter relay leads as shown using the jumper leads ①.

- Check the starter motor for operation.

DOES NOT MOVE

Starter relay is faulty, replace it.



MOVES

**5. Starting circuit cut-off relay**

- Disconnect the starting circuit cut-off relay from the wireharness.
- Connect the pocket tester ( $\Omega \times 1$ ) and battery (12V) to the starting circuit cut-off relay.

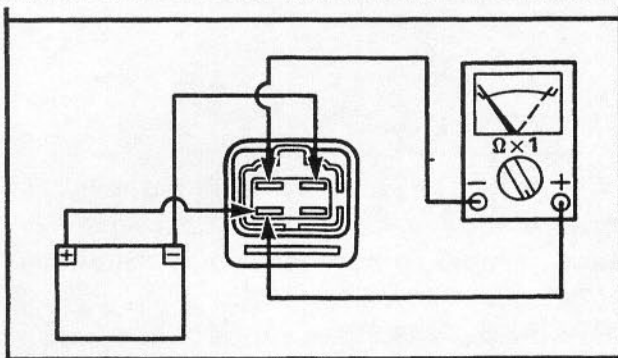

• Check the starting circuit cut-off relay for continuity.

NOCONTINUITY

Starting circuit cut-off relay is faulty, replace it.

CONTINUITY

### 6. Main switch

• Disconnect the main switch coupler from the wireharness.  
 • Check the switch component for the continuity between "Red ① and Brown ②". Refer to the "CHECKING OF SWITCHES" section.

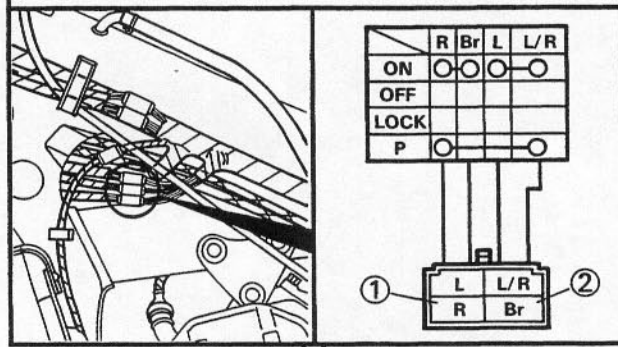

INCORRECT

Main switch is faulty, replace it.

CORRECT

### 7. "ENGINE STOP" switch

• Disconnect the handlebar switch (right) coupler from the wireharness.  
 • Check the switch component for the continuity between "Red/White ① and Red/White ②". Refer to the "CHECKING OF SWITCHES" section.

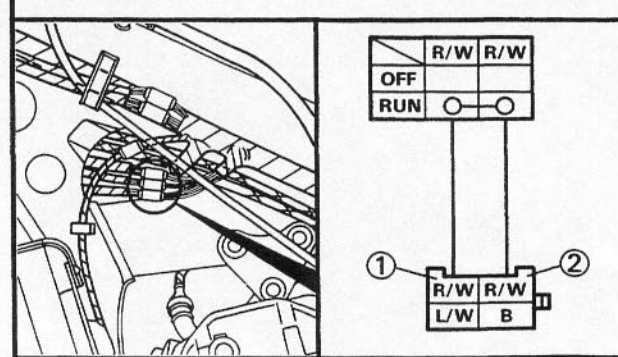

INCORRECT

"ENGINE STOP" switch is faulty, replace handlebar switch (right).

CORRECT

\*





### 8. Neutral switch

- Disconnect the neutral switch lead from the wireharness.
- Check the switch component for the continuity between "Sky blue ① and Ground". Refer to the "CHECKING OF SWITCHES" section.

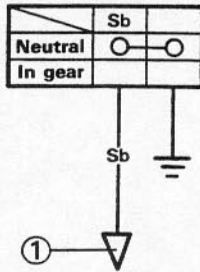
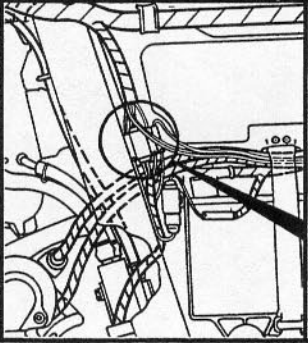

INCORRECT

Neutral switch is faulty, replace it.

CORRECT

### 9. Sidestand switch

- Disconnect the sidestand switch coupler from the wireharness.
- Check the switch component for the continuity between "Black/White ① and Black ②". Refer to the "CHECKING OF SWITCHES" section.

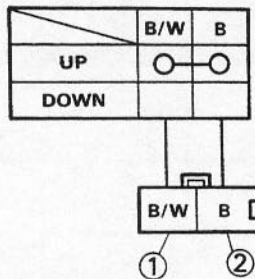
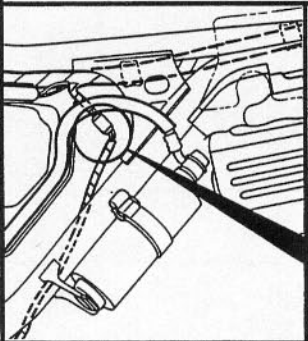

INCORRECT

Sidestand switch is faulty, replace it.

CORRECT

### 10. Clutch switch

- Disconnect the clutch switch coupler from the wireharness.
- Check the clutch switch component for the continuity between "Black/Yellow ① and Black ②". Refer to the "CHECKING OF SWITCHES" section.

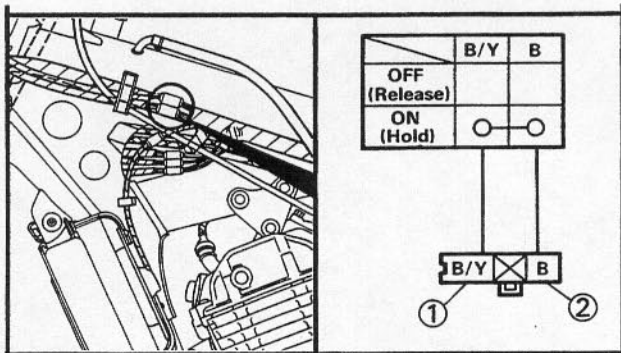

INCORRECT

Clutch switch is faulty, replace it.

CORRECT

11. "START" switch

- Disconnect handlebar switch (right) coupler from wireharness.
- Check the "START" switch component for the continuity between "Blue/White ① and Black ②". Refer to the "CHECKING OF SWITCHES" section.

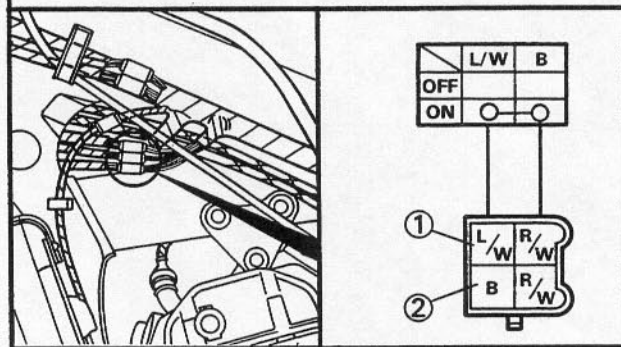

INCORRECT

"START" switch is faulty, replace handlebar switch (right).

CORRECT

12. Wiring connection

Check the entire ignition system for connections.  
Refer to the "WIRING DIAGRAM" section.

POOR CONNECTION

Correct.

**STARTER MOTOR**

- ① O-ring
- ② Armature
- ③ O-ring
- ④ Yoke
- ⑤ O-ring
- ⑥ Brush

A	<b>BRUSH WEAR LIMIT:</b> 5.0 mm (0.20 in)
B	<b>COMMUTATOR WEAR LIMIT:</b> 27 mm (1.06 in)
C	<b>MICA UNDERCUT:</b> 0.7 mm (0.027 in)
D	<b>ARMATURE COIL RESISTANCE:</b> 0Ω at 20°C (68°F)

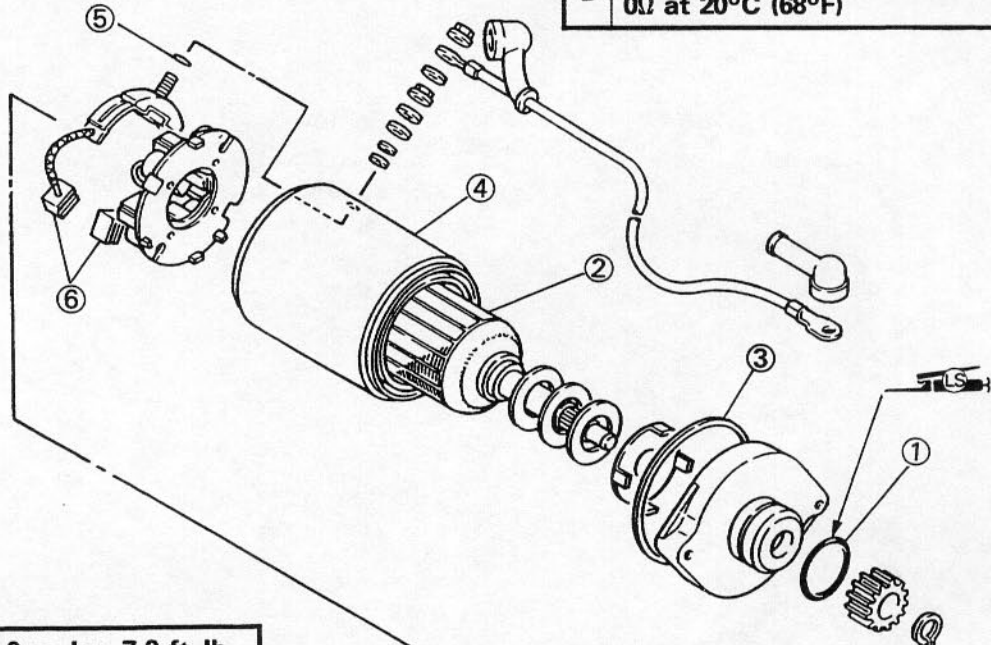

**10 Nm (1.0 m•kg, 7.2 ft•lb)**

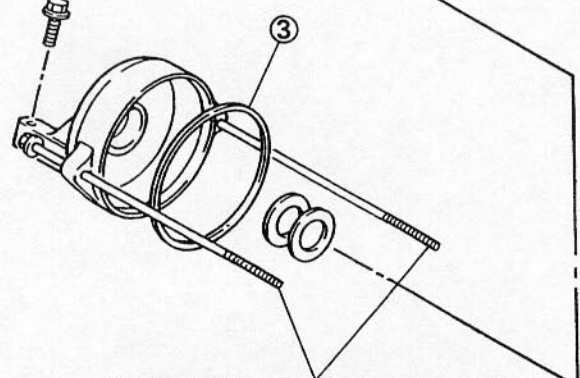

**5 Nm (0.5 m•kg, 3.6 ft•lb)**





YB284002

## Removal

### 1. Remove:

- Starter motor

Refer to the "ENGINE OVERHAUL—ENGINE DISASSEMBLY" section in the CHAPTER 4.

## Disassembly

### 1. Put identifying marks ① on the brackets for reassembly as shown.

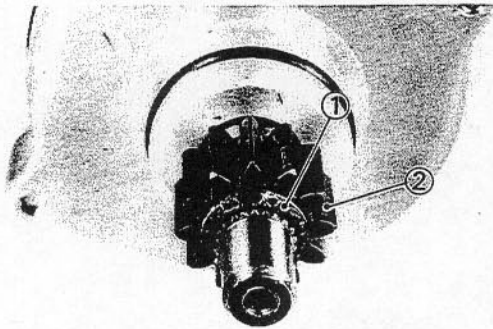
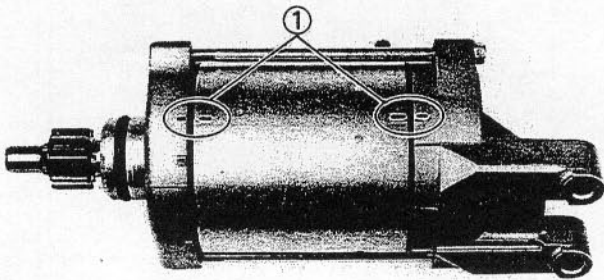

### 2. Remove:

- Circlip ①
- Starter drive gear ②

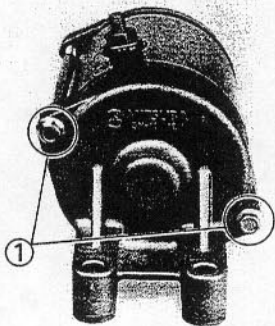

### 3. Remove:

- Bolts ①



4. Remove:

- Bracket ①
- Washers ②
- Shims ③
- Bracket ④
- Shims ⑤
- Armature ⑥
- O-rings ⑦
- Yoke ⑧

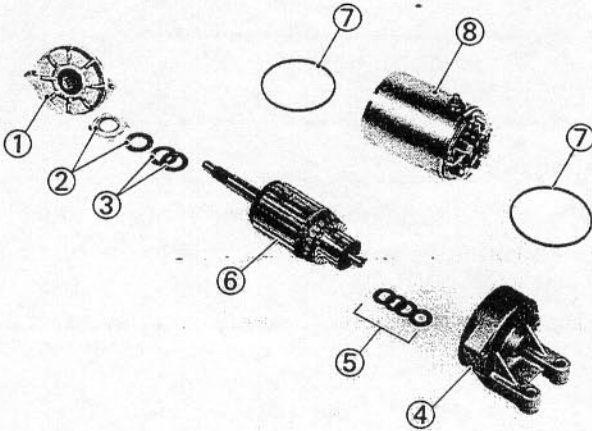

5. Remove:

- Brush holder set ①

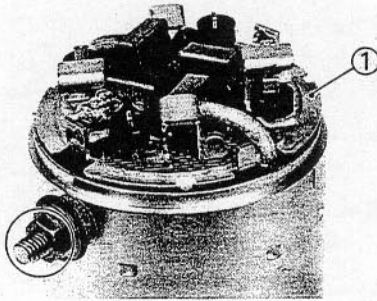

### Inspection and repair

1. Inspect:

- Commutator
- Dirty → Clean it with #600 grit sandpaper.

2. Measure:

- Commutator diameter (a)
- Out of specification → Replace starter motor.

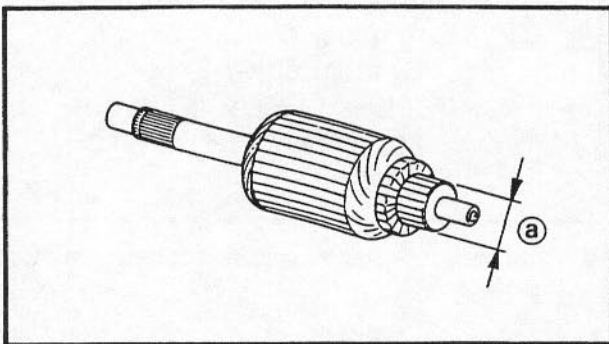

	<p><b>Commutator wear limit:</b> 27 mm (1.06 in)</p>
--	--

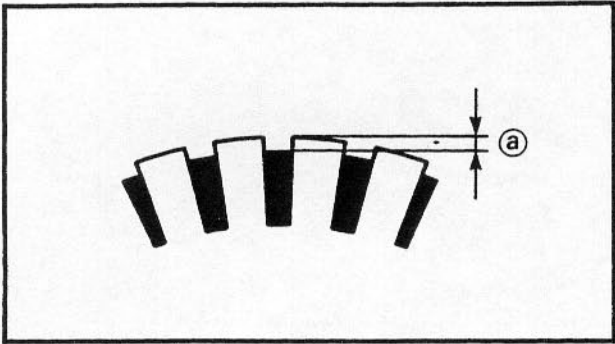

3. Measure:

- Mica undercut (a)  
Out of specification → Scrape the mica to proper value use a hacksaw blade can be ground to fit.

 **Mica undercut:**  
0.7 mm (0.028 in)

**NOTE:** \_\_\_\_\_  
The mica insulation of the commutator must be undercut to ensure proper operation of commutator.

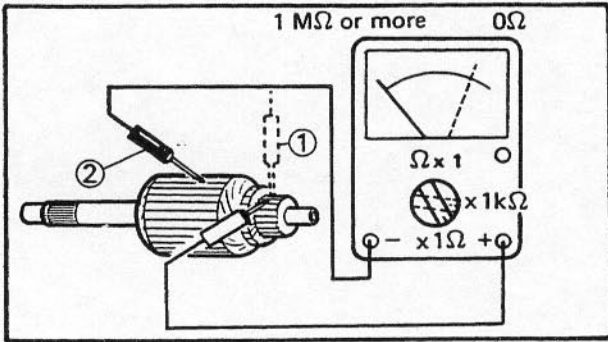

4. Inspect:

- Armature coil (insulation/continuity)  
Defects → Replace starter motor.

\*\*\*\*\*

**Inspecting steps:**

- Connect the pocket tester for continuity check (1) and insulation check (2).
- Measure the armature resistances.

 **Armature coil resistance:**  
Continuity check (1):  
0Ω at 20°C (68°F)  
Insulation check (2):  
More than 1MΩ at 20°C (68°F)

- If the resistance is incorrect, replace the starter motor.

\*\*\*\*\*

5. Measure:

- Brush length (a)  
Out of specification → Replace.

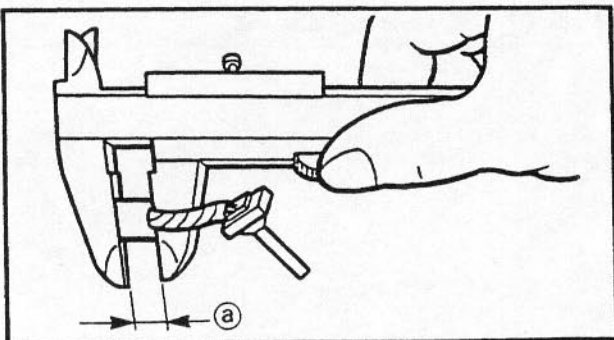

 **Brush length limit:**  
5.0 mm (0.20 in)





6. Measure:

- Brush spring force  
Fatigue/Out of specification → Replace as a set.



**Brush spring force:**  
680 ~ 920 g (24.0 ~ 32.4 oz)

7. Inspect:

- Bearing ①
- Oil seal ②
- Bush ③
- Damage → Replace the bracket.
- O-rings ④
- Wear/Damage → Replace.

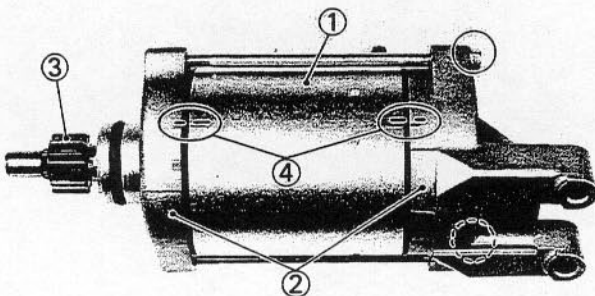
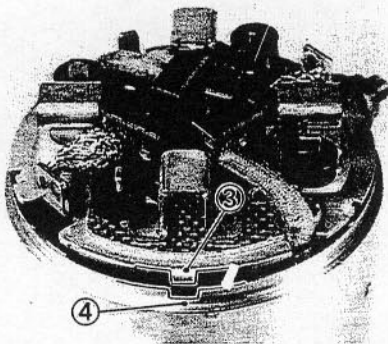
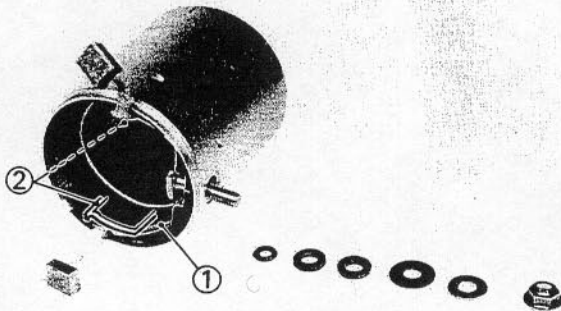
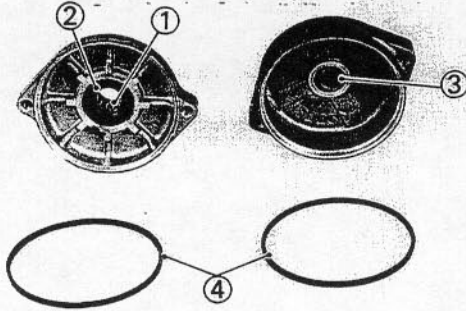

**Assembly**

Reserve the "Removal" procedure.  
Note the following points.

1. Install:

- Brush holder set

**NOTE:**

- Align the brush plate ① with the slot ② on the yoke as shown.
- Align the projection ③ on the brush seat with the slot ④ on the housing.

2. Install:

- Yoke ①
- Brackets ②
- Starting drive gear ③

**NOTE:**

Align the match marks ④ on the yoke with the match marks on the brackets.

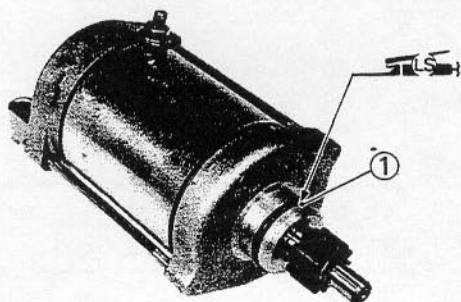

**Bolt:**  
5 Nm (0.5 m•kg, 3.6 ft•lb)

**Installation**

## 1. Install:

- Starter motor

**NOTE:**

Apply a lightly grease to the O-ring ①.

**Bolt (starter motor):****10 Nm (1.0 m•kg, 7.2 ft•lb)**

Refer to the "ENGINE OVERHAUL—ENGINE ASSEMBLY" section in the CHAPTER 4.

**CHARGING SYSTEM  
CIRCUIT DIAGRAM**

Below circuit diagram shows charging system.

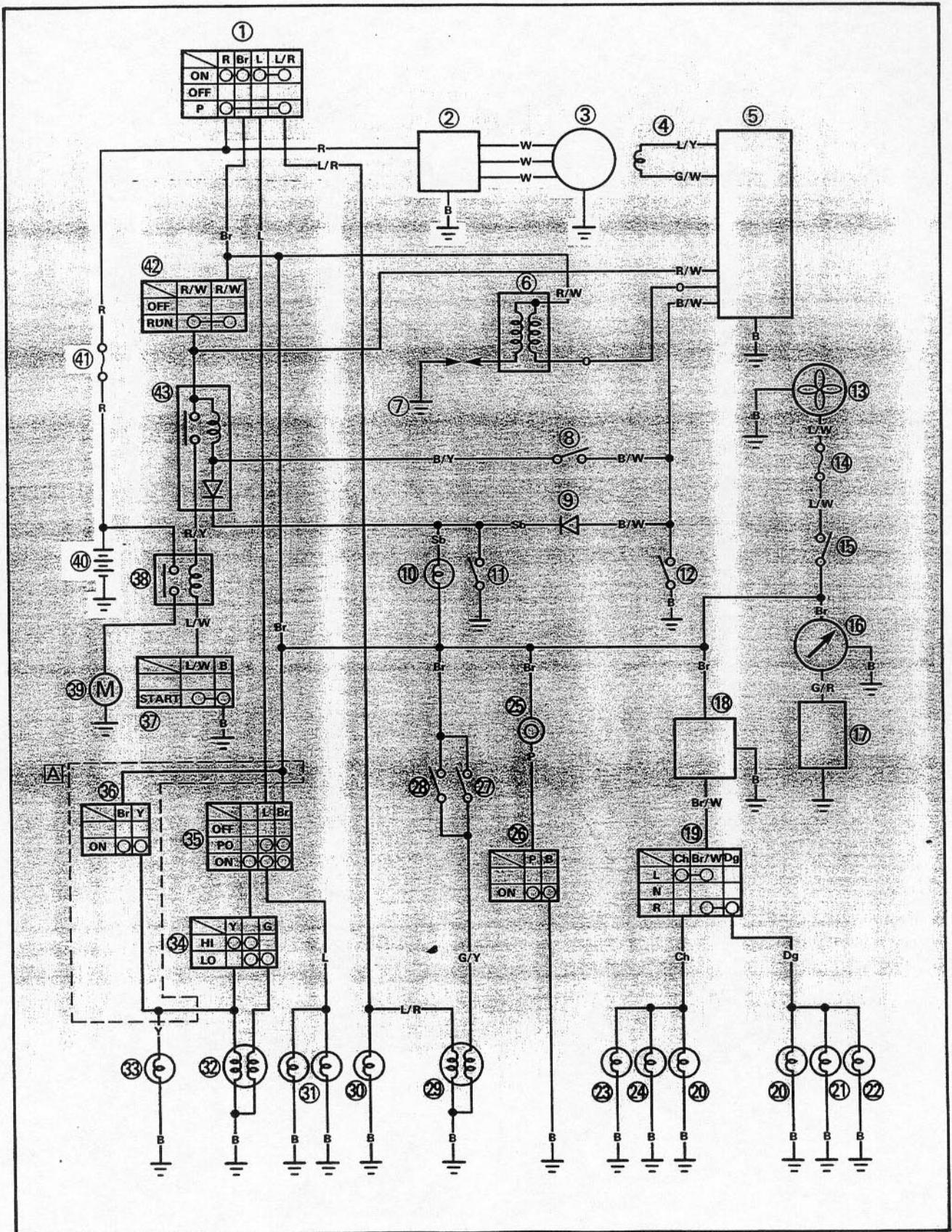



**NOTE:** \_\_\_\_\_  
For the color codes, see page 8-2.

- ② Rectifier/Regulator
- ③ A.C. magneto
- ④ Battery
- ④ Fuse (main)

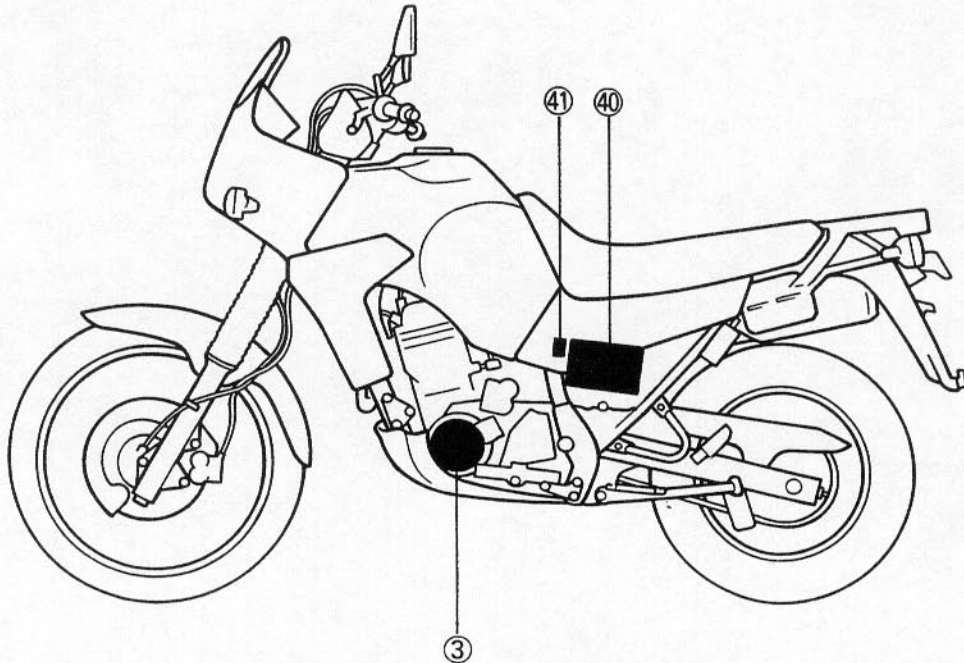
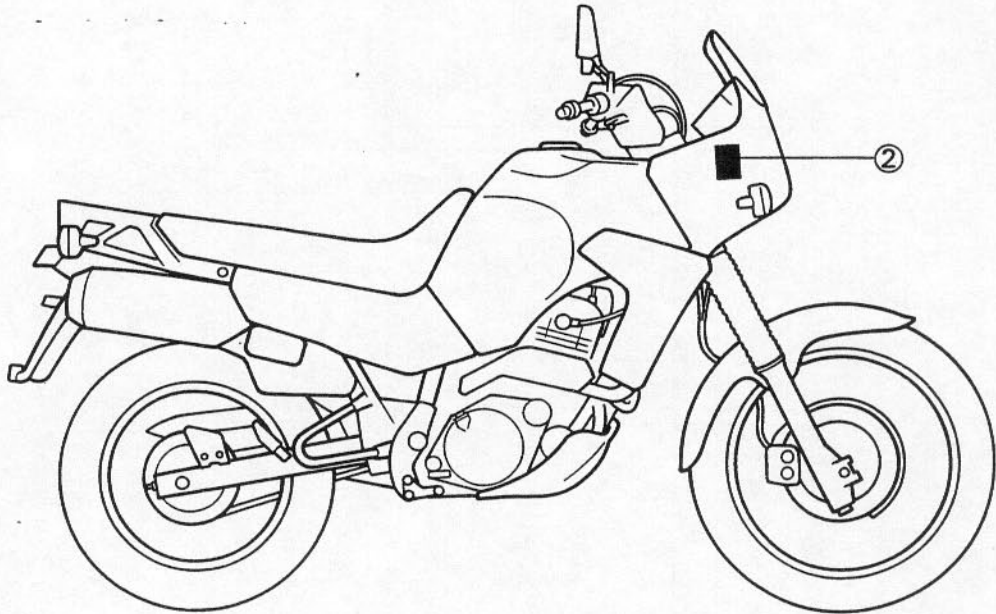



## TROUBLESHOOTING

### THE BATTERY IS NOT CHARGED.

#### Procedure

#### Check:

1. Fuse (main)
2. Battery
3. Charging voltage
4. Stator coil resistance
5. Wiring connection  
(Entire charging system)

#### NOTE:

- Remove the following parts before troubleshooting.
  - 1) Seat
  - 2) Side cover (left)
- Use the following special tool(s) in this troubleshooting.



**Inductive tachometer:**  
P/N YU-08036-A, 90890-03113



**Pocket tester:**  
P/N YU-03112, 90890-03112

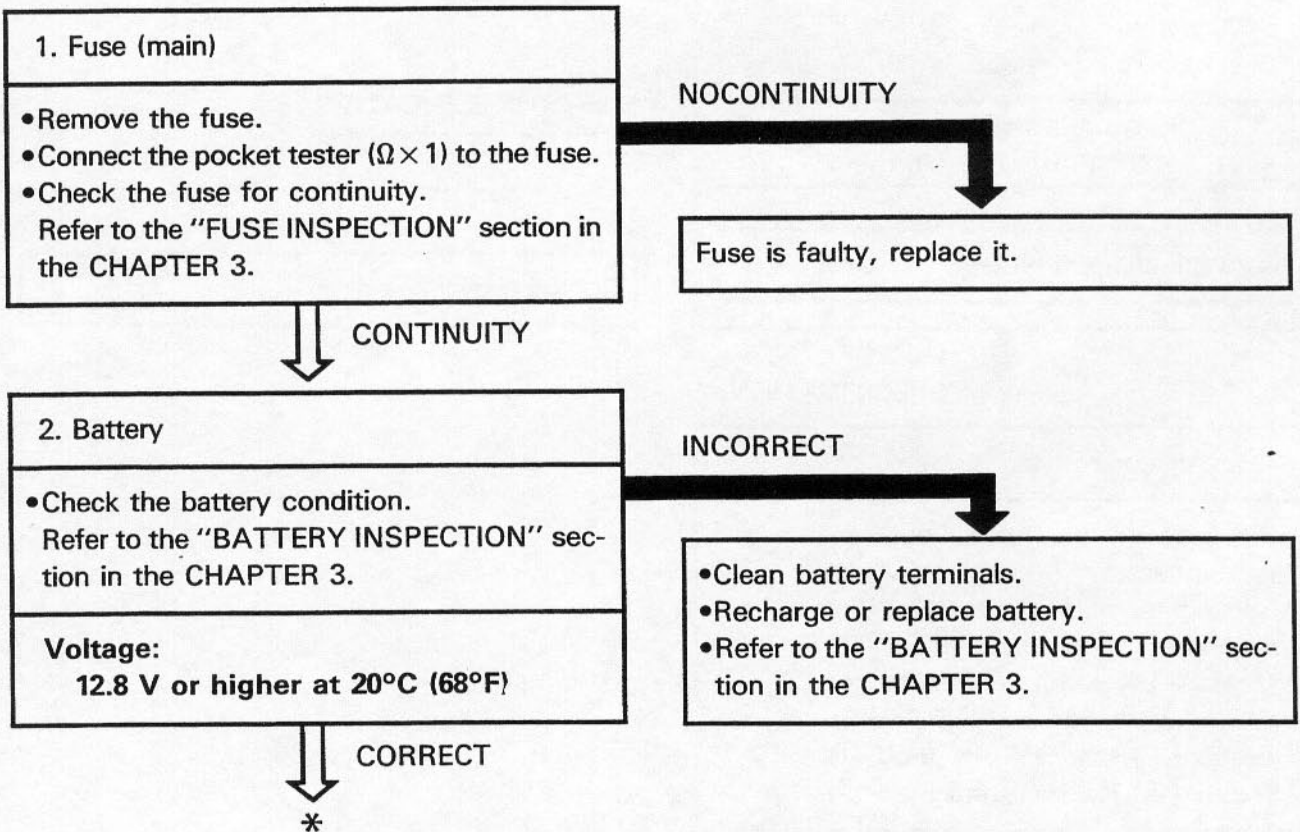



3. Charging voltage

- Connect the inductive tachometer to the spark plug lead.
- Connect the pocket tester (DC20V) to the battery.

Tester (+) lead → Battery (+) terminal  
 Tester (-) lead → Battery (-) terminal

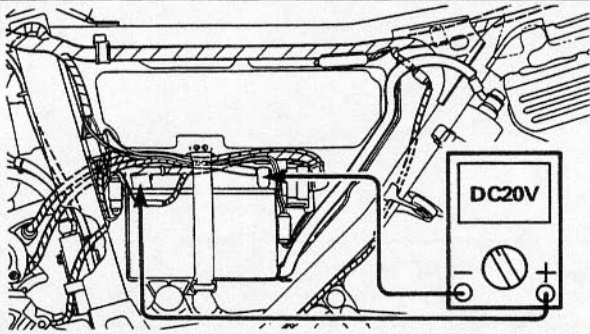

- Start the engine and accelerate to about, 5,000 r/min.
- Check charging voltage.



**Charging voltage:**  
 14.0 V at 5,000 r/min

**NOTE:** \_\_\_\_\_  
 Use a full charged battery.

MEETS SPECIFICATION

Charging circuit is good.

OUT OF SPECIFICATION

4. Stator coil resistance

- Disconnect the stator coil coupler from the wireharness.
- Connect the pocket tester " $\Omega \times 1$ " to the stator coils.
- Measure the stator coil resistances.

Tester (+) lead → White lead ①  
 Tester (-) lead → White lead ②

Tester (+) lead → White lead ①  
 Tester (-) lead → White lead ③



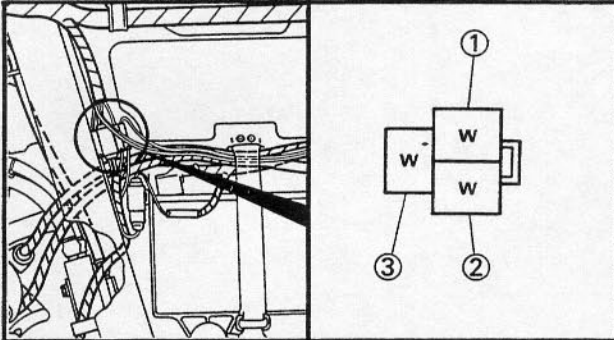

OUT OF SPECIFICATION

Stator coil is faulty, replace it.

 **Stator coil resistance:**  
**0.2 ~ 0.3Ω at 20°C (68°F)**

BOTH MEET SPECIFICATIONS

5. Wiring connection  
Check the entire ignition system for connections.  
Refer to the "WIRING DIAGRAM" section.

POOR CONNECTION

Correct.

OK

Replace rectifier/regulator.





**LIGHTING SYSTEM  
CIRCUIT DIAGRAM**

Below circuit diagram shows lighting system.

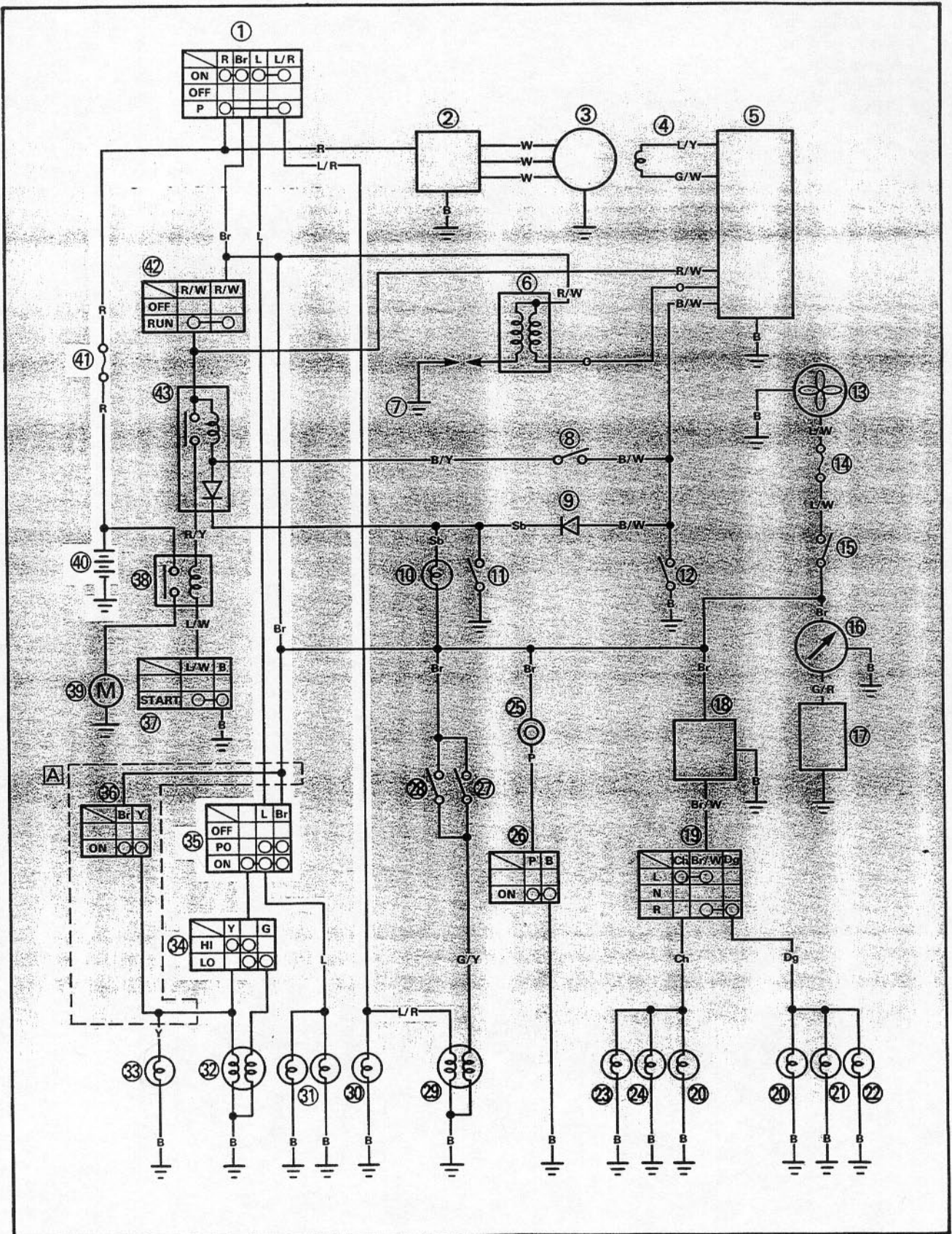



NOTE: \_\_\_\_\_  
For color codes, see page 8-2.  
\_\_\_\_\_

- ① Main switch
- ② Tail/Brake light
- ③ Auxiliary light
- ④ Meter light
- ⑤ Headlight
- ⑥ "HIGH BEAM" indicator light
- ⑦ "LIGHTS" (dimmer) switch
- ⑧ "LIGHTS" switch
- ⑨ Battery
- ⑩ Fuse (main)

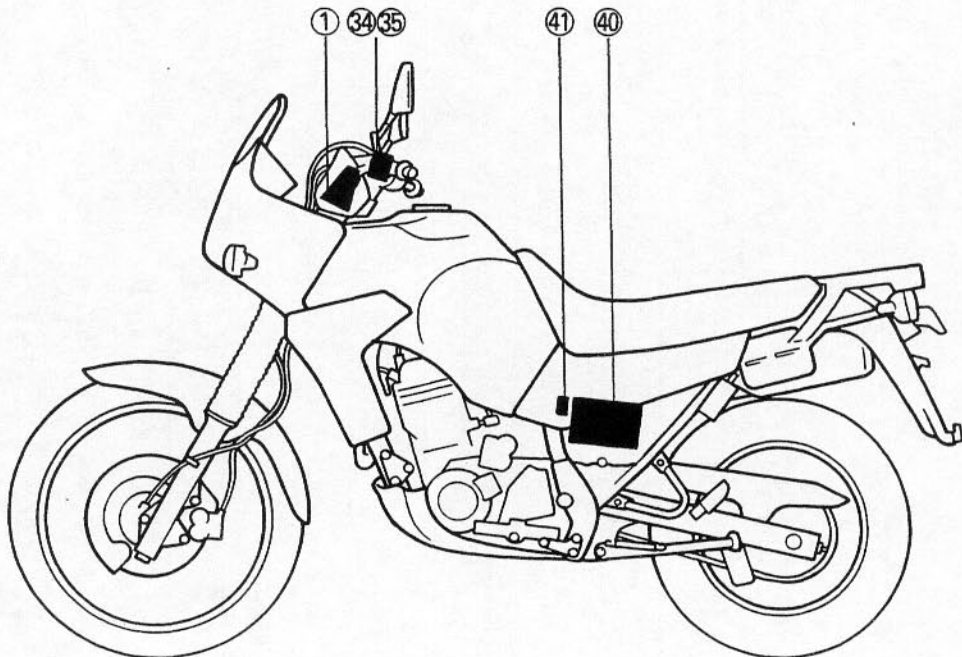
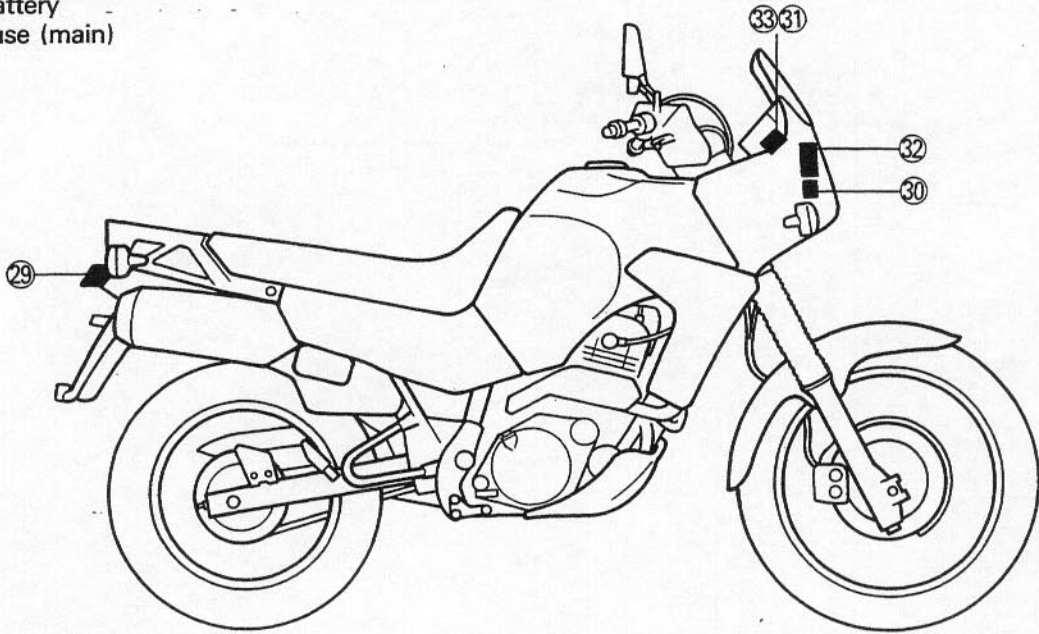



TROUBLESHOOTING

**HEADLIGHT, "HIGHBEAM" INDICATOR LIGHT, TAILLIGHT AND/OR METER LIGHT DO NOT COME ON**

**Procedure**

**Check:**

- |                |  |
|----------------|--|
| 1. Bulb        | 5. "LIGHTS" and "LIGHTS" (Dimmer) switch |
| 2. Fuse (main) | 6. Wiring connection                     |
| 3. Battery     | (Entire lighting system)                 |
| 4. Main switch |  |

**NOTE:**

- Remove the following parts before troubleshooting.
 

1) Seat	4) Fuel tank
2) Side covers	5) Inner panel
3) Air scoops	
- Use the following special tool(s) in this troubleshooting.

**Pocket tester:**  
P/N YU-03112, 90890-03112

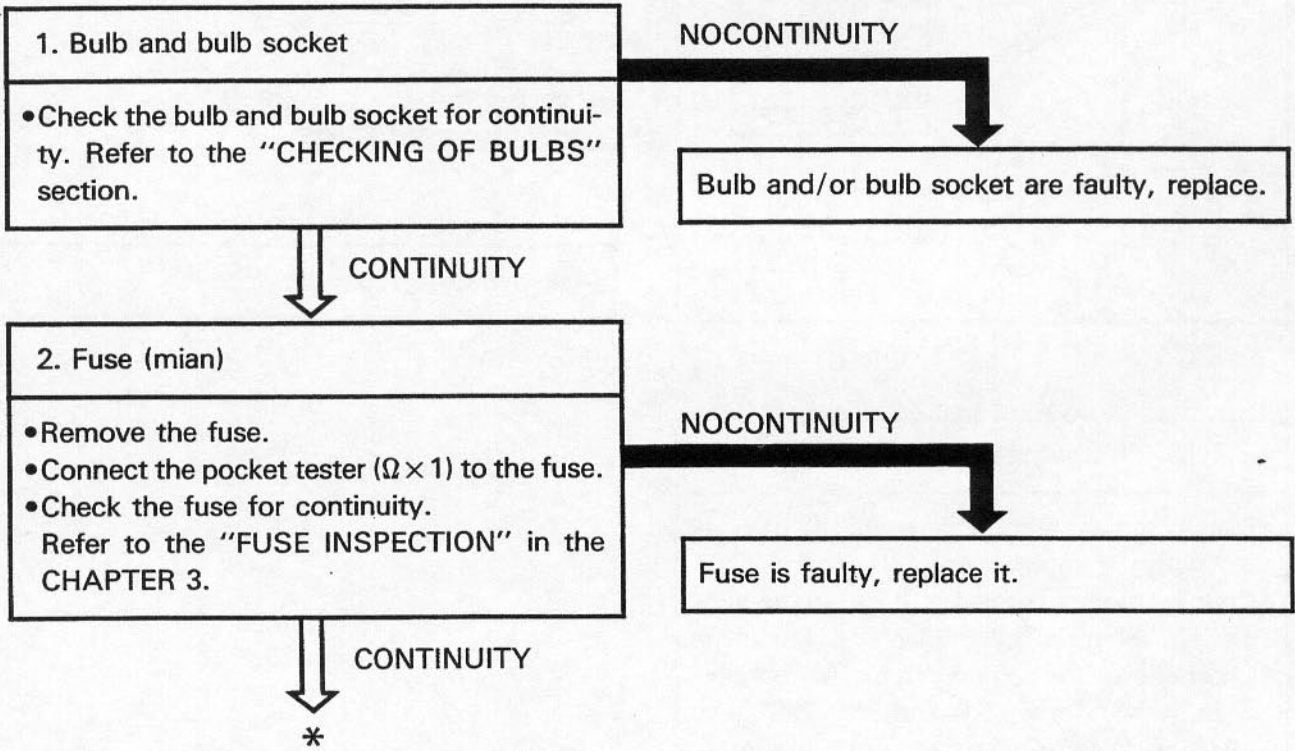



**3. Battery**

- Check the battery condition. Refer to the "BATTERY INSPECTION" section in the CHAPTER 3.

**Voltage:**  
12.8 V or higher at 20°C (68°F)

INCORRECT

- Clean battery terminals.
- Recharge or replace battery.
- Recharge or replace battery. Refer to the "BATTERY INSPECTION" section in the CHAPTER 3.

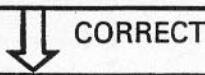

**4. Main switch**

- Disconnect the main switch coupler from the wireharness.
- Check the switch component for the continuity between "Red ① and Brown ②", "Blue ③ and Blue/Red ④". Refer to the "CHECKING OF SWITCHES" section.

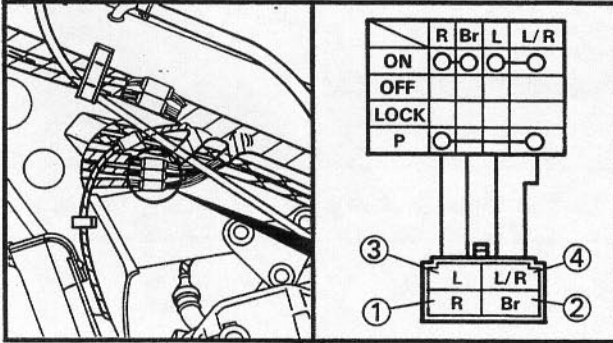

	R	Br	L	L/R
ON	○	○	○	○
OFF				
LOCK				
P	○			

INCORRECT

Main switch is faulty, replace it.

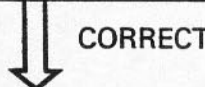

**5. "LIGHTS" and "LIGHTS" (dimmer) switch**

- Disconnect the handlebar switch (left) coupler from the wireharness.
- Connect the pocket tester ( $\Omega \times 1$ ) to the handlebar switch (left) terminal.
- Check the switch component for the continuity between "Brown ① and Blue ②". "Brown ① and Green ③" and "Brown ① and Yellow ④". Refer to the "CHECKING OF SWITCHES" section.



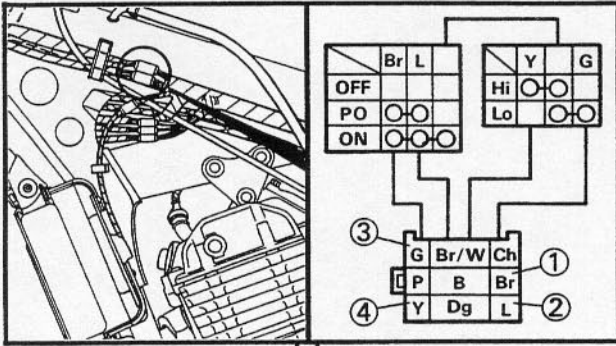

INCORRECT

"LIGHTS" and "LIGHTS" (dimmer) switch is faulty, replace handlebar switch (left).

CORRECT

**6. Wiring connection**

Check the entire lighting system for connections.  
Refer to the "WIRING DIAGRAM" section.

POOR CONNECTION

Correct.

CORRECT

This circuit is good.





**SIGNAL SYSTEM  
CIRCUIT DIAGRAM**

Below circuit diagram shows signal system.

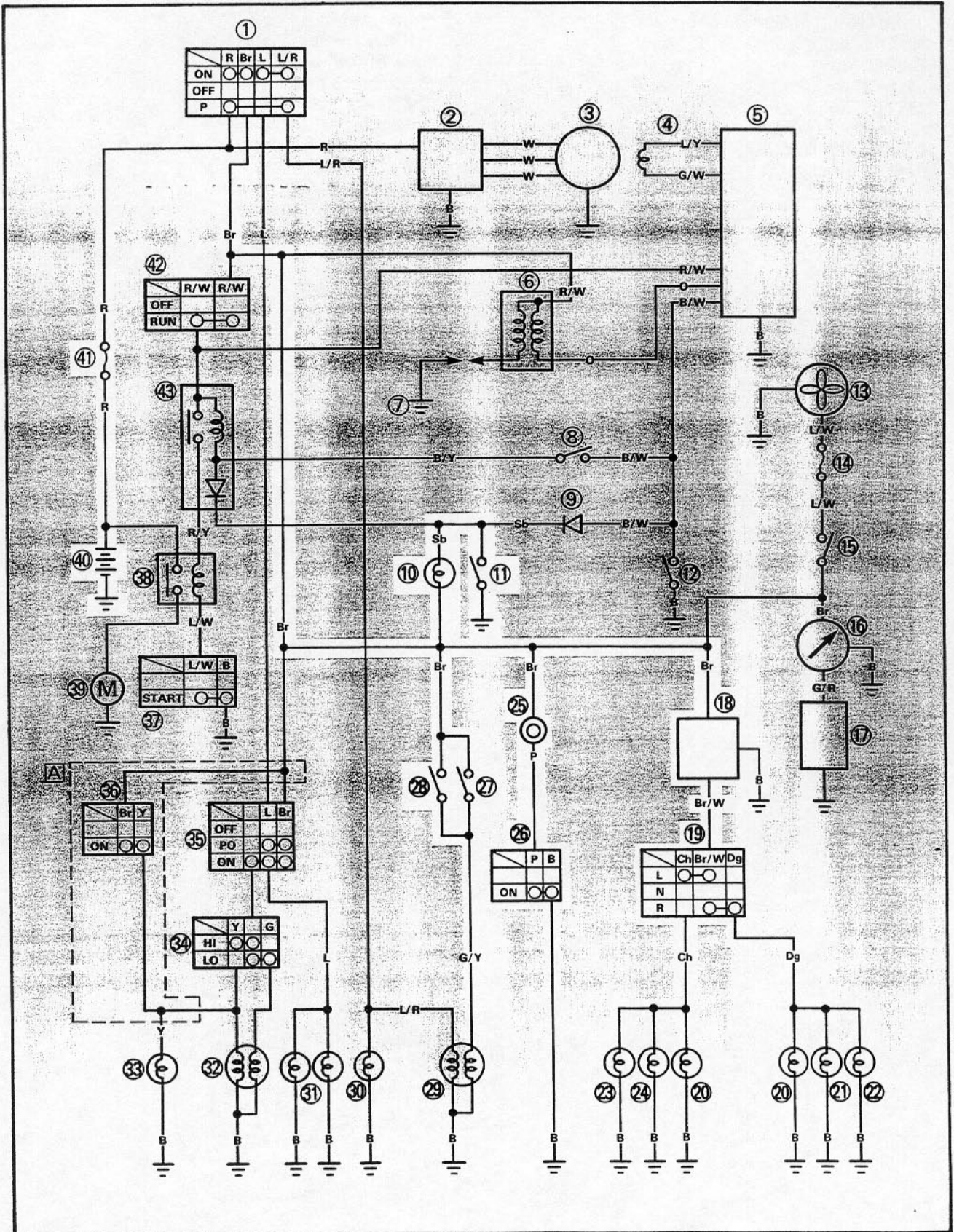





NOTE:

For the color codes, see page 8-2.

- ① Main switch
- ⑩ "NEUTRAL" indicator light
- ⑪ Neutral switch
- ⑱ Flasher relay
- ⑲ "TURN" switch
- ⑳ "TURN" indicator light
- ㉑ Front flasher light (R)
- ㉒ Rear flasher light (R)
- ㉓ Rear flasher light (L)
- ㉔ Front flasher light (L)
- ㉕ Horn
- ㉖ "HORN" switch
- ㉗ Rear brake switch
- ㉘ Front brake switch
- ㉙ Tail/brake light
- ㉚ Battery
- ㉛ Fuse (main)

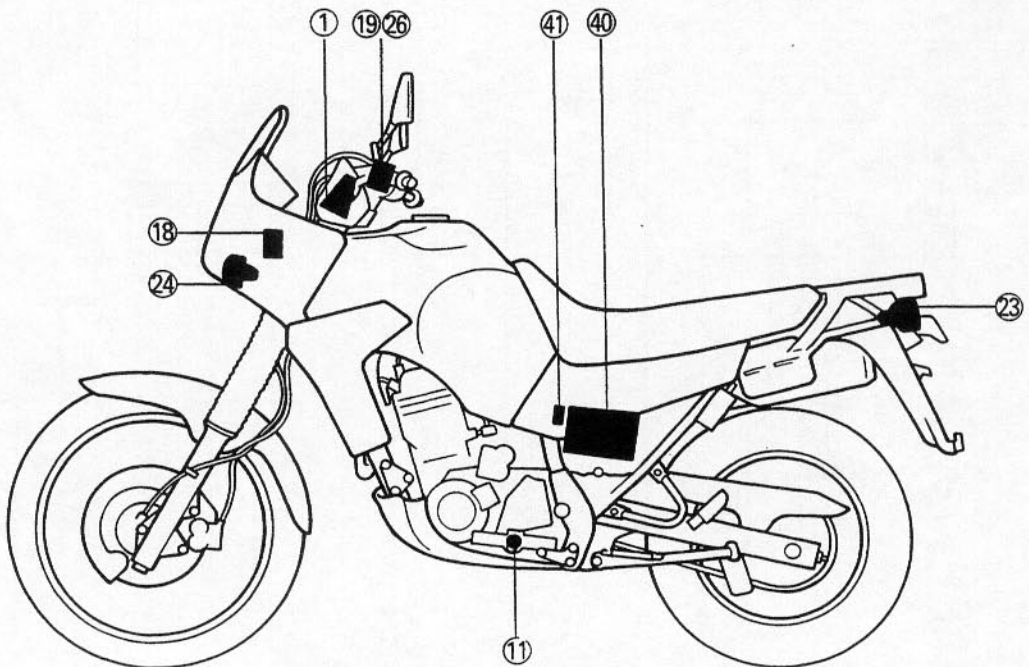
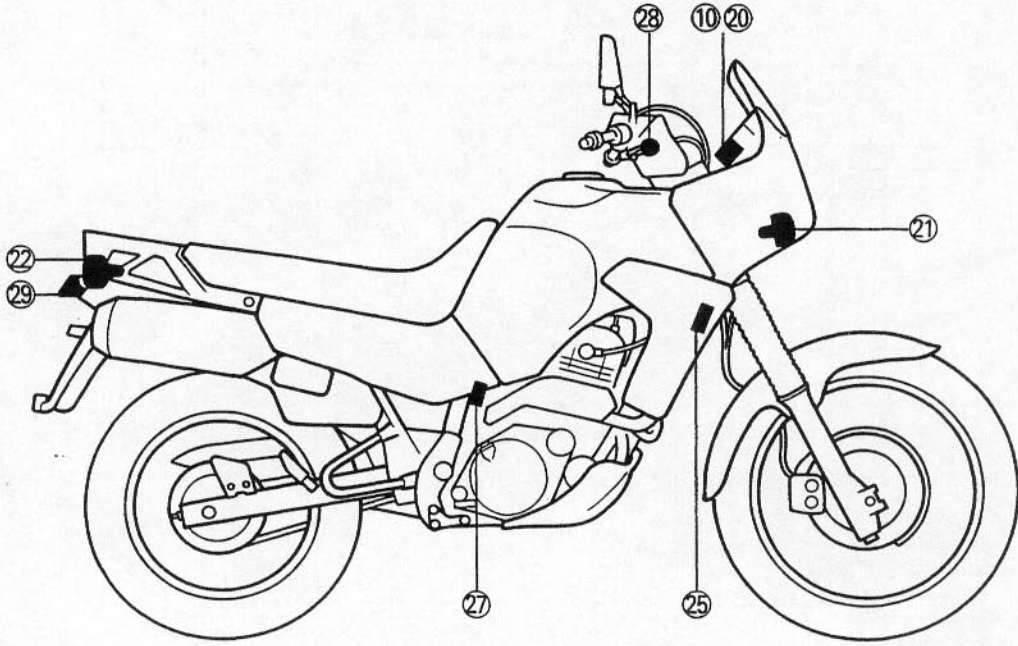



**TROUBLESHOOTING**

•FLASHER LIGHT, BRAKE LIGHT AND/OR INDICATOR LIGHT DO NOT COME ON.  
 •HORN DOES NOT SOUND.

**Procedure**

Check:

1. Fuse (main)
2. Battery
3. Main switch
4. Wiring connection  
(Entire signal system)

**NOTE:**

- Remove the following parts before troubleshooting.
 

1) Seat	4) Fuel tank
2) Side covers	5) Inner panel
3) Air scoops	6) Rear carrier
- Use the following special tool in this troubleshooting.

**Pocket tester:**  
 P/N YU-03112, 90890-03112

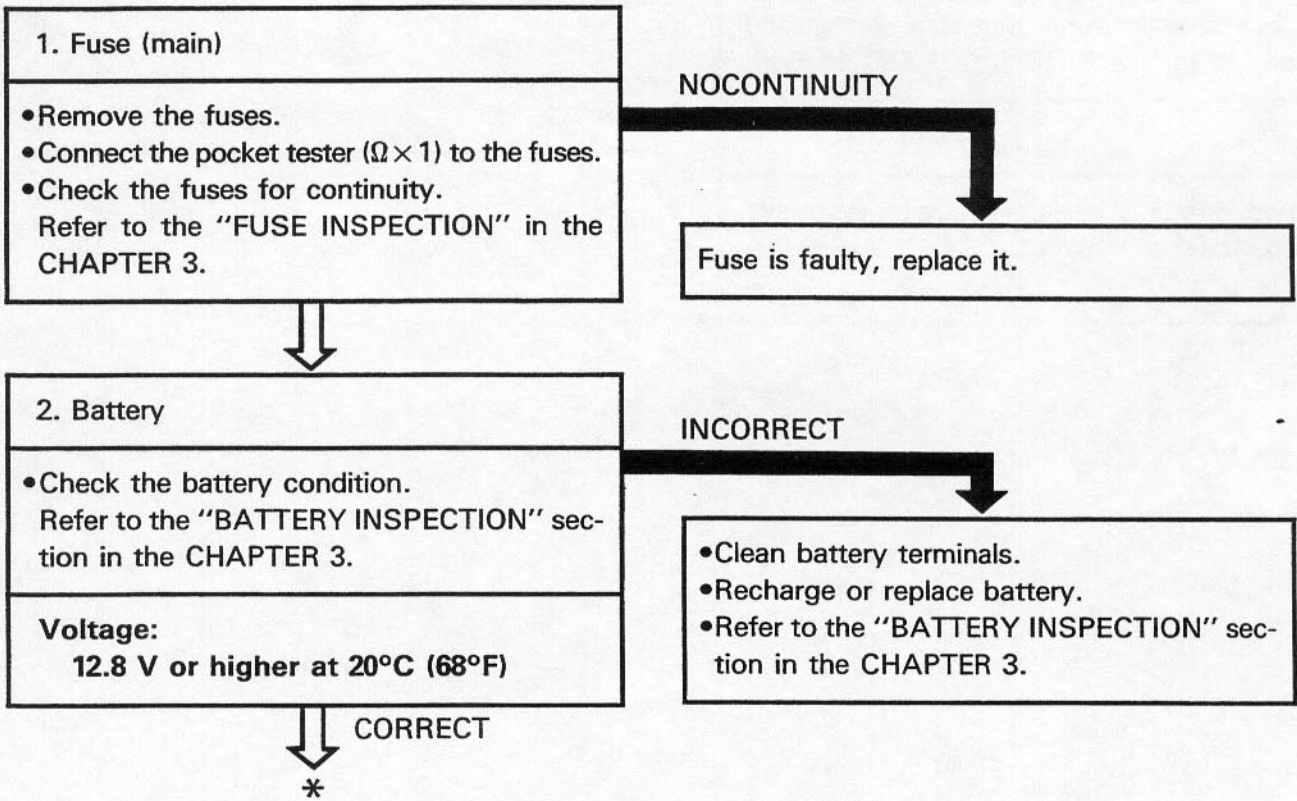



3. Main switch

- Disconnect the main switch coupler from the wireharness.
- Check the switch component for the continuity between "Red ① and Brown ②". Refer to the "CHECKING OF SWITCHES" section.

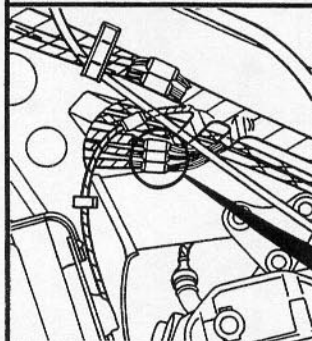

	R	Br	L	L/R
ON	○	○	○	○
OFF				
LOCK				
P	○			

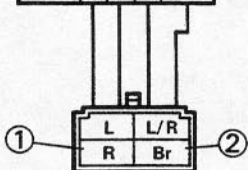

INCORRECT

Main switch is faulty, replace it.

CORRECT

4. Wiring connection

Check the entire signal system for connections. Refer to the "WIRING DIAGRAM" section.

POOR CONNECTION

Correct.

CORRECT

Check condition of each circuit for signal system. Refer to "SIGNAL SYSTEM CHECK" section.





**SIGNAL SYSTEM CHECK**

1. Horn does not sound.

1. "HORN" switch.

- Disconnect the handlebar switch (left) coupler from the wireharness.
- Check the switch component for the continuity between "Pink ① and Black ②". Refer to the "CHECKING OF SWITCHES" section.

	P	B
ON (Push)	○	○
OFF (Free)		

INCORRECT

"HORN" switch is faulty, replace handlebar switch (left).

CORRECT

2. Voltage

- Connect the pocket tester (DC20V) to the horn lead.

Tester (+) lead → Brown lead ①  
 Tester (-) lead → Frame ground

- Turn the main switch to "ON".
- Check for voltage (12V) on the "Brown" lead at the horn terminal.

OUT OF SPECIFICATION

Wiring circuit from main switch to horn terminal is faulty, repair.

MEETS SPECIFICATION (12V)

\*



**3. Horn**

- Disconnect the "Pink" lead from the horn terminal.
- Connect a jumper lead ① to the horn terminal and ground the jumper lead.
- Turn the main switch to "ON".

HORN IS SOUNDED

Horn is good.

HORN IS NOT SOUNDED

**4. Voltage**

- Connect the pocket tester (DC20V) to the horn at the "Pink" terminal.

**Terminal (+) lead → Pink lead ①**  
**Tester (-) lead → Frame ground**

- Turn the main switch to "ON".
- Check for voltage (12V) on the "Pink" lead at the horn terminal.

OUT OF SPECIFICATION

Horn is faulty, replace it.

MEETS SPECIFICATION (12V)

Adjust or replace horn.



2. Brake light does not come on.

**1. Bulb and bulb socket**

- Check the bulb and bulb socket for continuity. Refer to the "CHECKING OF BULBS" section.

NOCONTINUITY

Replace bulb and/or bulb socket.

CONTINUITY

**2. Brake switch**

- Disconnect the brake switch leads from the wireharness.
- Check the switch component for the continuity between "Green/Yellow ① and Brown ②". Refer to the "CHECKING OF SWITCHES" section.

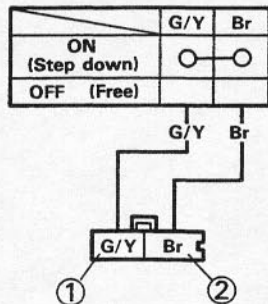
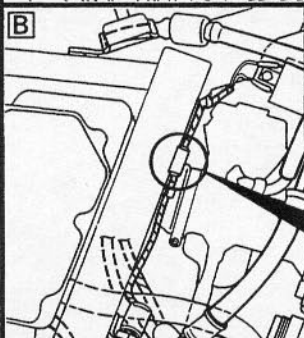
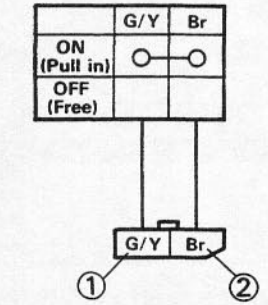
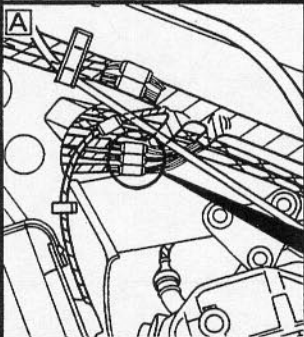

**A** Front brake switch  
**B** Rear brake switch

INCORRECT

Brake switch is faulty, replace it.

CORRECT

**3. Voltage**

- Connect the pocket tester (DC20V) to the bulb socket connector.

**Tester (+) lead → Green/Yellow ① lead**  
**Tester (-) lead → Black ② lead**



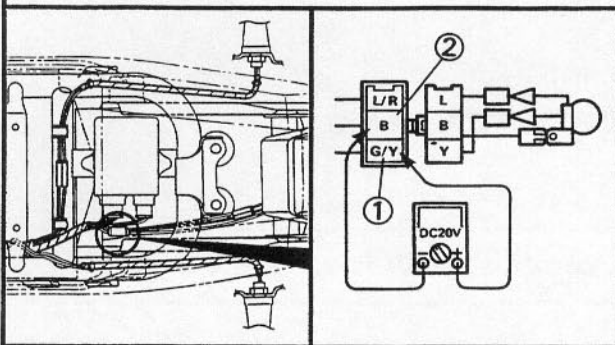

- Turn the main switch to "ON".
- The brake lever is pulled in or brake pedal is stepped down.
- Check for voltage (12V) on the "Green/Yellow" lead at the bulb socket connector.

OUT OF SPECIFICATION

Wiring circuit from main switch to bulb socket connector is faulty, repair.

MEETS SPECIFICATION (12V)

This circuit is good.

3. Flasher light and/or "TURN" indicator light do not blink.

NOCONTINUITY

1. Bulb and bulb socket
- Check the bulb and bulb socket for continuity. Refer to the "CHECKING OF BULBS" section.

Replace bulb and/or bulb socket.

CONTINUITY

2. "TURN" switch
- Disconnect the handlebar switch (left) coupler from the wireharness.
  - Check the switch component for the continuity between "Brown/White ① and Chocolate ②" and "Brown/White ① and Dark green ③". Refer to the "CHECKING OF SWITCHES" section.

INCORRECT

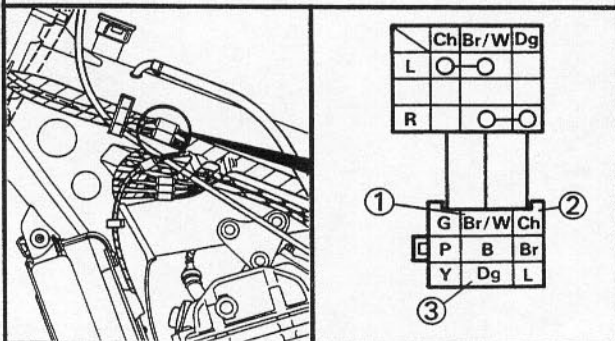

"TURN" switch is faulty, replace handlebar switch (left).

CORRECT

\*



**3. Voltage**

- Connect the pocket tester (DC20V) to the flasher relay.

**Tester (+) lead → Brown lead ①**  
**Tester (-) lead → Black lead ②**

- Turn the main switch to "ON".
- Check for voltage (12V) on the "Brown" lead at the flasher relay terminal.

OUT OF SPECIFICATION

Wiring circuit from main switch to flasher relay connector is faulty, repair.

MEETS SPECIFICATION (12V)

**4. Voltage**

- Connect the pocket tester (DC20V) to the flasher relay.

**Tester (+) lead → Brown/White lead ①**  
**Tester (-) lead → Black lead ②**

- Turn the main switch to "ON".
- Check for voltage (12V) on the "Brown/White" lead at the flasher relay terminal.

OUT OF SPECIFICATION

Flasher relay is faulty, replace it.

MEETS SPECIFICATION (12V)





**5. Voltage**

- Connect the pocket tester (DC20V) to the bulb socket connector.

**At flasher light (left):**  
 Tester (+) lead → Chocolate lead ①  
 Tester (-) lead → Frame ground

**At flasher light (right):**  
 Tester (+) lead → Dark green lead ②  
 Tester (-) lead → Frame ground

- Turn the main switch to "ON".
- Turn the "TURN" switch to "L" or "R".
- Check for voltage (12V) on the "Chocolate" lead or "Dark green" lead at the bulb socket connector.

OUT OF SPECIFICATION

Wiring circuit from "TURN" switch to bulb socket connector is faulty, repair.

MEETS SPECIFICATION (12V)

This circuit is good.

4. "NEUTRAL" indicator light does not come on.

**1. Bulb and bulb socket**

- Check the bulb and bulb socket for continuity. Refer to the "CHECKING OF BULBS" section.

NOCONTINUITY

Replace bulb and/or bulb socket.

CONTINUITY





2. Neutral switch

- Disconnect the neutral switch lead from the wireharness.
- Check the switch component for the continuity between "Sky blue ① and Ground". Refer to the "CHECKING OF SWITCHES" section.

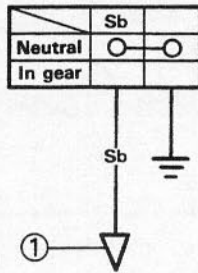
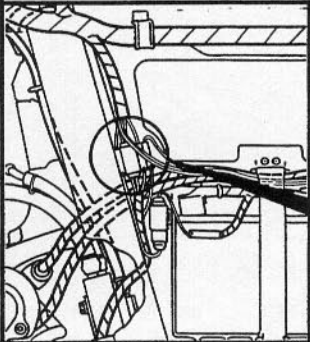

INCORRECT

Neutral switch is faulty, replace it.

CORRECT

3. Voltage

- Connect the pocket tester (DC20V) to the bulb socket connector.

Tester (+) lead → Brown lead ①  
 Tester (-) lead → Black lead ②

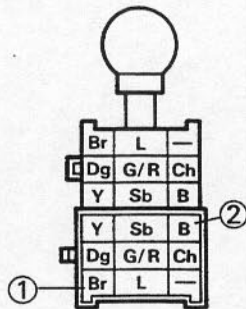
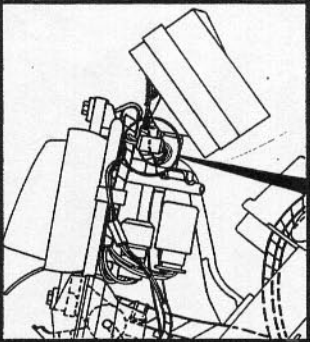

OUT OF SPECIFICATION

Wiring circuit from main switch to bulb socket connector is faulty, repair.

MEETS SPECIFICATION (12V)



4. Neutral switch lead.

- Disconnect the neutral switch lead and bulb socket connector from the wireharness.
- Connect the pocket tester ( $\Omega \times 1$ ) to the "Sky blue" neutral switch lead ① (wireharness side) and bulb socket terminal ②.

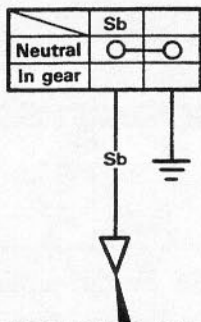
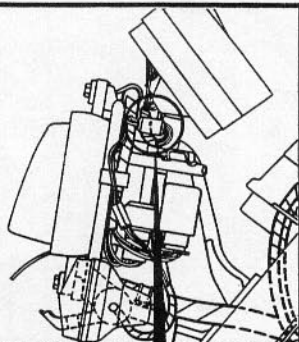

NOCONTINUITY

Wiring circuit from bulb socket to neutral switch lead is faulty, repair.

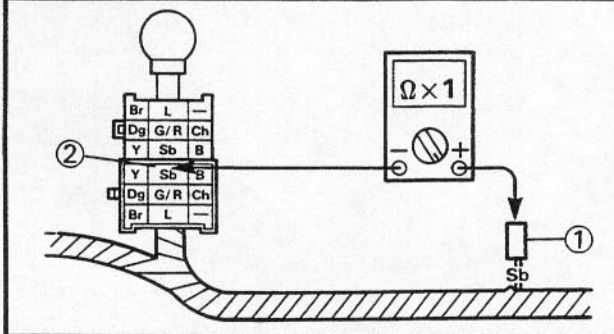

CONTINUITY

This circuit is good.



**COOLING SYSTEM**

**CIRCUIT DIAGRAM**

Below circuit diagram shows cooling system.

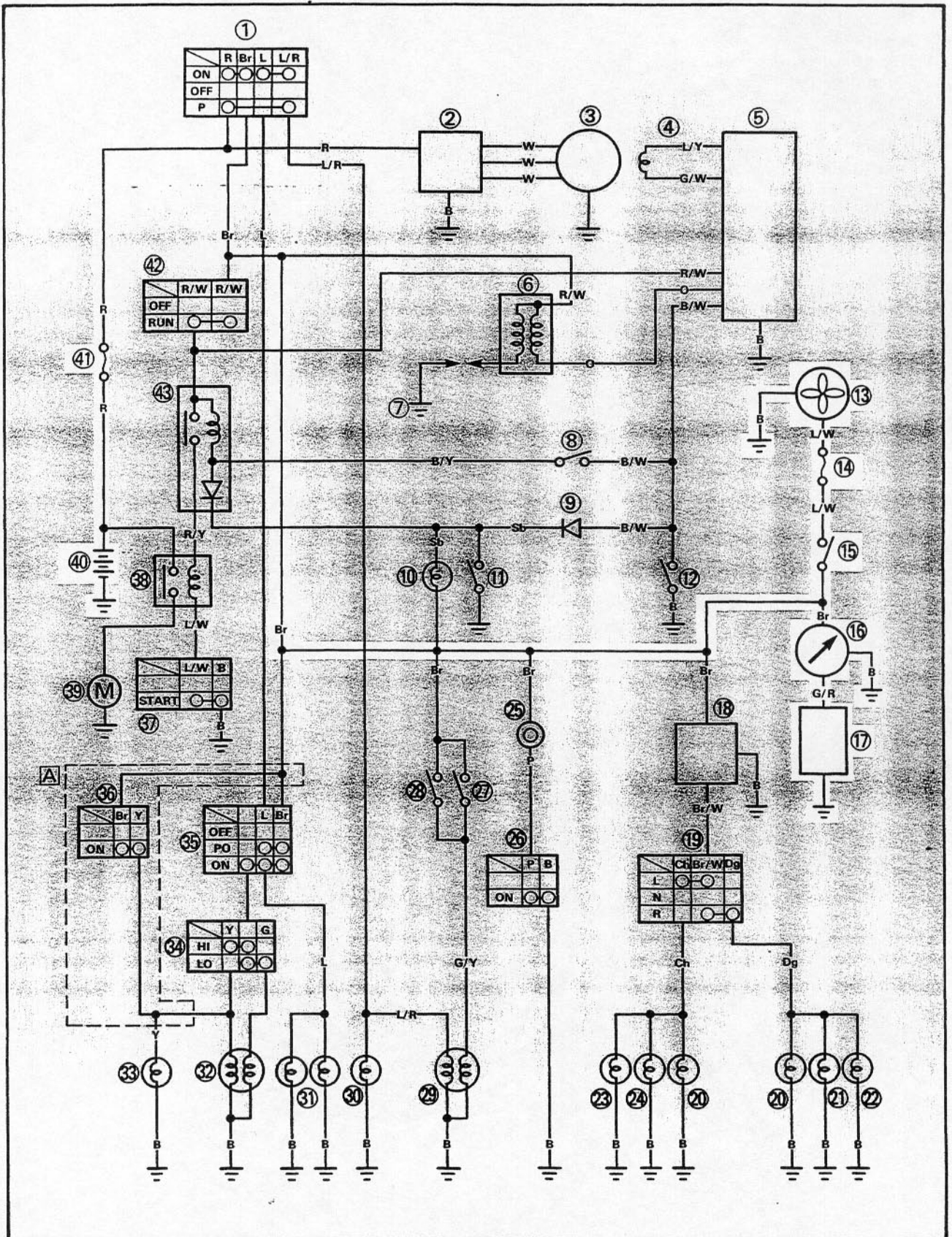



NOTE: \_\_\_\_\_

For the color codes, see page 8-2.

- ① Main switch
- ⑬ Fan motor
- ⑭ Fuse (fan motor)
- ⑮ Thermo switch
- ⑯ Temperature gauge
- ⑰ Thermo unit
- ④① Battery
- ④① Fuse (main)

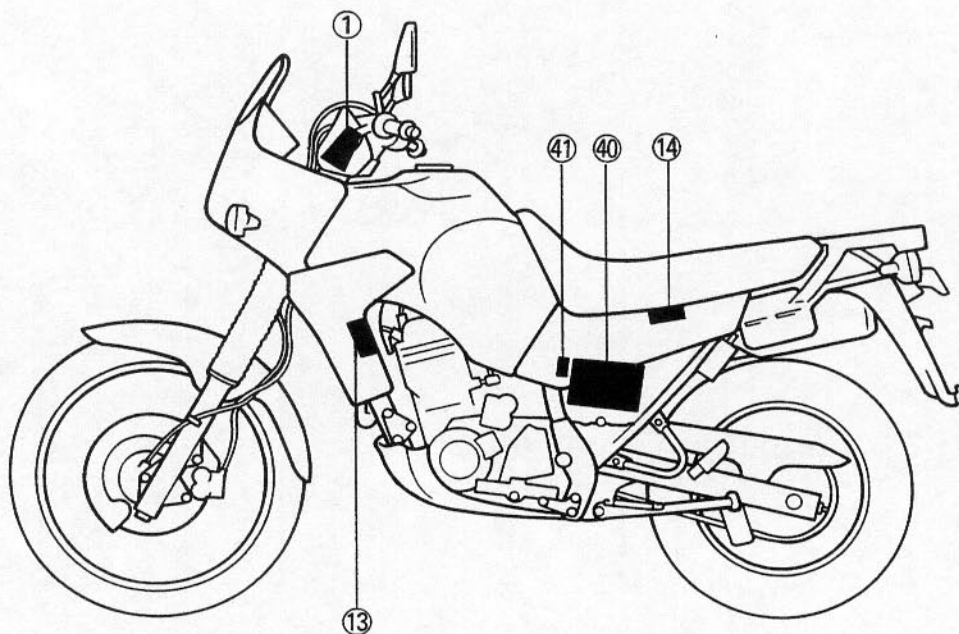
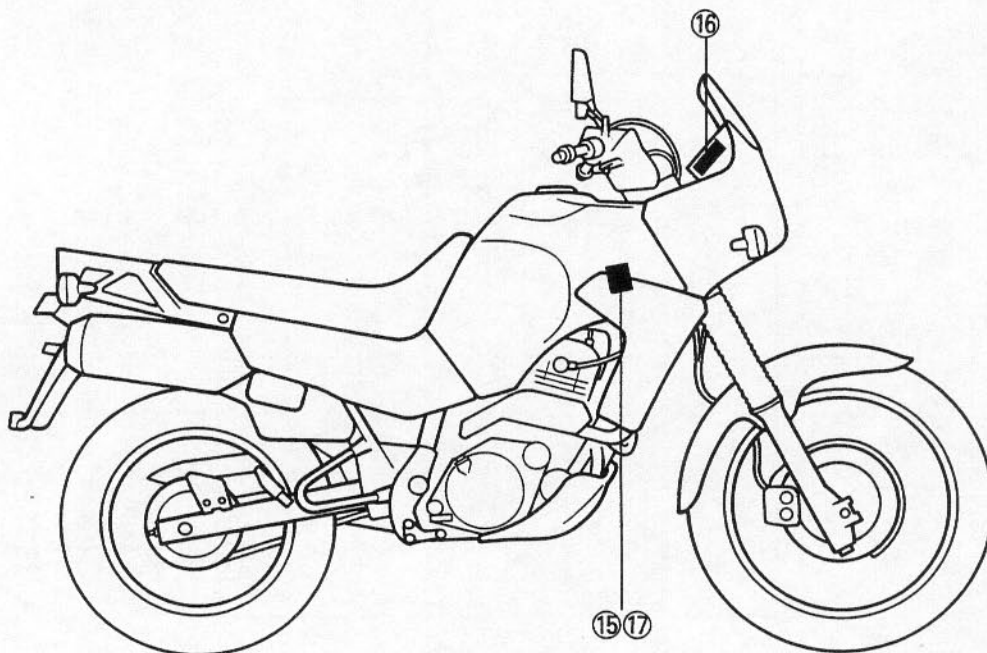



TROUBLESHOOTING

FAN MOTOR DOES NOT MOVE.

Procedure

Check:

- |                        |                         |
|------------------------|-------------------------|
| 1. Fuse (main and fan) | 6. Thermo switch        |
| 2. Battery             | 7. Wiring connection    |
| 3. Main switch         | (Entire cooling system) |
| 4. Fan motor (Test 1)  |                         |
| 5. Fan motor (Test 2)  |                         |

NOTE:

- Remove the following parts before troubleshooting.
 

1) Seat	4) Fuel tank
2) Side covers	5) Inner panel
3) Air scoops	
- Use the following special tool in this troubleshooting.

**Pocket tester:**  
P/N YU-03112, 90890-03112

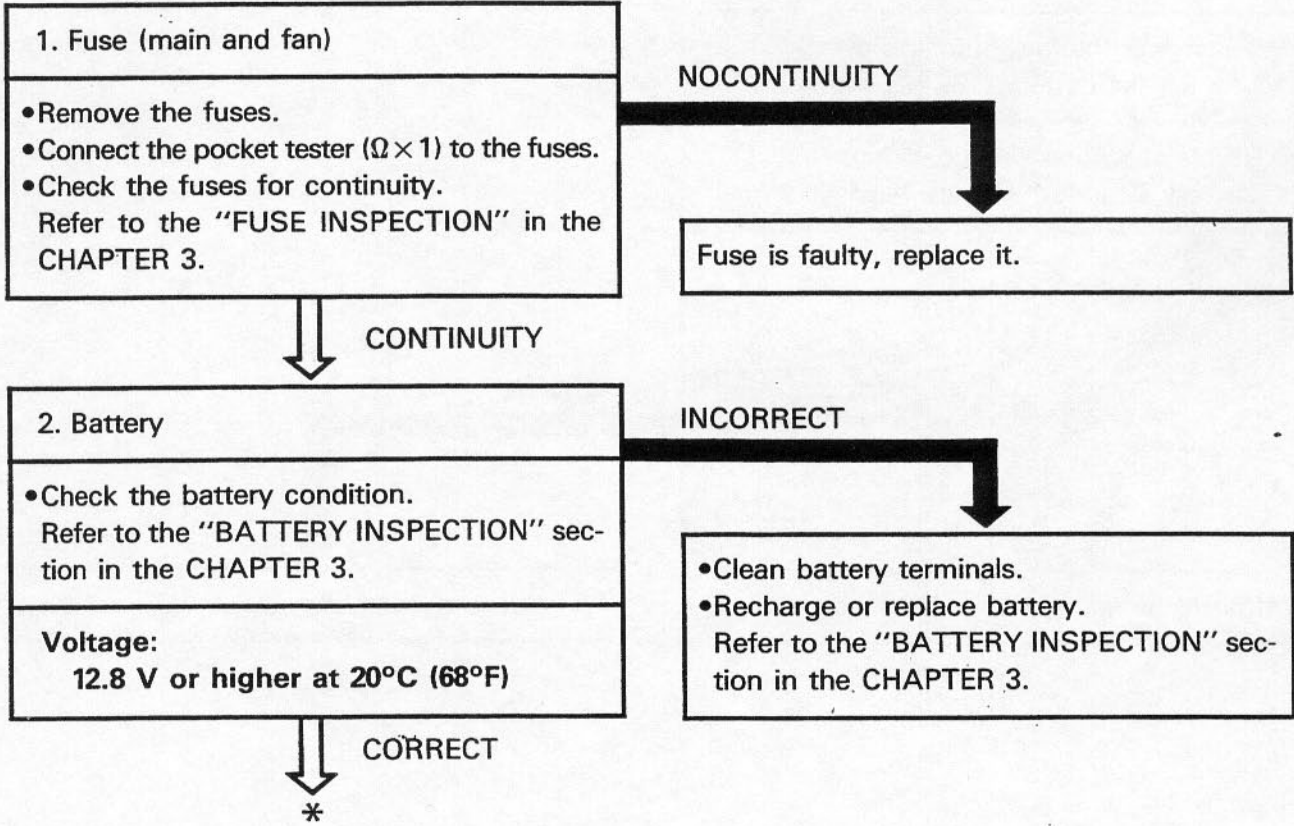



3. Main switch

- Disconnect the main switch coupler from the wireharness.
- Check the switch component for the continuity between "Red ① and Brown ②". Refer to the "CHECKING OF SWITCHES" section.

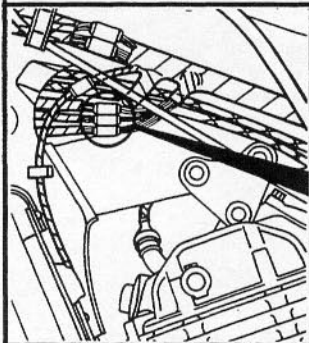

	R	Br	L	L/R
ON	○	○	○	○
OFF				
LOCK				
P	○			○

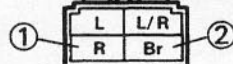

INCORRECT

Main switch is faulty, replace it.

CORRECT

4. Fan motor (test 1)

- Disconnect the fan motor coupler.
- Connect the battery (12V) as shown.

Battery (+) lead → Blue/White lead ①  
 Battery (-) lead → Black lead ②

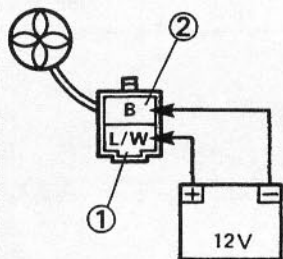
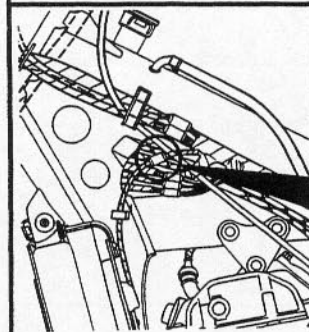

DOES NOT MOVES

Fan motor is faulty, replace it.

- Check the fan motor for operation.

MOVES







5. Fan motor (test 2)

- Disconnect the thermo switch leads coupler ("Blue/White" and "Brown").
- Turn the main switch to "ON".
- Connect the leads with a jumper lead ① as shown.

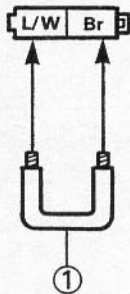
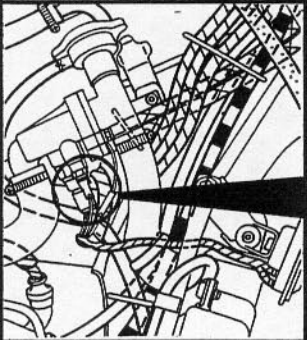

DOES NOT MOVE

Wiring circuit from main switch to fan motor leads is faulty, repair.

MOVES

6. Thermo switch

- Remove the thermo switch from the thermostat housing.
- Connect the pocket tester ( $\Omega \times 1$ ) to the thermo switch ①.
- Immerse the thermo switch in the coolant ②.
- Check the thermo switch for continuity. Note temperatures while heating the coolant with the temperature gauge ③.

Test step	Coolant temperature	Good condition
1	Less than $105 \pm 3^{\circ}\text{C}$ ( $221.0 \pm 5.4^{\circ}\text{F}$ )	×
2	More than $105 \pm 3^{\circ}\text{C}$ ( $221.0 \pm 5.4^{\circ}\text{F}$ )	○
3*	105 to $98^{\circ}\text{C}$ ( $221.0$ to $208.4^{\circ}\text{F}$ )	○
4*	Less than $98^{\circ}\text{C}$ ( $208.4^{\circ}\text{F}$ )	×

Test 1 and 2; Heat-up tests  
 Test 3\* and 4\*; Cool-down tests  
 ○ : Continuity × : Nocontinuity

**⚠ WARNING**

Handle the thermo switch with special care. Never subject to strong shock or allow it to be dropped. Should it be dropped, it must be replaced.



Thermo switch:  
 28 Nm (2.8 m•kg, 20 ft•lb)  
 Water resistant sealant

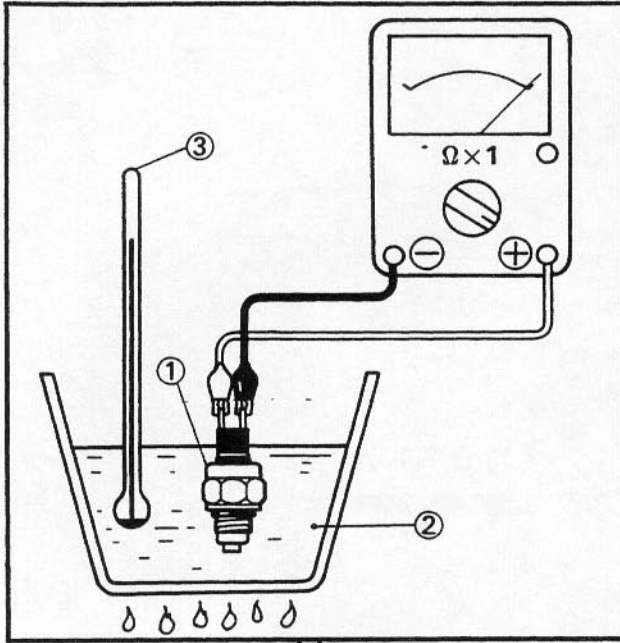

BAD CONDITION

Thermo switch is faulty, replace it.

GOOD CONDITION

7. Wiring connection

Check the entire cooling system for connections. Refer to the "WIRING DIAGRAM" section.

POOR CONNECTION

Correct.

CORRECT

This circuit is good.



**WHEN ENGINE IS HOT, TEMPERATURE GAUGE DOES NOT MOVE.**

### Procedure

Check:

- |                |                         |
|----------------|-------------------------|
| 1. Fuse (main) | 5. Voltage              |
| 2. Battery     | 6. Wiring connection    |
| 3. Main switch | (Entire cooling system) |
| 4. Thermo unit |                         |

### NOTE:

- Remove the following parts before troubleshooting.
 

1) Seat	4) Fuel tank
2) Side covers	5) Inner panel
3) Air scoops	
- Use the following special tool(s) in this troubleshooting.



**Pocket tester:**

**P/N YU-03112, 90890-03112**

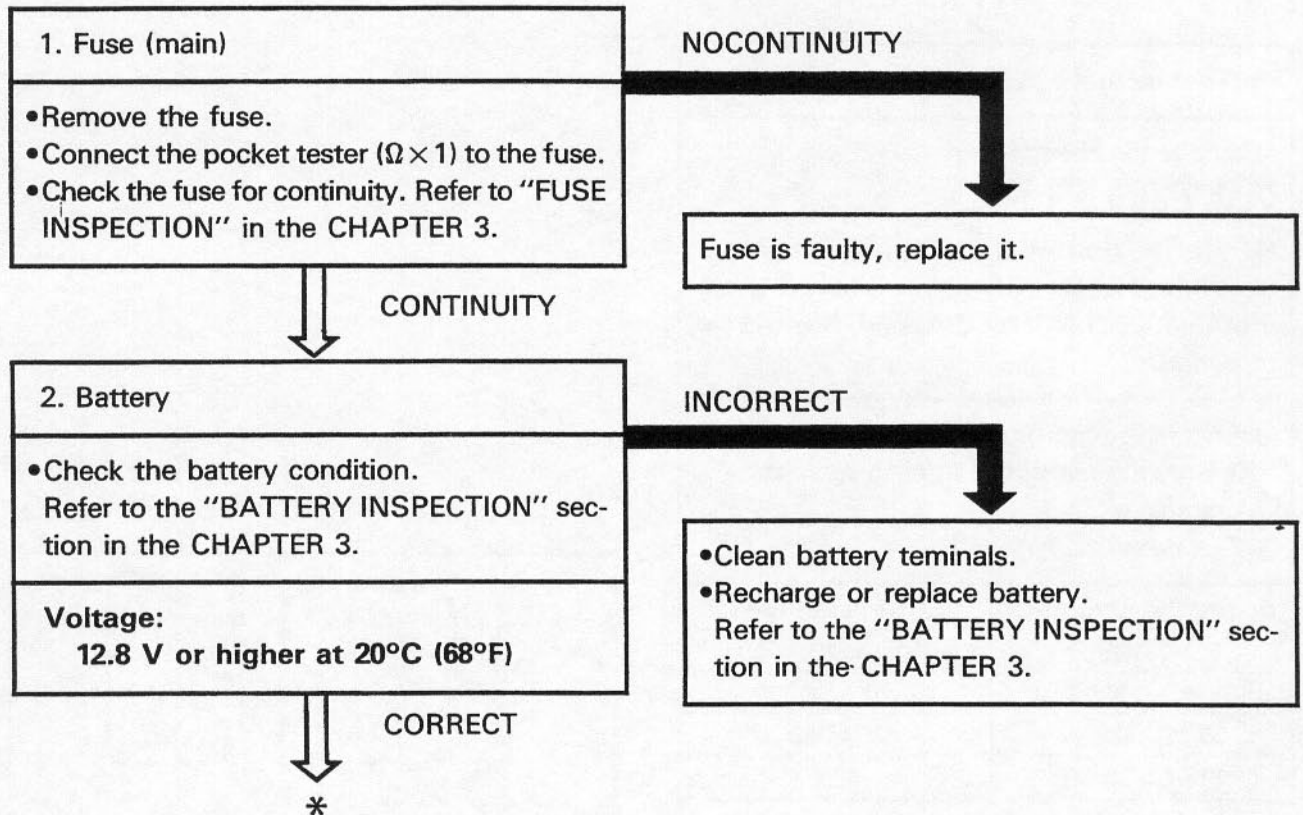





3. Main switch

- Disconnect the main switch coupler from the wireharness.
- Check the switch component for the continuity between "Red ① and Brown ②". Refer to the "CHECKING OF SWITCHES" section.

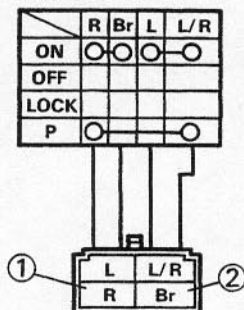
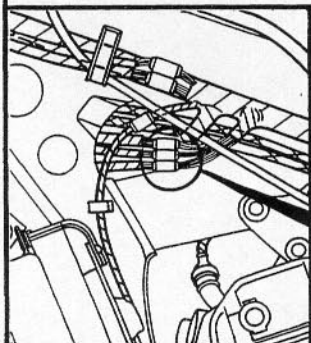

INCORRECT

Replace main switch.

CORRECT

4. Thermo unit

- Remove the thermo unit.

**WARNING**

Handle the thermo unit with special care. Never subject it to strong or allow it to be dropped. Should it be dropped, it must be replaced.

- Immerse the thermo unit ① in coolant ②.
  - Measure the resistance at each temperature as tabulated.
- ③ Thermometer

Coolant temperature	Resistance
50°C (122°F)	154Ω
80°C (176°F)	47 ~ 53Ω
100°C (212°F)	26 ~ 29Ω
120°C (248°F)	16Ω

- After measuring the thermo unit, install the unit.

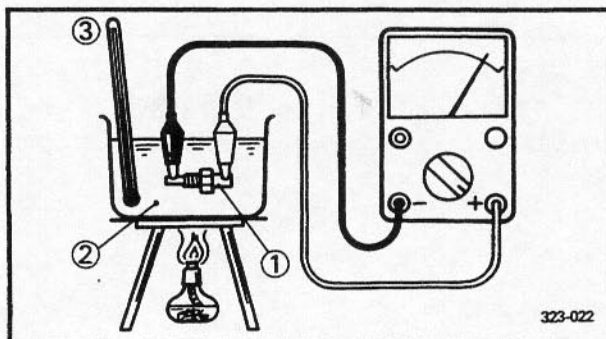

323-022

 Thermo unit:  
**15 Nm (1.5 m•kg, 11 ft•lb)**  
**Water resistant sealant**

---

**CAUTION:** \_\_\_\_\_  
**Avoid overtightening.**

---

OUT OF SPECIFICATION

Thermo unit is faulty, replace it.

MEET SPECIFICATIONS

**5. Voltage**

- Connect the pocket tester (DC20V) to the temperature gauge leads.

**Tester (+) lead → Brown lead ①**  
**Tester (-) lead → Black lead ②**

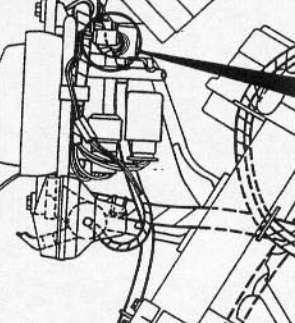

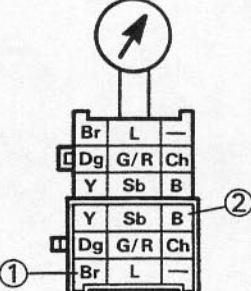

- Turn the main switch to "ON".
- Check for voltage (12V) on the "Brown" lead at the temperature gauge connector.

OUT OF SPECIFICATION

Wiring circuit from main switch to temperature gauge connector, repair.

MEETS SPECIFICATION (12V)

**6. Wiring connection**

Check the entire cooling system for connections. Refer to the "WIRING DIAGRAM" section.

POOR CONNECTION

Correct.

CORRECT

Replace tempmeter gauge.

---

## CHAPTER 9. TROUBLESHOOTING

STARTING FAILURE/HARD STARTING .....	B-4
POOR IDLE SPEED PERFORMANCE .....	B-5
POOR MEDIUM AND HIGH SPEED PERFORMANCE.....	B-5
FAULTY GEAR SHIFTING .....	B-5
CLUTCH SLIPPING/Dragging.....	B-5
OVERHEATING OR OVER-COOLING .....	B-6
FAULTY BRAKE .....	B-6
FRONT FORK OIL LEAKAGE AND FRONT FORK MALFUNCTION ...	B-6
INSTABLE HANDLING .....	B-7
FAULTY SIGNAL AND LIGHTING SYSTEMS .....	B-7
XTZ660 ['91] WIRING DIAGRAM	



**TROUBLESHOOTING**

**NOTE:**

The following troubleshooting does not cover all the possible causes of trouble. It should be helpful, however, as a guide to troubleshooting. Refer to the relative procedure in this manual for inspection, adjustment and replacement of parts.

**STARTING FAILURE/HARD STARTING**

**FUEL SYSTEM**

**PROBABLE CAUSE**

Fuel tank	<ul style="list-style-type: none"> <li>• Empty</li> <li>• Clogged fuel filter</li> <li>• Clogged fuel strainer</li> <li>• Clogged fuel breather hose</li> <li>• Deteriorated fuel or fuel containing water or foreign material</li> </ul>
Fuel cock	<ul style="list-style-type: none"> <li>• Clogged fuel hose</li> <li>• Clogged fuel filter</li> </ul>
Carburetor	<ul style="list-style-type: none"> <li>• Deteriorated fuel, fuel containing water or foreign material</li> <li>• Clogged pilot jet</li> <li>• Clogged pilot air passage</li> <li>• Sucked-in air</li> <li>• Deformed float</li> <li>• Groove-worn needle valve</li> <li>• Improperly sealed valve seat</li> <li>• Improperly adjusted fuel level</li> <li>• Improperly set pilot jet</li> <li>• Clogged starter jet</li> <li>• Starter plunger malfunction</li> <li>• Improperly adjusted starter cable</li> </ul>
Air filter element	<ul style="list-style-type: none"> <li>• Clogged</li> </ul>
Fuel pump	<ul style="list-style-type: none"> <li>• Faulty fuel pump</li> <li>• Clogged vacuum hose</li> </ul>

**ELECTRICAL SYSTEM**

**PROBABLE CAUSE**

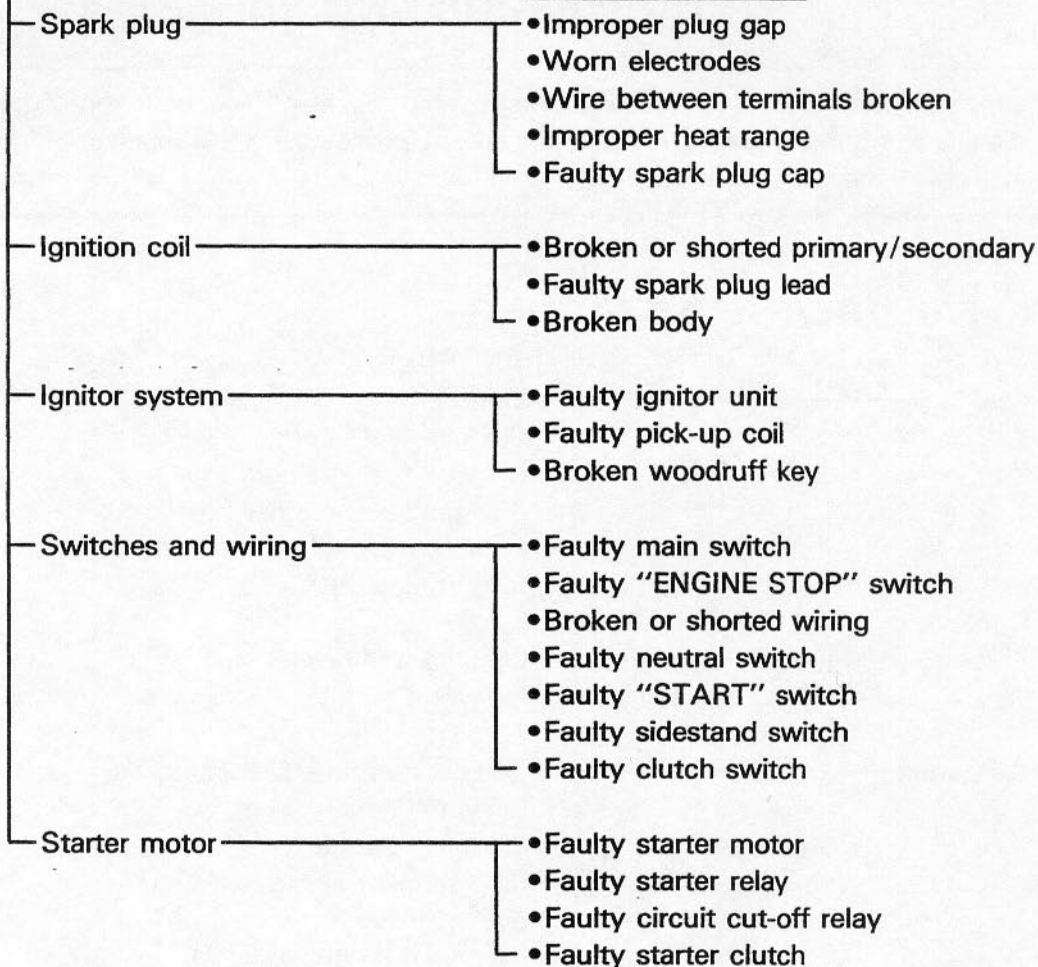

**COMPRESSION SYSTEM**

**PROBABLE CAUSE**

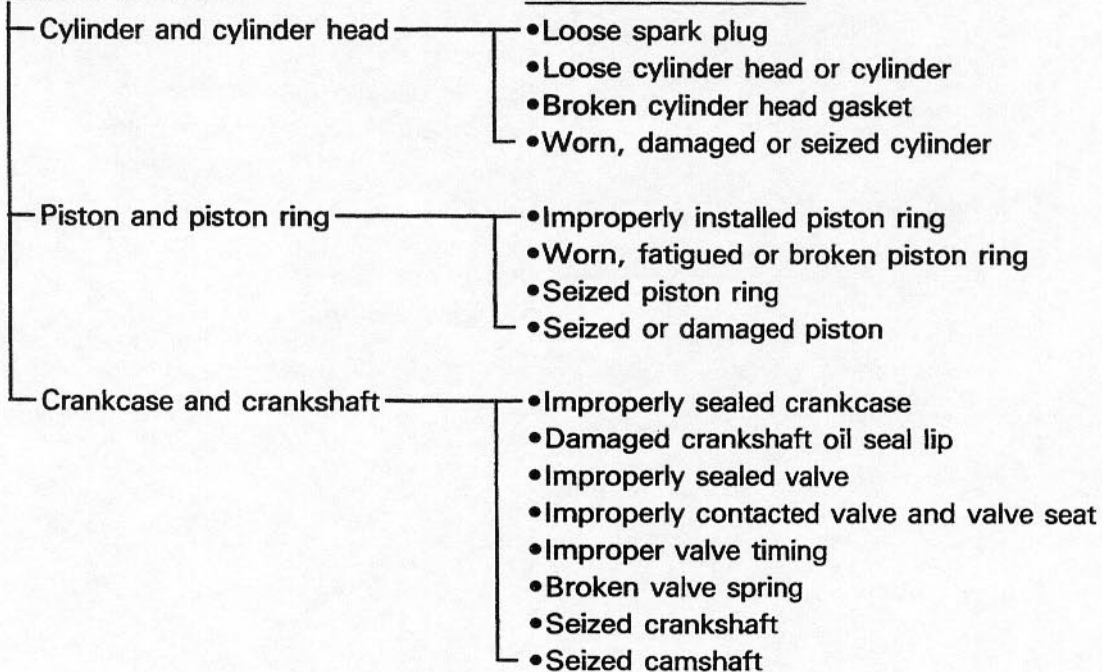

# POOR IDLE SPEED PERFORMANCE/ POOR MEDIUM AND HIGH SPEED PERFORMANCE

TRBL SHTG	?
--------------	---

## POOR IDLE SPEED PERFORMANCE

### POOR IDLE SPEED PERFORMANCE

### PROBABLE CAUSE

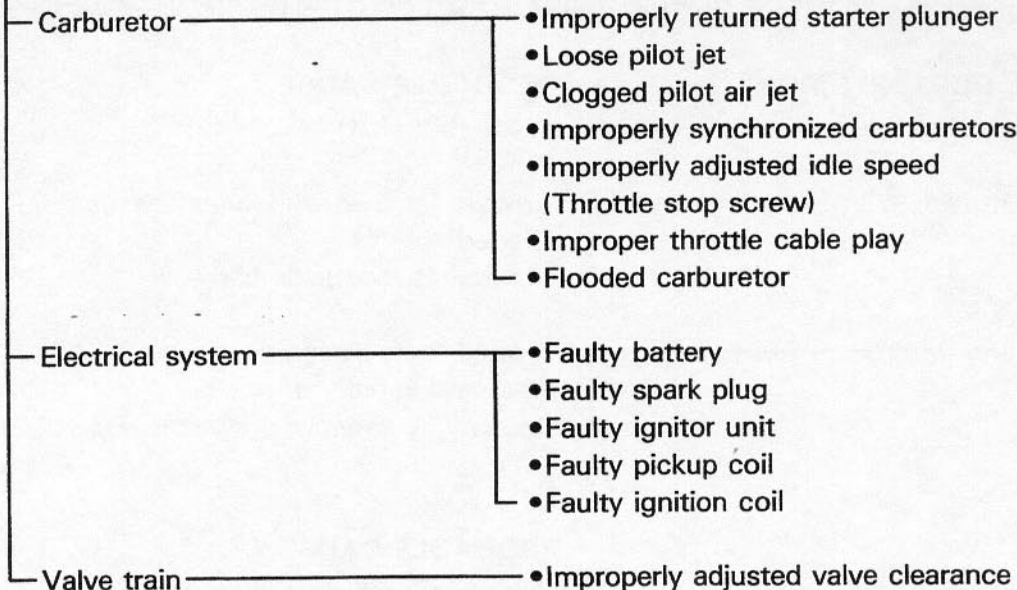

## POOR MEDIUM AND HIGH SPEED PERFORMANCE

### POOR MEDIUM AND HIGH SPEED PERFORMANCE

Refer to the "STARTING FAILURE/HARD STARTING" and "POOR IDLE SPEED PERFORMANCE-valve train" section.

### PROBABLE CAUSE

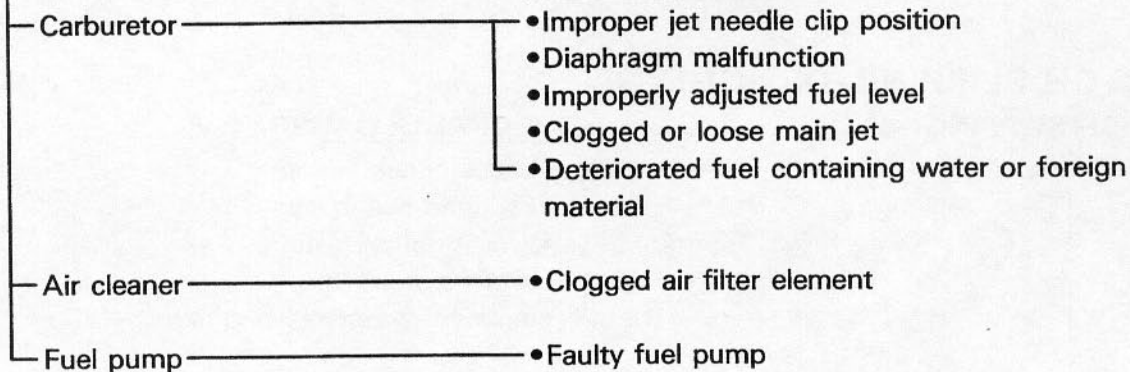



**FAULTY GEAR SHIFTING**

**HARD SHIFTING**

Refer to the "CLUTCH SLIPPING/Dragging-CLUTCH Dragging" section.

**SHIFT PEDAL DOES NOT MOVE**

**PROBABLE CAUSE**

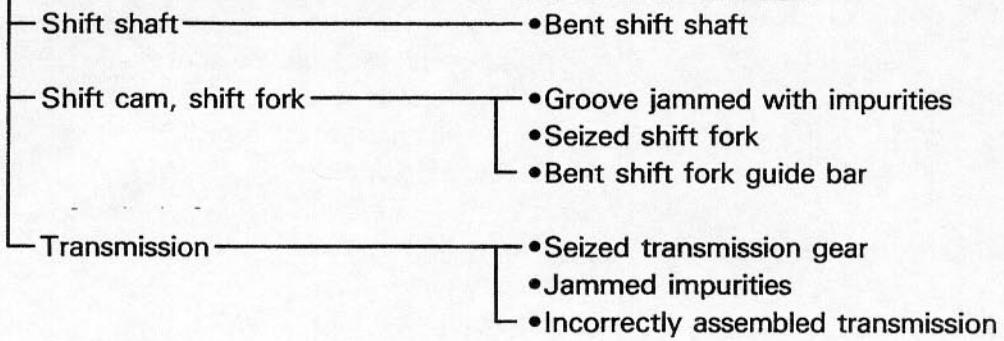

**JUMP-OUT GEAR**

**PROBABLE CAUSE**

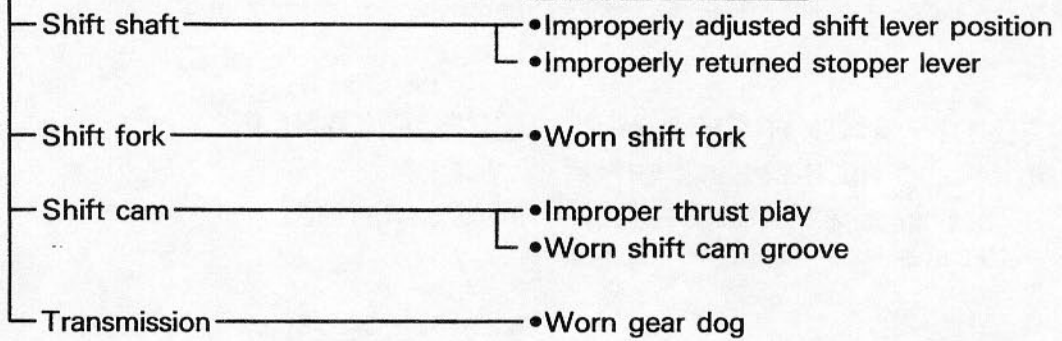

**CLUTCH SLIPPING/Dragging**

**CLUTCH SLIPPING**

**PROBABLE CAUSE**

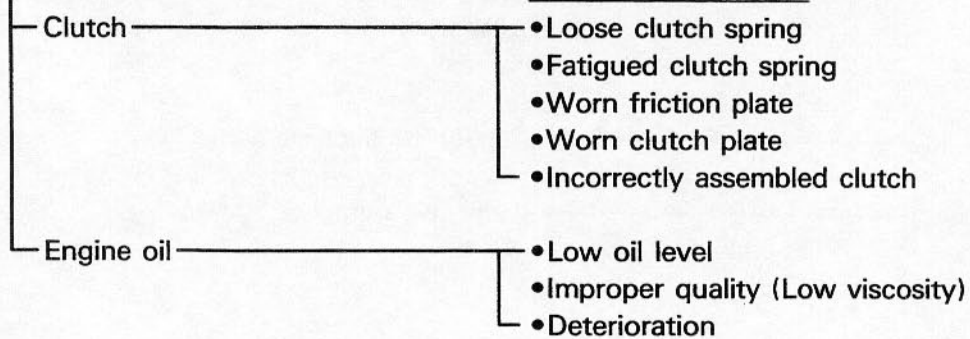

# OVERHEATING OR OVER-COOLING

TRBL  
SHTG ?

## CLUTCH DRAGGING

### PROBABLE CAUSE

- Clutch
  - Warped pressure plate
  - Unevenly tensioned clutch springs
  - Match marks not aligned
  - Loose clutch boss nut
  - Burnt primary driven gear bushing
  - Bent clutch plate
  - Swollen friction plate
  - Broken clutch boss
- Engine oil
  - High oil level
  - Improper quality (High viscosity)
  - Deterioration

## OVERHEATING OR OVER-COOLING

### OVERHEATING

### PROBABLE CAUSE

- Ignition system
  - Improper spark plug gap
  - Improper spark plug heat range
  - Faulty ignitor unit
- Fuel system
  - Improper carburetor main jet (Improper setting)
  - Improperly adjusted fuel level
  - Clogged air filter element
- Compression system
  - Heavy carbon build-up
- Engine oil
  - Incorrect oil level
  - Improper oil viscosity
  - Inferior oil quality
- Brake
  - Dragging brake
- Cooling system
  - Faulty water temperature gauge
  - Faulty thermo unit
  - Incorrect coolant level
  - Faulty thermostat
  - Faulty thermo switch
  - Clogged or damaged radiator
  - Faulty radiator cap
  - Seized impeller shaft
  - Inoperative fan motor

### OVER-COOLING

### PROBABLE CAUSE

- Cooling system
  - Faulty water temperature gauge
  - Faulty thermo unit
  - Faulty thermostat
  - Faulty thermo switch
  - Inoperative fan motor

**FAULTY BRAKE**

**POOR BRAKING EFFECT**

└ Disc brake

**PROBABLE CAUSE**

- Worn brake pad
- Worn brake disc
- Air in brake fluid
- Leaking brake fluid
- Faulty cylinder kit cup
- Faulty caliper kit seal
- Loose union bolt
- Broken brake hose
- Oily or greasy brake disc
- Oily or greasy brake pad
- Improper brake fluid level

**FRONT FORK OIL LEAKAGE AND FRONT FORK MALFUNCTION**

**OIL LEAKAGE**

**PROBABLE CAUSE**

- Bent, damaged or rusty inner tube
- Damaged or cracked outer tube
- Damaged oil seal lip
- Improperly installed oil seal
- Improper oil level (too much)
- Loose damper rod holding bolt
- Broken cap bolt O-ring
- Loose drain bolt
- Damaged drain bolt gasket

**MALFUNCTION**

**PROBABLE CAUSE**

- Bent, deformed or damaged inner tube
- Bent or deformed outer tube
- Damaged fork spring
- Worn or damaged guide bush
- Bent or damaged damper rod
- Improper oil viscosity
- Improper oil level



**INSTABLE HANDLING**

**INSTABLE HANDLING**

**PROBABLE CAUSE**

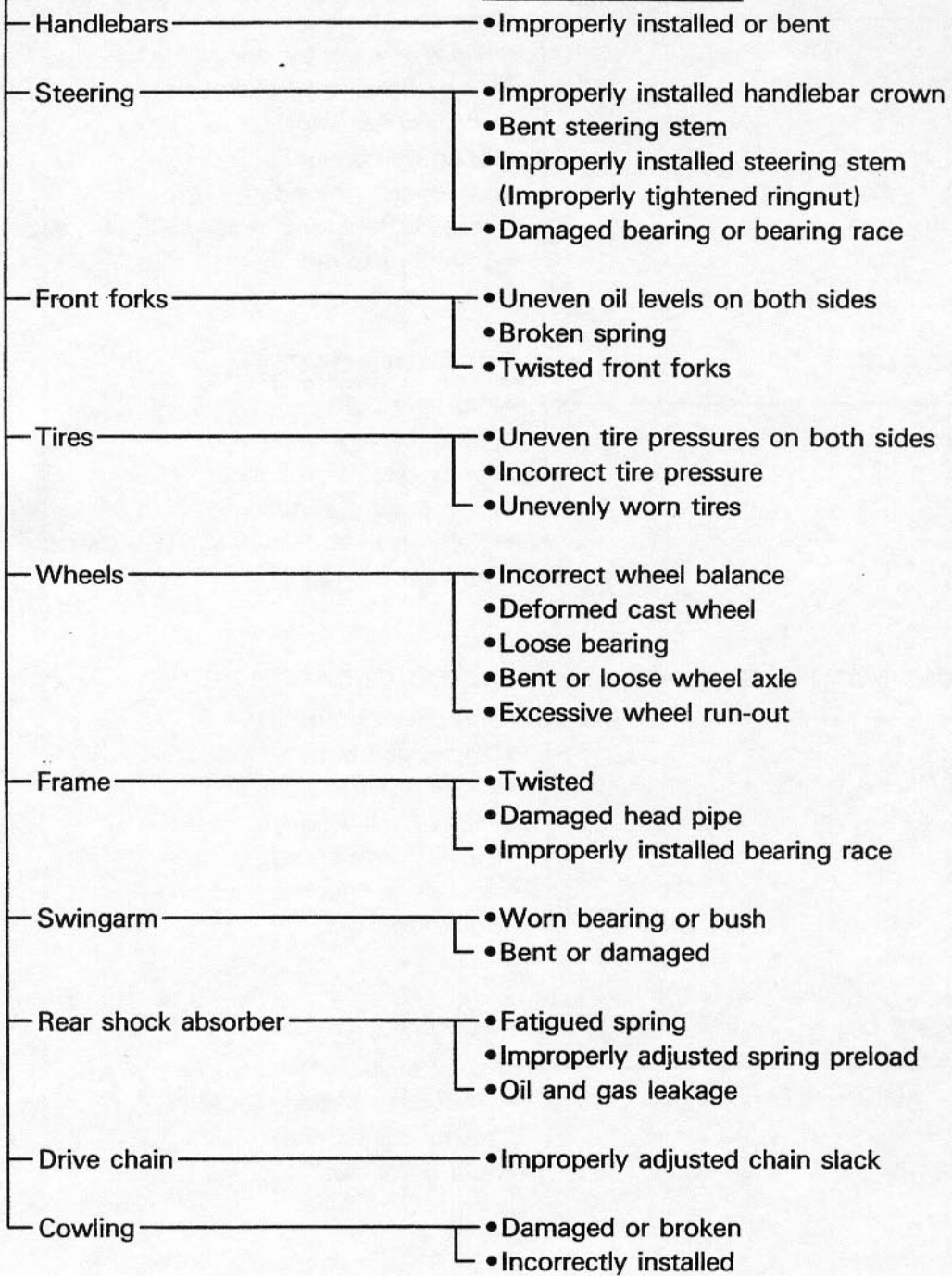

**FAULTY SIGNAL AND LIGHTING SYSTEM**

**HEADLIGHT DARK**

**PROBABLE CAUSE**

- Improper bulb
- Too many electric accessories
- Hard charging (Broken stator coil and/or faulty rectifier/regulator)
- Incorrect connection
- Improperly grounded
- Poor contacts (main or "LIGHTS" switch)
- Bulb life expired

**BULB BURNT OUT**

**PROBABLE CAUSE**

- Improper bulb
- Faulty battery
- Faulty rectifier/regulator
- Improperly grounded
- Faulty main and/or "LIGHTS" switch
- Bulb life expired

**FLASHER DOES NOT LIGHT**

**PROBABLE CAUSE**

- Improperly grounded
- Discharged battery
- Faulty "TURN" switch
- Faulty flasher relay
- Broken wireharness
- Loosely connected coupler
- Bulb burnt out

**FLASHER KEEPS ON**

**PROBABLE CAUSE**

- Faulty flasher relay
- Insufficient battery capacity (nearly discharged)
- Bulb burnt out

# FAULTY SIGNAL AND LIGHTING SYSTEM

TRBL SHTG	?
--------------	---

**FLASHER WINKS SLOWER**

**PROBABLE CAUSE**

- Faulty flasher relay
- Insufficient battery capacity (nearly discharged)
- Improper bulb
- Faulty main and/or "TURN" switch

**FLASHER WINKS QUICKER**

**PROBABLE CAUSE**

- Improper bulb
- Faulty flasher relay

**HORN IS INOPERATIVE**

**PROBABLE CAUSE**

- Faulty battery
- Faulty main and/or "HORN" switch
- Improperly adjusted horn
- Faulty horn
- Broken wireharness



# B-9

## XTZ560 WIRING DIAGRAM

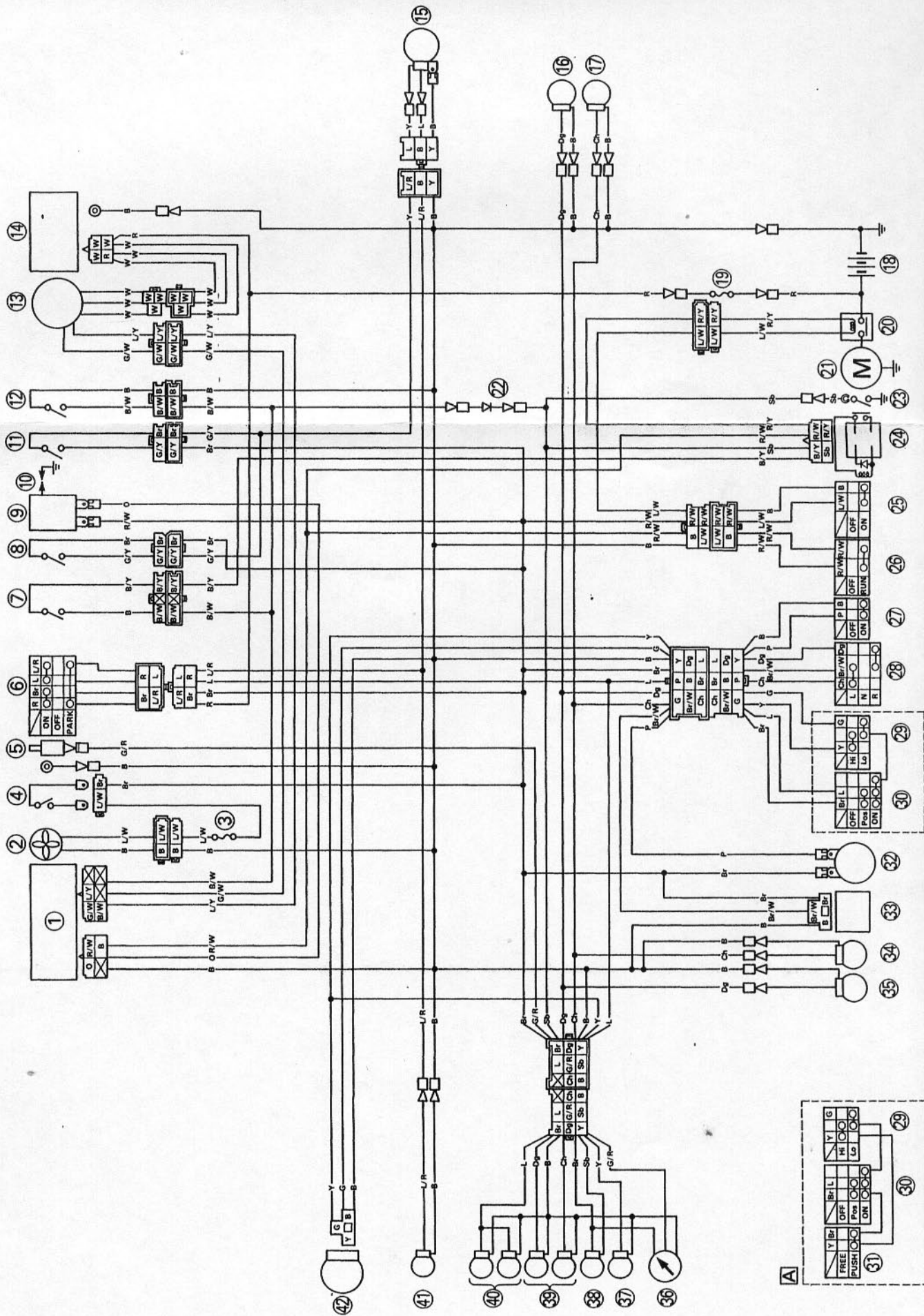

- ① Ignitor unit
- ② Fan motor
- ③ Fuse (Fan motor)
- ④ Thermo switch
- ⑤ Thermo unit
- ⑥ Main switch
- ⑦ Clutch switch
- ⑧ Front brake switch
- ⑨ Ignition coil
- ⑩ Spark plug
- ⑪ Rear brake switch
- ⑫ Sidestand switch
- ⑬ A.C. magneto generator
- ⑭ Rectifier/regulator
- ⑮ Tail/brake light
- ⑯ Rear flasher light (Right)
- ⑰ Rear flasher light (Left)
- ⑱ Battery
- ⑲ Fuse (Main)
- ⑳ Starter relay
- ㉑ Starter motor
- ㉒ Diode
- ㉓ Neutral switch
- ㉔ Starting circuit cut-off relay
- ㉕ "START" switch
- ㉖ "ENGINE STOP" switch
- ㉗ "HORN" switch
- ㉘ "TURN" switch
- ㉙ "LIGHTS" (Dimmer) switch
- ㉚ "LIGHTS" switch
- ㉛ "PASS" switch (for Austria/Switzerland)
- ㉜ Horn
- ㉝ Flasher relay
- ㉞ Front flasher light (Left)
- ㉟ Front flasher light (Right)
- ㊱ Temperature gauge
- ㊲ "HIGH BEAM" indicator light
- ㊳ "NEUTRAL" indicator light
- ㊴ "TURN" indicator light
- ㊵ Meter light
- ㊶ Auxiliary light
- ㊷ Headlight

Ⓐ For Austria/Switzerland

#### COLOR CODE

B .....	Black	B/W .....	Black/White
Br .....	Brown	B/Y .....	Black/Yellow
Ch .....	Chocolate	Br/W .....	Brown/White
Dg .....	Dark green	G/R .....	Green/Red
G .....	Green	G/W .....	Green/White
L .....	Blue	G/Y .....	Green/Yellow
O .....	Orange	L/R .....	Blue/Red
P .....	Pink	L/W .....	Blue/White
R .....	Red	L/Y .....	Blue/Yellow
Sb .....	Sky blue	R/W .....	Red/White
W .....	White	R/Y .....	Red/Yellow
Y .....	Yellow		

