



YAMAHA

TDR

'88

SERVICE MANUAL

3CK-28197-20

NOTICE

This manual was written by the Yamaha Motor Company primarily for use by Yamaha dealers and their qualified mechanics. It is not possible to put an entire mechanic's education into one manual, so it is assumed that persons using this book to perform maintenance and repairs on Yamaha motorcycles have a basic understanding of the mechanical concepts and procedures inherent in motorcycle repair technology. Without such knowledge, attempted repairs or service to this model may render it unfit to use and/or unsafe.

Yamaha Motor Company, Ltd. is continually striving to improve all models manufactured by Yamaha. Modifications and significant changes in specifications or procedures will be forwarded to all Authorized Yamaha dealers and will, where applicable, appear in future editions of this manual.

TECHNICAL PUBLICATIONS
SERVICE DIVISION
MOTORCYCLE GROUP
YAMAHA MOTOR CO., LTD.

HOW TO USE THIS MANUAL

PARTICULARLY IMPORTANT INFORMATION

This material is distinguished by the following notation.

NOTE: A **NOTE** provides key information to make procedures easier or clearer.

CAUTION:

A **CAUTION** indicates special procedures that must be followed to avoid damage to the motorcycle.

WARNING:

A **WARNING** indicates special procedures that must be followed to avoid injury to a motorcycle operator or person inspecting or repairing the motorcycle.

MANUAL FORMAT

All of the procedures in this manual are organized in a sequential, step-by-step format. The information has been compiled to provide the mechanic with an easy to read, handy reference that contains comprehensive explanations of all disassembly, repair, assembly, and inspection operations.



















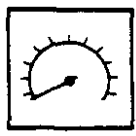
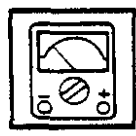

In this revised format, the condition of a faulty component will precede an arrow symbol and the course of action required will follow the symbol, e.g.,

•Bearings

Pitting/Damage → Replace.

EXPLODED DIAGRAM

Each chapter provides exploded diagrams before each disassembly section for ease in identifying correct disassembly and assembly procedures.

① GEN INFO 	② SPEC 	
③ INSP ADJ 	④ ENG 	
⑤ COOL 	⑥ CARB 	
⑦ CHAS 	⑧ ELEC 	
⑨ TRBL SHTG ?	⑩ 	
⑪ 	⑫ 	
⑬ 	⑭ 	
⑮ 	⑯ 	
⑰ 	⑱ 	⑲ 
⑳ 	㉑ 	㉒ 
㉓ 		

ILLUSTRATED SYMBOLS (Refer to the illustration)

Illustrated symbols ① to ⑨ are designed as thumb tabs to indicate the chapter's number and content.

- ① General information
- ② Specifications
- ③ Periodic inspection and adjustment
- ④ Engine
- ⑤ Cooling system
- ⑥ Carburetion
- ⑦ Chassis
- ⑧ Electrical
- ⑨ Troubleshooting









Illustrated symbols ⑩ to ⑯ are used to identify the specifications appearing in the text.

- ⑩ Filling fluid
- ⑪ Lubricant
- ⑫ Special tool
- ⑬ Tightening
- ⑭ Wear limit, clearance
- ⑮ Engine speed
- ⑯ Ω , V, A

Illustrated symbols ⑰ to ㉓ in the exploded diagram indicate grade of lubricant and location of lubrication point.

- ⑰ Apply engine oil
- ⑱ Apply gear oil
- ⑲ Apply molybdenum disulfide oil
- ⑳ Apply wheel bearing grease
- ㉑ Apply lightweight lithium-soap base grease
- ㉒ Apply molybdenum disulfide grease
- ㉓ Apply locking agent (LOCTITE®)

INDEX

GENERAL INFORMATION	 GEN INFO 1
SPECIFICATIONS	 SPEC 2
PERIODIC INSPECTION AND ADJUSTMENT	 INSP ADJ 3
ENGINE OVERHAUL	 ENG 4
COOLING SYSTEM	 COOL 5
CARBURETION	 CARB 6
CHASSIS	 CHAS 7
ELECTRICAL	 ELEC 8
TROUBLESHOOTING	? TRBL SHTG 9

CONTENTS

CHAPTER 1. GENERAL INFORMATION

MOTORCYCLE IDENTIFICATION	1-1
FRAME SERIAL NUMBER	1-1
ENGINE SERIAL NUMBER	1-1
IMPORTANT INFORMATION	1-2
PREPARATION FOR REMOVAL AND DISASSEMBLY	1-2
ALL REPLACEMENT PARTS	1-3
GASKETS, OIL SEALS, AND O-RINGS	1-3
LOCK WASHERS/PLATES AND COTTER PINS	1-3
BEARINGS AND OIL SEALS	1-3
CIRCLIPS	1-4
SPECIAL TOOLS	1-4
FOR TUNE UP	1-4
FOR ENGINE SERVICE	1-5
FOR CHASSIS SERVICE	1-6
FOR ELECTRICAL COMPONENTS	1-6

CHAPTER 2. SPECIFICATIONS

GENERAL SPECIFICATIONS	2-1
MAINTENANCE SPECIFICATIONS	2-5
ENGINE	2-5
CHASSIS	2-12
ELECTRICAL	2-17
GENERAL TORQUE SPECIFICATIONS	2-19
DEFINITION OF UNITS	2-19
LUBRICATION POINTS AND LUBRICANT TYPE	2-20
ENGINE	2-20
CHASSIS	2-21
LUBRICATION DIAGRAM	2-22
COOLANT FLOW CHART	2-23
CABLE ROUTING	2-25

CHAPTER 3. PERIODIC INSPECTION AND ADJUSTMENT

INTRODUCTION	3-1
PERIODIC MAINTENANCE/LUBRICATION INTERVALS	3-1
COWLINGS	3-3
REMOVAL	3-3
INSTALLATION	3-4
SIDE COVERS	3-4
REMOVAL	3-4
INSTALLATION	3-4
ENGINE	3-5
YPVS CABLE ADJUSTMENT	3-5
CARBURETOR SYNCHRONIZATION	3-7
IDLE SPEED ADJUSTMENT	3-8
THROTTLE CABLE FREE PLAY ADJUSTMENT	3-9
AUTOLUBE PUMP CABLE ADJUSTMENT	3-10
AUTOLUBE PUMP STROKE ADJUSTMENT	3-11
AUTOLUBE PUMP AIR BLEEDING	3-12
SPARK PLUG INSPECTION	3-13
IGNITION TIMING CHECK	3-15
ENGINE OIL LEVEL CHECK	3-16
TRANSMISSION OIL LEVEL INSPECTION	3-17
TRANSMISSION OIL REPLACEMENT	3-17
CLUTCH ADJUSTMENT	3-18
AIR FILTER CLEANING	3-19
CARBURETOR JOINT INSPECTION	3-20
FUEL LINE INSPECTION	3-21
EXHAUST SYSTEM INSPECTION	3-22
COOLANT LEVEL INSPECTION	3-23
COOLANT REPLACEMENT	3-24
COOLING SYSTEM INSPECTION	3-28
CHASSIS	3-28
FRONT BRAKE ADJUSTMENT	3-28
REAR BRAKE ADJUSTMENT	3-29
BRAKE FLUID INSPECTION	3-29
BRAKE PAD INSPECTION	3-30
BRAKE LIGHT SWITCH ADJUSTMENT	3-31
BRAKE HOSE INSPECTION	3-31
AIR BLEEDING	3-31
DRIVE CHAIN SLACK ADJUSTMENT	3-32
DRIVE CHAIN LUBRICATION	3-34
STEERING HEAD ADJUSTMENT	3-34
FRONT FORK INSPECTION	3-36



**GEN
INFO**



SPEC



**INSP
ADJ**



ENG



COOL



CARB



CHAS



ELEC



**TRBL
SHTG**

FRONT FORK ADJUSTMENT	3-37
REAR SHOCK ABSORBER ADJUSTMENT	3-38
RECOMMENDED COMBINATIONS OF FRONT FORK AND REAR SHOCK ABSORBER SETTINGS	3-40
TIRE INSPECTION	3-40
WHEEL INSPECTION	3-43
SPOKES INSPECTION AND TIGHTENING	3-43
CABLE INSPECTION AND LUBRICATION	3-44
LEVER AND PEDAL LUBRICATION	3-44
SIDESTAND LUBRICATION	3-44
ELECTRICAL	3-45
BATTERY INSPECTION	3-45
CIRCUIT BREAKER INSPECTION	3-47
HEADLIGHT BEAM ADJUSTMENT	3-49
HEADLIGHT BULB REPLACEMENT	3-49

CHAPTER 4. ENGINE OVERHAUL

ENGINE REMOVAL	4-1
COWLINGS	4-1
SEAT AND SIDE COVERS	4-1
TRANSMISSION OIL	4-1
COOLANT	4-1
MUFFLER ASSEMBLY	4-2
FUEL TANK (WITH OIL TANK)	4-2
CARBURETOR	4-3
AUTOLUBE PUMP CABLE AND HOSE	4-3
CLUTCH CABLE	4-4
YPVS CABLES	4-4
RADIATOR	4-5
LEADS	4-5
DRIVE CHAIN	4-6
ENGINE REMOVAL	4-7
ENGINE DISASSEMBLY	4-8
CYLINDER HEAD, CYLINDERS AND PISTONS	4-8
CLUTCH	4-10
PRIMARY DRIVE GEAR	4-11
KICK AXLE AND KICK IDLE GEAR	4-12
SHIFT SHAFT	4-13
CDI MAGNETO	4-13
CRANKCASE (UPPER)	4-15
TRANSMISSION, SHIFTER AND CRANKSHAFT	4-15
POWER VALVES	4-17
OIL PUMP AND STRAINER	4-17

INSPECTION AND REPAIR	4-19
CYLINDER HEAD	4-19
CYLINDER AND PISTON	4-20
PISTON RINGS	4-22
PISTON PIN AND BEARING	4-22
CLUTCH	4-23
PRIMARY DRIVE	4-25
TRANSMISSION AND SHIFTER	4-25
KICK STARTER	4-26
SHIFT SHAFT	4-27
OIL PUMP	4-27
AUTOLUBE PUMP	4-27
CRANKSHAFT	4-28
CRANKCASE	4-29
OIL PIPE AND STRAINER	4-29
POWER VALVE	4-30
ENGINE ASSEMBLY AND ADJUSTMENT	4-31
OIL PUMP AND STRAINER	4-31
POWER VALVES	4-33
TRANSMISSION, SHIFTER AND CRANKSHAFT	4-35
CRANKCASE (UPPER)	4-41
CDI MAGNETO	4-42
SHIFT SHAFT	4-45
KICK AXLE AND KICK IDLE GEAR	4-47
CLUTCH	4-49
PRIMARY DRIVE GEAR	4-49
CYLINDER HEAD, CYLINDERS AND PISTONS	4-53
REMountING ENGINE	4-57

CHAPTER 5. COOLING SYSTEM

WATER PUMP	5-1
REMOVAL	5-2
INSPECTION	5-4
INSTALLATION	5-4
RADIATOR	5-6
REMOVAL	5-7
INSPECTION	5-9
INSTALLATION	5-10
THERMOSTAT	5-12
REMOVAL	5-13
INSPECTION	5-14
INSTALLATION	5-15

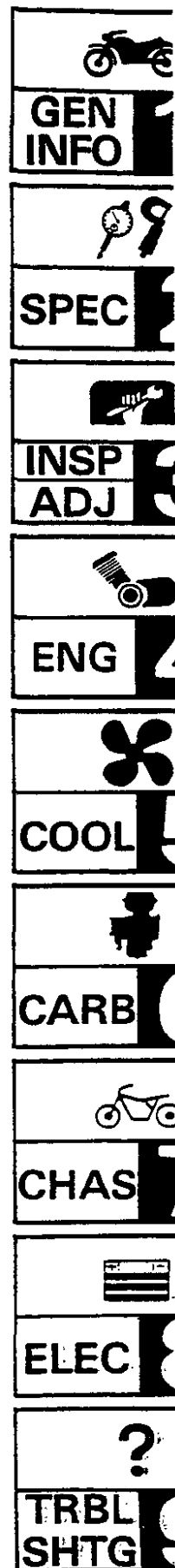

CHAPTER 6. CARBURETION

CARBURETOR	6-1
SECTION VIEW	6-2
REMOVAL	6-3
DISASSEMBLY	6-5
INSPECTION	6-7
INSTALLATION	6-10
FUEL LEVEL ADJUSTMENT	6-11
REED VALVE	6-13
REMOVAL	6-14
DISASSEMBLY	6-15
INSPECTION	6-16
ASSEMBLY	6-16
INSTALLATION	6-17

CHAPTER 7. CHASSIS

FRONT WHEEL	7-1
REMOVAL	7-2
INSPECTION	7-2
INSTALLATION	7-4
STATIC WHEEL BALANCE ADJUSTMENT	7-4
REAR WHEEL	7-7
REMOVAL	7-8
INSPECTION	7-8
INSTALLATION	7-9
STATIC WHEEL BALANCE ADJUSTMENT	7-10
FRONT AND REAR BRAKE	7-11
BRAKE PAD REPLACEMENT	7-13
CALIPER DISASSEMBLY	7-17
MASTER CYLINDER DISASSEMBLY	7-19
INSPECTION AND REPAIR	7-21
ASSEMBLY	7-22
FRONT FORK	7-29
REMOVAL	7-30
DISASSEMBLY	7-31
INSPECTION	7-32
ASSEMBLY	7-33
INSTALLATION	7-35
STEERING HEAD AND HANDLEBARS	7-37
REMOVAL	7-38

INSPECTION	7-40
INSTALLATION	7-41
REAR SHOCK ABSORBER AND SWINGARM	7-45
HANDLING NOTES	7-46
NOTES ON DISPOSAL	7-46
REMOVAL	7-47
INSPECTION	7-49
INSTALLATION	7-50
DRIVE CHAIN AND SPROCKETS	7-53
REMOVAL	7-53
INSPECTION	7-54
INSTALLATION	7-55

CHAPTER 8. ELECTRICAL

TDR CIRCUIT DIAGRAM	8-1
COLOR CODE	8-2
ELECTRICAL COMPONENTS	8-3
CHECKING OF SWITCHES	8-5
SWITCH CONNECTION AS SHOWN IN MANUAL	8-5
CHECKING SWITCH FOR TERMINAL CONNECTION	8-5
CHECKING OF BULBS	8-8
KINDS OF BULBS	8-8
CHECKING BULB CONDITION	8-8
IGNITION AND STARTING SYSTEM	8-11
CIRCUIT DIAGRAM	8-11
TROUBLESHOOTING	8-13
CHARGING SYSTEM	8-21
CIRCUIT DIAGRAM	8-21
TROUBLESHOOTING	8-23
LIGHTING SYSTEM	8-27
CIRCUIT DIAGRAM	8-27
TROUBLESHOOTING	8-29
LIGHTING SYSTEM CHECK	8-32
SIGNAL SYSTEM	8-37
CIRCUIT DIAGRAM	8-37
TROUBLESHOOTING	8-39
SIGNAL SYSTEM CHECK	8-41

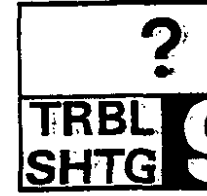
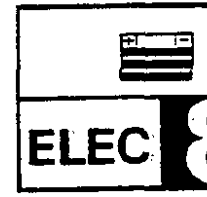
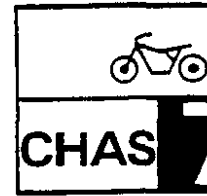
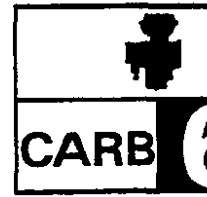
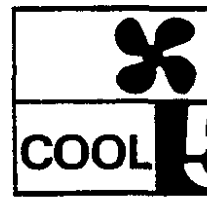
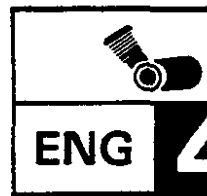
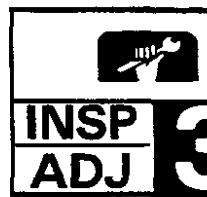
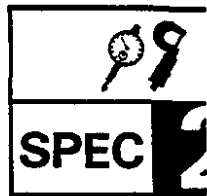









COOLING SYSTEM	8-53
CIRCUIT DIAGRAM	8-53
TROUBLESHOOTING	8-55
YAMAHA POWER VALVE SYSTEM	8-59
CIRCUIT DIAGRAM	8-59
TROUBLESHOOTING	8-61

CHAPTER 9. TROUBLESHOOTING

STARTING FAILURE/HARD STARTING	9-1
FUEL SYSTEM	9-1
ELECTRICAL SYSTEM.....	9-2
COMPRESSION SYSTEM	9-3
POOR IDLE SPEED PERFORMANCE	9-3
POOR IDLE SPEED PERFORMANCE.....	9-3
POOR MEDIUM AND HIGH SPEED PERFORMANCE	9-4
FUEL SYSTEM	9-4
ELECTRICAL SYSTEM.....	9-4
COMPRESSION SYSTEM	9-5
YPVS	9-5
FAULTY GEAR SHIFTING	9-6
HARD SHIFTING.....	9-6
CHANGE PEDAL DOES NOT MOVE.....	9-6
JUMP-OUT GEAR	9-6
CLUTCH SLIPPING/Dragging	9-7
CLUTCH SLIPPING.....	9-7
CLUTCH DRAGGING	9-7
IMPROPER KICKING	9-8
SLIPPING	9-8
HARD KICKING	9-8
KICK CRANK NOT RETURNING	9-8
FAULTY BRAKE	9-9
POOR BRAKING EFFECT	9-9
FRONT FORK OIL LEAKAGE AND FRONT FORK MALFUNCTION	9-9
OIL LEAKAGE	9-9
MALFUNCTION	9-9
INSTABLE HANDLING	9-10
INSTABLE HANDLING	9-10

FAULTY SIGNAL AND LIGHTING SYSTEM	9-11
HEADLIGHT DARK	9-11
BULB BURNT OUT	9-11
FLASHER DOES NOT LIGHT	9-11
FLASHER KEEPS ON	9-11
FLASHER WINKS SLOWER	9-12
FLASHER WINKS QUICKER	9-12
HORN IS INOPERATIVE	9-12
FAULTY YPVS	9-12
FAULTY YPVS	9-12
OVERHEATING OR OVER-COOLING	9-13
OVERHEATING	9-13
OVER-COOLING	9-13
TDR WIRING DIAGRAM	9-14

	
GEN INFO	1
	
SPEC	2
	
INSP ADJ	3
	
ENG	4
	
COOL	5
	
CARB	6
	
CHAS	7
	
ELEC	8
	
TRBL SHTG	9

GENERAL INFORMATION

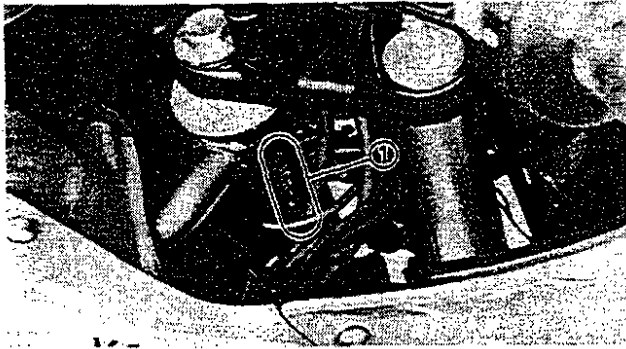

**MOTORCYCLE IDENTIFICATION
FRAME SERIAL NUMBER**

The frame serial number ① is stamped into the right side of the steering head pipe.

Starting Serial Number:
Except for France
TDR250.....3CK-000101
For France
TDR240.....3CL-000101

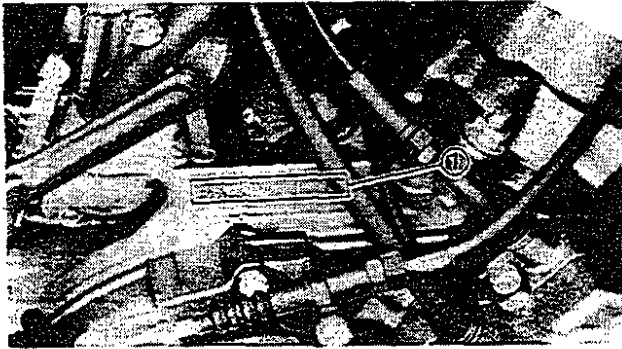

ENGINE SERIAL NUMBER

The engine serial number ① is stamped into the elevated part of the right rear section of the engine.

Starting Serial Number:
Except for France
TDR250.....3CK-000101
For France
TDR240.....3CL-000101

NOTE: _____

- The first three digits of these numbers are for model identifications; the remaining digits are the unit production number.
- Designs and specifications are subject to change without notice.

IMPORTANT INFORMATION

PREPARATION FOR REMOVAL AND
DISASSEMBLY

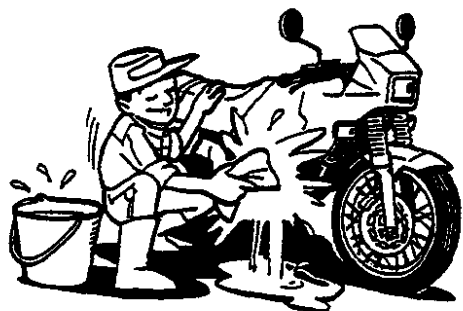

1. Remove all dirt, mud, dust and foreign material before removing and disassembling.

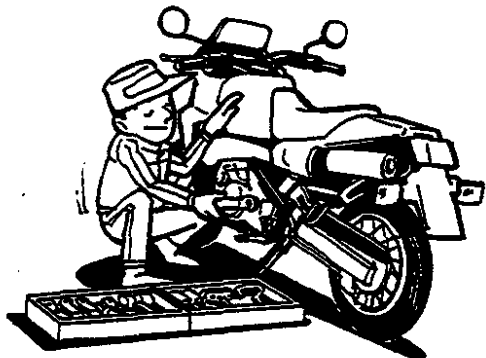

2. Use proper tools and cleaning equipment. Refer to "SPECIAL TOOL"



3. When disassembling the motorcycle, keep mated parts together. This includes gears, cylinders, pistons, and other mated parts that have been "mated" through normal wear. Mated parts must be reused as an assembly or replaced.

4. During the motorcycle disassembly, clean all parts and place them in trays in the order of disassembly. This will speed up assembly time and help assure that all parts are correctly reinstalled.



5. Keep away from fire.

ALL REPLACEMENT PARTS

1. Use only genuine Yamaha parts for all replacements. Use oil and/or grease recommended by Yamaha for assembly and adjustment. Other brands may be similar in function and appearance, but inferior in quality.

GASKETS, OIL SEALS, AND O-RINGS

1. All gaskets, seals and O-rings should be replaced when an engine is overhauled. All gasket surfaces, oil seal lips and O-rings must be cleaned.
2. Properly oil all mating parts and bearings during reassembly. Apply grease to the oil seal lips.

LOCK WASHERS/PLATES AND COTTER PINS

1. All lock washers/Plates ① and cotter pins must be replaced when they are removed. Lock tab(s) should be bent along the bolt or nut flat(s) after the bolt or nut has been properly tightened.

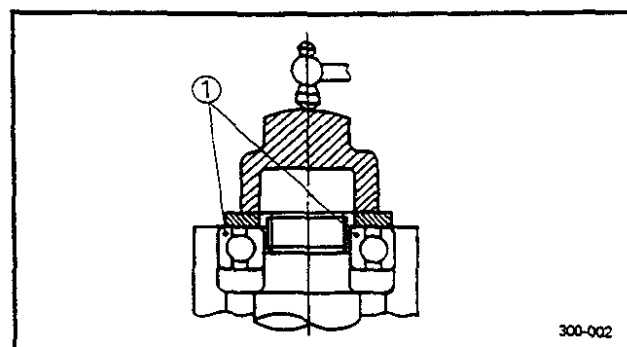
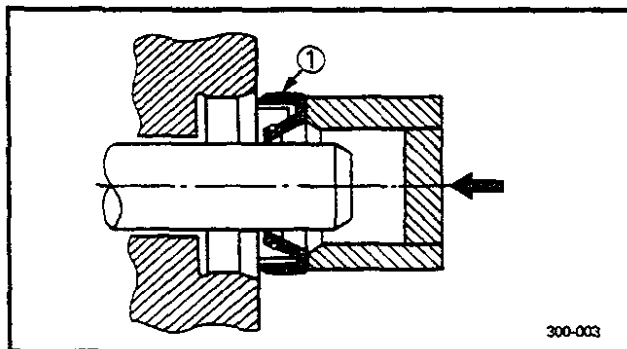
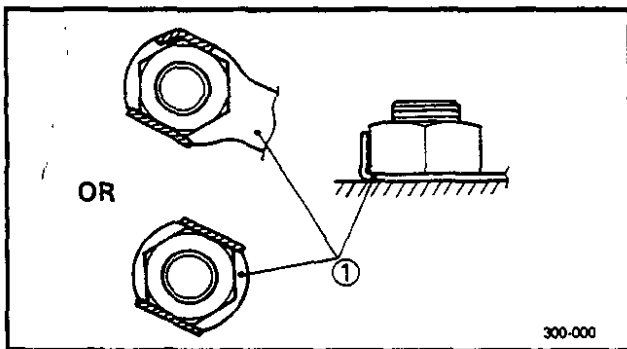

BEARINGS AND OIL SEALS

1. Install the bearing(s) and oil seal(s) with their manufacturer's marks or numbers facing outward. (In other words, the stamped letters must be on the side exposed to view.) When installing oil seal(s), apply a light coating of light-weight lithium base grease to the seal lip(s). Oil the bearings liberally when installing.

① Oil seal

CAUTION:

Do not use compressed air to spin the bearings dry. This causes damage to the bearing surfaces.

① Bearing

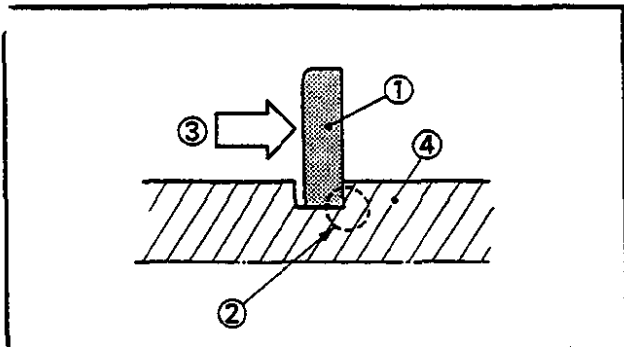

CIRCLIPS

1. All circlips should be inspected carefully before reassembly. Always replace piston pin clips after one use. Replace distorted circlips. When installing a circlip (1), make sure that the sharp-edged corner (2) is positioned opposite to the thrust (3) it receives. See the sectional view.

(4) Shaft

SPECIAL TOOLS

The proper special tools are necessary for complete and accurate tune-up and assembly. Using the correct special tool will help prevent damage caused by the use of improper tools or improvised techniques.

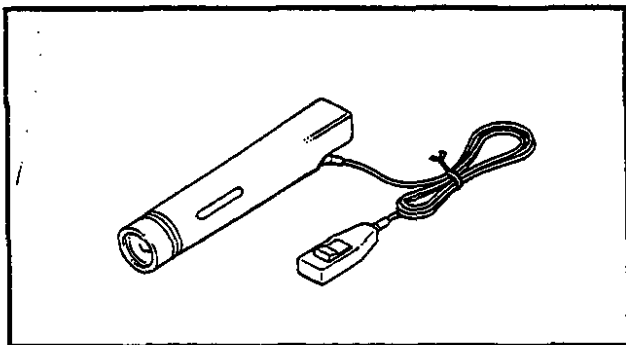

FOR TUNE UP

1. Inductive Timing Light
P/N. 90890-03109

This tool is necessary for adjusting ignition timing.

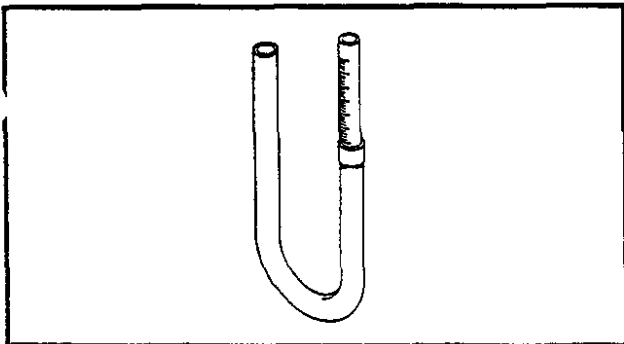

2. Fuel Level Gauge
P/N. 90890-01312

This gauge is used to measure the fuel level in the float chamber.

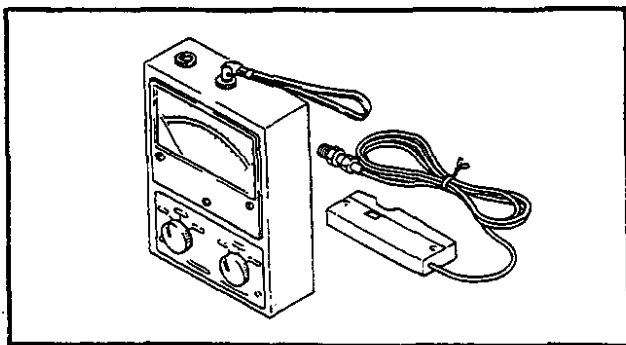

3. Inductive Tachometer
P/N. 90890-03113

This tool is needed for detecting engine rpm.

SPECIAL TOOLS

GEN
INFO

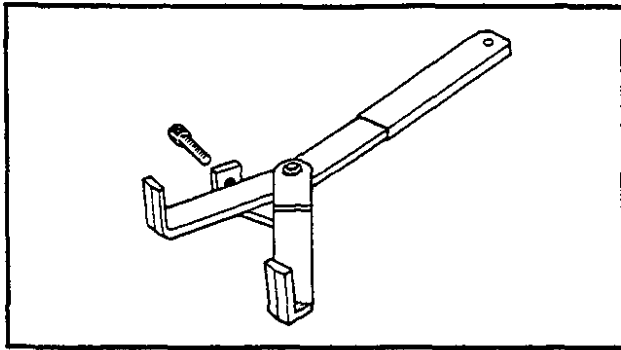

FOR ENGINE SERVICE

1. Universal Clutch Holder
P/N. 90890-04086

This tool is used to hold the clutch when loosening or tightening the clutch boss locknut.

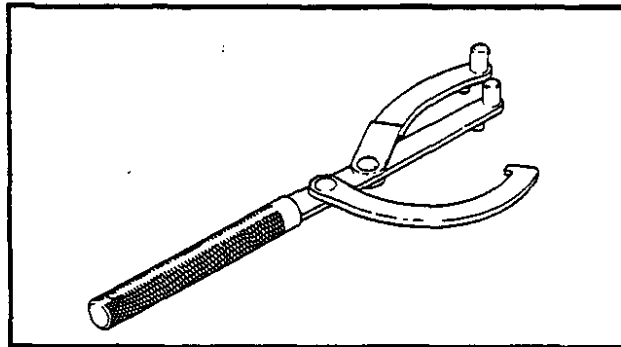

2. Universal Rotor Holder
P/N. 90890-01235

This tool is used when loosening or tightening the flywheel magneto securing bolt.

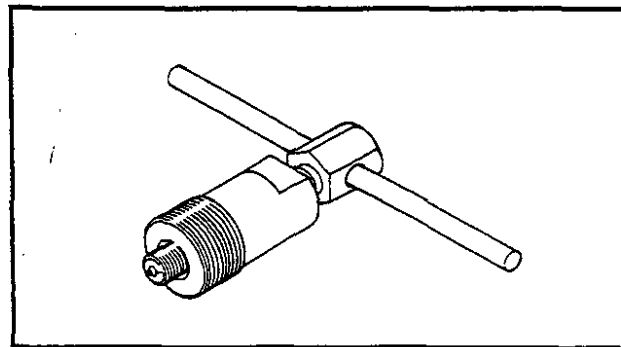

3. Flywheel Puller
P/N. 90890-01189

This tool is used for removing the flywheel.

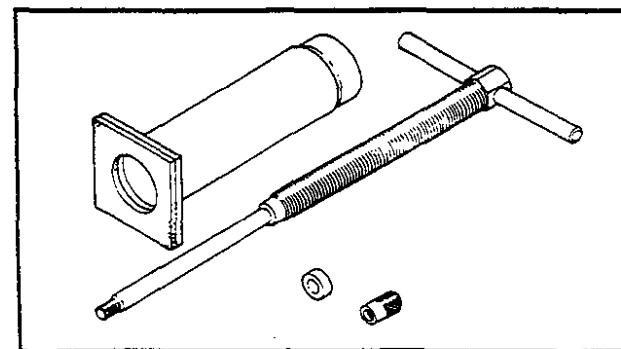

4. Piston Pin Puller
P/N. 90890-01304

This tool is used to remove the piston pin.

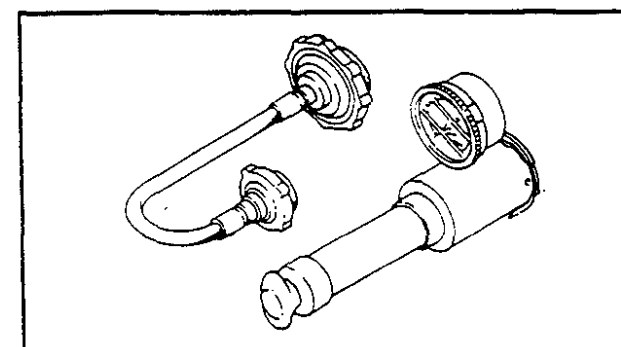

5. Cooling System Tester
P/N. 90890-01325

This tester is needed for checking the cooling system.

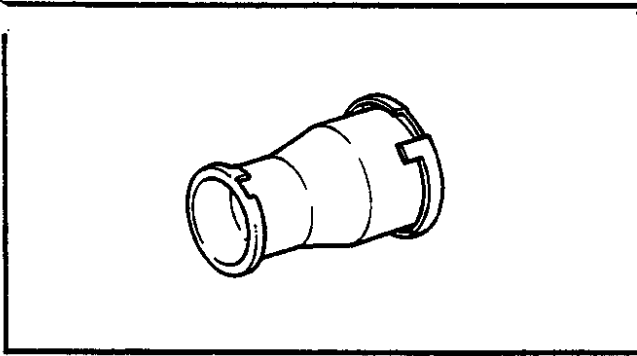

6. Adapter
P/N. 90890-01352

This tool is used for checking the radiator cap.

FOR CHASSIS SERVICE

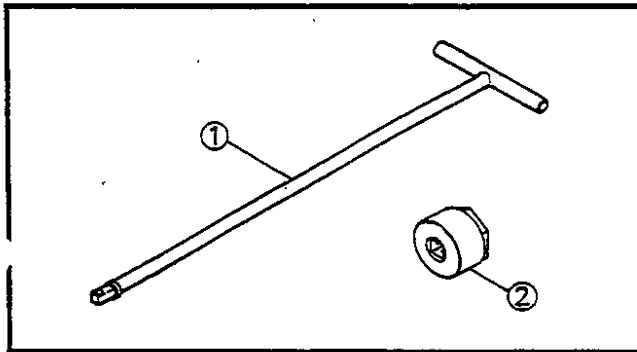

1. T-Handle ①
P/N. 90890-01326
Front Fork Cylinder Holder (M24) ②
P/N. 90890-01328

This tool is used to loosen and tighten the front fork cylinder holding bolt.

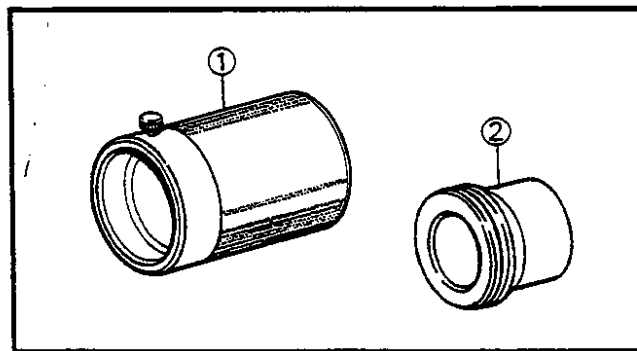

2. Front Fork Seal Driver (Weight) ①
P/N. 90890-01367
Adapter (φ38) ②
P/N. 90890-01372

These tools are used when installing the fork seal.

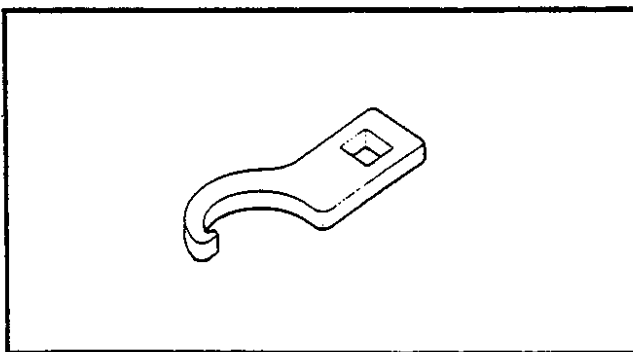

3. Ring Nut Wrench
P/N. 90890-01403

This tool is used to loosen and tighten the steering ring nut.

FOR ELECTRICAL COMPONENTS

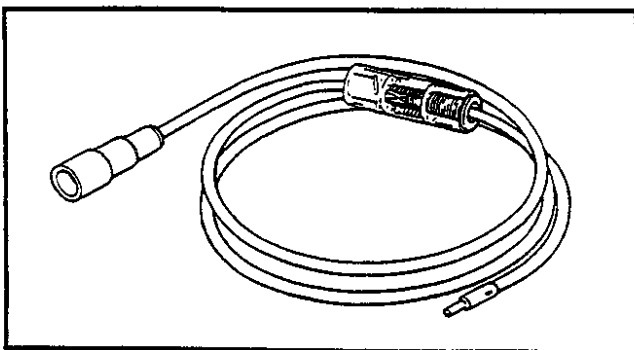

1. Dynamic Spark Tester
P/N. 90890-03144

This tester is necessary for checking the ignition system components.

SPECIAL TOOLS

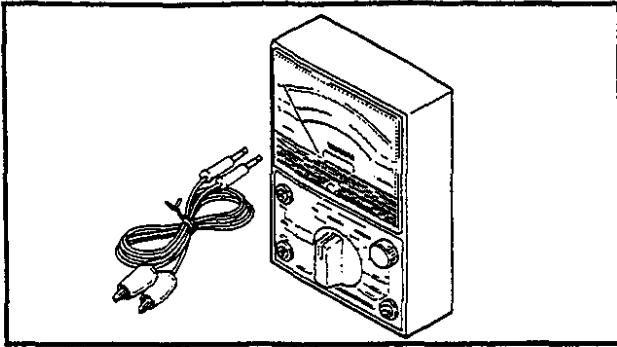

2. Pocket Tester
P/N. 90890-03112

This tester is invaluable for checking the electrical system.

GENERAL SPECIFICATIONS



SPECIFICATIONS

GENERAL SPECIFICATIONS

(GB): For Great Britain (B): For Belgium
(I): For Italy

Model	TDR250	TDR240
Model Code Number:	3CK	3CL
Frame Starting Number:	3CK-000101	3CL-000101
Engine Starting Number:	3CK-000101	3CL-000101
Dimensions:		
Overall Length	2,145 mm (84.4 in) 2,080 mm (81.9 in) (GB, B, I)	2,080 mm (81.9 in)
Overall Width	785 mm (30.9 in)	←
Overall Height	1,215 mm (47.8 in)	←
Seat Height	820 mm (32.3 in)	←
Wheelbase	1,385 mm (54.5 in)	←
Minimum Ground Clearance	230 mm (9.1 in)	←
Basic Weight:		
With Oil and Full Fuel Tank	153 kg (337 lb)	←
Minimum Turning Radius:	2,400 mm (94.5 in)	←
Engine:		
Engine Type	Liquid cooled 2-stroke	←
Induction System	Reed valve	←
Cylinder Arrangement	Forward inclined Parallel 2-cylinder	←
Displacement	249 cm ³	239 cm ³
Bore × Stroke	56.4 × 50.0 mm (2.22 × 1.97 in)	55.2 × 50.0 mm (2.17 × 1.97 in)
Compression Ratio	5.9 : 1	←
Starting System	Kick starter	←
Lubrication System:		
Type	Separate lubrication (Yamaha Autolube)	←
Engine Oil Type	Yamaha oil 2T or air cooled 2-stroke engine oil	←
Transmission Oil Type	SAE 10W30 type SE motor oil	←
Oil Quantity:		
Engine Oil	1.4 L (1.23 Imp qt, 1.48 US qt)	←
Transmission Oil:		
Periodic Oil Change	1.0 L (0.9 Imp qt, 1.1 US qt)	←
Total Amount	1.0 L (0.9 Imp qt, 1.1 US qt)	←

GENERAL SPECIFICATIONS

SPEC



Model	TDR250	TDR240
Coolant Quantity: Including All Routes	1.45 L (1.27 Imp qt, 1.53 US qt)	←
Air Filter: Type	Wet element	←
Fuel: Type	Premium gasoline	←
Fuel Tank Capacity: Full Amount	14 L (3.08 Imp gal, 3.70 US gal)	←
Reserve Amount	4 L (0.88 Imp gal, 1.06 US gal)	←
Carburetor: Type/Quantity Manufacturer	TM28SS/2 pcs. MIKUNI	← ←
Spark Plug: Type/Quantity Manufacturer Plug Gap	BR9ES/2 pcs. NGK 0.7 ~ 0.8 mm (0.028 ~ 0.032 in)	← ← ←
Clutch: Type	Wet, multiple disc	←
Transmission: Type	Constant mesh 6-speed	←
Primary Reduction System	Helical gear	←
Primary Reduction Ratio	56/22 (2.545)	←
Secondary Reduction System	Chain drive	←
Secondary Reduction Ratio	45/14 (3.214)	←
Operation	Left foot operation	←
Gear Ratio:		
1st	36/14 (2.571)	←
2nd	28/16 (1.750)	←
3rd	25/19 (1.316)	←
4th	26/24 (1.083)	←
5th	25/26 (0.962)	←
6th	23/27 (0.852)	←
Chassis: Frame Type	Double cradle	←
Caster Angle	27°	←
Trail	114 mm (4.49 in)	←

GENERAL SPECIFICATIONS

SPEC



Model	TDR250	TDR240
Tire:		
Type	With tube	←
Size:		
Front	100/90-18 56H	←
Rear	120/80-17 61H	←
Wear Limit	1.0 mm (0.04 in)	←
Tire Pressure (Cold Tire):		
Maximum Load*		200 kg (441 lb)
Loading Condition	Front	Rear
Up to 90 kg (198 lb)	180 kPa (1.8 kg/cm ² , 26 psi)	200 kPa (2.0 kg/cm ² , 28 psi)
90 kg (198 lb) ~ Maximum Load*	200 kPa (2.0 kg/cm ² , 28 psi)	230 kPa (2.3 kg/cm ² , 32 psi)
High-speed Riding	200 kPa (2.0 kg/cm ² , 28 psi)	230 kPa (2.3 kg/cm ² , 32 psi)
*Load is the total weight of cargo, rider, passenger, and accessories.		
Brake:		
Front Brake Type	Single disc brake	←
Front Brake Operation	Right hand operation	←
Rear Brake Type	Single disc brake	←
Rear Brake Operation	Right foot operation	←
Suspension:		
Front	Telescopic fork	←
Rear	Swingarm (Link suspension)	←
Shock Absorber:		
Front	Coil spring/ Air-oil damper	←
Rear	Coil spring/ Gas-oil damper	←
Wheel Travel:		
Front Wheel	160 mm (6.3 in)	←
Rear Wheel	150 mm (5.9 in)	←
Electrical:		
Ignition System	CDI	←
Generator System	AC magneto generator	←
Battery:		
Capacity	12V 4AH	←
Type	GM4A-3B	←
Headlight:		
Type	Quartz bulb (Halogen)	←

GENERAL SPECIFICATIONS



Model	TDR250	TDR240
Bulb Wattage (Quantity):		
Headlight	12V 60W/55W (1 pc.)	↑
Auxiliary Light (Except for G.B.)	12V 4W (1 pc.)	↑
Tail/Brake Light	12V 5W/21W (1 pc.)	↑
Flasher Light	12V 21W (4 pcs.)	↑
Meter Light		
Tachometer	12V 1.7W (2 pcs.)	↑
Speedometer	12V 3.4W (1 pc.)	↑
Temperature Gauge	12V 1.7W (1 pc.)	↑
Indicator Light		
"OIL"	12V 3.4W (1 pc.)	↑
"HIGH BEAM"	12V 3.4W (1 pc.)	↑
"NEUTRAL"	12V 3.4W (1 pc.)	↑
"TURN"	12V 3.4W (1 pc.)	↑



MAINTENANCE SPECIFICATIONS

ENGINE

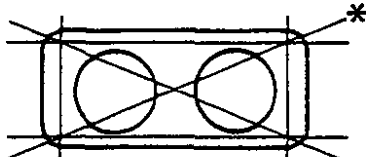
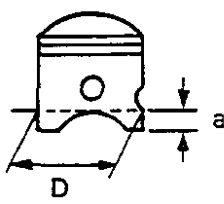
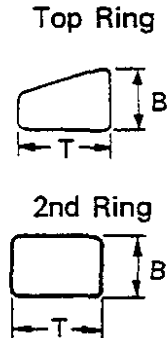
Model	TDR250	TDR240
Cylinder Head: Warpage Limit  *	0.03 mm (0.0012 in) *Lines indicate straightedge measurement.	←
Cylinder: Bore Size Taper Limit Out of Round Limit	56.40 ~ 56.42 mm (2.220 ~ 2.221 in) 0.05 mm (0.002 in) 0.05 mm (0.002 in)	55.20 ~ 55.22 mm (2.173 ~ 2.174 in) ← ←
Piston: Piston Size "D" Measuring Point "a" Piston Off-Set Piston-to-Cylinder Clearance < Limit > Over Size	 56.39 ~ 56.40 mm (2.220 in) 15 mm (0.59 in) 0.5 mm (0.02 in) Exhaust side 0.050 ~ 0.055 mm (0.0020 ~ 0.0021 in) < 0.1 mm (0.004 in) > 56.65 mm (2.23 in) 56.90 mm (2.24 in)	55.19 ~ 55.20 mm (2.173 in) ← Zero mm (Zero in) 0.045 ~ 0.050 mm (0.0018 ~ 0.0020 in) ← 55.45 mm (2.18 in) 55.70 mm (2.19 in)
Piston Ring: Sectional Sketch End Gap (Installed) Side Clearance	 Top Ring Keystone type B = 1.20 mm (0.047 in) T = 2.20 mm (0.087 in) 2nd Ring Plain type B = 1.20 mm (0.047 in) T = 1.85 mm (0.073 in)	← ← ← ← ← ← ← ← ← ←

MAINTENANCE SPECIFICATIONS

SPEC



Model	TDR250	TDR240
Crankshaft: Crank Width "A" Assembly Width "B" Runout Limit "C" Big End Side Clearance "D" < Limit > Small End Free Play "E" < Limit >	55.95 ~ 56.00 mm (2.203 ~ 2.205 in) 167.90 ~ 168.05 mm (6.610 ~ 6.616 in) 0.03 mm (0.0012 in) 0.25 ~ 0.75 mm (0.010 ~ 0.030 in) < 1.0 mm (0.039 in) > 0.4 ~ 0.6 mm (0.016 ~ 0.024 in) < 1.0 mm (0.039 in) >	↑ ↑ ↑ ↑ ↑ ↑ ↑
Clutch: Friction Plate: Thickness Quantity Wear Limit Clutch Plate: Thickness Quantity Warpage Limit Clutch Spring: Free Length Quantity Minimum Free Length Clutch Release Method	2.9 ~ 3.1 mm (0.114 ~ 0.122 in) 7 pcs. 2.8 mm (0.110 in) 1.5 ~ 1.7 mm (0.059 ~ 0.067 in) 6 pcs. 0.1 mm (0.004 in) 34.9 mm (1.374 in) 4 pcs. 32.9 mm (1.295 in) Outer pull (Rack and pinion pull)	↑ ↑ ↑ ↑ ↑ ↑ ↑ ↑
Transmission: Main Axle Runout Limit Drive Axle Runout Limit	0.08 mm (0.003 in) 0.08 mm (0.003 in)	↑ ↑
Shifter: Type Guide Bar Runout Limit	Cam drum and guide bar 0.06 mm (0.002 in)	↑ ↑

MAINTENANCE SPECIFICATIONS

SPEC



Model	TDR250	TDR240
Kick Starter: Type	Ratchet type	←
Air Filter: Oil Type	Yamaha oil 2T or Air-cooled 2 stroke engine oil	←
Carburetor: I.D. Mark	3CK 00	3CL 00
Main Jet (M.J.)	#210	#200
Air Jet (A.J.)	φ1.2	←
Jet Needle - Clip Position (J.N.)	5L19-2/5	5L19-3/5
Needle Jet (N.J.)	P-8 (#505)	←
Cutaway (C.A.)	2.5	←
Pilot Air Jet (P.A.J.)	φ1.2	←
Pilot Outlet (P.O.)	φ0.6	←
Pilot Jet (P.J.)	#20	←
Bypass 1 (B.P.1)	φ1.6	←
Valve Seat Size (V.S.)	φ2.8	←
Starter Jet (G.S.)	#35	←
Power Jet (PW.J.)	#50	#55
Fuel Level (F.L.)	1.5~2.5 mm (0.06~0.10 in)	←
Float Height (F.H.)	15~17 mm (0.59~0.67 in)	←
Idling Speed	1,150~1,250 r/min	←
Reed Valve: Valve Thickness	0.4 mm (0.016 in)	←
Valve Stopper Height	9.4 mm (0.370 in)	←
Valve Bending Limit	1.0 mm (0.04 in)	←
Lubrication System: Autolube Pump: Plunger Diameter	4 mm (0.16 in)	←
Color Code	Pink	←
Minimum Stroke	0.15~0.20 mm (0.006~0.008 in)	←
Maximum Stroke	2.05~2.27 mm (0.081~0.089 in)	←
Minimum Output at 200 Strokes	0.75~1.00 cm ³ (0.02~0.03 Imp oz, 0.02~0.03 US oz)	←
Maximum Output at 200 Strokes	10.3~11.4 cm ³ (0.35~0.36 Imp oz, 0.35~0.36 US oz)	←
Pulley Adjusting Mark	At full throttle	←

MAINTENANCE SPECIFICATIONS





Model	TDR250	TDR240
Oil Pump: Type Tip Clearance < Limit > Side Clearance < Limit >	Trochoid pump 0.10~0.15 mm (0.004~0.006 in) <0.17 mm (0.007 in) > 0.04~0.09 mm (0.002~0.004 in) <0.12 mm (0.005 in) >	← ← ← ← ←
Cooling System: Radiator Core Width Radiator Core Height Radiator Core Thickness Radiator Cap Opening Pressure Reservoir Tank Capacity Water Pump Type Water Pump Reduction Ratio	327.2 mm (12.9 in) 180.0 mm (7.09 in) 16.0 mm (0.63 in) 75~105 kPa (0.75~1.05 kg/cm ² , 10~14 psi) 0.35 L (0.31 Imp qt, 0.37 US qt) Single-suction centrifugal pump 32/20 (1.600)	← ← ← ← ← ← ←
Thermostat: Opening Temperature Full Open Temperature Lift	63~67°C (146~153°F) 80°C (176°F) 7 mm (0.28 in) or more	← ← ←

MAINTENANCE SPECIFICATIONS

SPEC











Tightening Torque:

Part to be tightened	Q'ty	Thread size	Tightening torque			Remarks
			Nm	m•kg	ft•lb	
Cylinder head						
Cap nut	4	M8 × 1.25	22	2.2	16	
Flange nut	6	M8 × 1.25	22	2.2	16	
Spark plug	2	M14 × 1.25	20	2.0	14	
Cylinder						
Stud bolt	4	M8 × 1.25	13	1.3	9.4	
Stud bolt	6	M8 × 1.25	13	1.3	9.4	
Flange nut	8	M8 × 1.25	28	2.8	20	
Crankcase						
Stud bolt	4	M8 × 1.25	13	1.3	9.4	
Stud bolt	4	M8 × 1.25	13	1.3	9.4	
Flange bolt	7	M8 × 1.25	24	2.4	17	L: 90 mm (3.5 in)
Flange bolt	1	M8 × 1.25	24	2.4	17	L: 105 mm (4.1 in)
Flange bolt	7	M6 × 1.0	10	1.0	7.2	L: 55 mm (2.2 in)
Flange bolt	1	M6 × 1.0	10	1.0	7.2	L: 40 mm (1.6 in)
Pulley cover (Power valve)						
Hexagon socket head bolt	2	M5 × 0.8	7	0.7	5.1	
Pulley housing (Power valve)						
Hexagon socket head bolt	2	M5 × 0.8	7	0.7	5.1	
Power valve						
Hexagon socket head bolt	2	M5 × 0.8	7	0.7	5.1	
Power valve pulley						
Hexagon bolt with spring washer and plain washer	1	M6 × 1.0	10	1.0	7.2	
Thrust plate (Power valve)						
Hexagon socket head bolt	2	M5 × 0.8	7	0.7	5.1	
Power valve holder						
Hexagon socket head bolt	1	M5 × 0.8	7	0.7	5.1	
Power valve joint						
Hexagon socket head bolt	2	M5 × 0.8	7	0.7	5.1	
Power valve cable adjuster						
Hexagon nut	2	M6 × 1.0	8	0.8	5.8	
Water pump housing cover						
Hexagon socket head bolt	2	M6 × 1.0	10	1.0	7.2	L: 25 mm (1.0 in)
Hexagon socket head bolt	2	M6 × 1.0	10	1.0	7.2	L: 65 mm (2.5 in)
Drain bolt	1	M8 × 1.25	16	1.6	11	
Thermostatic valve cover						
Hexagon socket head bolt	3	M6 × 1.0	10	1.0	7.2	
Radiator						
Flange bolt	2	M6 × 1.0	6	0.6	4.3	
Radiator cover						
Panhead screw with spring washer and plain washer	4	M6 × 1.0	6	0.6	4.3	
Autolube pump						
Panhead screw	2	M5 × 0.8	5	0.5	3.6	

MAINTENANCE SPECIFICATIONS

SPEC



Part to be tightened	Q'ty	Thread size	Tightening torque			Remarks
			Nm	m•kg	ft•lb	
Oil pump						
Panhead screw	3	M5 × 0.8	5	0.5	3.6	
Delivery pipe (Oil pump)						
Panhead screw	1	M5 × 0.8	5	0.5	3.6	
Strainer cover						
Panhead screw	2	M5 × 0.8	5	0.5	3.6	
Intake manifold						
Hexagon socket head bolt	8	M6 × 1.0	10	1.0	7.2	
Starter lever						
Panhead screw with spring washer	2	M4 × 0.7	2	0.2	1.4	
Muffler						
Flange nut	4	M8 × 1.25	18	1.8	13	
A.C. Generator cover						
Hexagon socket head bolt	4	M6 × 1.0	5	0.5	3.6	
Crankcase cover (Left)						
Hexagon socket head bolt	3	M6 × 1.0	5	0.5	3.6	
Crankcase cover (Right)						
Hexagon socket head bolt	7	M6 × 1.0	10	1.0	7.2	
Flange bolt	1	M10 × 1.0	22	2.2	16	
Drain bolt	1	M8 × 1.25	16	1.6	11	
Autolube pump cover						
Hexagon socket head bolt	2	M6 × 1.0	6	0.6	4.3	
Clutch cable holder						
Hexagon socket head bolt	1	M6 × 1.0	10	1.0	7.2	
Kick crank						
Hexagon bolt	1	M8 × 1.25	25	2.5	18	
Primary drive gear						
Hexagon nut	1	M16 × 1.0	65	6.5	47	
Clutch boss						
Hexagon nut	1	M20 × 1.0	90	9.0	65	
Pressure plate						
Hexagon screw with plain washer	4	M5 × 0.8	7	0.7	5.1	
Pull lever holder						
Panhead screw	1	M6 × 1.0	10	1.0	7.2	
Bearing holder (Main axle)						
Hexagon socket head bolt	2	M6 × 1.0	10	1.0	7.2	
Drive sprocket						
Hexagon nut	1	M20 × 1.0	90	9.0	65	
Stopper plate (Shift cam)						
Flat head screw	2	M6 × 1.0	8	0.8	5.8	
Stopper lever						
Bolt	1	M6 × 1.0	10	1.0	7.2	
Shift lever adjuster						
Hexagon nut	1	M8 × 1.25	30	3.0	22	

MAINTENANCE SPECIFICATIONS

SPEC



Part to be tightened	Q'ty	Thread size	Tightening torque			Remarks
			Nm	m•kg	ft•lb	
Stator coil Panhead screw with spring washer	3	M6 × 1.0	7	0.7	5.1	
Pickup coil Panhead screw with spring washer and plain washer	2	M5 × 0.8	5	0.5	3.6	
CDI magneto Hexagon nut	1	M12 × 1.25	80	8.0	58	
Neutral switch	1	M10 × 1.25	3	0.3	2.2	
Thermo unit	1	PT 1/8	15	1.5	11	

Tightening sequence:

Crankcase upper

Crankcase lower

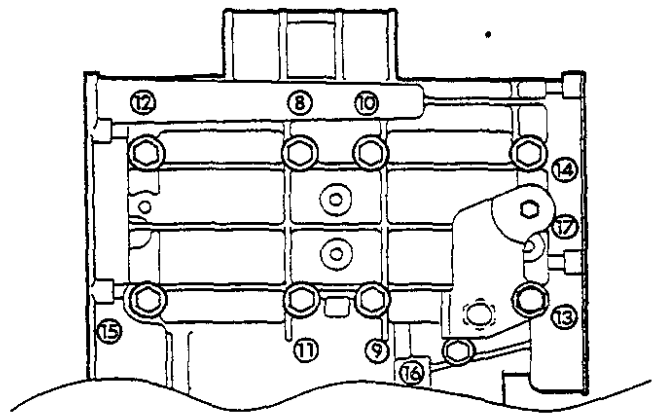
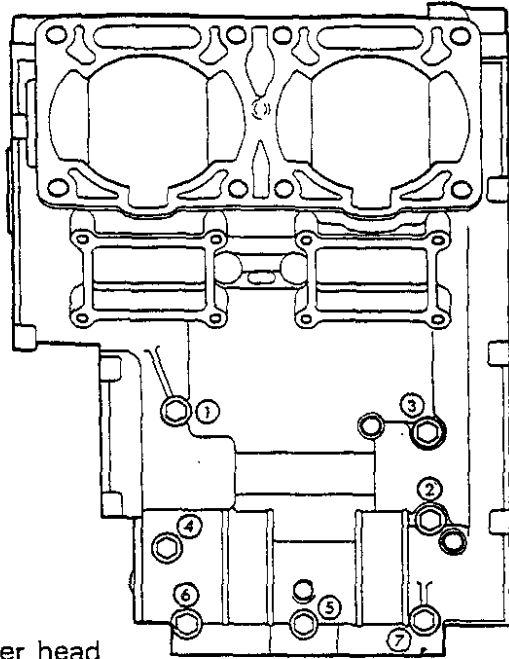

Cylinder head

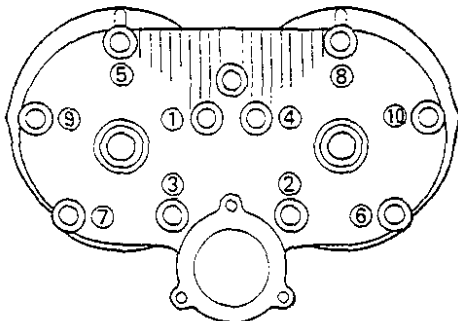

MAINTENANCE SPECIFICATIONS

SPEC



CHASSIS

Model	TDR250	TDR240
Steering System:		
Bearing Type		
Upper	Ball bearing	←
Lower	Taper roller bearing	←
Ball Bearing Size (Quantity)	3/16 in (22 pcs.)	←
Lock-to-Lock Angle:		
Left	40°	←
Right	40°	←
Front Suspension:		
Front Fork Travel	160 mm (6.3 in)	←
Fork Spring Free Length	513.5 mm (20.2 in)	←
< Limit >	< 508 mm (20.0 in) >	←
Spring Rate (K ₁)	6.5 N/mm (0.65 kg/mm, 35.8 lb/in)	←
(K ₂)	13.0 N/mm (1.30 kg/mm, 71.6 lb/in)	←
Stroke (K ₁)	0.0 ~ 95.0 mm (0.0 ~ 3.74 in)	←
(K ₂)	95.0 ~ 160.0 mm (3.74 ~ 6.30 in)	←
Optional Spring	No.	
Oil Capacity	394 cm ³ (13.87 Imp oz, 13.32 US oz)	←
Oil Level*	115 mm (4.53 in)	←
*From top of inner tube fully compressed without spring.		
Oil Grade	Fork oil 10W or equivalent	←
Enclosed Air Pressure		
Standard	Zero kPa (Zero kg/cm ² , Zero psi)	←
Maximum	40 kPa (0.4 kg/cm ² , 5.7 psi)	←
Rear Suspension:		
Shock Absorber Travel	55 mm (2.16 in)	←
Spring Free Length	190 mm (7.48 in)	←
Fitting Length	180 mm (7.08 in)	←
Spring Rate (K ₁)	115 N/mm (11.5 kg/mm, 633 lb/in)	←
Stroke (K ₁)	0.0 ~ 55.0 mm (0.0 ~ 2.16 in)	←
Optional Spring	No.	←

MAINTENANCE SPECIFICATIONS

SPEC



Model	TDR250	TDR240
Swingarm: Free Play Limit (Swingarm End)* *Move Swingarm End Side to Side.	3.0 mm (0.12 in)	←
Front Wheel: Type Rim Size Rim Material Rim Run Out Limit Vertical Lateral	Spoke wheel 2.15-18 Aluminum 2.0 mm (0.08 in) 2.0 mm (0.08 in)	← ← ← ← ←
Rear Wheel: Type Rim Size Rim Material Rim Run Out Limit Vertical Lateral	Spoke wheel 2.50-17 Aluminum 2.0 mm (0.08 in) 2.0 mm (0.08 in)	← ← ← ← ←
Drive Chain: Type/Manufacturer Number of Links Chain Free Play 10-Links Length Limit	520V2/DAIDO 108 Links 20~30 mm (0.8~1.2 in) 150.1 mm (5.91 in)	← ← ← ←
Front Disc Brake: Type Disc Outside Diameter Disc Thickness Pad Thickness <Wear Limit> Master Cylinder Inside Diameter Caliper Cylinder Inside Diameter Brake Fluid Type	Single 320 mm (12.60 in) 5 mm (0.20 in) 7.5 mm (0.30 in) <0.5 mm (0.02 in)> 14.0 mm (0.55 in) 32.1 mm (1.26 in) DOT #4 (If DOT #4 is not available #3 can be used.)	↑ ↑ ↑ ↑ ↑ ↑ ↑
Rear Disc Brake: Type Disc Outside Diameter Disc Thickness Pad Thickness <Wear Limit> Master Cylinder Inside Diameter Caliper Cylinder Inside Diameter Brake Fluid Type	Single 210 mm (8.27 in) 5 mm (0.20 in) 5.5 mm (0.21 in) <0.5 mm (0.02 in)> 14.0 mm (0.55 in) 38.1 mm (1.50 in) DOT #4 (If DOT #4 is not available #3 can be used.)	↑ ↑ ↑ ↑ ↑ ↑ ↑

MAINTENANCE SPECIFICATIONS





Model	TDR250	TDR240
Brake Lever and Brake Pedal: Brake Lever Free Play* *At end of brake lever Brake Pedal Position* *Below top of footrest	2~5 mm (0.08~0.20 in) 15 mm (0.20 in)	← ←
Clutch Lever and Throttle Grip: Clutch Lever Free Play *At end of clutch lever Throttle Cable Free Play* *At grip flange	10~15 mm (0.39~0.59 in) 2~5 mm (0.08~0.20 in)	← ←

MAINTENANCE SPECIFICATIONS

SPEC





Tightening Torque:

Part to be tightened	Thread size	Tightening torque			Remarks
		Nm	m•kg	ft•lb	
Torque rod stay and engine bracket	M10 × 1.25	45	4.5	32	
Torque rod and torque rod stay	M10 × 1.25	45	4.5	32	
Torque rod and frame	M10 × 1.25	45	4.5	32	
Engine mount					
Front	M10 × 1.25	55	5.5	40	
Rear	M10 × 1.25	55	5.5	40	
Engine stay and frame	M8 × 1.25	25	2.5	18	
Cowling stay and frame	M8 × 1.25	20	2.0	14	
Pivot shaft	M16 × 1.5	100	10.0	72	
Connecting arm and swingarm	M12 × 1.25	50	5.0	36	
Connecting arm and relay arm	M12 × 1.25	50	5.0	36	
Relay arm and frame	M10 × 1.25	40	4.0	29	
Relay arm and rear shock absorber	M10 × 1.25	40	4.0	29	
Ring nut (Steering shaft)	M25 × 1.0	11	1.1	8.0	See "NOTE"
Steering shaft and handlebar crown	M14 × 1.25	70	7.0	50	
Handlebar crown and inner tube	M8 × 1.25	25	2.5	18	
Handlebar and Handlebar holder	M8 × 1.25	15	1.5	11	
Union screw (Oil tank)	M18 × 1.5	6	0.6	4.3	
Mud guard and box	M5 × 0.8	1	0.1	0.7	
Nipple and spoke	B•C 3.5	2	0.2	1.4	
Brake disc and front wheel hub	M8 × 1.25	20	2.0	14	
Front wheel axle	M14 × 1.5	60	6.0	43	
Brake caliper and front fork	M10 × 1.25	35	3.5	25	
Brake disc and rear wheel hub	M8 × 1.25	20	2.0	14	
Damper clutch and driven sprocket	M8 × 1.25	37	3.7	27	
Brake caliper and caliper bracket	M10 × 1.25	35	3.5	25	
Caliper bracket and swingarm	M10 × 1.25	45	4.5	32	
Rear wheel axle	M14 × 1.5	100	10.0	72	
Locknut (Rear wheel axle)	M14 × 1.5	45	4.5	32	
Master cylinder (Front brake) and master cylinder bracket	M6 × 1.0	8	0.8	5.8	
Union bolt (Brake hose and brake caliper)	M10 × 1.25	26	2.6	19	
Union bolt (Brake hose and master cylinder)	M10 × 1.25	26	2.6	19	
Side stand and frame					
Bolt	M10 × 1.25	35	3.5	25	
Locknut	M10 × 1.25	35	3.5	25	
Footrest bracket (Rear) and frame	M8 × 1.25	25	2.5	18	
Master cylinder (Rear brake) and frame	M8 × 1.25	20	2.0	14	

MAINTENANCE SPECIFICATIONS

SPEC



Part to be tightened	Thread size	Tightening torque			Remarks
		Nm	m•kg	ft•lb	
Union bolt (Brake hose and master cylinder)	M10×1.25	26	2.6	19	
Union bolt (Brake hose and brake caliper)	M10×1.25	26	2.6	19	
Brake pedal	M10×1.25	45	4.5	32	
Shift pedal and frame	M8 ×1.25	20	2.0	14	
Locknut (Shift rod)	M6 ×1.0	8	0.8	5.8	
Shift arm and shift shaft	M6 ×1.0	14	1.4	10	
Wind screen	M5 ×0.8	0.6	0.06	0.43	
Cowling stay and steering head	M6 ×1.0	8	0.8	5.8	
Cowling stay and frame	M6 ×1.0	8	0.8	5.8	
Lower bracket and inner tube	M8 ×1.25	23	2.3	17	
Cap bolt (Front fork)	M34×1.0	23	2.3	17	
Pinch bolt (Front fork)	M8 ×1.25	20	2.0	14	
Inner tube and damper rod	M10×1.25	30	3.0	22	
Drain screw (Front fork oil)	M6 ×1.0	2	0.2	1.4	
Locknut (Spring adjuster of rear shock absorber)	M20×1.0	55	5.5	40	

NOTE:

1. First, tighten the ring nut approximately 38 Nm (3.8 m•kg, 27 ft•lb) by using the torque wrench, then loosen the ring nut one turn.
2. Retighten the ring nut to specification.

MAINTENANCE SPECIFICATIONS

SPEC



ELECTRICAL

Model	TDR250	TDR240
Voltage:	12V	←
Ignition System: Ignition Timing (B.T.D.C.) Advancer Type	19° at 1,200 r/min Electrical type	← ←
CDI:		
Magneto Model/Manufacturer	VCI08/N.D.	←
CDI Unit Model/Manufacturer	QCA03/N.D.	←
Pickup Coil Resistance (Color)	188 ~ 282Ω at 20°C (68°F) (White/Black— White/Green)	←
Source Coil Resistance (Color)	129 ~ 193Ω at 20°C (68°F) (Green—Brown) 3.6 ~ 5.4Ω at 20°C (68°F) (Red—Brown)	← ←
Ignition Coil:		
Model/Manufacturer	JO228/N.D.	←
Minimum Spark Gap	6 mm (0.24 in)	←
Primary Coil Resistance	0.28 ~ 0.38Ω at 20°C (68°F)	←
Secondary Coil Resistance	4.7 ~ 7.0kΩ at 20°C (68°F)	←
Spark Plug Cap:		
Type	Resin type	←
Resistance	4 ~ 6kΩ at 20°C (68°F)	←

MAINTENANCE SPECIFICATIONS

SPEC



Model	TDR250	TDR240
Charging System: Type	AC magneto generator	←
A.C. Magneto Generator: Model/Manufacturer	VCI08/N.D.	←
Charging Current (Day)	7A or more at 2,000 r/min	←
	12A or more at 5,000 r/min	←
Charging Coil Resistance (Color)	0.44 ~ 0.66Ω at 20°C (68°F) (White—White)	←
Charging Voltage	14.3 ~ 15.3V at 3,000 r/min	←
Rectifier/Regulator: Model/Manufacturer	SH569/SHINDENGEN	←
Rectifier Capacity	25A	←
Withstand Voltage	240V	←
Voltage Regulator Type	Semi conductor short circuit type	←
No Load Regulated Voltage	14.3 ~ 15.3V	←
Battery: Specific Gravity	1.280	←
Horn: Type	Plane type	←
Quantity	1 pc.	←
Model/Manufacturer	YF-12/NIKKO	←
Maximum Amperage	2.5A	←
Flasher Relay: Type	Condenser Type	←
Model/Manufacturer	FZ249SD/N.D.	←
Self Cancelling Device	No.	←
Flasher Frequency	75 ~ 95 cycles/min	←
Wattage	21W × 2 + 3.4W	←
Oil Level Switch: Model/Manufacturer	312/N.D.	←
Circuit Breaker: Type	Non fuse breaker	←
Capacity	20A	←
Thermo Unit: Model/Manufacturer	2YK/NIPPON SEIKI	←



GENERAL TORQUE SPECIFICATIONS

This chart specifies torque for standard fasteners with standard I.S.O. pitch threads. Torque specifications for special components or assemblies are included in the applicable sections of this book. To avoid warpage, tighten multi-fastener assemblies in a crisscross fashion, in progressive stages, until full torque is reached. Unless otherwise specified, torque specifications call for clean, dry threads. Components should be at room temperature.

A (Nut)	B (Bolt)	General torque specifications		
		Nm	m·kg	ft·lb
10 mm	6 mm	6	0.6	4.3
12 mm	8 mm	15	1.5	11
14 mm	10 mm	30	3.0	22
17 mm	12 mm	55	5.5	40
19 mm	14 mm	85	8.5	61
22 mm	16 mm	130	13.0	94

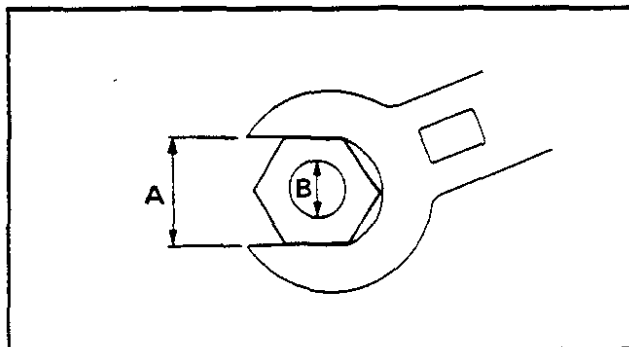

A: Distance across flats
B: Outside thread diameter

DEFINITION OF UNITS

Unit	Read	Definition	Measure
mm	millimeter	10^{-3} meter	Length
cm	centimeter	10^{-2} meter	Length
kg	kilogram	10^3 gram	Weight
N	Newton	$1 \text{ kg} \times \text{m}/\text{sec}^2$	Force
Nm	Newton meter	$\text{N} \times \text{m}$	Torque
m·kg	Meter kilogram	$\text{m} \times \text{kg}$	Torque
Pa	Pascal	N/m^2	Pressure
N/mm	Newton per millimeter	N/mm	Spring rate
L	Liter	—	Volume or capacity
cm^3	Cubic centimeter	—	Volume or capacity
r/min	Rotation per minute	—	Engine speed

LUBRICATION POINTS AND LUBRICANT TYPE



LUBRICATION POINTS AND LUBRICANT TYPE ENGINE

Lubrication Points (Part name)	Lubricant Type
Oil seal lips (All)	
O-rings (All)	
Bearing retainer Crankshaft bearings (Left and center) Needle bearings (Connecting rod) Main axle bearings Drive axle bearings Shift cam bearings Pull rod bearing	
Crank pins	
Piston rings, piston pins and pistons	
Power valve holders	
Impeller shaft (Water pump)	
Warm shaft (Autolube pump)	
Pump shaft (Oil pump)	
Kick idle gear	
Kick axle	
Primary driven gear (Clutch housing)	
Pull rod	
Pull lever axle	
Sliding gear (Transmission)	
Free movement gear (Transmission)	
Collar (Drive axle)	
Guide bar (Shift forks)	
Link ball (Change pedal)	
Pivoting points (Change pedal)	
Crankcase mating surfaces	Yamaha bond No. 4

LUBRICATION POINTS AND LUBRICANT TYPE

SPEC



CHASSIS

Lubrication Points (Part name)	Lubricant Type
Ball bearings (Steering shaft)	
Oil seal lips (Front wheel and rear wheel)	
Pivoting point (Brake pedal)	
Pivoting point (Sidestand)	
Right handlebar end	
Throttle cable end (Throttle grip)	
Pivoting point (Clutch lever)	
Clutch cable end (Clutch lever)	
Pivoting point (Brake lever)	
Bushes (Rear shock absorber)	
Oil seal lips (Rear shock absorber)	
Pivot shaft (Swingarm)	
Oil seal lips (Swingarm)	
Bearing (Swingarm)	
Bushes (Relay arm)	
Collars (Relay arm)	
Oil seal lips (Relay arm)	
Oil seal lips (Connecting arm)	
Collars (Connecting arm)	
Front wheel axle	
Rear wheel axle	
Collar (Front wheel)	
Speedometer gear unit	
Pivoting point (Footrest)	



LUBRICATION DIAGRAM

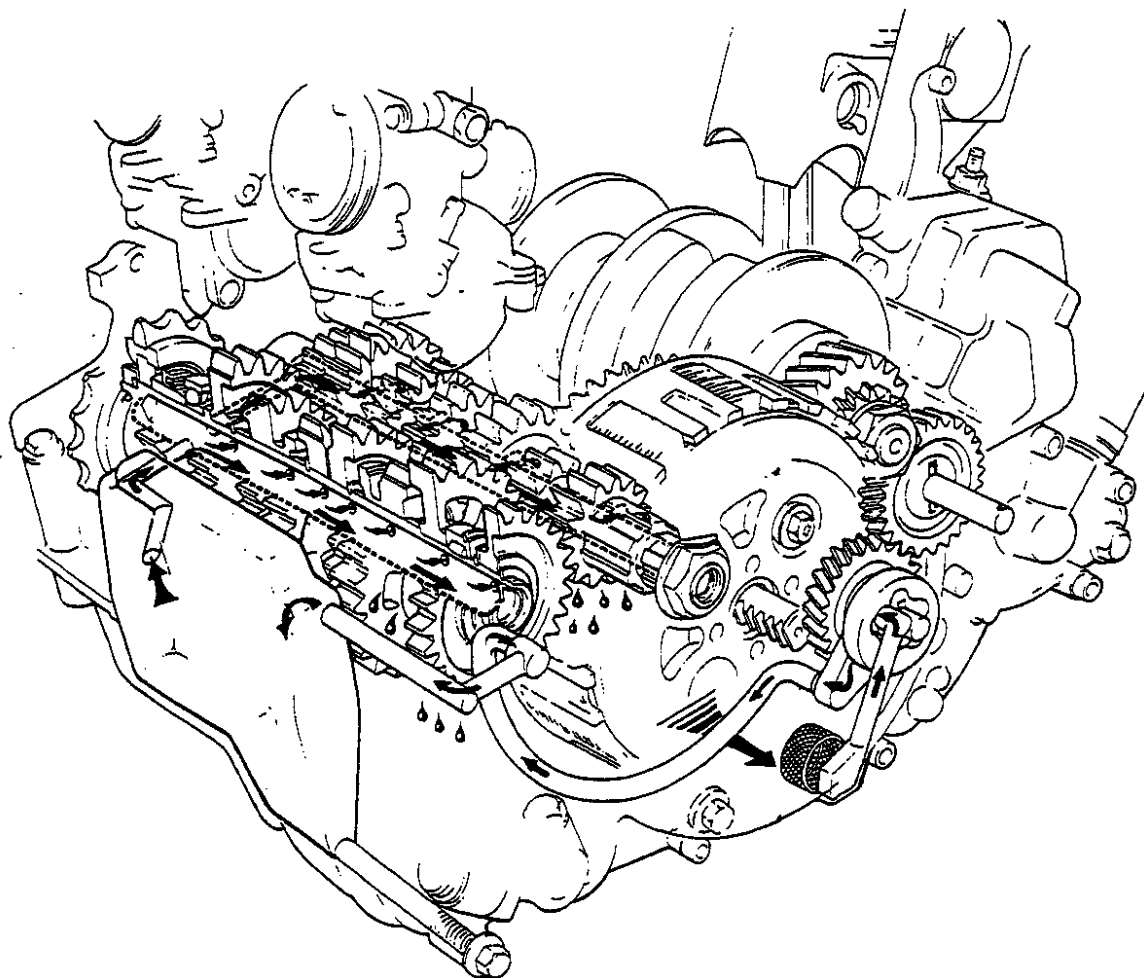

⇒ Pressured feed
--- Splashed

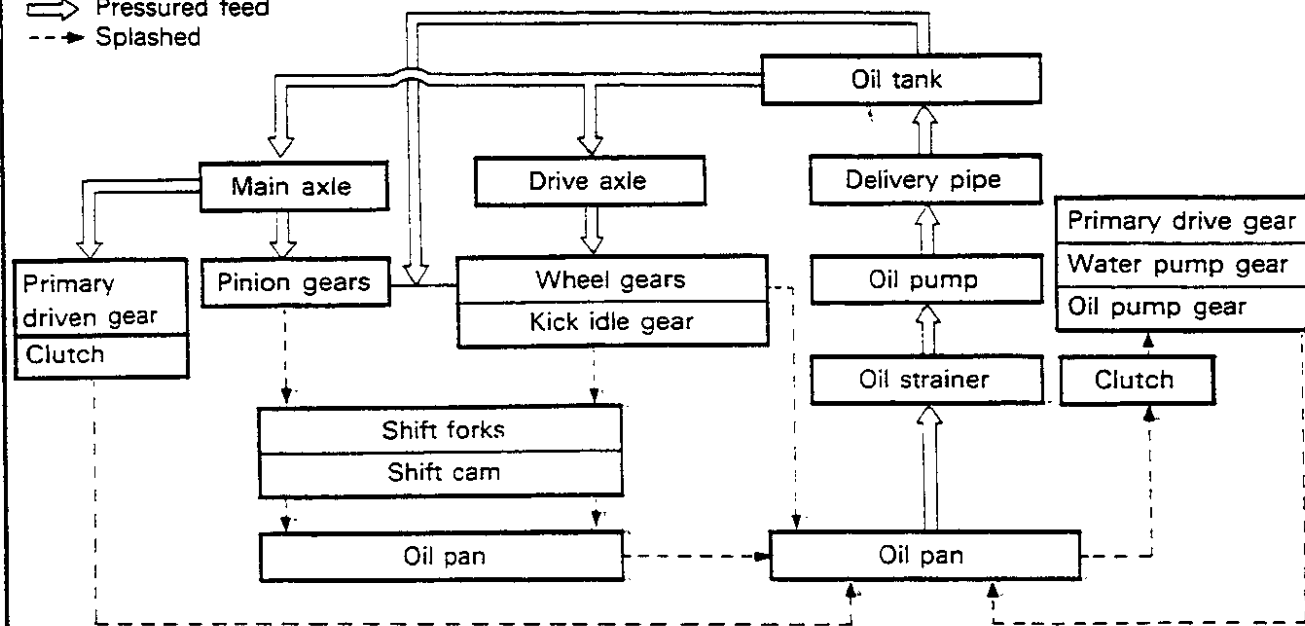



COOLANT FLOW CHART

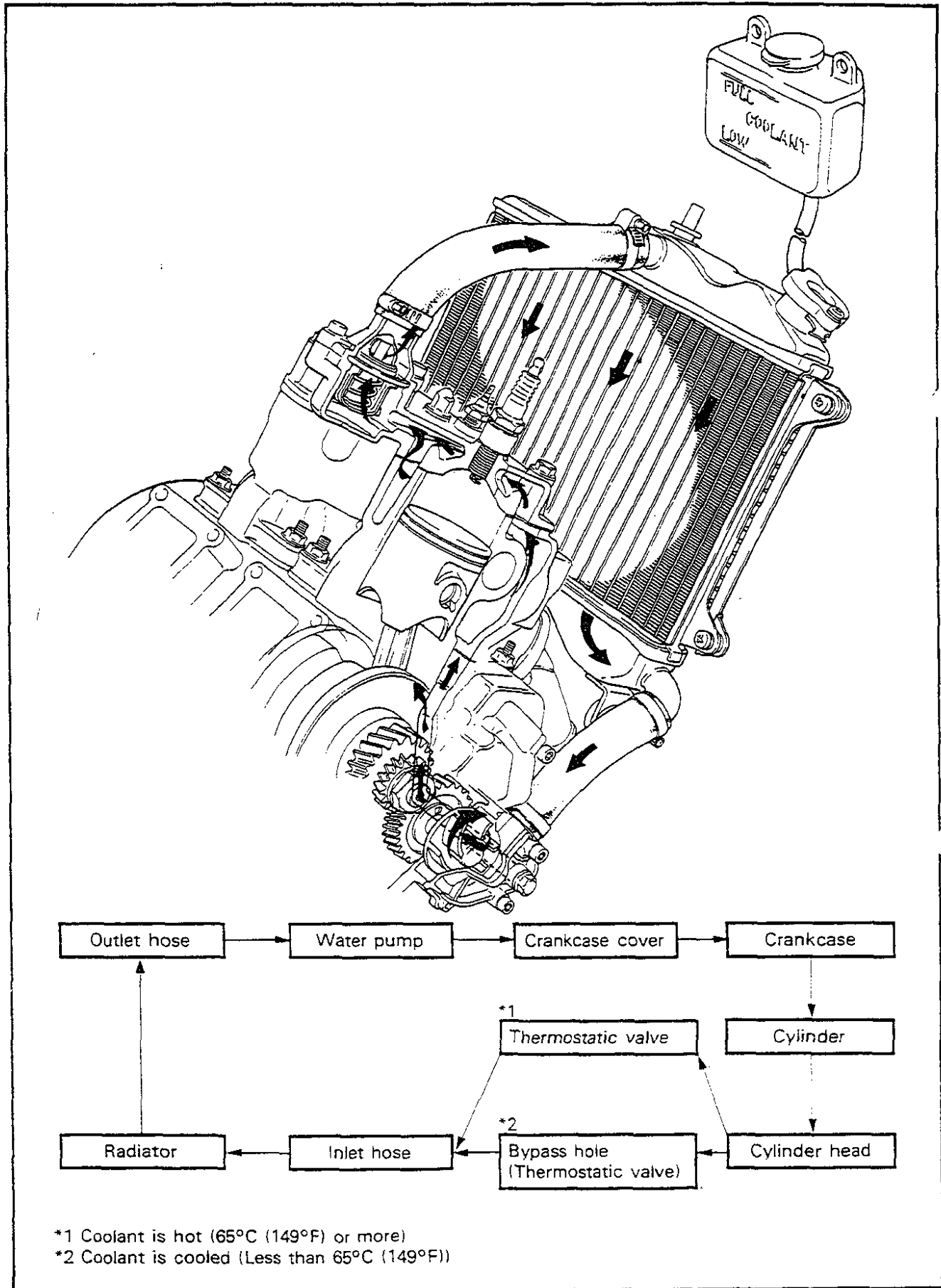

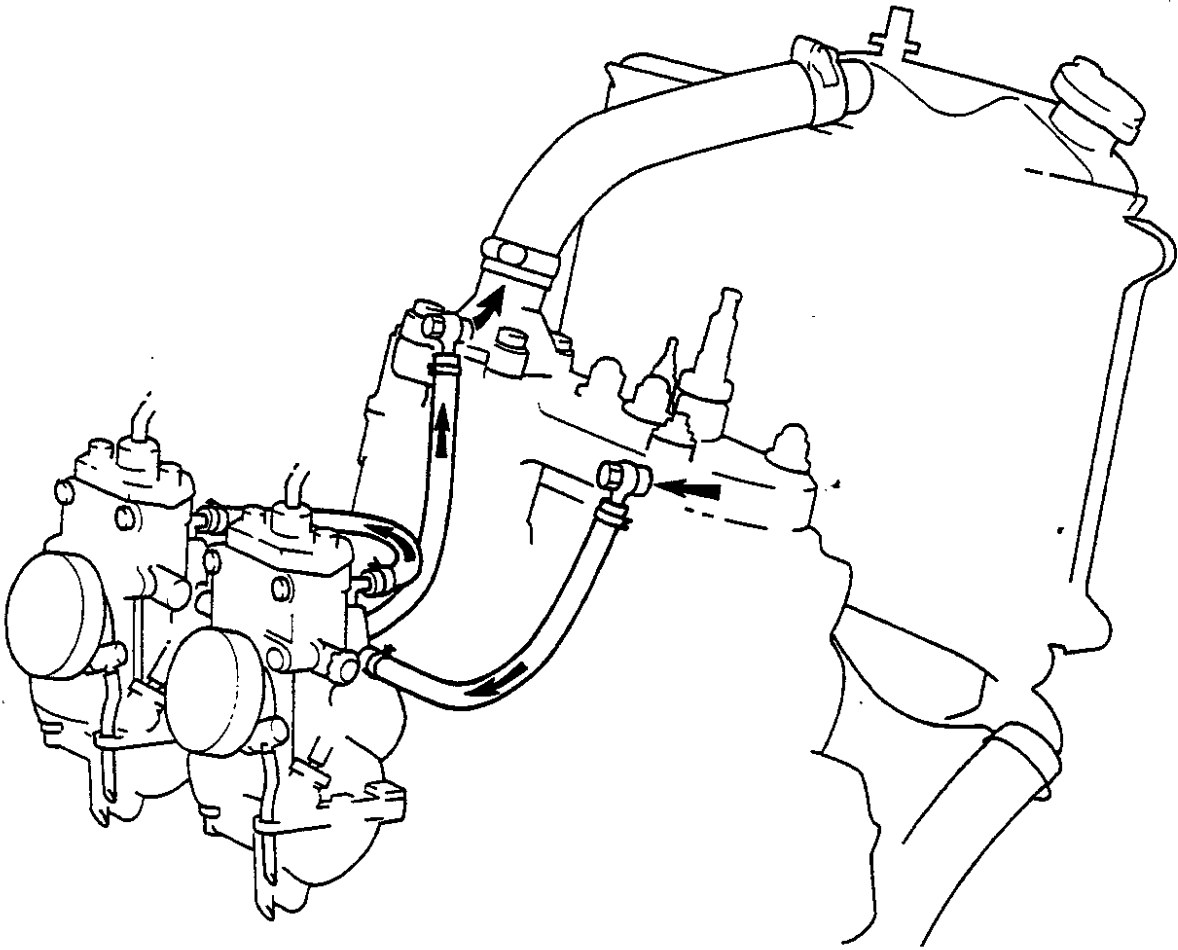

WARM WATER CIRCULATION WAY

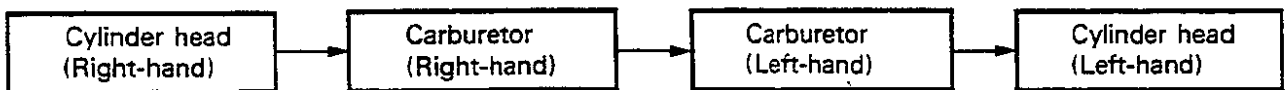



CABLE ROUTING

- ① Throttle cable
- ② Clutch cable
- ③ Handlebar switch lead
- ④ Brake switch lead
- ⑤ Handlebar switch lead
- ⑥ Clamp
- ⑦ Flasher light lead
- ⑧ Band
- ⑨ Speedometer cable

A Hold temperature gauge leads, headlight leads and indicator light leads with clamp.

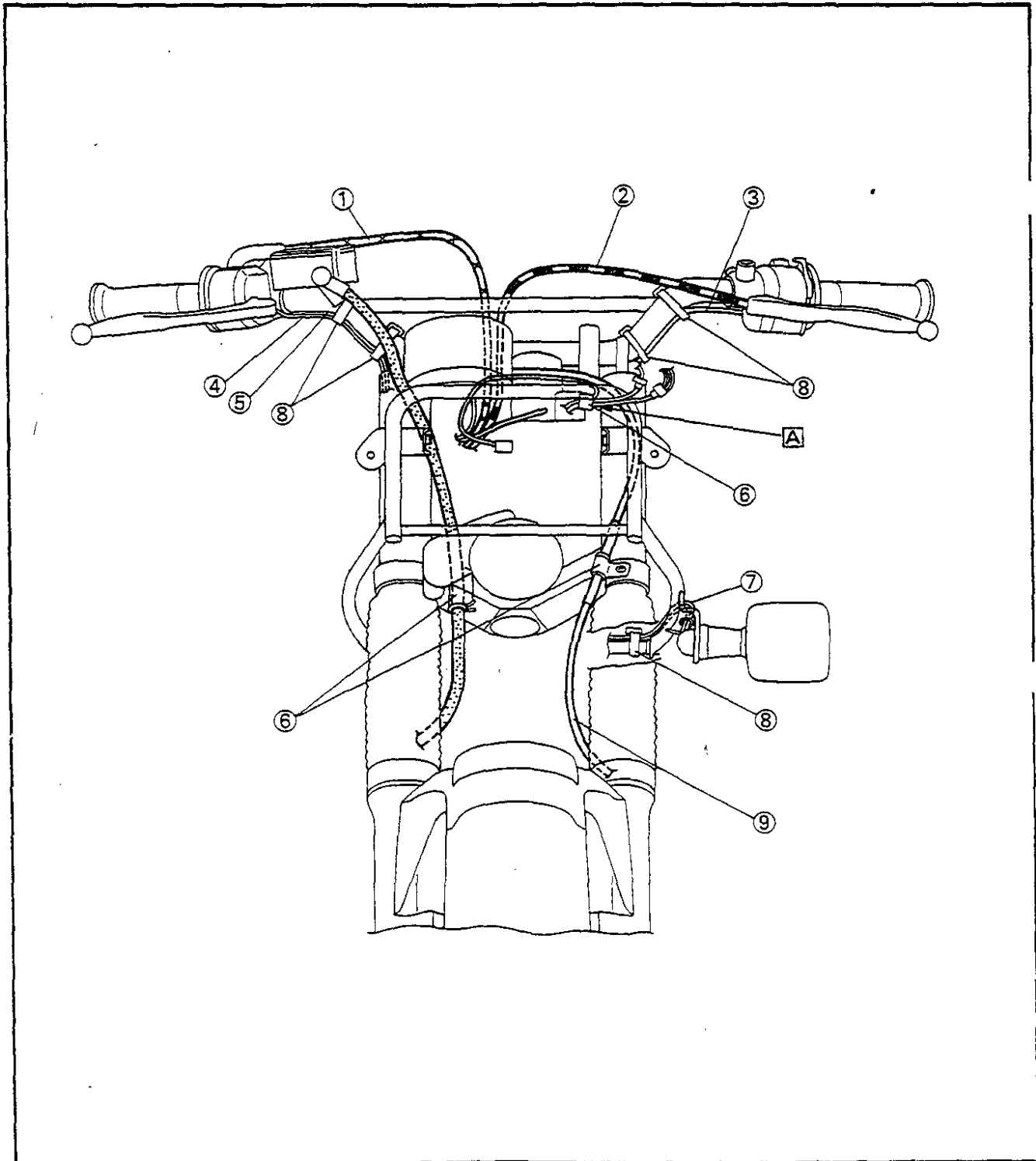

CABLE ROUTING

SPEC



- ① Clutch cable
- ② Throttle cable
- ③ Brake switch lead
- ④ Handlebar switch lead (Right)
- ⑤ To flasher light (Right)
- ⑥ To rectifier/regulator
- ⑦ Flasher relay
- ⑧ To flasher light (Left)
- ⑨ To handlebar switch (Left)
- ⑩ To CDI unit
- ⑪ To CDI magneto
- ⑫ Clamp
- ⑬ Flasher light lead
- A Pass clutch cable and throttle cable between speedometer and handlebar crown.
- B Pass wireharness under seat rail.
- C Pass flasher light lead through grommet.
- D Pass wireharness under pipe.

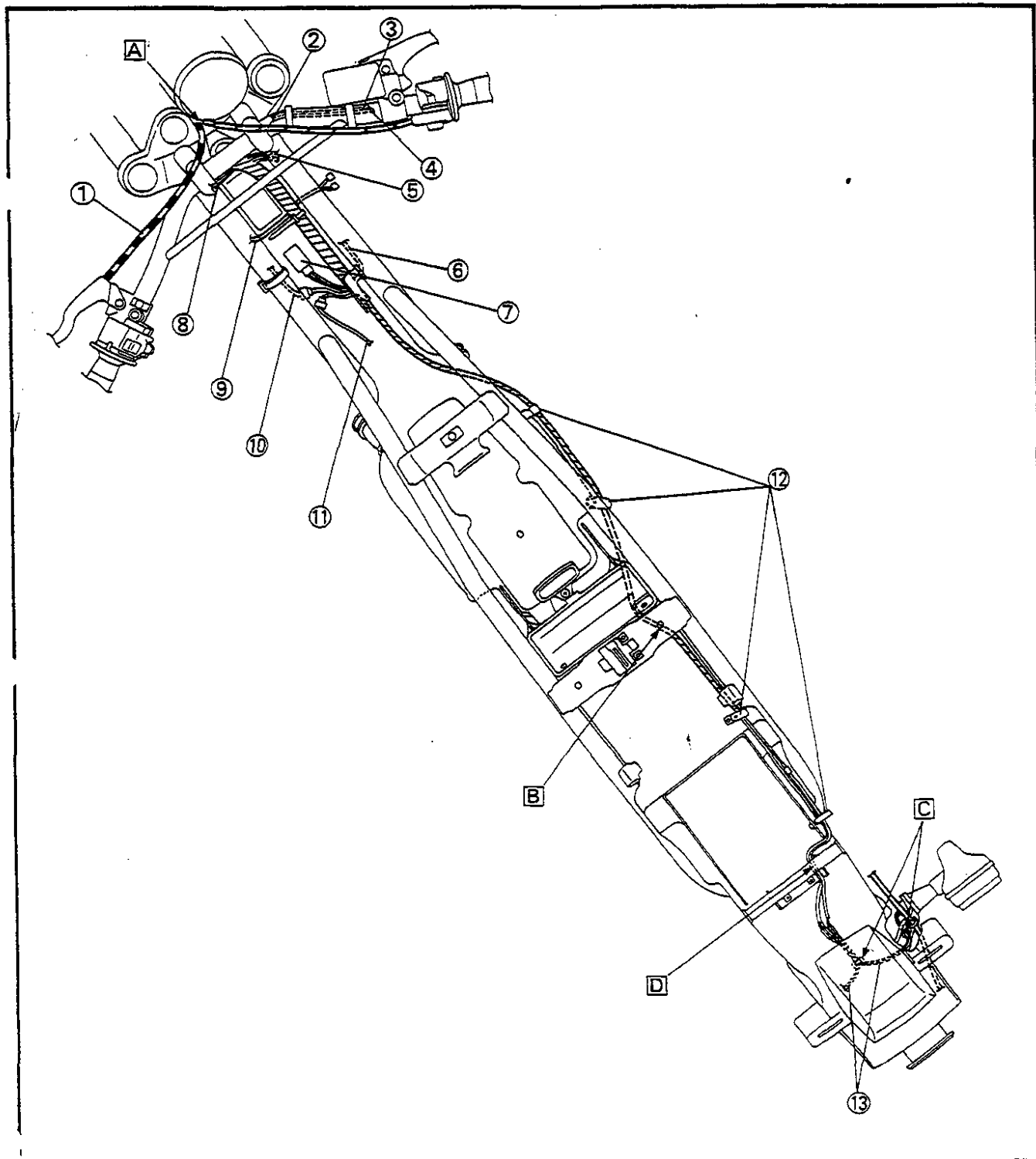

CABLE ROUTING

SPEC



- | | | |
|------------------------------|-----------------------------|------------------------------|
| ① Speedometer cable | ⑨ Servomotor | ⑰ CDI magneto lead |
| ② Horn | ⑩ Oil level gauge lead | ⑱ Overflow hose (Carburetor) |
| ③ Horn lead | ⑪ Overflow hose (Fuel tank) | ⑲ Starter cable |
| ④ Temperature gauge lead | ⑫ Throttle cable | ⑳ Fuel hose |
| ⑤ Indicator light lead | ⑬ Oil hose | ㉑ Vacuum hose |
| ⑥ Diode unit | ⑭ CDI magneto lead | ㉒ Ignition coil |
| ⑦ Handlebar switch lead | ⑮ Reservoir hose | ㉓ Flasher light lead |
| ⑧ CDI unit/YPVS control unit | ⑯ Side stand switch | |

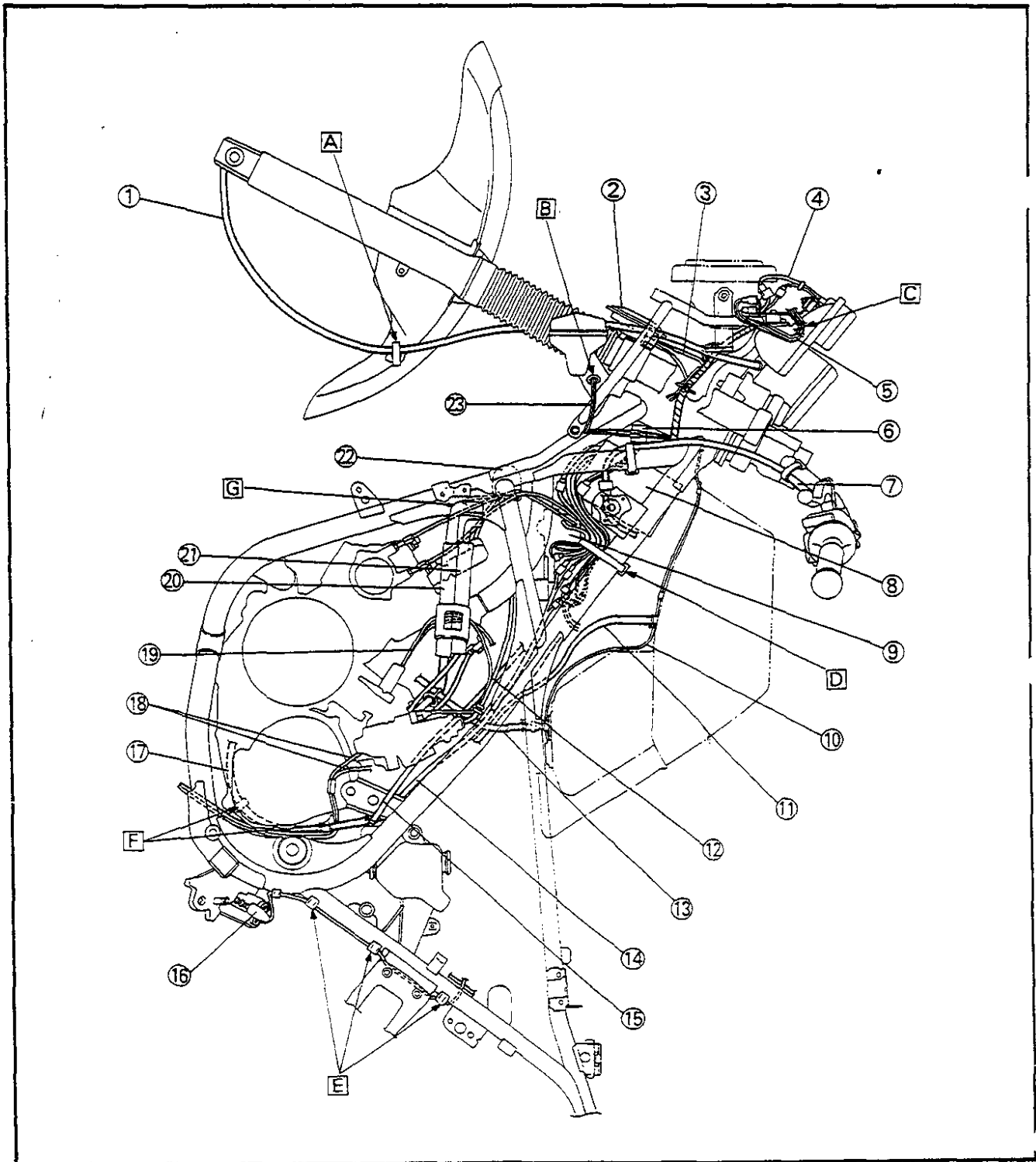



- A** Pass speedometer cable through cable guide.
- B** Pass flasher light leads through grommet.
- C** Hold indicator light leads with clamp.
- D** Hold CDI magneto leads and servomotor leads with band.
- E** Hold sidestand switch lead with clamp.
- F** Hold CDI magneto leads with clamp.
- G** Pass the spark plug leads inside of YPVS cables.

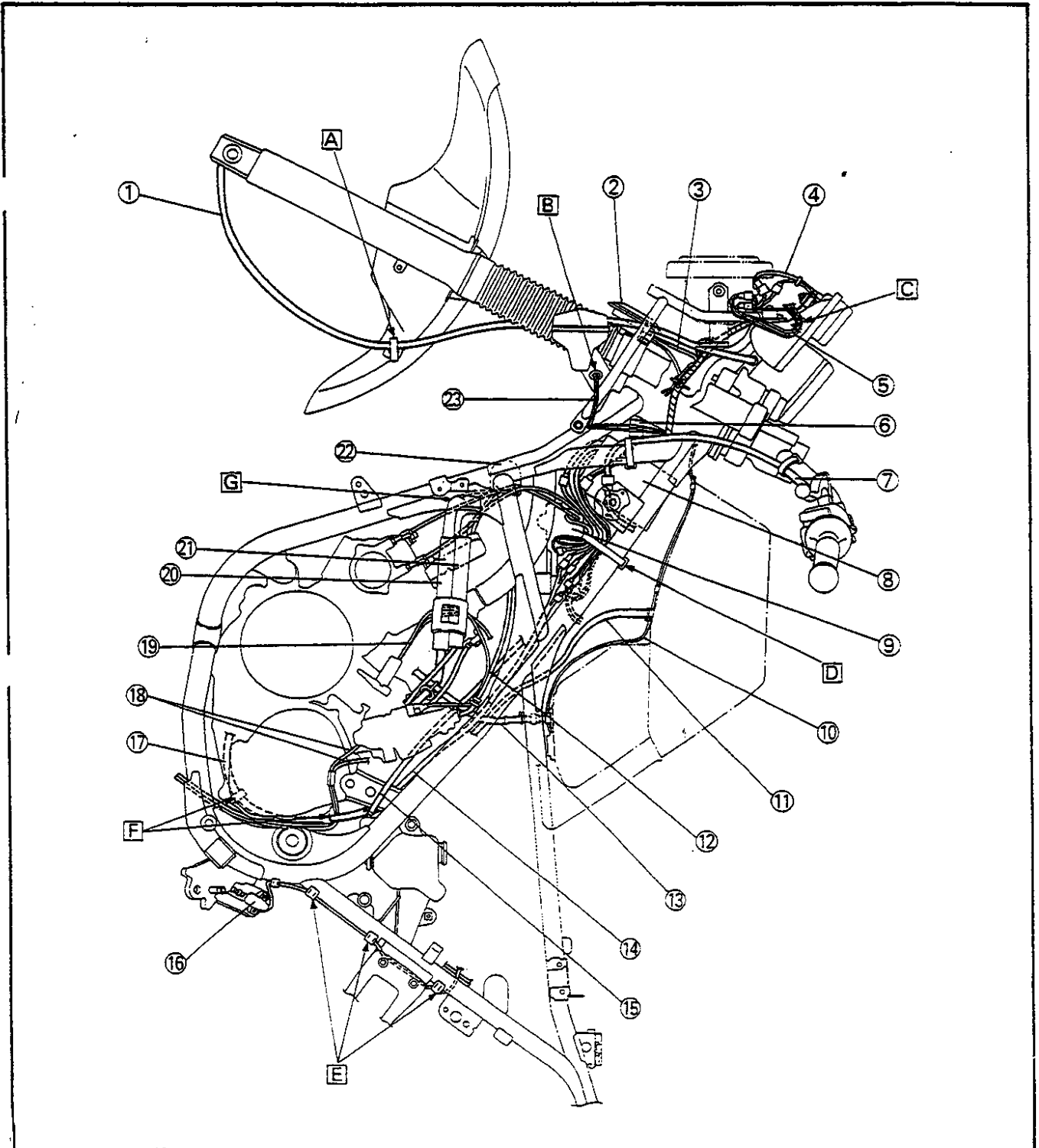

CABLE ROUTING

SPEC



- ① Brake hose
- ② Clutch cable
- ③ Flasher light lead
- ④ Reservoir hose
- ⑤ Thermo unit lead
- ⑥ Oil hose
- ⑦ Battery breather hose
- ⑧ Overflow hose (Fuel tank)
- ⑨ Rear brake switch

- ⑩ Battery positive lead
- ⑪ Battery negative lead
- ⑫ Sidestand switch lead
- ⑬ Throttle cable
- ⑭ Oil pump cable
- ⑮ Servomotor
- ⑯ Rectifier/Regulator
- ⑰ Handlebar switch lead

- A Pass clutch cable through cable guide.
- B Pass flasher light leads through grommet.
- C Hold brake hose with clamp.
- D Pass clutch cable inside of reservoir hose.

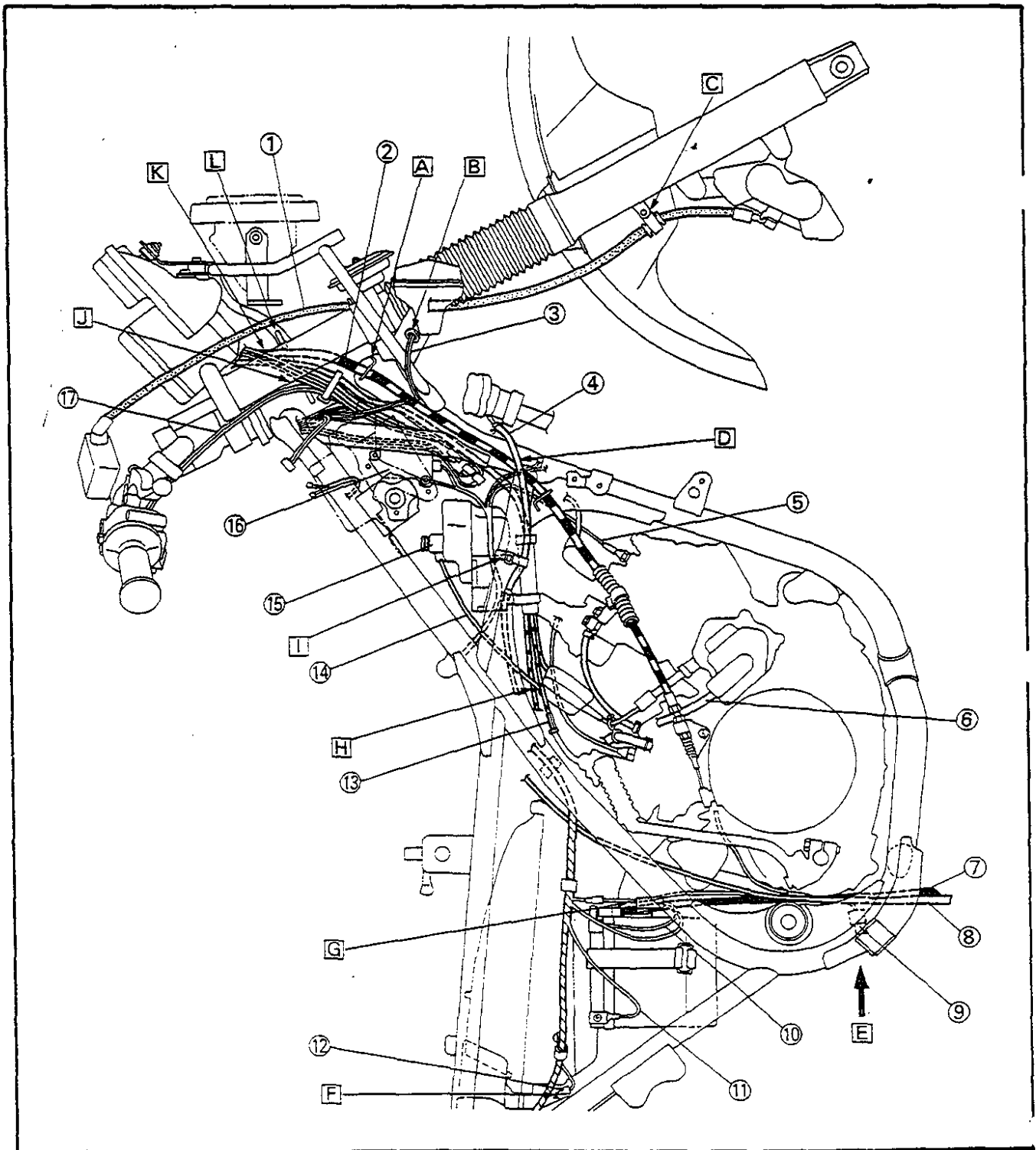

CABLE ROUTING

SPEC



- E** View
- F** Pass sidestand switch lead between mud guard and air cleaner case.
- G** Pass rear brake switch lead inside of circuit braker lead.
- H** Pass oil pump cable between throttle cables.
- I** Hold reservoir hose with band.
- J** Hold throttle cable, main switch lead, front brake switch lead, handlebar switch lead (Right) and speedometer lead with band.
- K** Pass each cables and leads through cable guide.
- L** Pass main switch lead and speedometer lead outside of clutch cable and throttle cable.

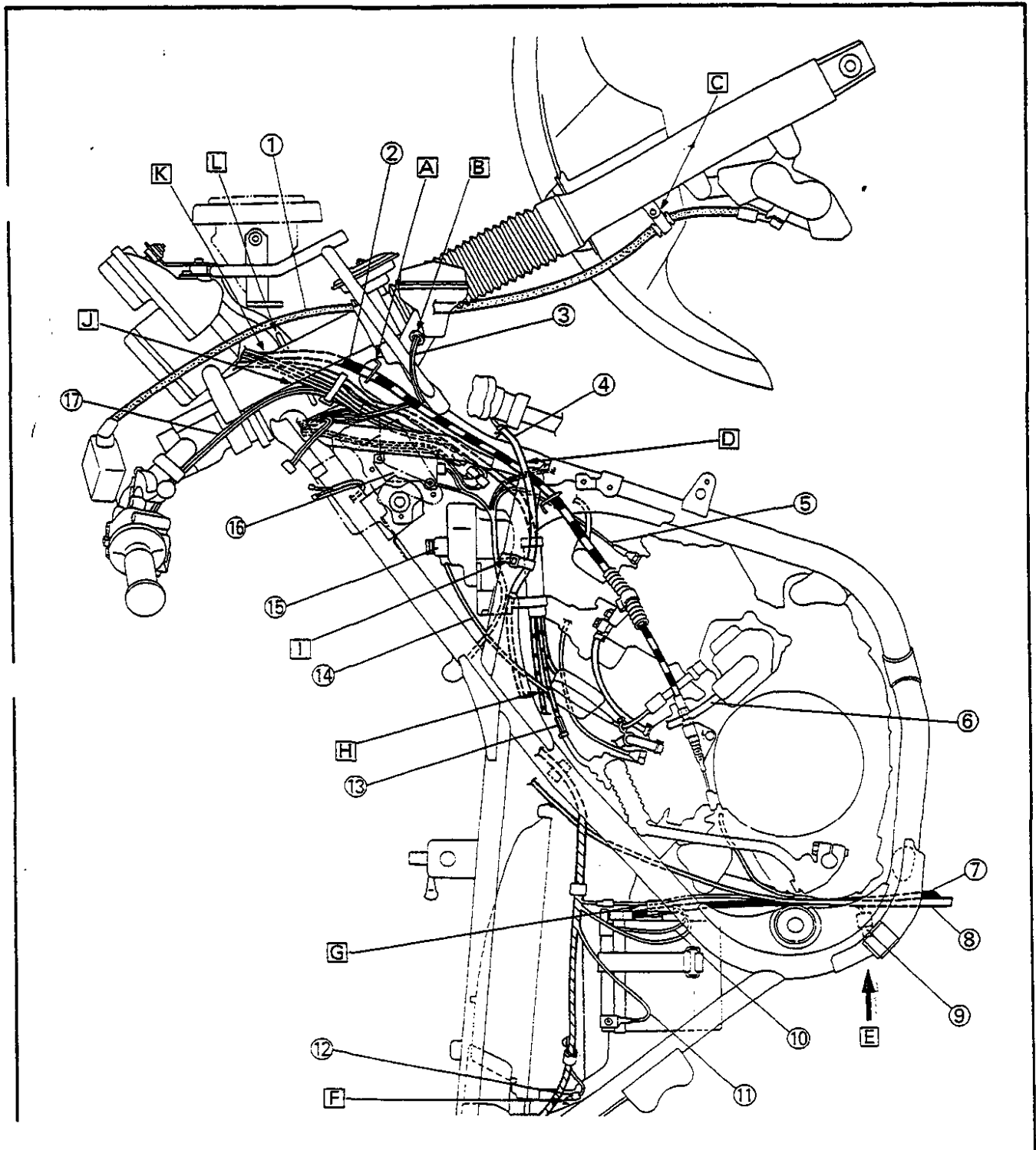



- ① Clamp
- ② Rear brake switch lead
- ③ Rear brake switch
- ④ Battery breather hose
- ⑤ Overflow hose (Fuel tank)
- ⑥ Overflow hose (Carburetor)

Ⓐ Pass hose through hose guide.

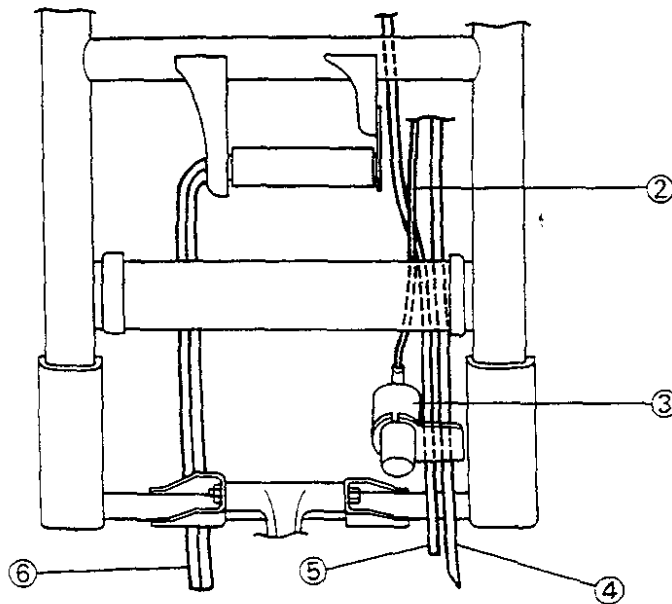
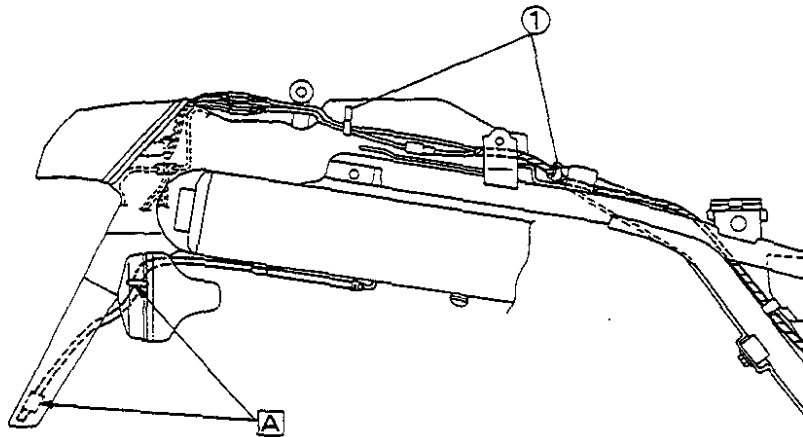

VIEW E

PERIODIC INSPECTION AND ADJUSTMENT

INTRODUCTION

This chapter includes all information necessary to perform recommended inspections and adjustments. These preventive maintenance procedures, if followed, will ensure more reliable vehicle operation and a longer service life. The need for costly overhaul work will be greatly reduced. This information applies to vehicles already in service as well as new vehicles that are being prepared for sale. All service technicians should be familiar with this entire chapter.

PERIODIC MAINTENANCE/LUBRICATION INTERVALS

Unit: km (mi)

ITEM	REMARKS	BREAK-IN 1,000 (600)	EVERY	
			6,000 (4,000) or 6 months	12,000 (8,000) or 12 months
Spark plug(s)	Check condition. Clean or replace if necessary.	○	○	○
Air filter	Clean. Replace if necessary.		○	○
Carburetor*	Check idle speed/synchronization/starter operation. Adjust if necessary.	○	○	○
Fuel line*	Check fuel hose and vacuum hose for cracks or damage. Replace if necessary.		○	○
Transmission oil*	Check oil level/oil leakage. Correct if necessary. Replace every 24,000 (16,000) or 24 months. Warm engine before draining.	REPLACE	○	○
Autolube pump*	Check operation. Correct if necessary. Air bleeding.	○	○	○
YPVS system*	Check operation. Correct if necessary.	○	○	○
Brake*	Check operation/fluid leakage/See NOTE. Correct if necessary.		○	○
Clutch	Check operation. Adjust if necessary.		○	○
Swingarm pivot*	Check swingarm assembly for looseness. Correct if necessary. Moderately repack every 24,000 (16,000) or 24 months. Lubricate.***		○	○
Rear suspension link pivots*	Check operation. Apply grease lightly every 24,000 (16,000) or 24 months. Lubricate.***			○
Wheels*	Check balance/damage/runout. Repair if necessary.		○	○
Wheel bearings*	Check bearing assembly for looseness/damage. Replace if damaged.		○	○
Steering bearing*	Check bearing assembly for looseness. Correct if necessary. Moderately repack every 24,000 (16,000) or 24 months.**	○		○
Front forks*	Check operation/oil leakage. Repair if necessary.		○	○
Rear shock absorber*	Check operation/oil leakage. Repair if necessary.		○	○
Cooling system	Check coolant leakage. Repair if necessary. Replace coolant every 24,000 (16,000) or 24 months.		○	○

PERIODIC MAINTENANCE/LUBRICATION INTERVALS



ITEM	REMARKS	BREAK-IN 1,000 (600)	EVERY	
			6,000 (4,000) or 6 months	12,000 (8,000) or 12 months
Drive chain	Check chain slack/alignment. Adjust if necessary. Clean and lube.	EVERY 500 (300)		
Fittings/Fasteners*	Check all chassis fittings and fasteners. Correct if necessary.	○	○	○
Sidestand*	Check operation. Repair if necessary.	○	○	○
Sidestand switch*	Check operation. Repair if necessary.	○	○	○
Battery*	Check specific gravity. Check breather pipe for proper operation. Correct if necessary.		○	○

*: It is recommended that these items be serviced by a Yamaha dealer.

** : Medium weight wheel bearing grease.

***: Lithium soap base grease

NOTE: _____

Brake system:

1. When disassembling the master cylinder or caliper cylinder, replace the brake fluid. Normally check the brake fluid level and add the fluid as required.
2. We recommended that, on the inner parts of the master cylinder and caliper cylinder, replace the oil seals every two years.
3. We recommended that, replace the brake hoses every four years, or if cracked or damaged.

COWLINGS**REMOVAL**

1. Remove:

- Lever ① (Fuel cock)
- Damper

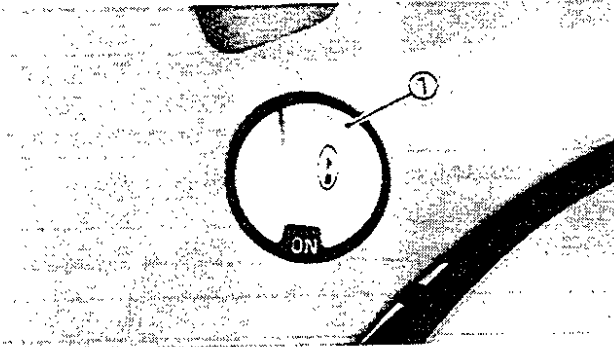

2. Remove:

- Upper cowling ①

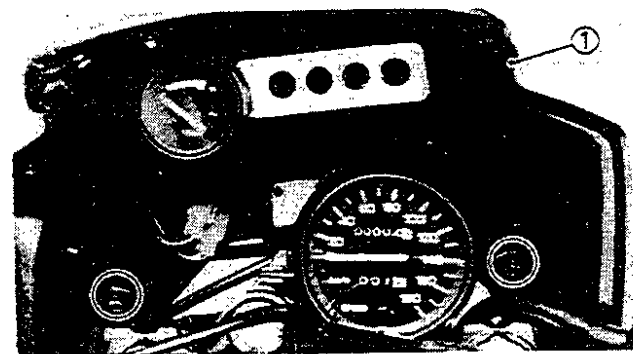
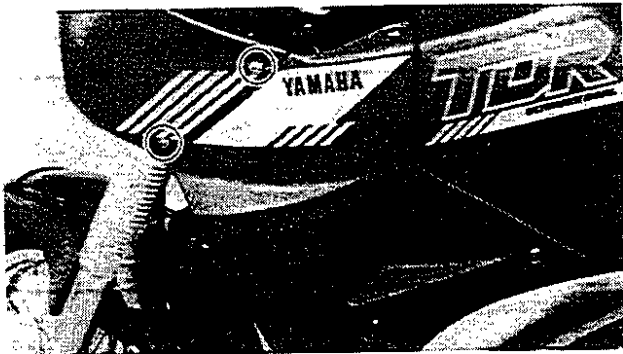

3. Remove:

- Lower cowling ① (Left)
- Lower cowling ② (Right)

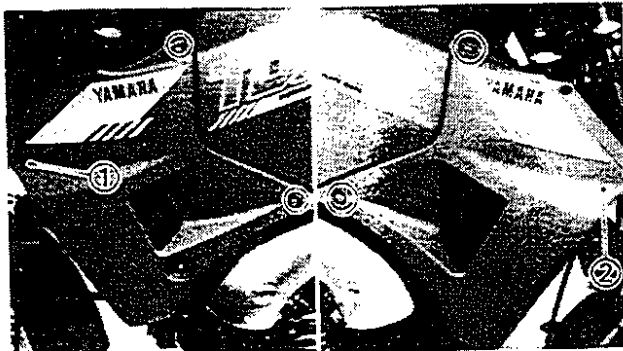
**NOTE:**

Before removing the lower cowling, unhook the pawl ③ out of the opening ④ of the lower cowling.

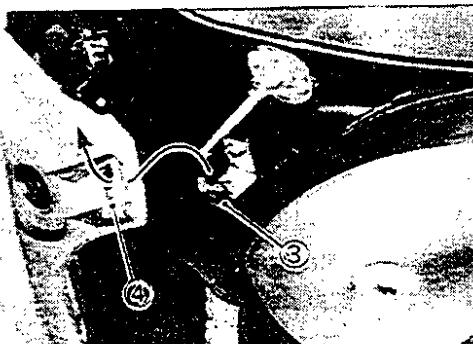

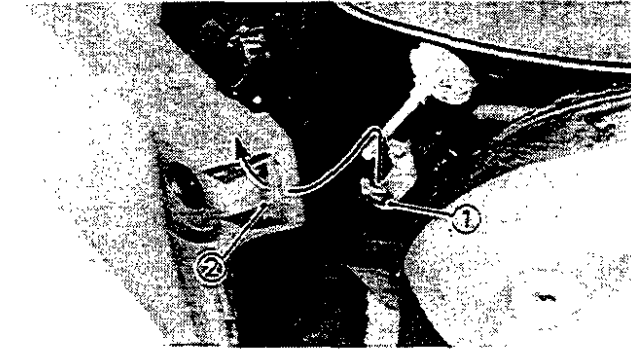

INSTALLATION

Reverse the "REMOVAL" procedure.
Note the following points.

1. Install:
 - Lower cowling (Left)
 - Lower cowling (Right)

NOTE:

Hook the pawl ① onto the opening ②.

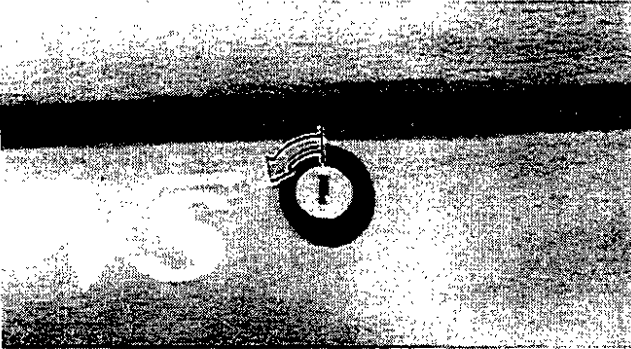

SIDE COVERS

REMOVAL

1. Remove:
 - Seat

NOTE:

To open the seat lock, insert the key in the lock and turn it counterclockwise.

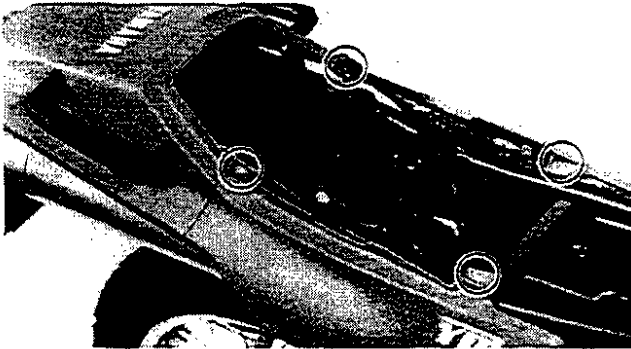

2. Remove:
 - Side cover (Right)
 - Side cover (Left)

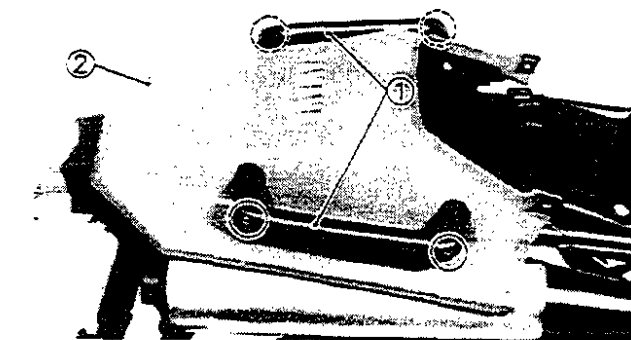

3. Remove:
 - Stays ①
 - Tail cover ②

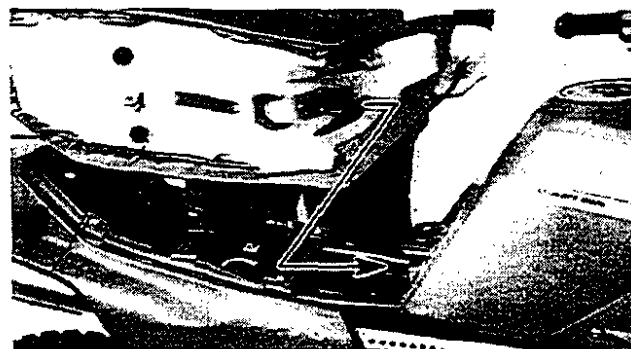

INSTALLATION

Reverse the "REMOVAL" procedure.
Note the following points.

1. Install:
 - Seat

NOTE:

Insert the lobe on the seat front into the receptacle on the frame, then push down the seat.

ENGINE

YPVS CABLE ADJUSTMENT

1. Remove:

- Lower cowling (Right)
- Lower cowling (Left)

Refer to "COWLINGS" section in CHAPTER 3.

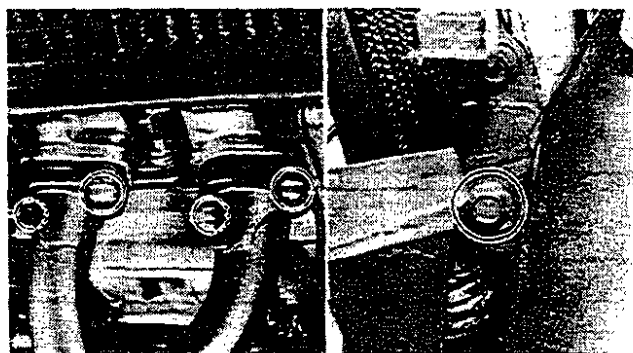

2. Remove:

- Seat
- Side covers
- Tail cover

Refer to "SIDE COVERS" section in CHAPTER 3.

3. Remove:

- Muffler assembly

4. Turn on the main switch.

NOTE:

If does not operate the YPVS motor, refer to the "YPVS SYSTEM" in the CHAPTER 8.

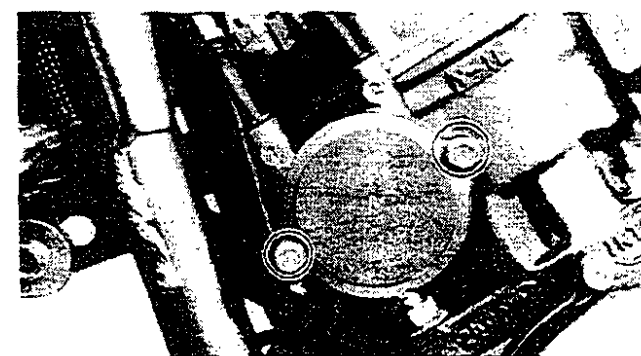
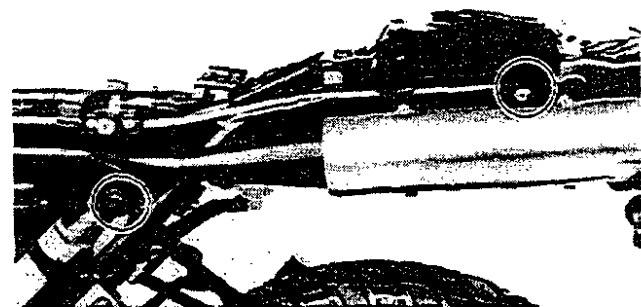

5. Remove:

- Pulley cover (Power valve)

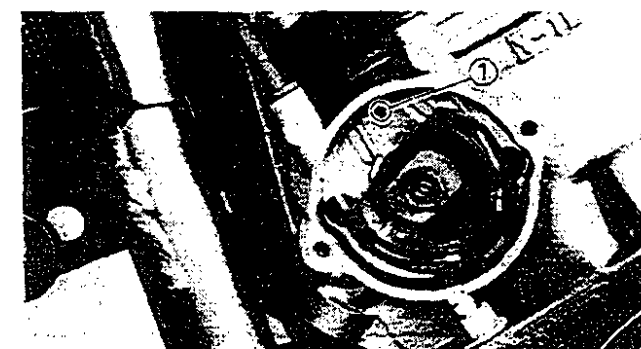

6. Check:

- Alignment mark ①

Not aligned → Adjust the YPVS cables.

YPVS CABLE ADJUSTMENT

INSP
ADJ

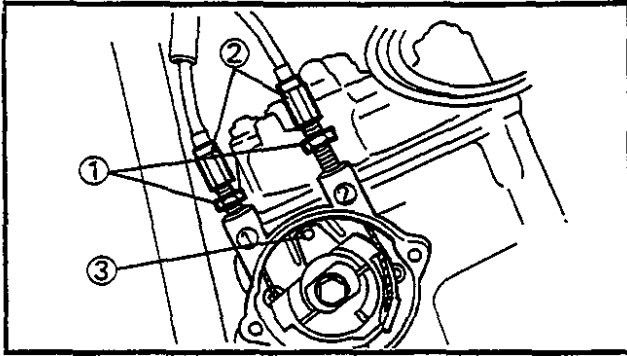

7. Adjust:

- YPVS cables

Adjustment steps:

- Loosen both locknuts ① and turn in both adjusters ②.
- Insert a pin ③ [$\phi 4$ mm ($\phi 0.16$ in)] through the aligning indent in the pulley and into the hole.
- Turn both adjusters, counterclockwise so that the cable free play becomes Zero mm (Zero in) with fingers.
- Turn both adjusters 1/4 turn clockwise.
- Tighten the locknuts.



Locknuts:

8 Nm (0.8 m•kg, 5.8 ft•lb)

- Remove the pin.
- Turn on the main switch and, check that the alignment mark is aligned.
If not, repeat the above steps.

8. Install:

- Pulley cover (Power valve)



Bolts (Pulley Cover):

7 Nm (0.7 m•kg, 5.1 ft•lb)

9. Install:

- Muffler assembly



Nut (Exhaust Pipe)

18 Nm (1.8 m•kg, 13 ft•lb)

Bolt (Muffler—Front):

9 Nm (0.9 m•kg, 6.5 ft•lb)

Bolt (Muffler—Rear):

38 Nm (3.8 m•kg, 27 ft•lb)

10. Install:

- Tail cover
- Side covers
- Seat

Refer to "SIDE COVERS" section in CHAPTER 3.



11. Install:

- Lower cowling (Right)
- Lower cowling (Left)

Refer to "COWLINGS" section in CHAPTER 3.

CARBURETOR SYNCHRONIZATION

NOTE:

Right carburetor and left carburetor must be adjusted to open and close simultaneously.

1. Check:

- Alignment mark ① (on the throttle valve)

Not aligned → Adjust the throttle cable.

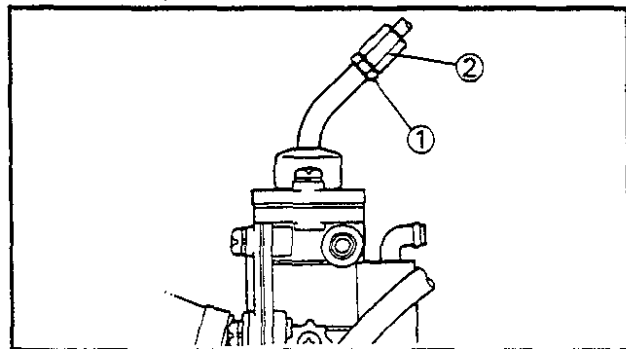
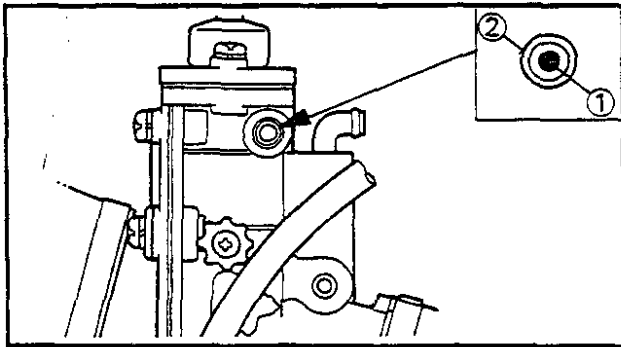

Checking steps:

- Turn the throttle grip until the alignment mark appears in the center of the window ② of the right carburetor.
- While keeping the grip at this position, check the left carburetor window for the presence of the alignment mark at the same position.
- If not, adjust the throttle cable for the left carburetor.

2. Adjust:

- Throttle cables

Adjustment steps:

- Loosen the locknut ①.
- Turn the adjuster ② in or out until the alignment mark comes to the same position.
- Tighten the locknut.
- Finally check that both alignment marks appear at the same position at the same time.
- If not, repeat the above steps.

IDLE SPEED ADJUSTMENT

INSP
ADJ



3. Check:

- Engine idle speed

Refer to "IDLE SPEED ADJUSTMENT" section in CHAPTER 3.



Engine Idle Speed:
1,150 ~ 1,250 r/min

4. Check:

- Throttle cable free play

Refer to "THROTTLE CABLE FREE PLAY ADJUSTMENT" section in CHAPTER 3.



Free Play:
2 ~ 5 mm (0.08 ~ 0.20 in)

IDLE SPEED ADJUSTMENT

NOTE:

The carburetor synchronization must be adjusted properly before adjusting the idle speed.

1. Start the engine and let it warm up.

2. Attach:

- Inductive tachometer
To the spark plug lead.



Inductive Tachometer:
90890-03113

3. Check:

- Engine idle speed

Out of specification → Adjust.



Engine Idle Speed:
1,150 ~ 1,250 r/min

THROTTLE CABLE FREE PLAY ADJUSTMENT

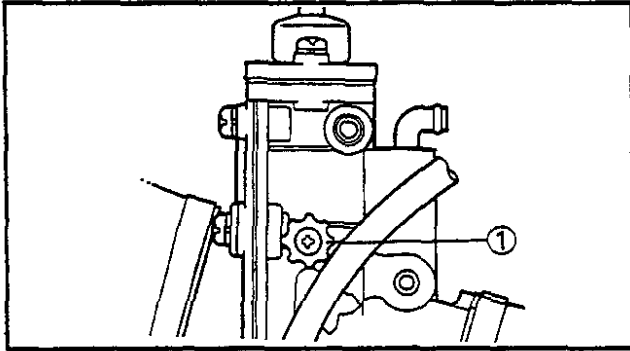

4. Adjust:
- Engine idle speed

Adjustment steps:

- Turn the throttle stop screw ① in or out until specified idle speed is obtained.

Turn in	Idle speed becomes higher.
Turn out	Idle speed becomes lower.

NOTE:

- Left-hand and right-hand throttle stop screws must be set so that both cylinders are working together.
- After adjusting engine idle speed, throttle cable free play should be adjusted.

THROTTLE CABLE FREE PLAY ADJUSTMENT

NOTE:

Before adjusting the throttle cable free play, the engine idle speed and carburetor synchronization should be adjusted.

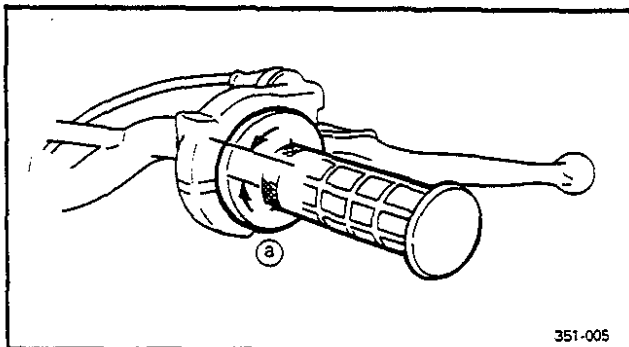

351-005

1. Check:
- Throttle cable free play ①
Out of specification → Adjust.



Throttle Cable Free Play:
2–5 mm (0.08–0.20 in)

2. Adjust:
- Throttle cable free play

Adjustment steps:

- Loosen the locknut ①.
- Turn the adjuster ② in or out until the correct free play is obtained.

Turn in	Free play is increased.
Turn out	Free play is decreased.

- Tighten the locknut.

WARNING:

After adjusting, turn the handlebar to right and left and make sure that the engine idles does not run faster.

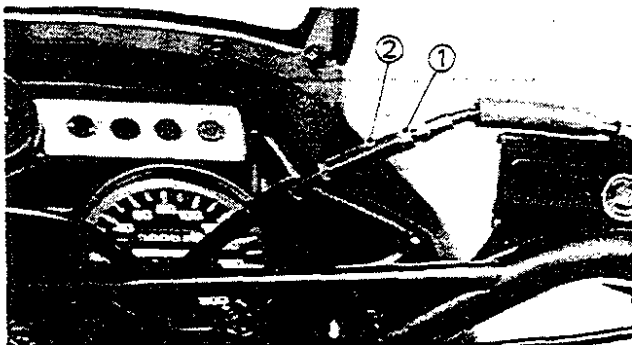

AUTOLUBE PUMP CABLE ADJUSTMENT

NOTE:

Before adjusting Autolube pump cable, carburetor synchronization and throttle cable free play should be adjusted.

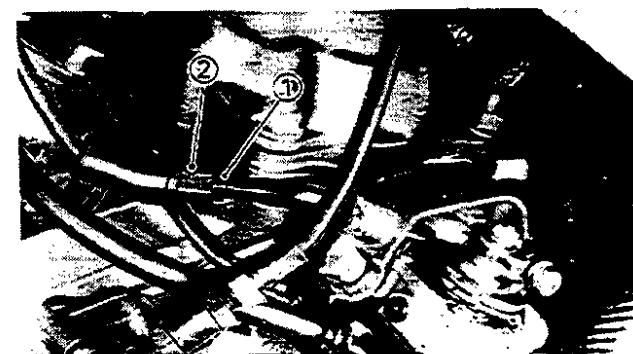
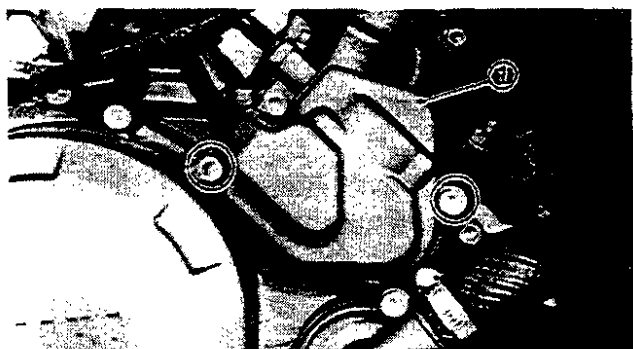

1. Remove:
 - Autolube pump cover ①
2. Turn on the main switch.
3. Fully open the throttle grip and hold it at this position.
4. Check:
 - Alignment mark ①
 - Not aligned → Adjust Autolube pump cable.
5. Adjust:
 - Autolube pump cable

Adjustment steps:

- Loosen the locknut ①.
- Turn the adjuster ② in or out until the alignment mark is aligned with the pin.
- Tighten the locknut.

6. Install:
 - Autolube pump cover



Bolts (Autolube Pump Cover):
6 Nm (0.6 m·kg, 4.3 ft·lb)

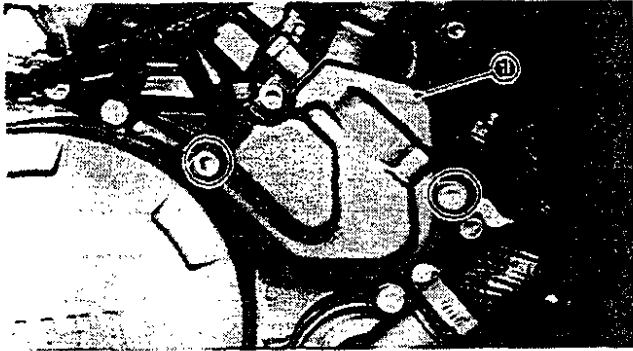

AUTOLUBE PUMP STROKE ADJUSTMENT

1. Remove:
 - Autolube pump cover ①
2. Start the engine and let it warm up.
3. While running the engine at idle, observe the pump adjusting plate carefully. Stop the engine moment that the adjusting plate ① moves out to its limit.
4. Measure:
 - Gap
 - Out of specification → Adjust.
 - Measure the gap with the thickness gauge between the raised boss ② on the pump adjusting pulley and the adjusting plate ①.



Minimum Pump Stroke:
0.15 ~ 0.20 mm (0.006 ~ 0.008 in)

NOTE:

When inserting the thickness gauge between the adjusting plate and the adjusting pulley, be careful so that neither the plate nor the pulley is moved. In other words, do not force the thickness gauge into the gap.

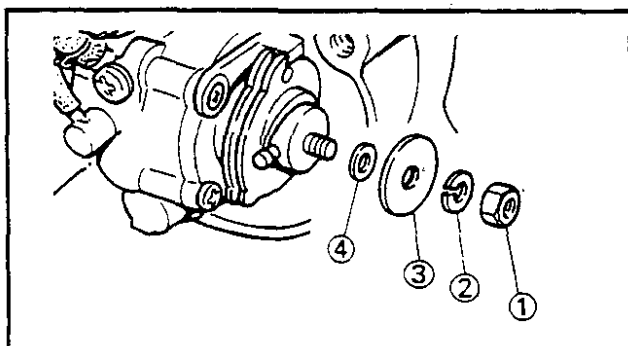

5. Adjust:
 - Autolube pump minimum stroke

Adjustment steps:

- Remove the locknut ①, spring washer ② and adjusting plate ③.
- Adjust the pump stroke by adding or removing a shim ④.

AUTOLUBE PUMP AIR BLEEDING



Add shim	Pump stroke is increased.
Remove shim	Pump stroke is decreased.
•Install the adjusting plate, spring washer and locknut.	
	Locknut: 7 Nm (0.7 m•kg, 5.1 ft•lb)
•Recheck the minimum pump stroke. If out of specification, perform the above steps again.	

6. Install:

- Autolube pump cover

	Bolts (Autolube Pump Cover): 6 Nm (0.6 m•kg, 4.3 ft•lb)
---	---

AUTOLUBE PUMP AIR BLEEDING

NOTE:

The Autolube pump and delivery lines must be bled on the following occasions:

- Setting up a new motorcycle out of the crate.
- Whenever the oil tank has run dry.
- Whenever any portion of the engine oil system is disconnected.

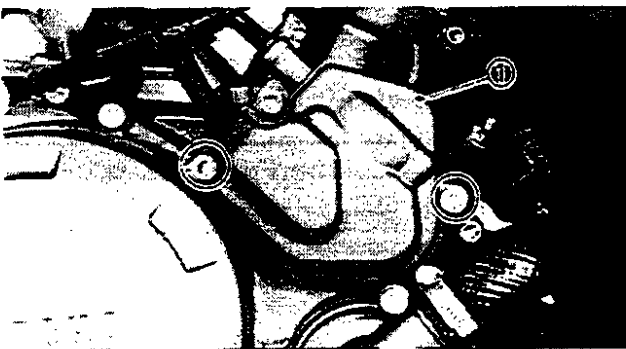

1. Remove:

- Autolube pump cover ①



2. Air bleed:

- Pump case and/or oil pipe

Air bleeding steps:

- Remove the bleed screw ①.
- Keep the oil running out until air bubbles disappear.

SPARK PLUG INSPECTION



- When air bubbles are expelled completely, tighten the bleed screw.

NOTE: _____

Check the bleed screw gasket, and if damaged, replace with a new one.

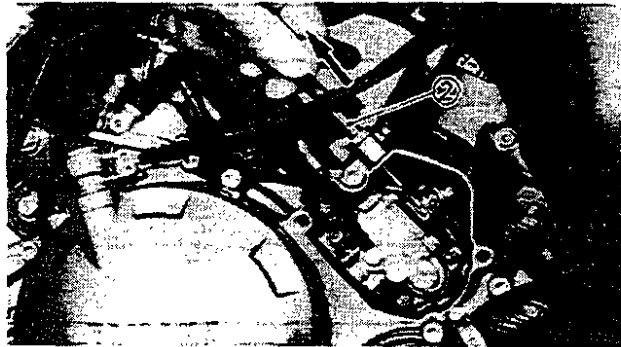
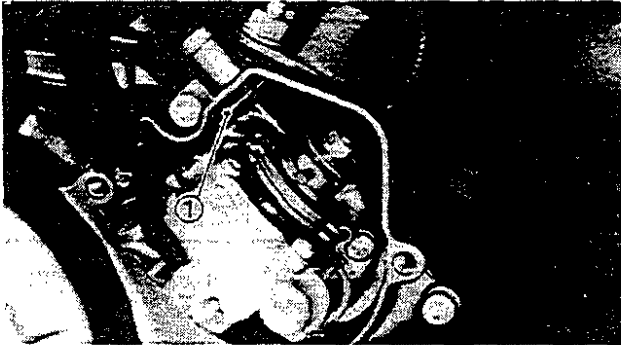

3. Air bleed:

- Pump distributor and/or delivery pipe

Air bleeding steps:

- Remove the clip ①.
- Start the engine.
- Pull the pump cable ② all the way out to set the pump stroke to a maximum.

NOTE: _____

It is difficult to bleed the distributor completely with the pump stroke at a minimum, and therefore the pump stroke should be set to a maximum.

- Keep the engine running at about 2,000 r/min for two minutes or so, and both distributor and delivery pipe can be completely bled.

4. Install:

- Clip
- Autolube pump cover



Bolts (Autolube Pump Cover):
6 Nm (0.6 m•kg, 4.3 ft•lb)

SPARK PLUG INSPECTION

1. Remove:

- Lower cowling (Right)
- Lower cowling (Left)

Refer to the "COWLINGS" section in the CHAPTER 3.

SPARK PLUG INSPECTION



2. Remove:
 - Spark plug
3. Inspect:
 - Spark plug type
Incorrect → Replace.

**Standard Spark Plug:
BR9ES (N.G.K.)**

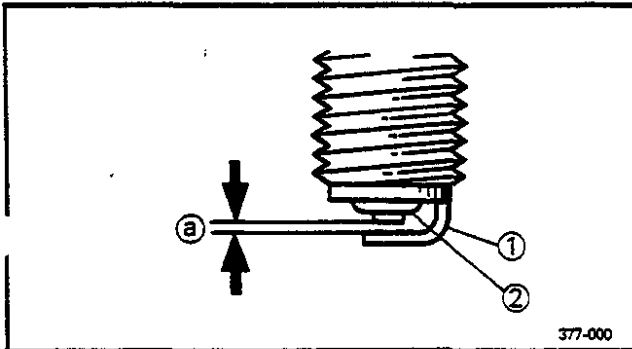

4. Inspect:
 - Electrode ①
Wear/Damage → Replace.
 - Insulator ②
Abnormal color → Replace
Normal color is a medium-to-light tan color.
5. Clean the spark plug with a spark plug cleaner or wire brush.
6. Measure:
 - Plug gap ③
Use a Wire Gauge or Feeler Gauge.
Out of specification → Regap.

 **Spark Plug Gap:**
0.7 ~ 0.8 mm (0.028 ~ 0.032 in)

7. Tighten:
 - Spark plug(s)
Before installing a spark plug, clean the gasket and plug surfaces.

 **Spark Plug:**
20 Nm (2.0 m•kg, 14 ft•lb)

NOTE: _____
Finger-tighten the spark plug(s) before torquing to specification.

8. Install:
 - Lower cowling (Left)
 - Lower cowling (Right)

IGNITION TIMING CHECK

INSP
ADJ



IGNITION TIMING CHECK

1. Remove:

- AC Generator cover ①

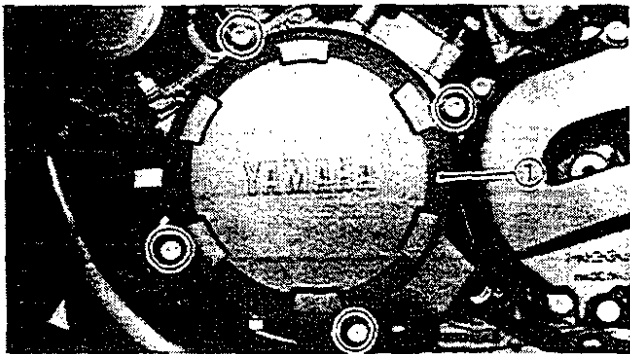

2. Attach:

- Timing Light
 - Inductive Tachometer
- To #1 spark plug lead (Left).



Timing Light:

90890-03109

Inductive Tachometer:

90890-03113

3. Check:

- Ignition timing

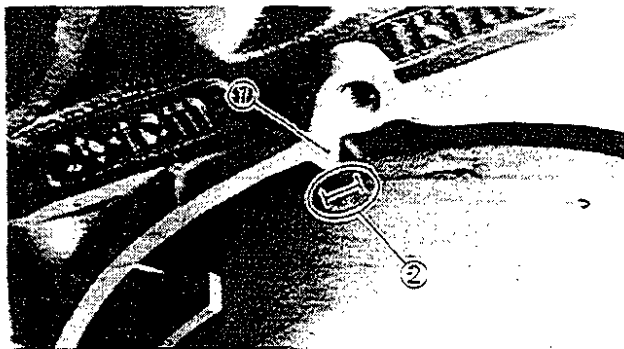

Checking steps:

- Warm up the engine and let it at the specified speed.



Engine Speed:

1,200 r/min

- Visually check the stationary pointer ① to verify it is within the required firing range ② indicated on the flywheel.

Incorrect firing range → Check timing plate and/or pickup assembly (tightness damage).

4. Install:

- AC Generator cover



Bolts (AC Generator Cover):

5 Nm (0.5 m•kg, 3.6 ft•lb)

ENGINE OIL LEVEL CHECK

1. Check:
 - Oil level
 - Oil level low → Add sufficient oil.



Recommended Oil:
Yamaha Oil 2T or Air Cooled 2 Stroke Engine Oil

Oil Tank Capacity:
1.4 L (1.2 Imp qt, 1.5 US qt)

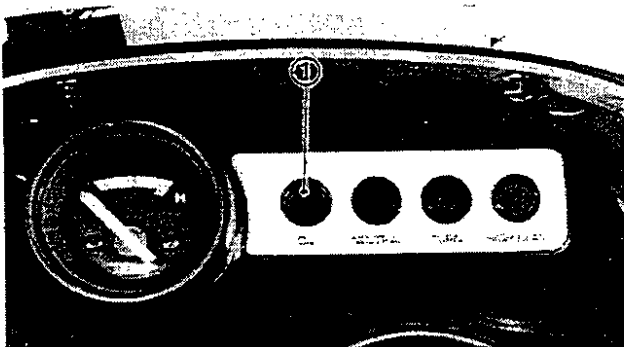
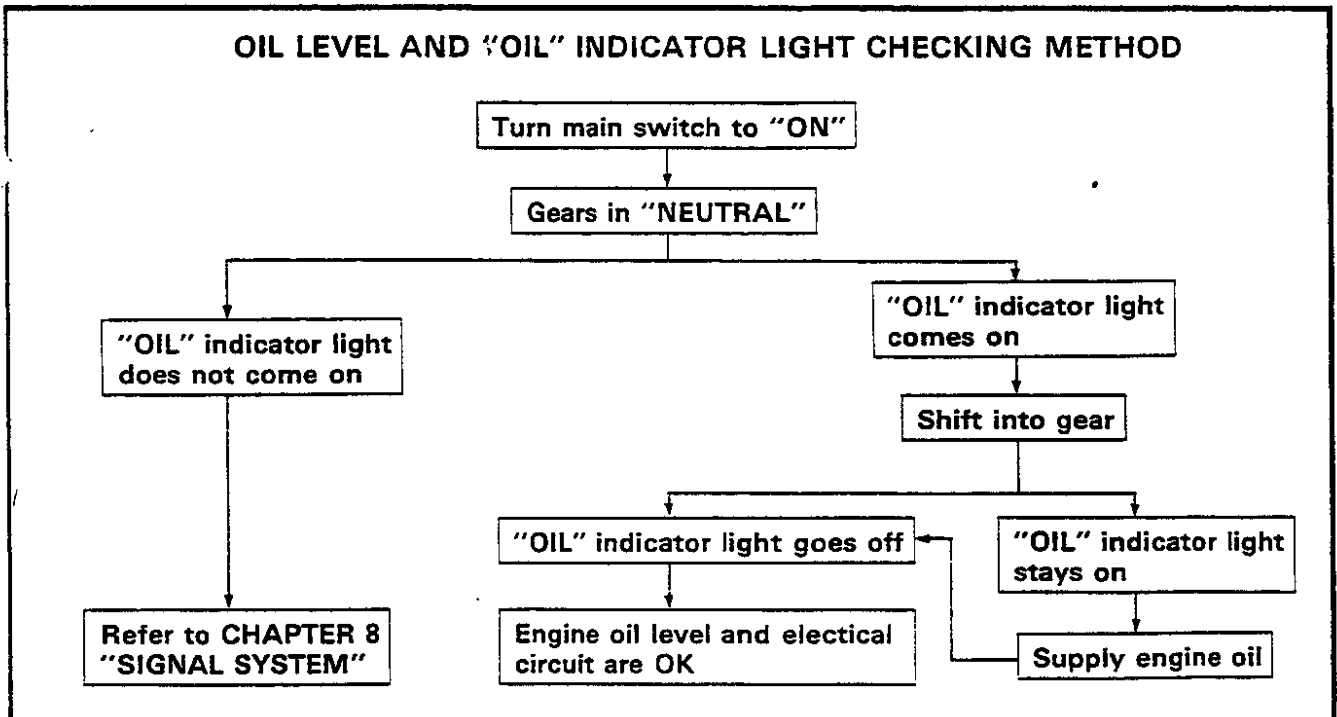

① "OIL" indicator light

CAUTION:

Always use the same type of engine oil; mixing oils may result in a harmful chemical reaction and lead to poor performance.

TRANSMISSION OIL LEVEL INSPECTION/ TRANSMISSION OIL REPLACEMENT

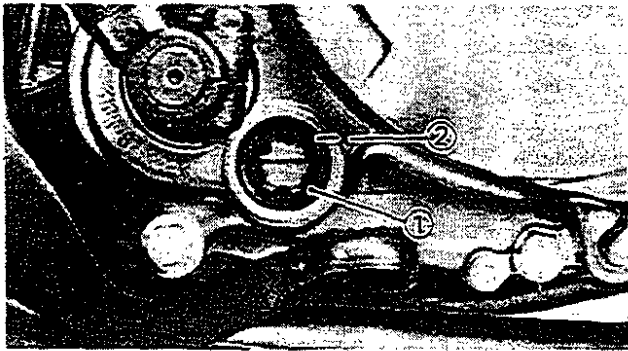

TRANSMISSION OIL LEVEL INSPECTION

1. Place the motorcycle on a level surface and warm up the engine for several minutes.
2. Stop the engine and inspect the oil level through the level window ①.

NOTE:

Wait a few minutes until level settles before inspecting.

3. Inspect:

- Oil level
- Oil level should be reached to level mark ②.
- Oil level low → Add oil to proper level.



Recommended Oil:
SAE 10W30 Type SE Motor Oil

NOTE:

Position motorcycle straight up when inspecting oil level, a slight tilt to the side can produce false readings.

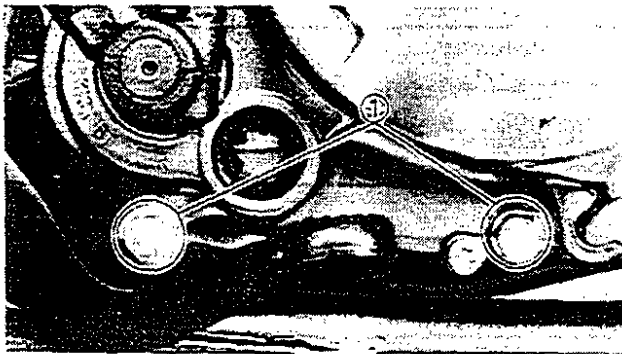

TRANSMISSION OIL REPLACEMENT

1. Warm up the engine for several minutes.
2. Place an open container under the engine.
3. Remove:
 - Oil filler cap
 - Drain bolts ①
4. Drain:
 - Transmission oil

NOTE:

Drain the transmission oil with the motorcycle slightly inclined to the right.

CLUTCH ADJUSTMENT

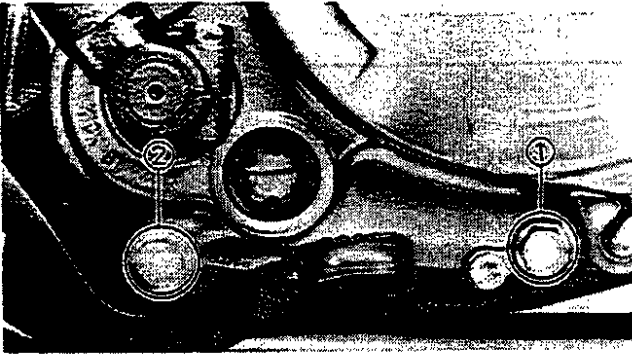
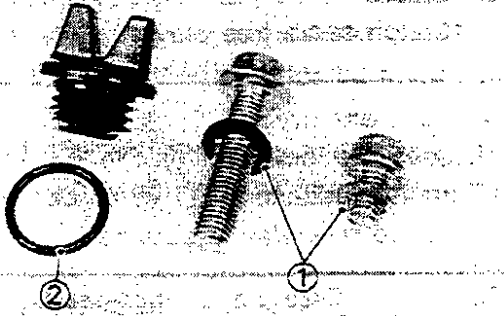

5. Inspect:

- Gasket ① (Drain bolt)
 - O-ring ② (Oil filler cap)
- Damage → Replace.

6. Install:

- Drain bolts

	Drain Bolt ①:
	16 Nm (1.6 m·kg, 11 ft·lb)
	Drain Bolt ②:
	22 Nm (2.2 m·kg, 16 ft·lb)

7. Fill:

- Crankcase

	Recommended Oil:
	SAE 10W30 Type SE Motor Oil
	Oil Capacity:
	1.0 L (0.9 Imp qt, 1.1 US qt)

CAUTION:

- Do not allow foreign material to enter the crankcase.
- Do not add any chemical additives. Transmission oil also lubricates the clutch and additives could cause clutch slippage.

8. Install:

- Oil filler cap

CLUTCH ADJUSTMENT

1. Check:

- Clutch cable free play ①
- Out of specification → Adjust.

	Free Play:
	10 ~ 15 mm (0.4 ~ 0.6 in)

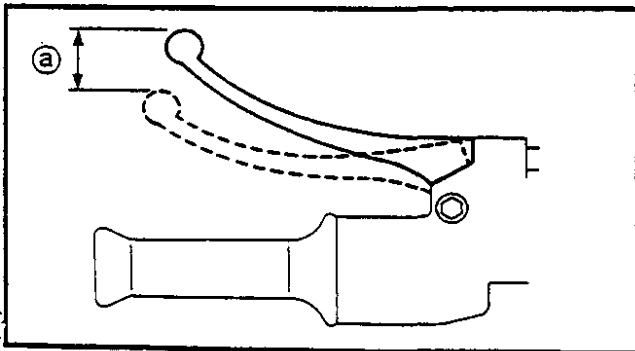

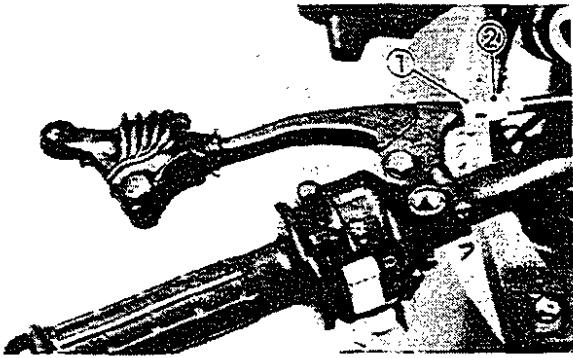

2. Adjust:

- Clutch cable free play

Adjustment steps:

- Loosen the locknuts ①.
- Turn the adjusters ② in or out until the specified free play is obtained.

Turn in	Free play is increased.
Turn out	Free play is decreased.

- Tighten the locknuts.

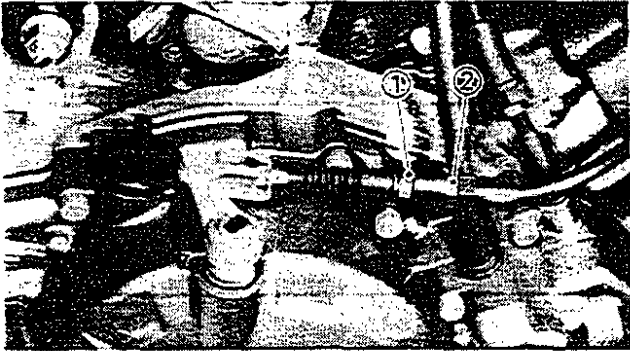

AIR FILTER CLEANING

1. Remove:

- Seat

NOTE:

To open the seat lock, insert the key in the lock and turn it counterclockwise.

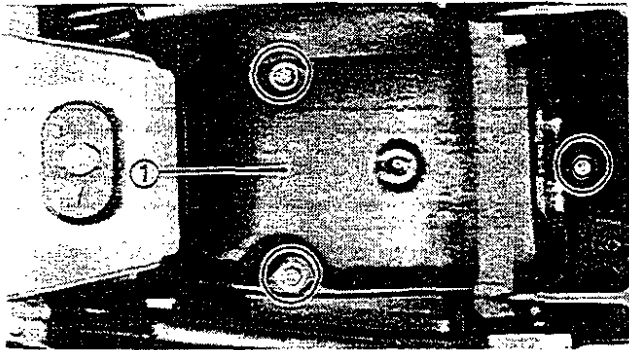

2. Remove:

- Air filter case cover ①

3. Remove:

- Air filter element ①

CAUTION:

Never operate the engine with the air filter element removed. This will allow unfiltered air to enter, causing rapid wear and possible engine damage. Additionally, operation without the filter element will affect carburetor tuning with subsequent poor performance and possible engine overheating.

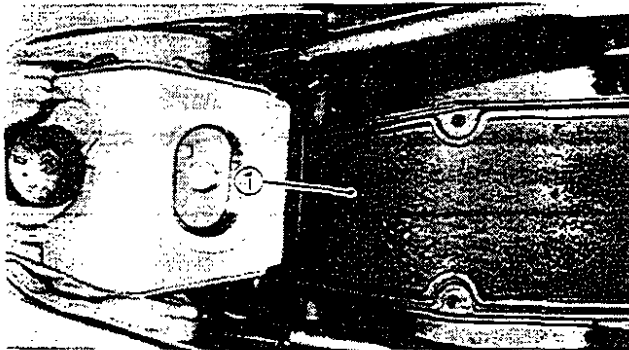

4. Clean:

- Air filter element

Cleaning steps:

- Wash the element gently, but thoroughly in solvent.



WARNING:

Never use low flash point solvents such as gasoline to clean the element. Such solvent may lead to a fire or explosion.

- Squeeze the excess solvent out of the element and let dry.

CAUTION:

Do not twist the element when squeezing the element.

5. Inspect:

- Element
Damage → Replace.

6. Apply:

- Air-Cooled 2 stroke engine oil or Yamaha oil 2T
Onto the element.

7. Squeeze out the excess oil.

NOTE:

The element should be wet but not dripping.

8. Install:

- Air filter element

CAUTION:

Make sure the element edge fits into the corresponding filter case groove.

9. Install:

- Air filter case cover
• Seat

NOTE:

Insert the lobe on the seat front into the receptacle on the frame, then push down the seat.

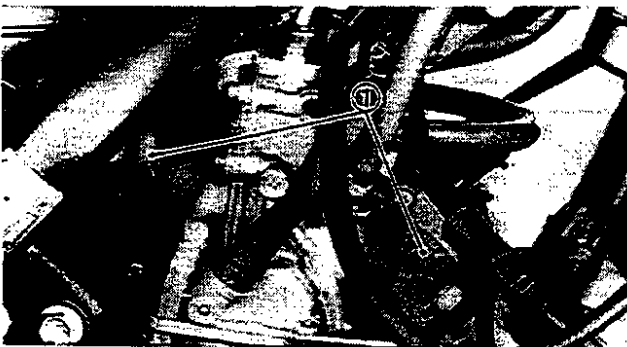

CARBURETOR JOINT INSPECTION

1. Inspect:

- Carburetor joints ①
Cracks/Damage → Replace.
Refer to the "CHAPTER 6—CARBURETION" section for replacement.

FUEL LINE INSPECTION

1. Remove:
 - Lower cowling (Right)
 - Lower cowling (Left)
 Refer to "COWLINGS" section in CHAPTER 3.
2. Remove:
 - Seat
 - Side covers
 - Tail cover
 Refer to "SIDE COVERS" section in CHAPTER 3.
3. Remove:
 - Muffler assembly

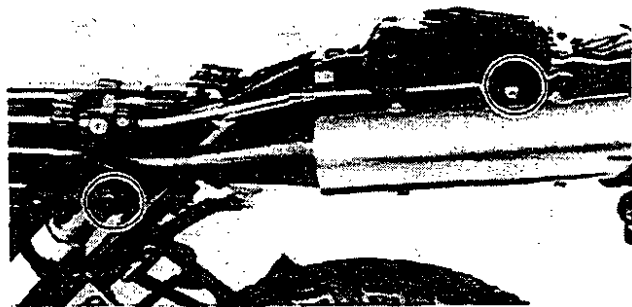
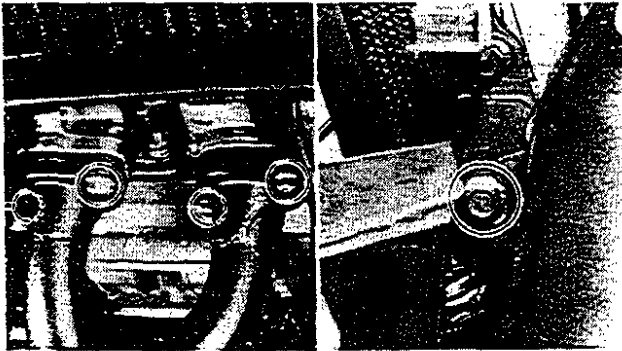

4. Inspect:
 - Fuel delivery hoses ①
 - Vacuum hose ②
 Cracks/Damage → Replace.

5. Install:
 - Muffler assembly

	<p>Nut (Exhaust Pipe): 18 Nm (1.8 m•kg, 13 ft•lb)</p> <p>Bolt (Muffler—Front): 9 Nm (0.9 m•kg, 6.5 ft•lb)</p> <p>Bolt (Muffler—Rear): 38 Nm (3.8 m•kg, 27 ft•lb)</p>
---	---

6. Install:
 - Tail cover
 - Side covers
 - Seat
 Refer to "SIDE COVERS" section in CHAPTER 3.
7. Install:
 - Lower cowling (Right)
 - Lower cowling (Left)
 Refer to "COWLINGS" section in CHAPTER 3.

EXHAUST SYSTEM INSPECTION

1. Remove:
 - Lower cowling (Right)
 - Lower cowling (Left)
 Refer to "COWLINGS" section in CHAPTER 3.
2. Remove:
 - Seat
 - Side covers
 - Tail cover
 Refer to "SIDE COVERS" section in CHAPTER 3.
3. Inspect:
 - Exhaust pipes
 - Mufflers
 - Cracks/ Damage → Replace.
 - Gaskets
 - Exhaust gas leaks → Replace.
4. Tighten:
 - Nut ① (Exhaust pipe)
 - Bolt ② (Muffler—Front)
 - Bolt ③ (Muffler—Rear)

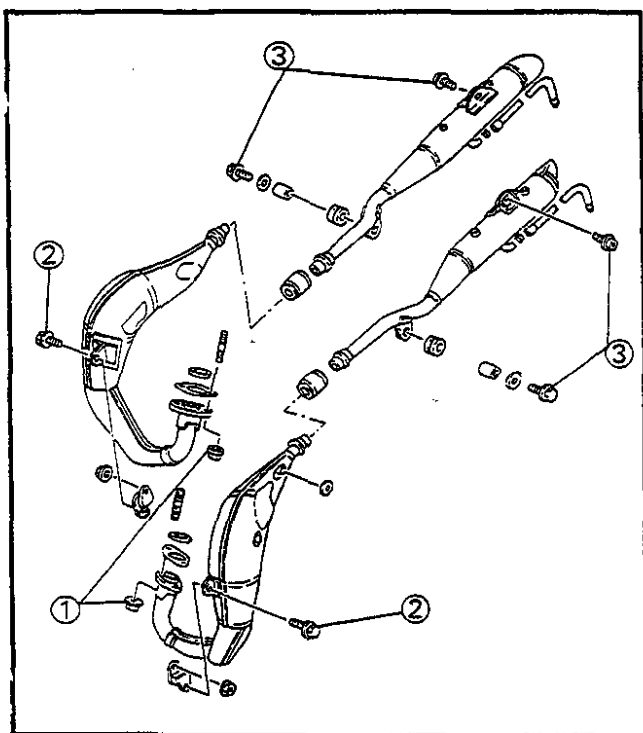

	Nut (Exhaust Pipe): 18 Nm (1.8 m•kg, 13 ft•lb) Bolt (Muffler—Front) 9 Nm (0.9 m•kg, 6.5 ft•lb) Bolt (Muffler—Rear) 38 Nm (3.8 m•kg, 27 ft•lb)
---	---

5. Install:

- Tail cover
- Side covers
- Seat

Refer to "SIDE COVERS" section in CHAPTER 3.

6. Install:

- Lower cowling (Right)
- Lower cowling (Left)

Refer to "COWLINGS" section in CHAPTER 3.

COOLANT LEVEL INSPECTION

1. Place the motorcycle on a level surface and warm up the engine.

2. Stop the engine.

NOTE: _____

Wait a few minutes until the coolant level settles before inspecting.

3. Inspect:

- Coolant level

Coolant level is under low level line ① →
Add soft water (tap water).

NOTE: _____

Position the motorcycle straight up when inspecting the coolant level, a slight tilt to the side can produce false readings.

CAUTION: _____

Hard water or salt water is harmful to the engine parts. You may use boiled water or distilled water, if you can't get soft water.

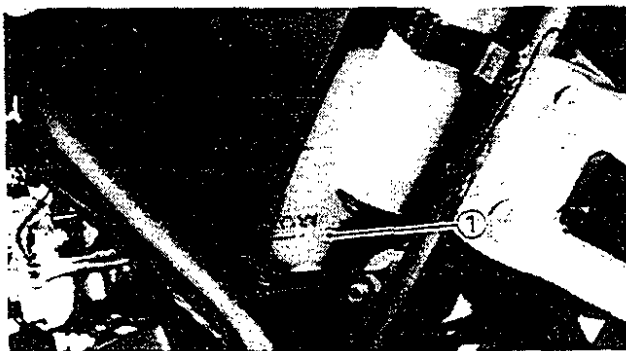

COOLANT REPLACEMENT

INSP
ADJ

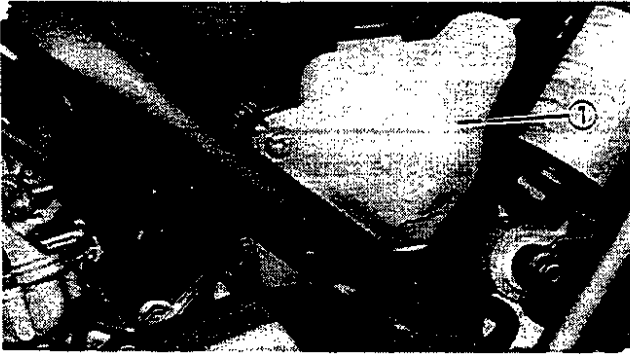

4. Add:
 - Soft water (tap water)To reservoir tank.

Adding steps:

- Remove the seat and side cover (Left). Refer to the "SIDE COVERS" section in CHAPTER 3.
- Add the soft water (tap water) until the coolant level reaches "FULL" level mark ①.
- Install the side cover (Left) and seat. Refer to the "SIDE COVERS" section in CHAPTER 3.

COOLANT REPLACEMENT

1. Remove:
 - Lower cowlings
Refer to "COWLINGS" section in CHAPTER 3.
2. Remove:
 - Seat
 - Side cover (Left)
Refer to "SIDE COVERS" section in CHAPTER 3.
3. Remove:
 - Radiator cover ①

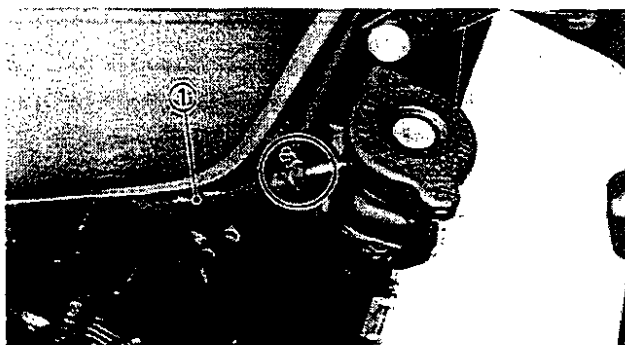
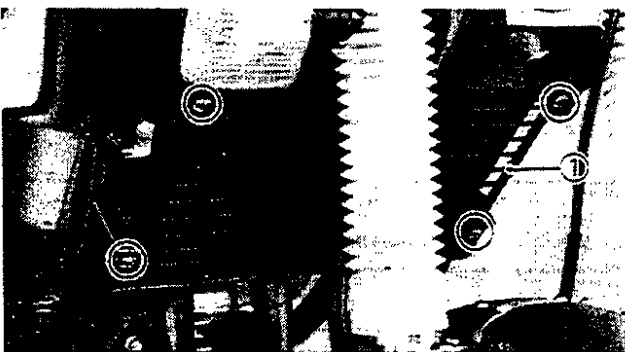

4. Disconnect:
 - Breather hose ①
5. Drain the reservoir tank of its coolant:

COOLANT REPLACEMENT

INSP
ADJ

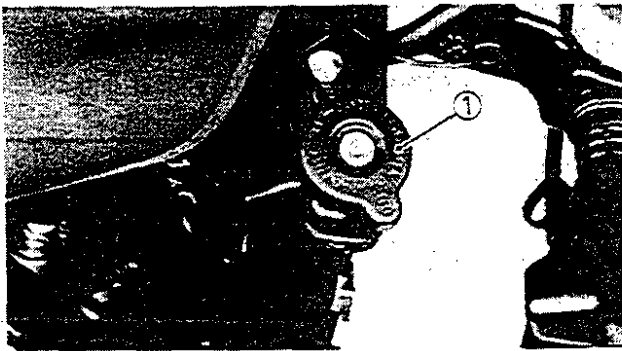

6. Remove:
- Radiator cap ①

WARNING:

Do not remove the radiator cap when the engine and radiator are hot. Scalding hot fluid and steam may be blown out under pressure, which could cause serious injury. When the engine has cooled, open the radiator cap by the following procedure: Place a thick rag, like a towel, over the radiator cap, slowly rotate the cap counterclockwise to the detent. This procedure allows any residual pressure to escape. When the hissing sound has stopped, press down on the cap while turning counterclockwise and remove it.

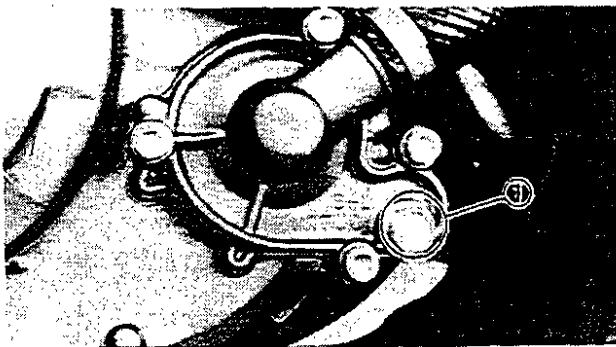

7. Remove:
- Drain bolt ①

8. Drain:
- Coolant

NOTE:

Drain the coolant with the motorcycle slightly inclined to the right.

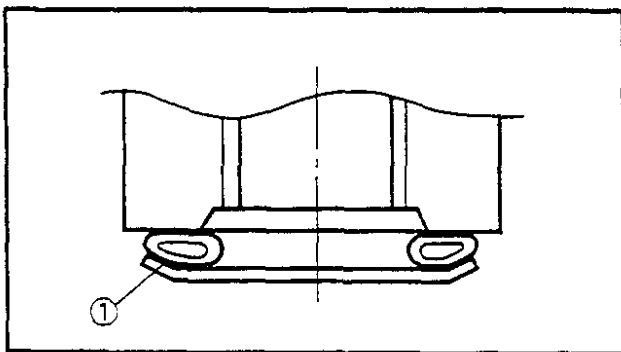

9. Install:
- Gasket ①
Use new one.
 - Drain bolt



Drain Bolt:
16 Nm (1.6 m•kg, 11 ft•lb)

NOTE:

Install the gasket as shown.

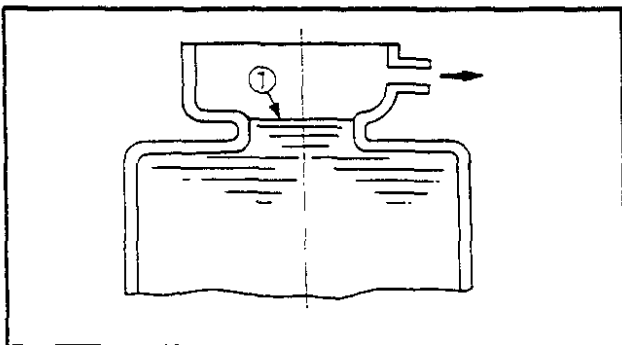

10. Fill:
- Radiator
 - Engine
To specified level ①.

**Recommended Coolant:**

High Quality Ethylene Glycol
Anti-freeze Containing
Anti-corrosion for
Aluminum Engine Inhibitors
Coolant and Water (Soft Water)

Mixed Ratio:

50%/50%

Total Amount:

1.45 L (1.27 Imp qt, 1.53 US qt)

Reservoir Tank Capacity:

0.35 L (0.31 Imp qt, 0.37 US qt)

Handling notes of coolant:

The coolant is harmful so it should be handled with special care.

WARNING:

- When coolant splashes to your eye. Thoroughly wash your eye with water and see your doctor.
- When coolant splashes to your clothes. Quickly wash it away with water and then with soap.
- When coolant is swallowed. Quickly make him vomit and take him to a doctor.

CAUTION:

- Hard water or salt water is harmful to the engine parts; use boiled or distilled water if you can't get soft water.
- Do not use water containing impurities or oil.
- Take care so that coolant does not splash to painted surfaces. If splashes, wash it away with water.

COOLANT REPLACEMENT

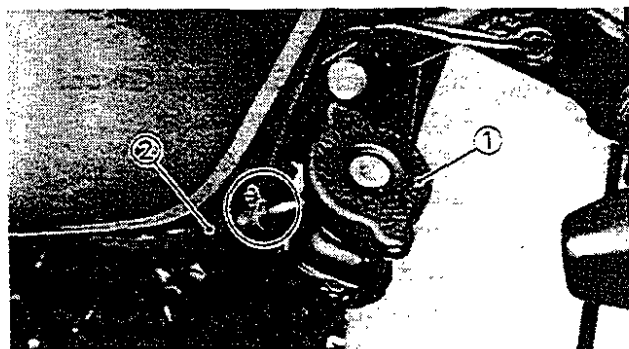

11. Install:
 - Radiator cap ①
12. Connect:
 - Breather hose ②
13. Fill the reservoir tank with the coolant until the coolant level reaches "FULL" level mark ①.
14. Install:
 - Radiator cover
15. Start the engine and let it warm up.
16. Stop the engine and inspect the coolant level.

NOTE: _____
Wait a few minutes until the coolant level settles before inspecting.

17. Inspect:
 - Coolant level
 - Coolant level is under low level line ① →
Add coolant.

NOTE: _____
Position the motorcycle straight up when inspecting the coolant level, a slight tilt to the side can produce false readings.

18. Install:
 - Side cover (Left)
 - Seat
 - Refer to "SIDE COVERS" section in CHAPTER 3.
19. Install:
 - Lower cowlings
 - Refer to "COWLINGS" section in CHAPTER 3.

COOLING SYSTEM INSPECTION/ FRONT BRAKE ADJUSTMENT

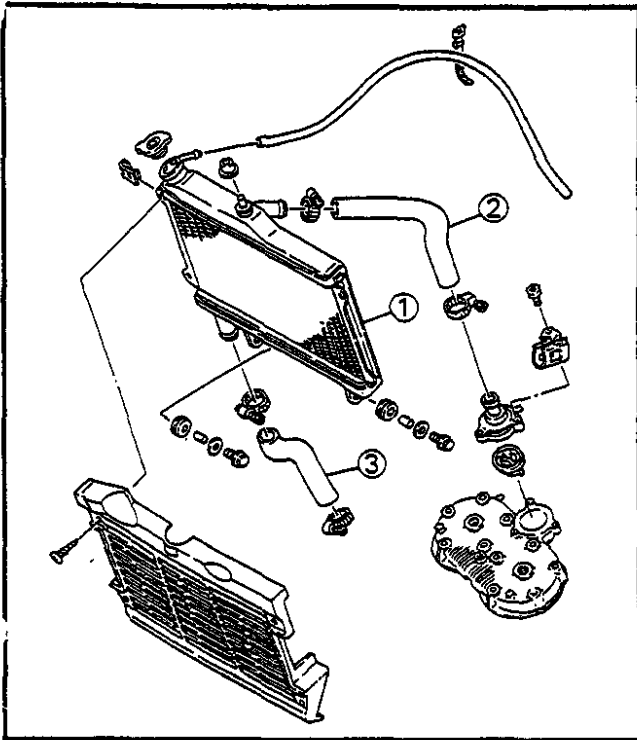

COOLING SYSTEM INSPECTION

1. Inspect:

- Radiator ①
 - Inlet hose ②
 - Outlet hose ③
- Cracks/Damage → Replace.

Refer to the "CHAPTER 5—COOLING SYSTEM" for replacement.

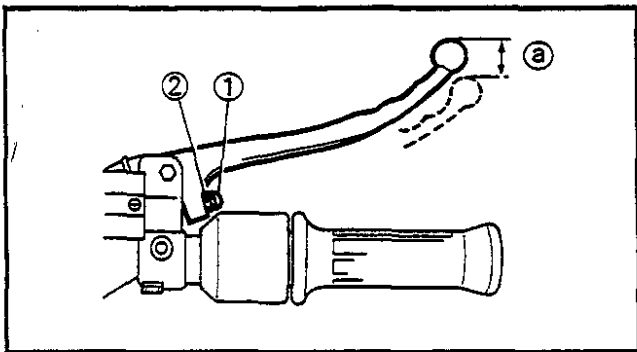

CHASSIS

FRONT BRAKE ADJUSTMENT

1. Check:

- Brake lever free play ①
- Out of specification → Adjust.

	Free Play:
	2–5 mm (0.08–0.20 in)

2. Adjust:

- Brake lever free play

Adjustment steps:	
•Loosen the locknut ②.	
•Turn the adjuster ① in or out until the specified free play is obtained.	
Turn in	Free play is decreased.
Turn out	Free play is increased.
•Tighten the locknut.	

CAUTION: _____

Proper lever free play is essential to avoid excessive brake drag.

REAR BRAKE ADJUSTMENT/ BRAKE FLUID INSPECTION

INSP	
ADJ	

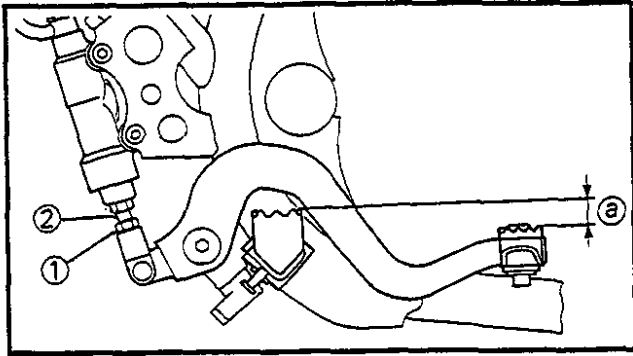

REAR BRAKE ADJUSTMENT

1. Check:
 - Brake pedal height **a**
 - Out of specification → Adjust.



Brake Pedal Height:
15 mm (0.6 in)
Below Top of Footrest.

2. Adjust:
 - Brake pedal height

Adjustment steps:

- Loosen the locknut **1**
- Turn the adjuster **2** in or out until the specified pedal height is obtained.

Turn in	Pedal height is increased.
---------	----------------------------

Turn out	Pedal height is decreased.
----------	----------------------------

WARNING:

After adjusting the brake pedal height, visually check the adjuster end. The adjuster end must appear within 3~5 mm (0.12~0.20 in).

- Tighten the locknut.



Locknut:
26 Nm (2.6 m•kg, 19 ft•lb)

CAUTION:

After adjusting the pedal height, make sure that the rear brake does not drag.

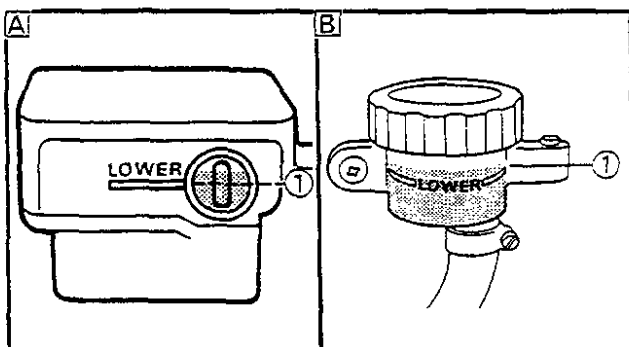
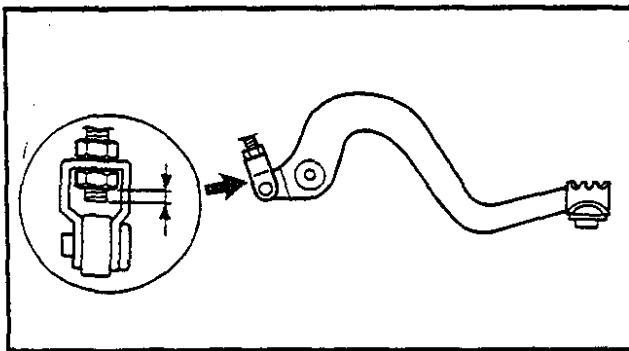

BRAKE FLUID INSPECTION

1. Place the motorcycle on a level surface.
2. Inspect:
 - Brake fluid level
 - Fluid level is under "LOWER" level line
 - 1** → Replenish.

- A** For front brake
- B** For rear brake



Recommended Brake Fluid:

DOT #4

If DOT #4 is not available, #3 can be used.

NOTE:

- Position the motorcycle straight up when inspecting the brake fluid level.
- When inspecting the front brake fluid level, make sure the master cylinder top is horizontal by turning the handlebars.

CAUTION:

Brake fluid may erode painted surfaces or plastic parts. Always clean up spilled fluid immediately.

WARNING:

- Use only the designated quality brake fluid; otherwise, the rubber seals may deteriorate, causing leakage and poor brake performance.
- Refill with the same type of brake fluid; mixing fluids may result in a harmful chemical reaction and lead to poor performance.
- Be careful that water does not enter the master cylinder when refilling. Water will significantly lower the boiling point of the fluid and may result in vapor lock.

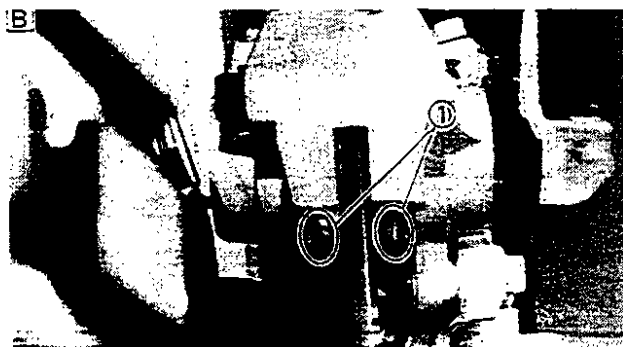
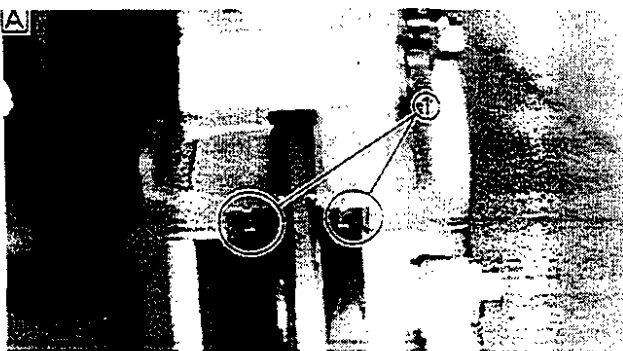

BRAKE PAD INSPECTION

1. Activate the brake lever or brake pedal.
2. Inspect:
 - Brake pad
Wear indicator ① almost contacts brake disc → Replace brake pad as a set.

- A** Front brake
- B** Rear brake

Refer to the "BRAKE PAD REPLACEMENT" section in the CHAPTER 7 for replacement.

BRAKE LIGHT SWITCH ADJUSTMENT/ BRAKE HOSE INSPECTION/AIR BLEEDING



BRAKE LIGHT SWITCH ADJUSTMENT

NOTE:

The brake light switch is operated by movement of the brake pedal.

Proper adjustment is achieved when the brake light comes on just before the brake begins to take effect.

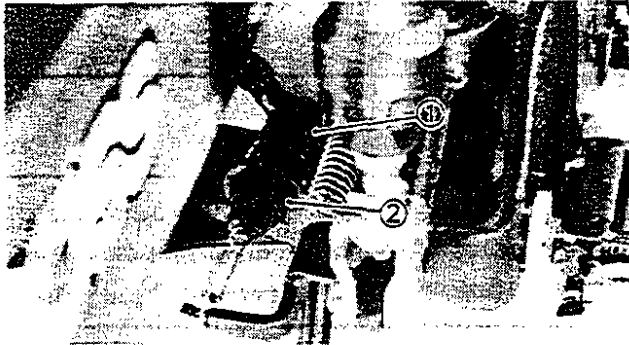

1. Hold the switch body ① with your hand so that it does not rotate and turn the adjusting nut ②.



BRAKE HOSE INSPECTION

1. Inspect:

- Brake hoses
 - Crack/Damage → Replace
- Refer to "FRONT AND REAR BRAKE" section in CHAPTER 6 for replacement.

- A** Front brake hose
B Rear brake hose

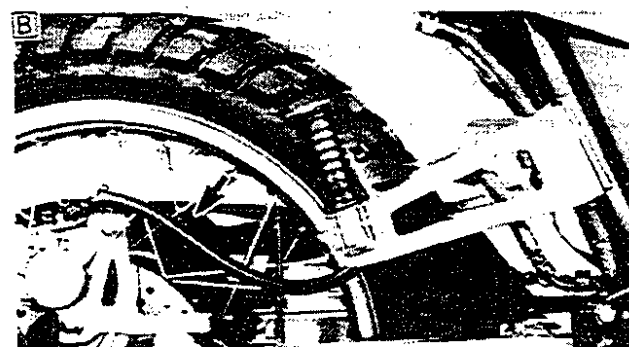

AIR BLEEDING

WARNING:

Bleed the brake system if:

- The system has been disassembled.
- A brake hose has been loosened or removed.
- The brake fluid is very low.
- The brake operation is faulty.

A dangerous loss of braking performance may occur if the brake system is not properly bled.

DRIVE CHAIN SLACK ADJUSTMENT

INSP
ADJ

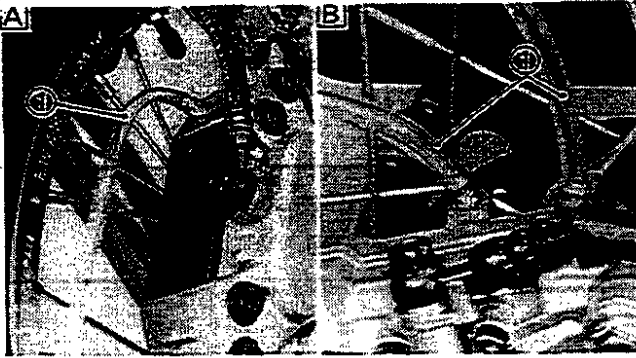

1. Bleed:
 - Brake system

Air bleeding steps:

- a. Add proper brake fluid to the reservoir.
- b. Install the diaphragm. Be careful not to spill any fluid or allow the reservoir to overflow.
- c. Connect the clear plastic tube ① tightly to the caliper bleed screw.

- A** Front
B Rear

- d. Place the other end of the tube into a container.
- e. Slowly apply the brake lever or pedal several times.
- f. Pull the lever in or push down on the pedal. Hold the lever or pedal in position.
- g. Loosen the bleed screw and allow the lever or pedal to travel towards its limit.
- h. Tighten the bleed screw when the lever or pedal limit has been reached; then release the lever or pedal.



Bleed Screw:

5 Nm (0.5 m•kg, 3.6 ft•lb)

- i. Repeat steps (e) to (h) until all of the air bubbles have been removed from the system.

NOTE:

If bleeding is difficult, it may be necessary to let the brake fluid system stabilize for a few hours. Repeat the bleeding procedure when the tiny bubbles in the system have disappeared.

- j. Add brake fluid to the level line on the reservoir.

DRIVE CHAIN SLACK ADJUSTMENT

NOTE:

Before checking and/or adjusting, rotate the rear wheel through several revolutions and check slack at several points to find the tightest point. Check and/or adjust the chain slack with the rear wheel in this "tightest" position.

DRIVE CHAIN SLACK ADJUSTMENT



1. Elevate the rear wheel by placing a suitable stand under the engine.

WARNING:

Securely support the motorcycle so there is no danger of it falling over.

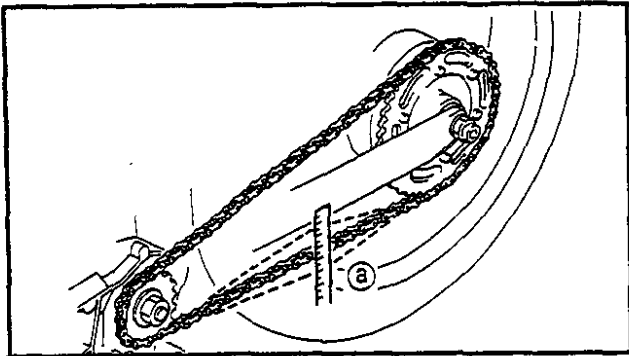

2. Check:
 - Drive chain slack (a)
 Out of specification → Adjust.

Drive Chain Slack:
20 ~ 30 mm (0.8 ~ 1.2 in)

3. Adjust:
 - Drive chain slack

Adjustment steps:

CAUTION:

Too small chain slack will overload the engine and other vital parts; keep the slack within the specified limits.

- Loosen the locknut ① and axle nut ②.
- Loosen the bolt ③ (Brake caliper bracket).
- Loosen the locknut ④ and turn the adjuster ⑤ in or out until the specified slack is obtained.

Turn in Slack is increased.

Turn out Slack is decreased.

NOTE:

Turn each adjuster exactly the same amount to maintain correct axle alignment. (There are marks on each side of swingarm and on each chain puller; use them to check for proper alignment.)

- Tighten the axle nut to specification, while pushing up or down the chain to be tight.

Wrench icon Axle Nut:
100 Nm (10.0 m•kg, 72 ft•lb)

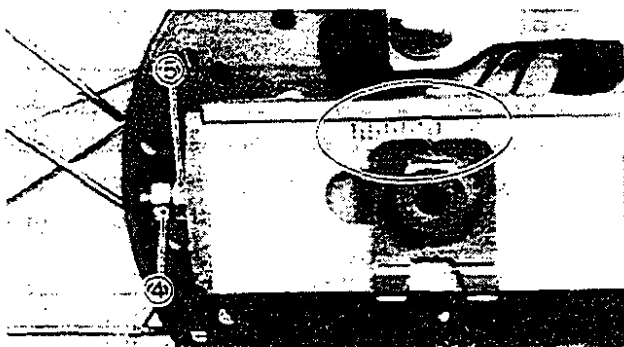
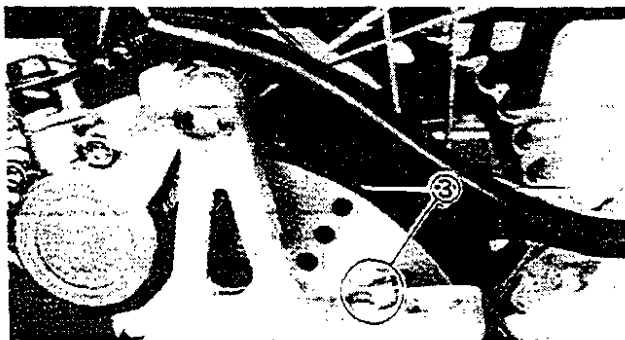
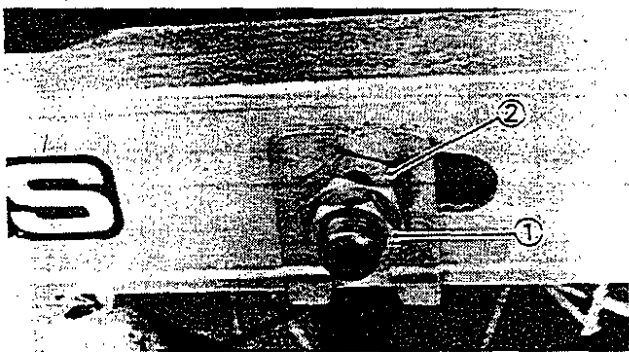

DRIVE CHAIN LUBRICATION/ STEERING HEAD ADJUSTMENT

INSP
ADJ



- Tighten the locknut (Chain adjuster), locknut (Axle nut) and bolt (Brake Caliper bracket).



Locknut (Axle Nut):

45 Nm (4.5 m•kg, 32 ft•lb)

Bolt (Brake Caliper Bracket):

45 Nm (4.5 m•kg, 32 ft•lb)

DRIVE CHAIN LUBRICATION

The chain consists of many parts which work against each other. If the chain is not maintained properly, it will wear out rapidly, therefore, form the habit of periodically servicing the chain. This service is especially necessary when riding in dusty conditions.

This motorcycle has a drive chain with small rubber O-rings between the chain plates. Steam cleaning, high-pressure washes, and certain solvents can damage these O-rings. Use only kerosene to clean the drive chain. Wipe it dry, and thoroughly lubricate it with SAE 30~50W motor oil. Do not use any other lubricants on the drive chain. They may contain solvents that could damage the O-rings.



Recommended Lubricant:

SAE 30~50 Motor Oil or Chain Lubricants Suitable for "O-ring" Chains

STEERING HEAD ADJUSTMENT

1. Elevate the front wheel by placing a suitable stand under the engine.

WARNING:

Securely support the motorcycle so there is no danger of it falling over.

2. Check:

- Steering assembly bearings

Grasp the bottom of the forks and gently rock the fork assembly back and forth.

Looseness → Adjust steering head.

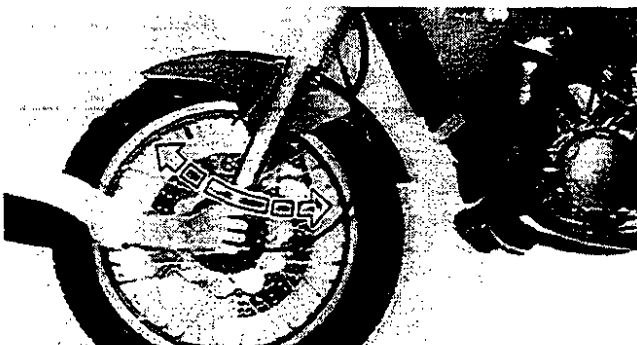

STEERING HEAD ADJUSTMENT

INSP	
ADJ	

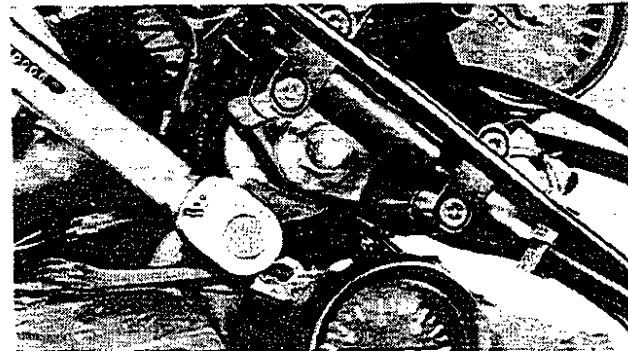
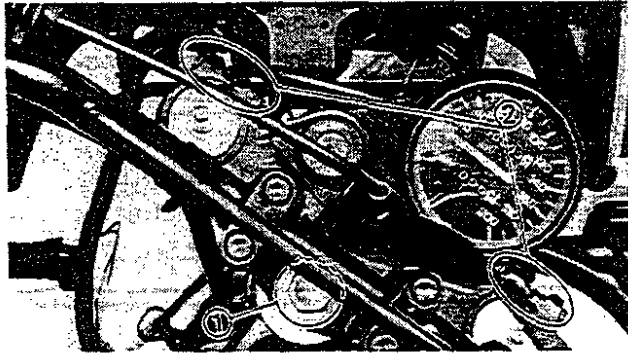

3. Adjust:
- Steering head

Adjustment steps:

- Remove the front wheel.
Refer to the "FRONT WHEEL" section in the CHAPTER 7.
- Remove the cowlings.
Refer to the "COWLINGS" section in the CHAPTER 3.
- Loosen the bolt ① (Steering shaft) and bolt ② (Handlebar crown).
- Tighten the ring nut using the Ring Nut Wrench.



Ring Nut Wrench:
90890-01403

NOTE: _____
Set the torque wrench to the ring nut wrench so that they form a right angle.



Ring Nut (Initial Tightening):
38 Nm (3.8 m•kg, 27 ft•lb)

- Loosen the ring nut one turn.
- Retighten the ring nut using the Ring Nut Wrench.

WARNING: _____
Avoid over-tightening.



Ring Nut (Final Tightening):
11 Nm (1.1 m•kg, 8.0 ft•lb)

NOTE: _____
Recheck the Steering head by turning the steering from lock to lock, after adjusting steering head.
If steering is binded, loosen the ring nut so that there is no free play on bearing.
If steering is loosend, repeat the adjustment steps.

FRONT FORK INSPECTION

INSP
ADJ



- Tighten the bolt (Steering shaft) and bolt (Handlebar crown).



Bolt (Steering Shaft):

70 Nm (7.0 m•kg, 50 ft•lb)

Bolt (Handlebar Crown):

25 Nm (2.5 m•kg, 18 ft•lb)

- Install the cowlings.
Refer to the "COWLINGS" section in the CHAPTER 3.
- Install the front wheel.
Refer to the "FRONT WHEEL" section in the CHAPTER 7.

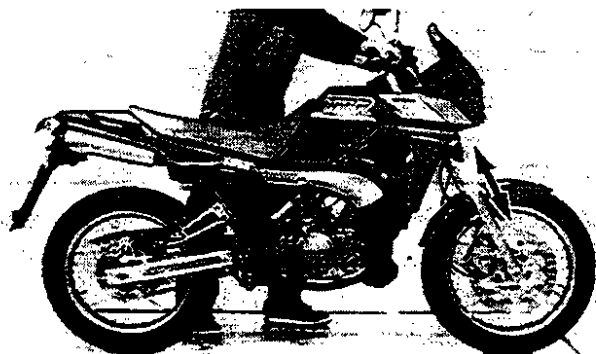

FRONT FORK INSPECTION

WARNING:

Securely support the motorcycle so there is no danger of it falling over.

1. Place the motorcycle on a level place.
2. Check:
 - Inner tube
Scratch/Damage → Replace.
 - Oil seal
Excessive oil leakage → Replace.
3. Hold the motorcycle on upright position and apply the front brake.
4. Check:
 - Operation
Pump the front fork up and down for several times.
Unsmooth operation → Repair.

FRONT FORK ADJUSTMENT



FRONT FORK ADJUSTMENT

WARNING:

Always adjust each fork to the same setting. Uneven adjustment can cause poor handling and loss of stability.

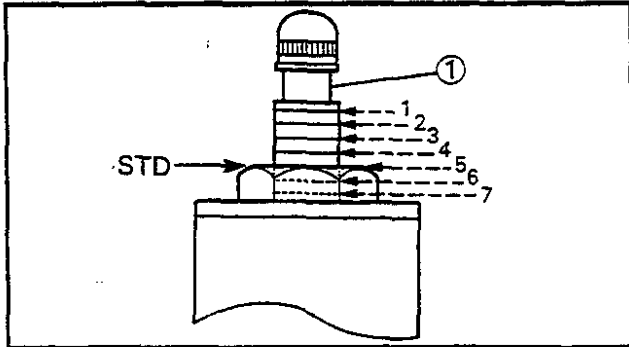

Spring Preload

- Adjust:
 - Spring preload

Adjustment steps:

- Turn the adjuster ① in or out.

Turn in	Preload is increased.
Turn out	Preload is decreased.

	Hard				STD	Soft	
Adjusting position	1	2	3	4	5	6	7

CAUTION:

The grooves are there just to show the adjusting level.

Air Pressure

- Elevate the front wheel by placing a suitable stand under the engine.

NOTE:

When checking and adjusting the air pressure, there should be no weight on the front end of the motorcycle.

WARNING:

Securely support the motorcycle so there is no danger of it falling over.

REAR SHOCK ABSORBER ADJUSTMENT

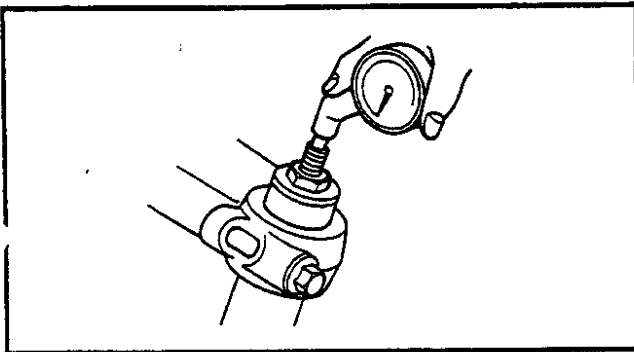
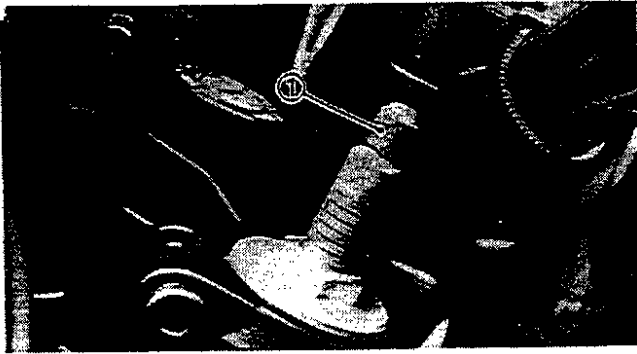

2. Remove:
 - Valve caps ①
3. Adjust:
 - Air pressure

Adjustment steps:

- Using the air check gauge, check and adjust the air pressure.

Stiffer→ Increase the air pressure.

(Use an air pump or pressurized air supply.)

Softer→ Decrease the air pressure.

(Release the air by pushing the valve.)

Standard Air Pressure:

Zero kPa (Zero kg/cm³, Zero psi)

Maximum Air Pressure:

40 kPa (0.4 kg/cm², 5.7 psi)

CAUTION:

Never exceed the maximum pressure, or oil seal damage may occur.

WARNING:

The difference between both the left and right tubes should be 10 kPa (0.1 kg/cm², 1.4 psi) or less.

4. Install:
 - Valve caps

REAR SHOCK ABSORBER ADJUSTMENT

The spring preload of the rear shock absorber can be adjusted to suit rider's preference, weight, and the course conditions.

REAR SHOCK ABSORBER ADJUSTMENT



1. Elevate the rear wheel by placing a suitable stand under the engine.

WARNING:

Securely support the motorcycle so there is no danger of it falling over.

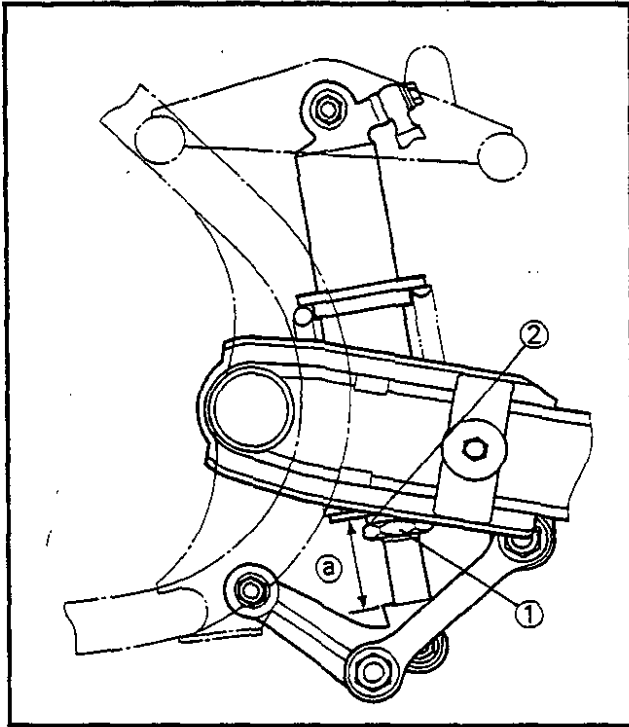

2. Adjust:
 - Spring preload

Adjustment steps:

- Loosen the locknut ①.
- Adjust the spring preload

NOTE:

The length of the spring (installed) changes 1.0 mm (0.04 in) per turn of the adjuster.

- Turn the adjuster ② in
→ Increase the spring preload.
- Turn the adjuster ② out
→ Decrease the spring preload.



Measurement Length ②:

- Minimum**
36.3 mm (1.43 in)
- Maximum**
45.3 mm (1.78 in)

CAUTION:

Never attempt to turn the adjuster beyond the maximum or minimum setting.

- Tighten the locknut.



- Locknut:**
55 Nm (5.5 m•kg, 40 ft•lb)

NOTE:

When adjusting, use the special wrench and extension bar which are included in the owner's tool kit.

RECOMMENDED COMBINATIONS OF FRONT FORK AND REAR SHOCK ABSORBER SETTINGS/ TIRE INSPECTION



RECOMMENDED COMBINATIONS OF FRONT FORK AND REAR SHOCK ABSORBER SETTINGS

Use this table as a guide for specific riding and motorcycle load conditions.

Front fork		Rear shock absorber	Loading condition			
Air pressure	Adjusting position	Measurement "A"	Solo rider	With passenger	With accessories equipment	With accessories equipment and passenger
0 kg/cm ² (0 psi)	5	36.3 mm (1.43 in)	○			
0 kg/cm ² (0 psi)	5	36.3 mm (1.43 in)		○		
0 kg/cm ² (0 psi)	5	36.3 mm (1.43 in)			○	
0 kg/cm ² (0 psi)	5-4	38.3-40.3 mm (1.51-1.59 in)				○

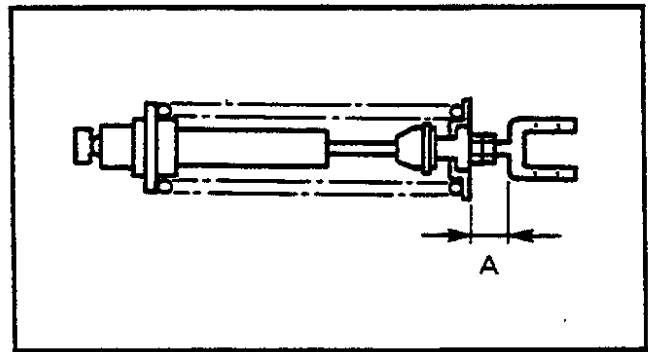
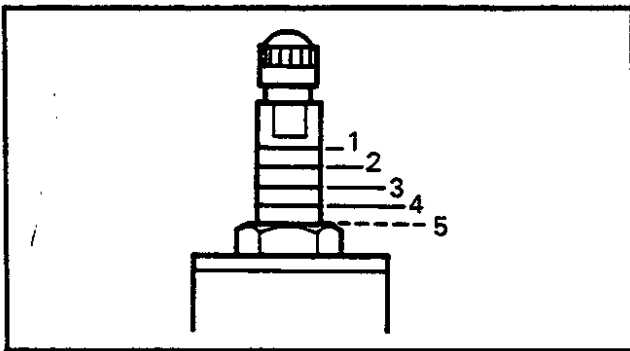

TIRE INSPECTION

1. Measure:

- Tire pressure

Out of specification → Adjust.

WARNING:

Tire inflation pressure should be checked and adjusted when the temperature of the tire equals the ambient air temperature. Tire inflation pressure must be adjusted according to total weight of cargo, rider, passenger, and accessories (fairing, saddlebags, etc. if approved for this model), and vehicle speed.



Basic weight: With oil and full fuel tank	153 kg (337 lb)	
Maximum load*	Front	Rear
	43 kg (91 lb)	157 kg (346 lb)
Cold tire pressure	Front	Rear
	Up to 90 kg (198 lb) load*	180 kPa (1.8 kg/cm ² , 26 psi)
90 kg (198 lb) ~ Maximum load*	200 kPa (2.0 kg/cm ² , 28 psi)	230 kPa (2.3 kg/cm ² , 32 psi)
High speed riding	200 kPa (2.0 kg/cm ² , 28 psi)	230 kPa (2.3 kg/cm ² , 32 psi)

*Load is the total weight of cargo, rider, passenger, and accessories.

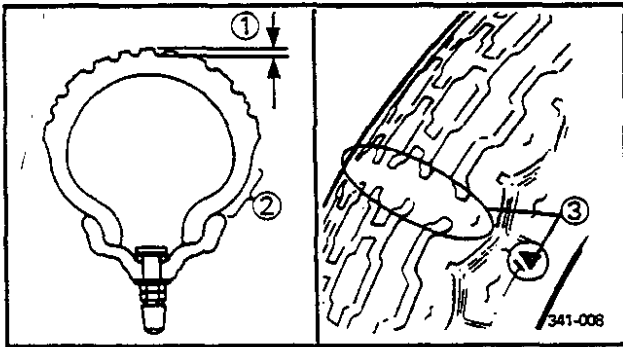

2. Inspect:

- Tire surfaces
- Wear/Damage → Replace.

Minimum Tire Tread Depth:
(Front and Rear)
1.0 mm (0.04 in)

- ① Tread depth
- ② Side wall
- ③ Wear indicator

WARNING:

- After mounting a tire, ride conservatively to allow proper tire to rim seating. Failure to do so may cause an accident resulting in motorcycle damage and possible operator injury.
- After a tire repair or replacement, be sure to torque/tighten the valve stem locknut ① to specification.

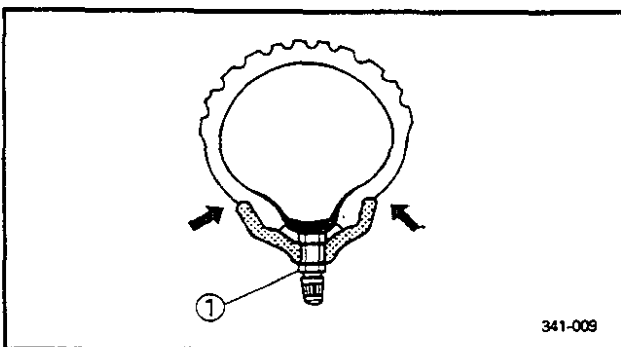

Valve-stem Locknut:
1.5 Nm (0.15 m•kg, 1.1 ft•lb)



WARNING:

After extensive tests, the tires mentioned below have been approved by Yamaha motor Co., Ltd. for this model. No guarantee for handling characteristics can be given if tire combinations other than what is approved are used on this motorcycle. The front and rear tires should be of the same manufacture and design.

FRONT:

Manufacture	Size	Type
Bridgestone	100/90-18 56H	TW35
Metzeler	100/90-18 56H	ENDURO 3 SAHARA

REAR:

Manufacture	Size	Type
Bridgestone	120/80-17 61H	TW36
Metzeler	120/80-17 61H	ENDURO 3 SAHARA

WARNING:

- It is dangerous to ride with a wornout tire. When a tire tread begins to show lines, replace the tire immediately.
- Patching a punctured tube is not recommended. If it is absolutely necessary to do so, use great care and replace the tube as soon as possible with a good quality replacement.
- Do not attempt to use tubeless tires on a wheel designed for tube type tires only. Tire failure and personal injury may result from sudden deflation.

Wheel	Tire
Tube type	Tube type only
Tubeless	Tube type or tubeless

Be sure to install the correct tube when using tube type tires.

WHEEL INSPECTION / SPOKES INSPECTION AND TIGHTENING



WHEEL INSPECTION

1. Inspect:

- Wheels

Damage/Bends → Replace.

NOTE:

Always balance the wheel when a tire or wheel has been changed or replaced.

WARNING:

Never attempt even small repairs to the wheel.

2. Tighten:

- Valve stem locknut



1.5 Nm (0.15 m•kg, 1.1 ft•lb)

WARNING:

Ride conservatively after installing a tire to allow it to seat itself properly on the rim.

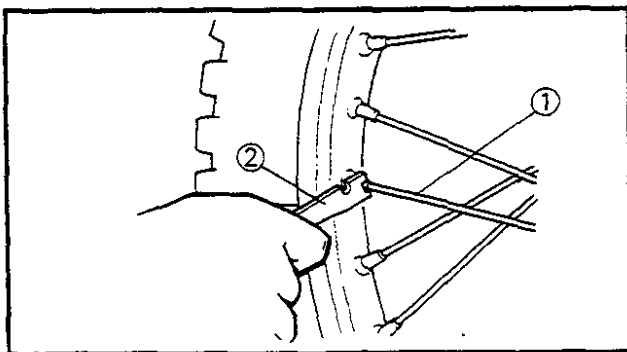

SPOKES INSPECTION AND TIGHTENING

1. Inspect:

- Spokes ①

Bend/Damage → Replace.

Loose spoke → Retighten.

2. Tighten:

- Spokes

- ② Spoke wrench

NOTE:

Be sure to retighten these spokes before and after Break-in.

After a practice or a race check spokes for looseness.



Nipple:

2 Nm (0.2 m•kg, 1.4 ft•lb)

CABLE INSPECTION AND LUBRICATION

WARNING:

Damaged cable sheath may cause corrosion and interfere with the cable movement. An unsafe condition may result so replace such cable as soon as possible.

1. Inspect:

- Cable sheath
Damage → Replace.

2. Check:

- Cable operation
Unsmooth operation → Lubricate.

	Recommended Lubricant: SAE 10W30 Motor Oil
---	---

NOTE:

Hold cable end high and apply several drops of lubricant to cable.

LEVER AND PEDAL LUBRICATION

Lubricate pivoting parts of each lever and pedal.

	Recommended Lubricant: SAE 10W30 Motor Oil
---	---

SIDESTAND LUBRICATION

Lubricate the sidestand at pivot points.

	Recommended Lubricant: SAE 10W30 Motor Oil
---	---



ELECTRICAL BATTERY INSPECTION

1. Remove:
 - Seat
 - Side cover (Right)
 Refer to "SIDE COVERS" section in CHAPTER 3.

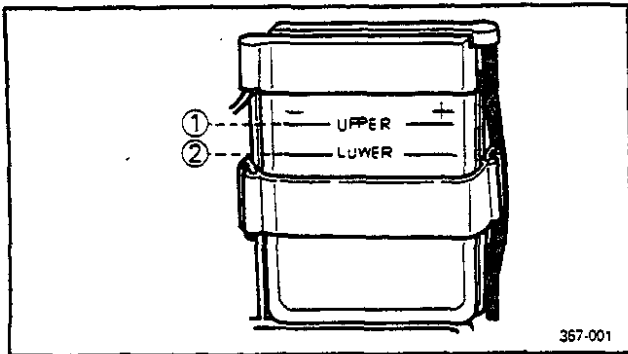

2. Inspect:
 - Fluid level should be between upper ① and lower ② level marks.
 - Incorrect → Refill.

CAUTION:

Refill with distilled water only; tap water contains minerals harmful to a battery.

3. Inspect:
 - Battery terminal
 - Dirty terminal → Clean with wire brush.
 - Poor connection → Correct.

NOTE:

After cleaning the terminals, apply grease lightly to the terminals.

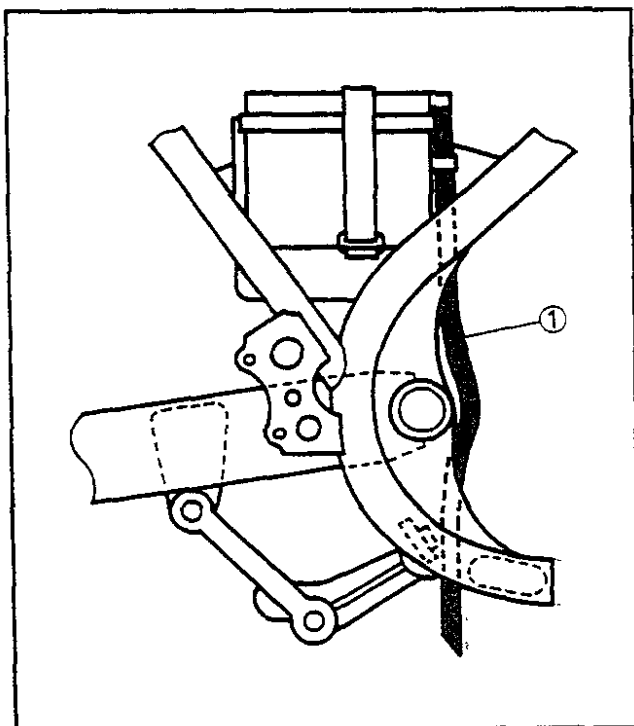

4. Connect:
 - Breather pipe ①
 - Be sure the hose is properly attached and routed.

5. Inspect:
 - Breather pipe
 - Obstruction → Remove.
 - Damage → Replace.

CAUTION:

When inspecting the battery, be sure the breather pipe is routed correctly. If the breather pipe touches the frame or exits in such a way as to cause battery electrolyte or gas to exit onto the frame, structural and cosmetic damage to the motorcycle can occur.

BATTERY INSPECTION

INSP
ADJ

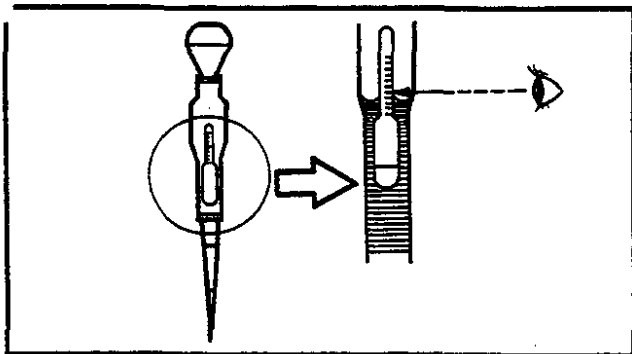

6. Check:

- Specific gravity

Less than 1.280 → Recharge battery.

Charging Current:

0.4 amps/10 hrs

Specific Gravity:

1.280 at 20°C (68°F)

Replace the battery if:

- Battery voltage will not rise to a specific value or bubbles fail to rise even after many hours of charging.
- Sulfation of one or more cells occurs, as indicated by the plates turning white, or an accumulation of material exists in the bottom of the cell.
- Specific gravity readings after a long, slow charge indicate one cell to be lower than the rest.
- Warpage or buckling of plates or insulators is evident.

CAUTION:

Always charge a new battery before using it to ensure maximum performance.

**WARNING:**

Battery electrolyte is dangerous; it contains sulfuric acid and therefore is poisonous and highly caustic.

Always follow these preventive measures:

- Avoid bodily contact with electrolyte as it can cause severe burns or permanent eye injury.
- Wear protective eye gear when handling or working near batteries.

Antidote (EXTERNAL):

- SKIN—Flush with water.
- EYES—Flush with water for 15 minutes and get immediate medical attention.

Antidote (INTERNAL):

- Drink large quantities of water or milk followed with milk of magnesia, beaten egg, or vegetable oil. Get immediate medical attention.

Batteries also generate explosive hydrogen gas, therefore you should always follow these preventive measures:

- Charge batteries in a well-ventilated area.
- Keep batteries away from fire, sparks, or open flames (e.g., welding equipment, lighted cigarettes, etc.)
- **DO NOT SMOKE** When charging or handling batteries.

KEEP BATTERIES AND ELECTROLYTE OUT OF REACH OF CHILDREN.

7. Install:

- Side cover (Right)
- Seat

Refer to "SIDE COVERS" section in CHAPTER 3.

CIRCUIT BREAKER INSPECTION

1. Remove:

- Seat
- Side cover (Right)

Refer to "SIDE COVERS" section in CHAPTER 3.

CIRCUIT BREAKER INSPECTION



- 2. Disconnect:
 - Circuit breaker leads

- 3. Inspect:
 - Circuit breaker

Inspection steps: <ul style="list-style-type: none">•Push in the circuit breaker.•Connect the Pocket Tester to the circuit breaker leads and check it for continuity. NOTE: _____ Set the tester selector to " $\Omega \times 1$ " position. _____	
	Pocket Tester: 90890-03112
•If the tester is indicated at ∞ . The circuit breaker is faulty, replace it.	

- 4. Replace:
 - Circuit breaker

Replacement steps: <ul style="list-style-type: none">•Turn off the main switch.•Install a new circuit breaker or proper amperage.
Circuit Breaker Capacity: 20 A
WARNING: _____ Do not use circuit breaker of higher amperage rating than recommended. Extensive electrical system damage and fire could result from substitution of a circuit breaker of improper amperage. _____

- 5. Inspect:
 - Electrical circuit

Inspection steps: <ul style="list-style-type: none">•Push in the circuit breaker.•Turn on switches to verify operation of electrical device.•If the circuit breaker interrupts the circuit again, check circuit in question.

HEADLIGHT BEAM ADJUSTMENT/ HEADLIGHT BULB REPLACEMENT

**INSP
ADJ**



CAUTION:

Wait 30 seconds before resetting the circuit breaker.

6. Install:

- Side cover (Right)
- Seat

Refer to "SIDE COVERS" section in CHAPTER 3.

HEADLIGHT BEAM ADJUSTMENT

1. Adjust:

- Headlight beam (Vertical)

To raise the beam	Turn the adjuster ① clockwise.
To lower the beam	Turn the adjuster ① counterclockwise.

2. Adjust:

- Headlight beam (Horizontal)

To right the beam	Turn the adjuster ② counterclockwise.
To left the beam	Turn the adjuster ② clockwise.

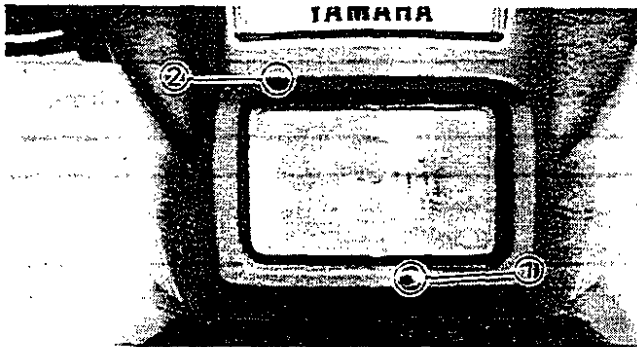

HEADLIGHT BULB REPLACEMENT

1. Disconnect:

- Headlight lead coupler ①

2. Remove:

- Cover ②

3. Remove:

- Bulb holder ①
- Bulb

NOTE:

Turn the bulb holder counterclockwise and remove the defective bulb.

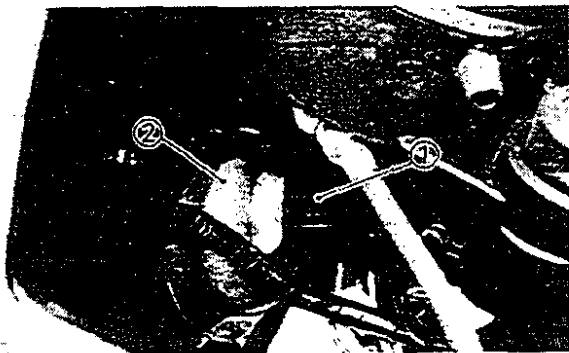

HEADLIGHT BULB REPLACEMENT



WARNING:

Keep flammable products or your hands away from the bulb while it is on, it will be hot. Do not touch the bulb until it cools down.

4. Install:

- Bulb (New)

Secure the new bulb with the bulb holder.

CAUTION:

Avoid touching glass part of bulb. Also keep it free from oil otherwise, transparency of glass, bulb life and illuminous flux will be adversely affected. If oil gets on bulb, clean it with a cloth moistened thoroughly with alcohol or lacquer thinner.

5. Install:

- Cover

6. Connect:

- Headlight lead coupler



ENGINE OVERHAUL

ENGINE REMOVAL

NOTE: _____

It is not necessary to remove the engine in order to remove the following components:

- Cylinder head
 - Cylinder
 - Piston and piston ring
 - Power valve
 - Clutch
 - Primary drive gear
 - Kick axle
 - Shift shaft
 - AC magneto
 - Autolube pump
 - Oil pump
-

COWLINGS

1. Remove:

- Lower cowl (Right)
- Lower cowl (Left)

Refer to "COWLINGS" section in CHAPTER 3.

SEAT AND SIDE COVERS

1. Remove:

- Seat
- Side covers

Refer to "SIDE COVERS" section in CHAPTER 3.

TRANSMISSION OIL

1. Drain:

- Transmission oil

Refer to "TRANSMISSION OIL REPLACEMENT" section in CHAPTER 3.

COOLANT

1. Drain:

- Coolant

Refer to "COOLANT REPLACEMENT" section in CHAPTER 3.

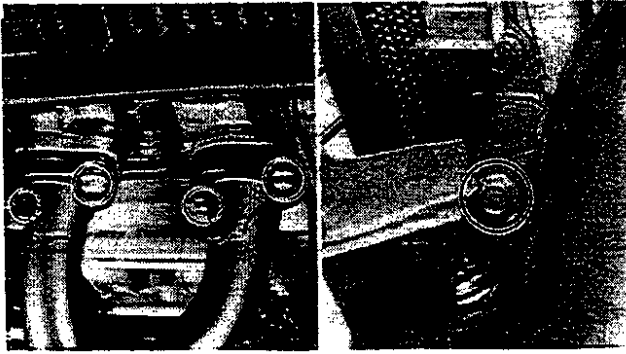

MUFFLER ASSEMBLY

1. Remove:
 - Muffler assembly

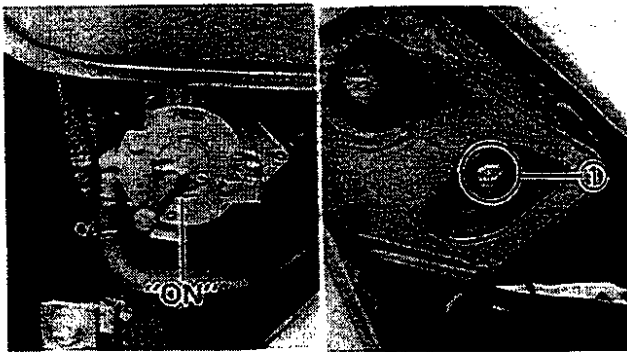
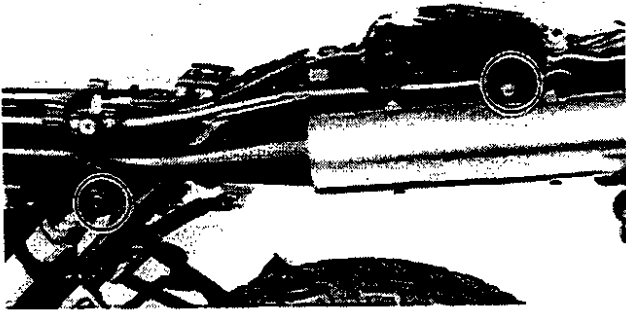

FUEL TANK (WITH OIL TANK)

1. Turn the fuel cock to "ON" position.

2. Remove:
 - Bolt ① (Fuel tank)

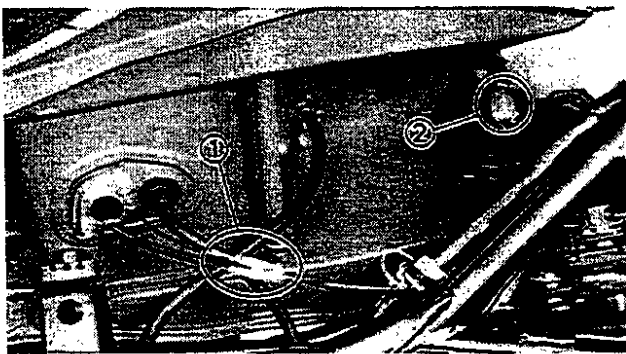

3. Disconnect:
 - Oil level gauge leads ①
 - Tachometer leads ②

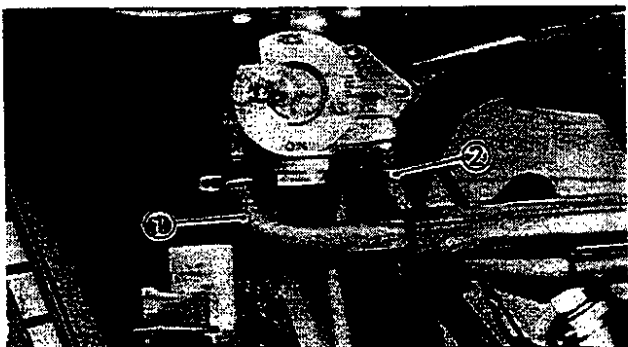

4. Disconnect:
 - Fuel hose ①
 - Vacuum hose ②

ENGINE REMOVAL

ENG

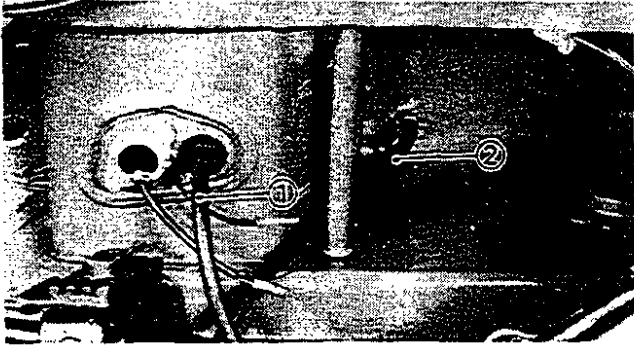

5. Disconnect:

- Oil hose ①
- Overflow hose ②

NOTE:

Plug the oil hose so that the oil will not run out of the oil tank.

6. Remove:

- Fuel tank

CARBURETOR

1. Remove:

- Carburetor

Refer to "CARBURETOR—REMOVAL" section in CHAPTER 6.

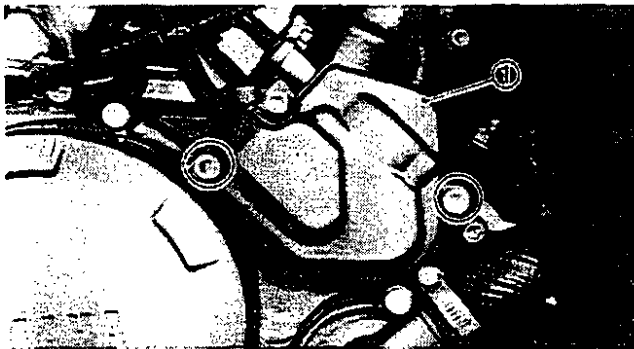

AUTOLUBE PUMP CABLE AND HOSE

1. Remove:

- Autolube pump cover ①



2. Remove:

- Clip ①
- Cable end ②

NOTE:

Turn the pump pulley counterclockwise by finger to make the pump cable loose enough for its end to be removed from the pulley.



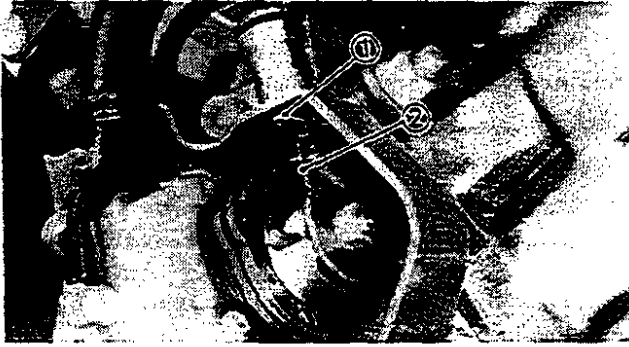

3. Remove:
 - Clip ①
 - Autolube pump cable ②

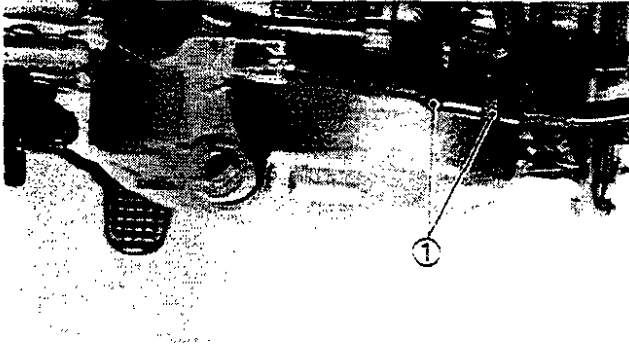

CLUTCH CABLE

1. Loosen:
 - Cable adjusters ①

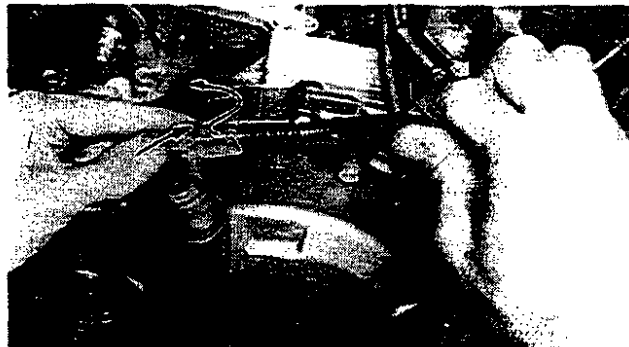

2. Remove:
 - Clutch cable

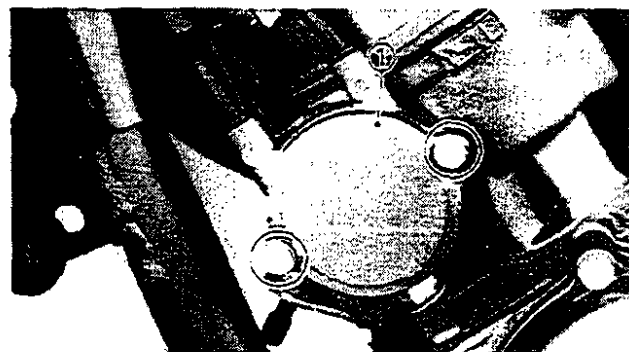

YPVS CABLES

1. Remove:
 - Pulley cover ① (Power valve)

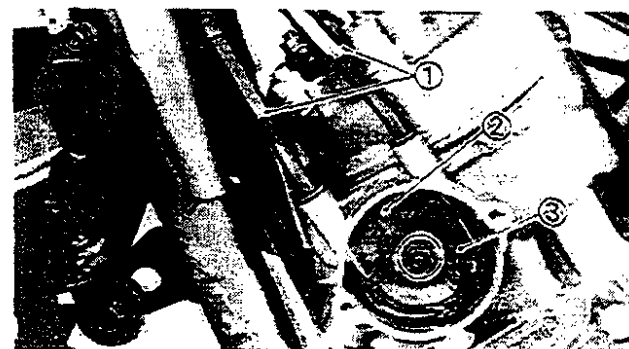

2. Loosen:
 - Cable adjusters ①
3. Insert a pin ② through the aligning indent in the pulley and into the hole.
4. Remove:
 - Pulley ③

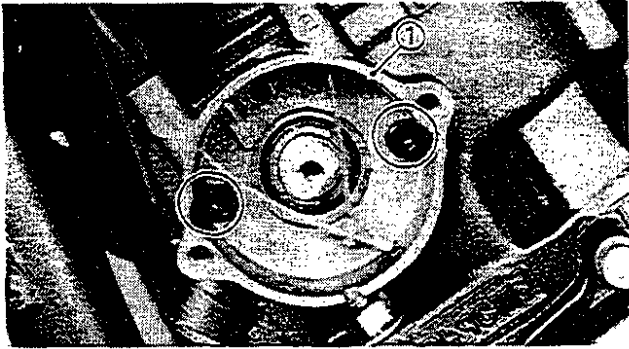

5. Remove:
•Pulley housing ①

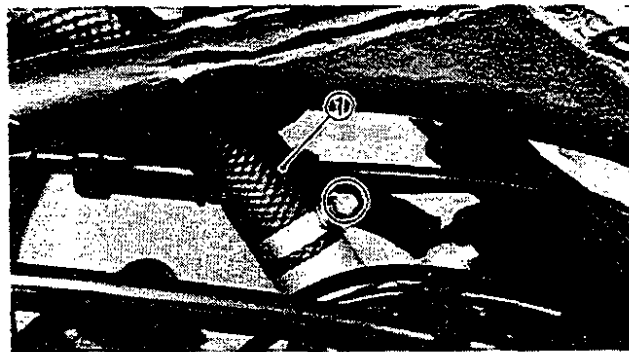

RADIATOR

1. Disconnect:
•Inlet hose ①

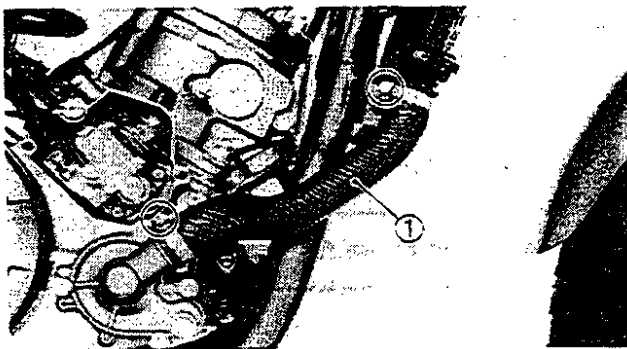

2. Disconnect:
•Outlet hose ①

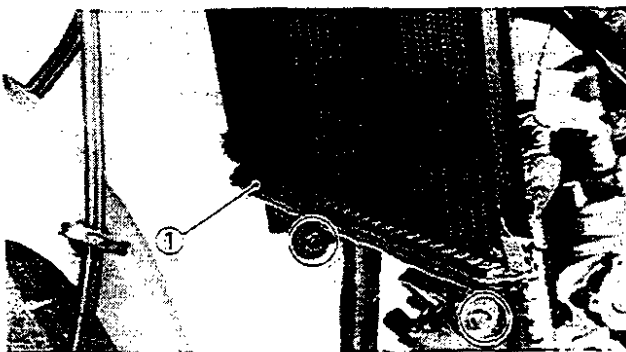

3. Remove:
•Radiator ①

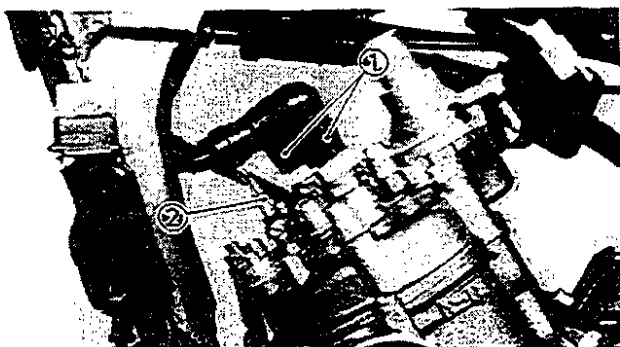

LEADS

1. Disconnect:
•Spark plug leads ①
•Thermo unit lead ②

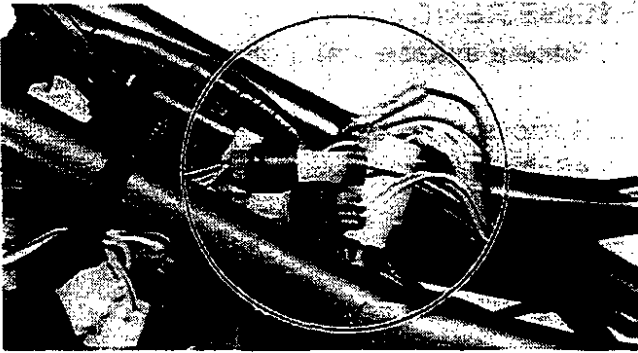

2. Disconnect:

- Stator coil leads
- Pickup coil leads
- Source coil leads

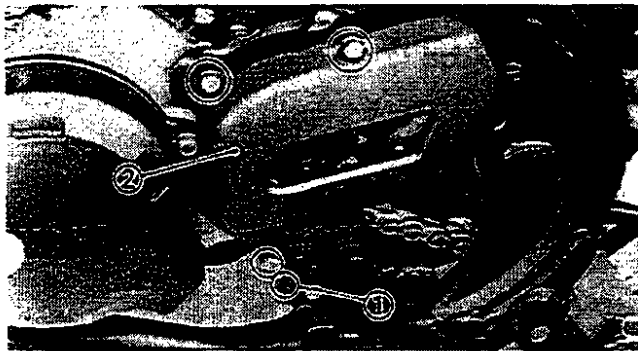

DRIVE CHAIN

1. Remove:

- Bolt ① (Shift arm)
- Crankcase cover ② (Left)



2. Straighten:

- Lock washer tab

3. Loosen:

- Nut ① (Drive sprocket)

NOTE:

Apply the rear brake for loosening the nut.

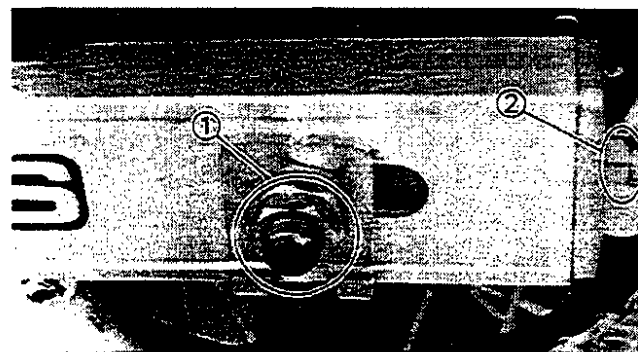

4. Loosen:

- Rear axle nut ①
- Adjusters ② (Chain puller)

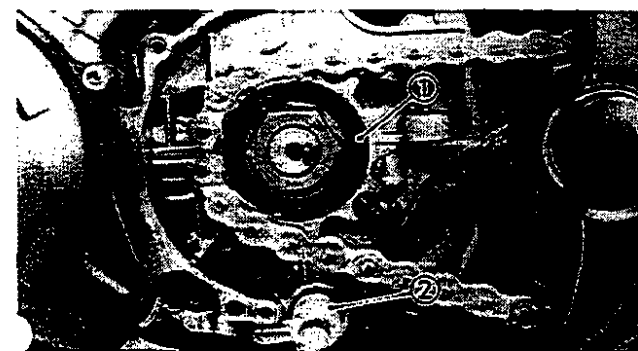

5. Remove:

- Drive sprocket ①
- Collar ②

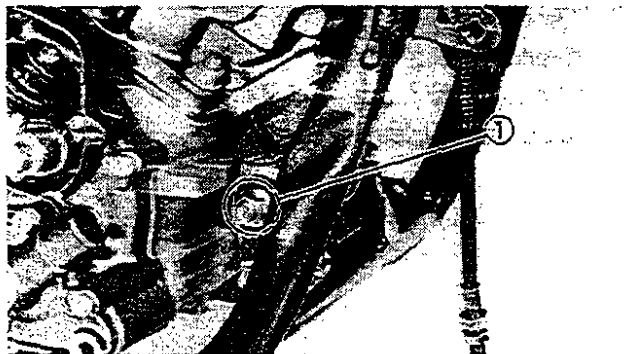

ENGINE REMOVAL

1. Place a suitable stand under the engine.

2. Remove:

- Bolts ① (Front)

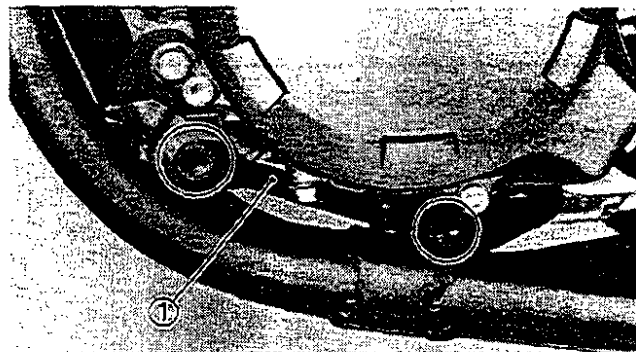

3. Remove:

- Torque rod ①

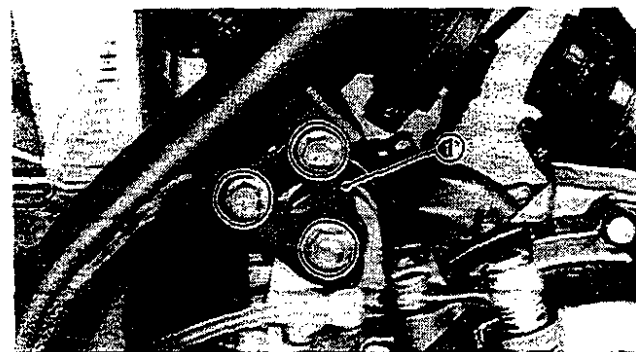

4. Remove:

- Engine stay ① (Rear)

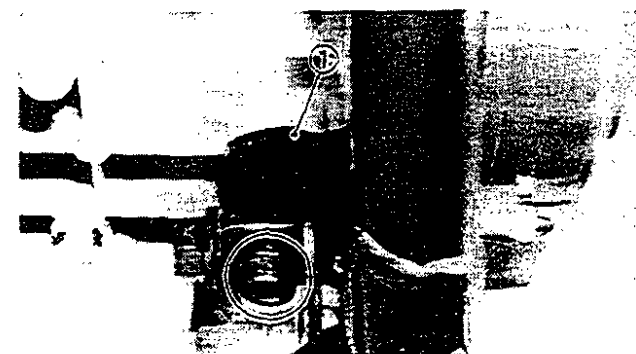

5. Remove:

- Torque rod stay ①



6. Remove:

- Engine assembly
To the right.



ENGINE DISASSEMBLY

CYLINDER HEAD, CYLINDERS AND PISTONS

NOTE:

With the engine mounted, the cylinder head, cylinders and pistons can be maintained by removing the following parts.

- Lower cowlings
- Mufflers
- YPVS cables
- Radiator

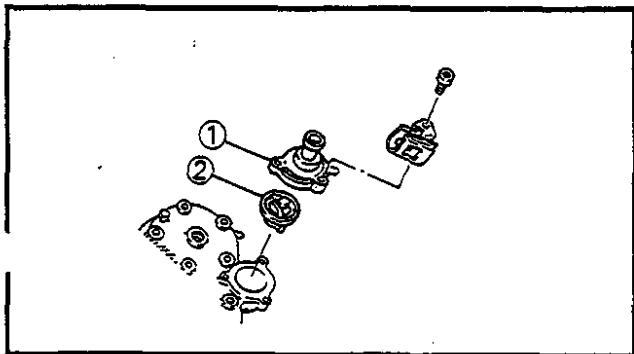

1. Remove:

- Thermostat cover ①
- Thermostat ②

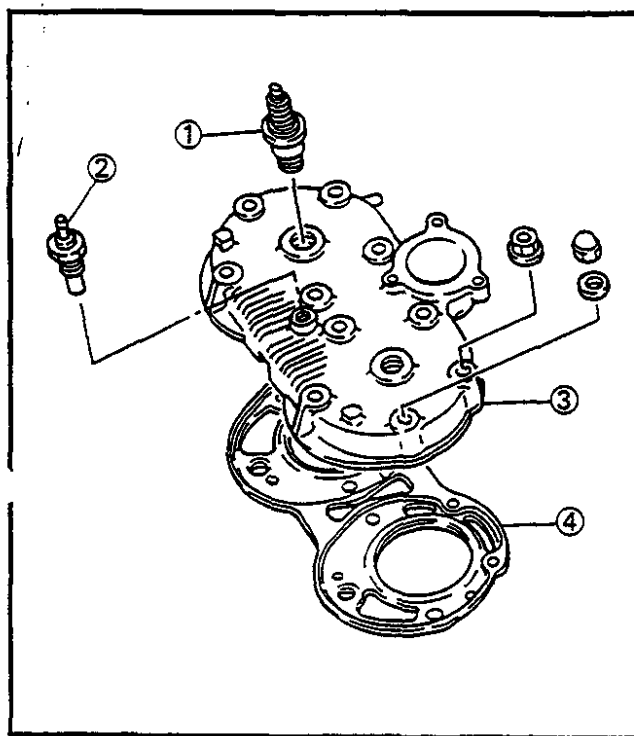

2. Remove:

- Spark plug ①
- Thermo unit ②
- Cylinder head ③
- Gasket ④ (Cylinder head)

NOTE:

- Loosen the nuts starting with the highest numbered one.
- Loosen the each nut 1/4 turn, and remove them after all nuts are loosened.

WARNING:

Handle the thermo-unit with special care. Never subject it to strong or allow it to be dropped. Should it be dropped, it must be replaced.

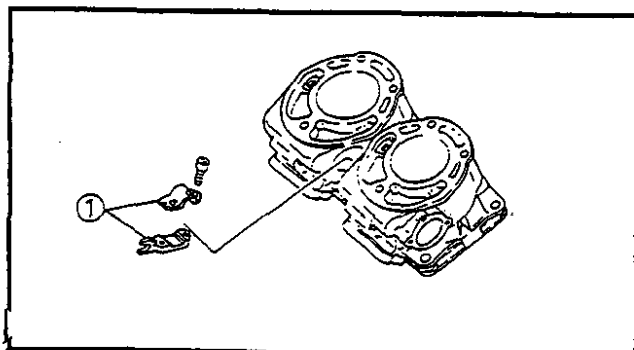

3. Remove:

- Joint ① (Power valve)

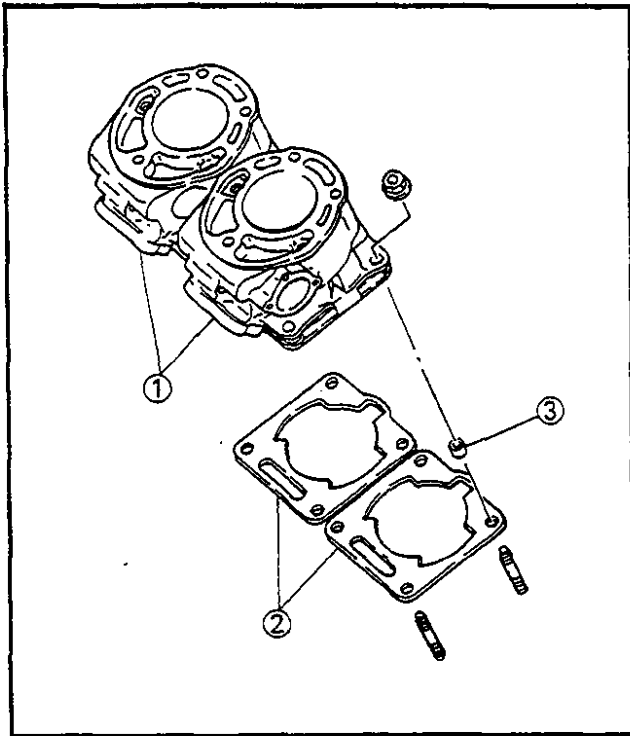

4. Remove:

- Cylinder ①
- Gasket ② (Cylinder)
- Dowel pin ③

NOTE:

Loosen each nut 1/4 turn, and remove them after all nuts are loosened.

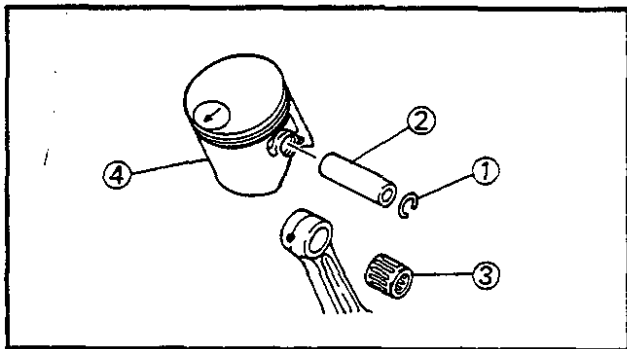

5. Remove:

- Piston pin clip ①
- Piston pin ②
- Small end bearing ③
- Piston ④

NOTE:

- Before removing piston pin circlip, cover crankcase with a clean rag to prevent circlip from falling into crankcase cavity.
- Before removing the piston pin, deburr the clip grooved and pin hole area. If the piston pin groove is deburred and piston pin is still difficult to remove, use Piston Pin Puller.



Piston Pin Puller:
90890-01304

CAUTION:

Do not use a hammer to drive the piston pin out.



CLUTCH

NOTE:

With the engine mounted, the clutch can be maintained by removing the following parts.

- Outlet hose
- Autolube pump cable and hose

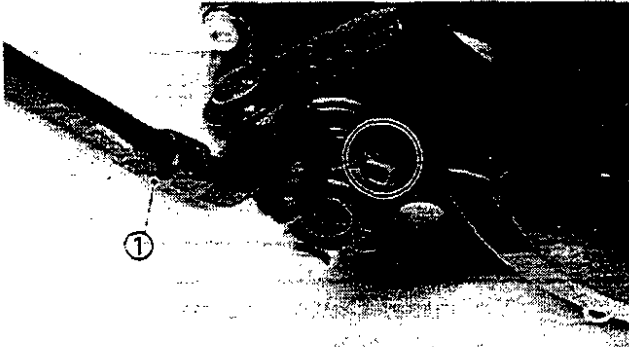

1. Remove:
 - Kick crank ①

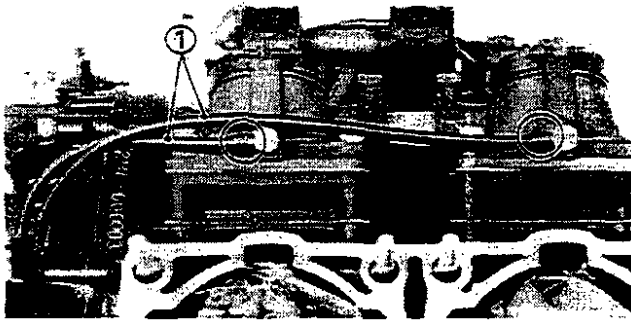

2. Disconnect:
 - Oil delivery hoses ①

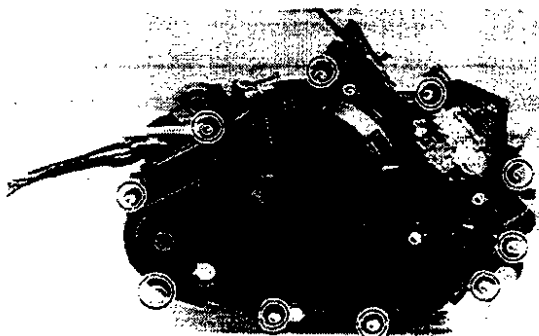

3. Remove:
 - Crankcase cover (Right)
 - Dowel pins
 - Gasket (Crankcase cover)

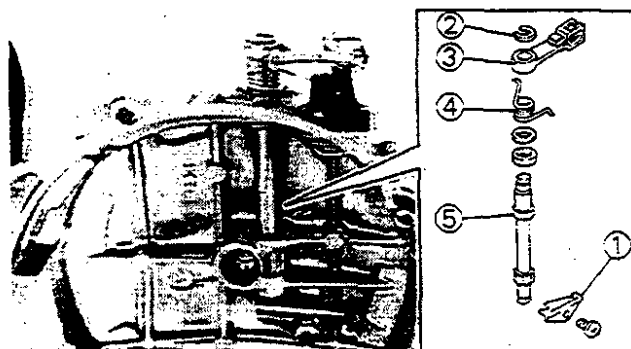

4. Remove:
 - Holder ① (Pull rod)
 - Circlip ②
 - Pull rod lever ③
 - Spring ④
 - Pull rod ⑤

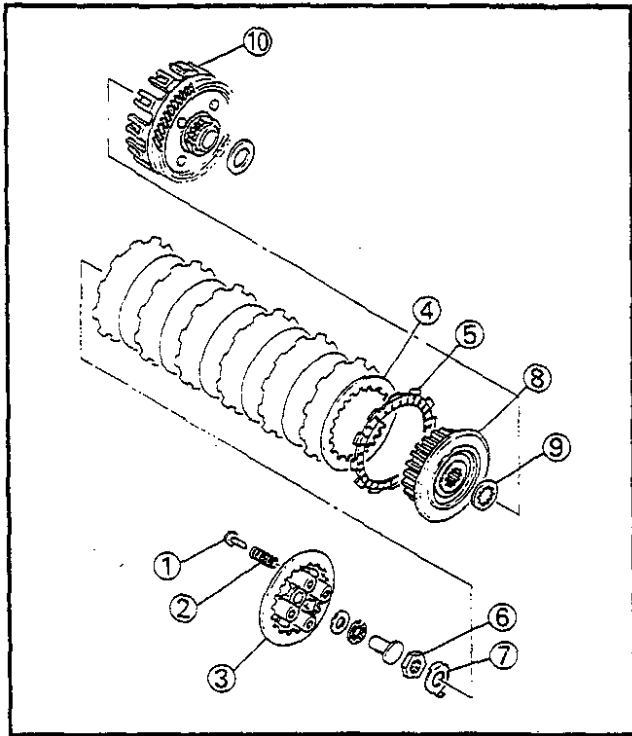

5. Remove:

- Bolt ① (Pressure plate)
- Clutch spring ②
- Pressure plate ③
- Clutch plate ④
- Friction plate ⑤
- Nut ⑥ (Clutch boss)
- Lock washer ⑦
- Clutch boss ⑧
- Thrust washer ⑨
- Clutch housing ⑩

NOTE:

- Before removing the nut (Clutch boss), straighten the lock washer tab.
- Hold the clutch boss to loosen the nut (Clutch boss) by the Universal Clutch Holder ⑪.



Universal Clutch Holder:
90890-04086

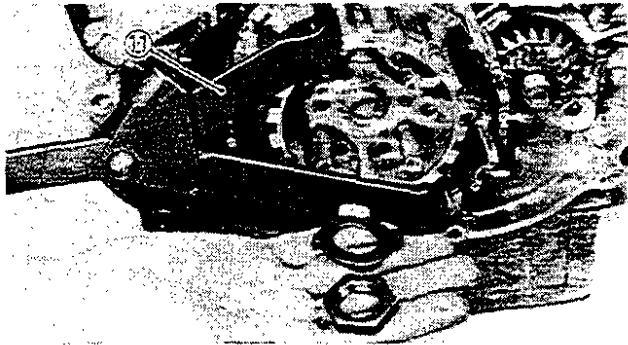

PRIMARY DRIVE GEAR

NOTE:

With the engine mounted, the primary drive gear can be maintained by removing the following parts.

- Kick crank
- Crankcase cover (Right)
- Clutch

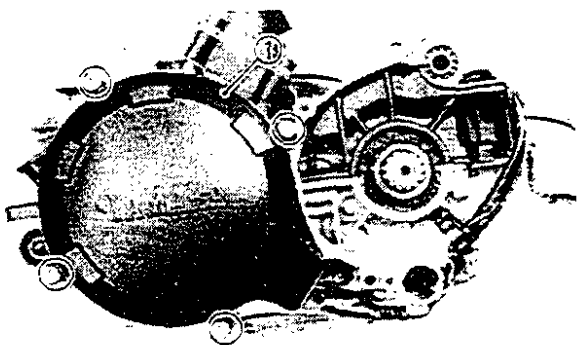

1. Remove:

- CDI magneto cover ①

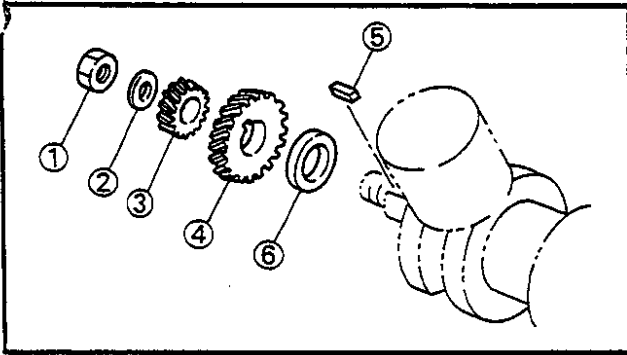

2. Remove:

- Nut ① (Primary drive gear)
- Conical spring washer ②
- Drive gear ③ (Water pump)
- Primary drive gear ④
- Key ⑤
- Spacer ⑥

NOTE:

Hold the rotor to loosen the nut (Primary drive gear) by the Universal Rotor Holder ⑦.

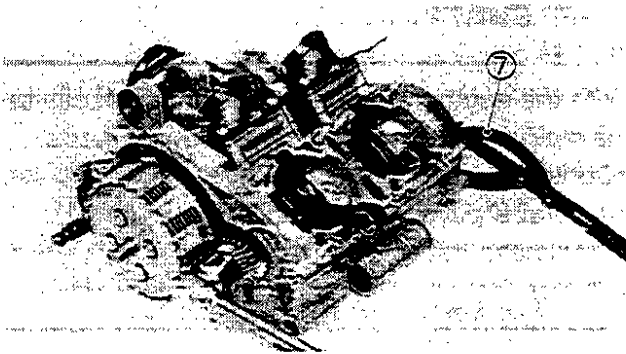

Universal Rotor Holder:
90890-01235

KICK AXLE AND KICK IDLE GEAR

NOTE:

With the engine mounted, the kick axle and kick idle gear can be maintained by removing the following parts.

- Outlet hose
- Autolube pump cable and hose
- Crankcase cover (Right)
- Clutch

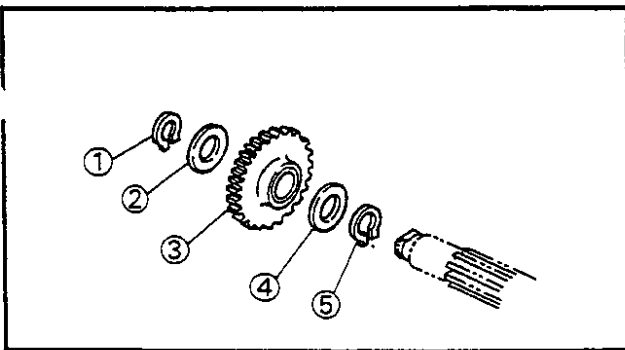

1. Remove:

- Circlip ①
- Plain washer ②
- Kick idle gear ③
- Plain washer ④
- Circlip ⑤

2. Remove:

- Thrust washer ① (Clutch housing)



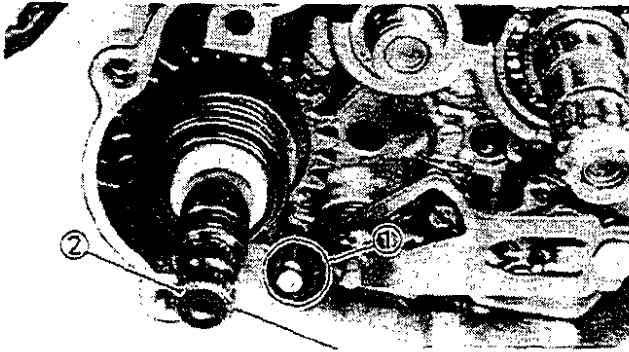

3. Unhook:
 - Return spring ①
4. Remove:
 - Kick axle ②

SHIFT SHAFT

NOTE:

With the engine mounted, the shift shaft can be maintained by removing the following parts.

- Outlet hose
- Autolube pump cable and hose
- Crankcase cover (Right)
- Clutch

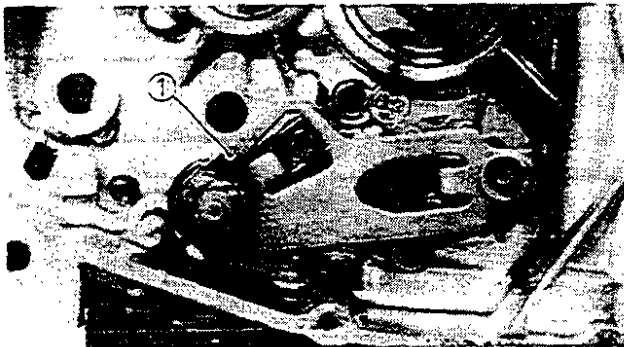

1. Remove:
 - Shift shaft ①

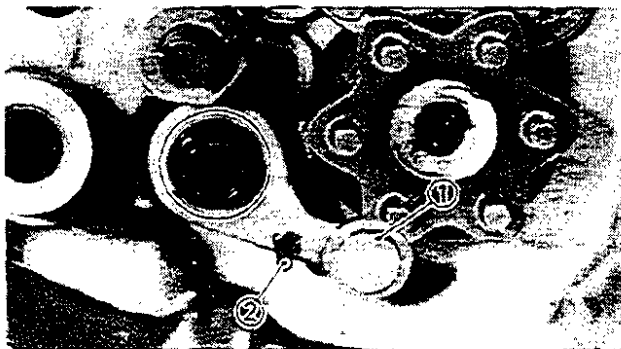

2. Remove:
 - Stopper lever ①
 - Return spring ②

CDI MAGNETO

NOTE:

With the engine mounted, the CDI magneto can be maintained by removing the following parts.

- Seat

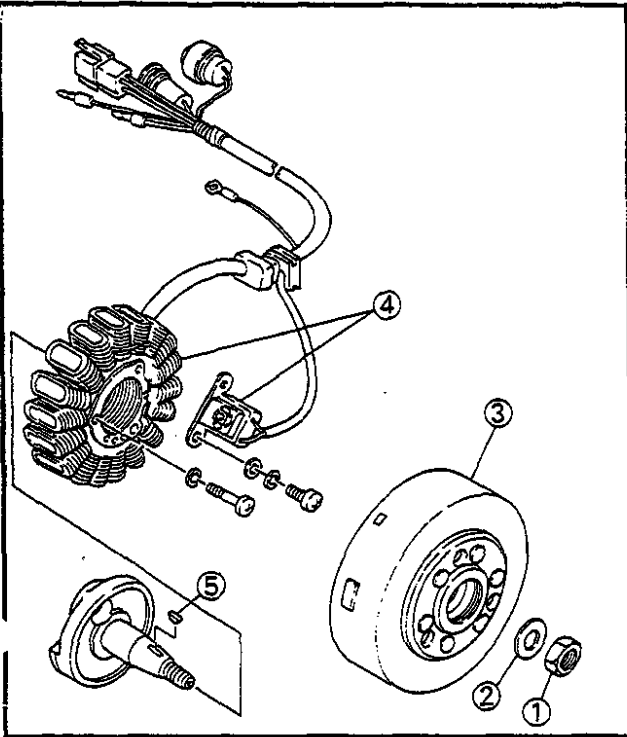

1. Remove:

- Nut ① (Rotor)
- Washer ②
- Rotor ③
- Stator coil assembly ④
- Woodruff key ⑤

NOTE:

Hold the rotor to loosen the nut (Rotor) by the Universal Rotor Holder ⑥.

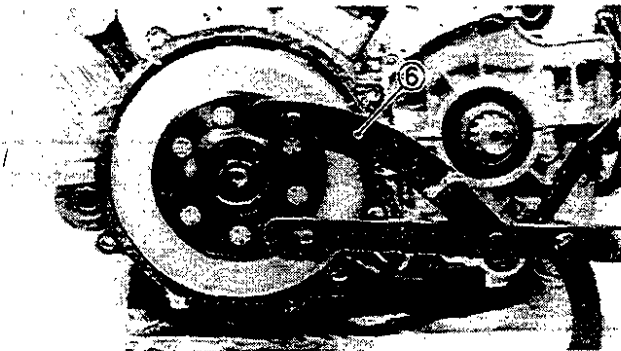

Universal Rotor Holder:
90890-01235

NOTE:

- Remove the rotor using the Flywheel puller ⑦.
- Flywheel puller has left-hand threads. Turn the flywheel puller counterclockwise to tighten it.

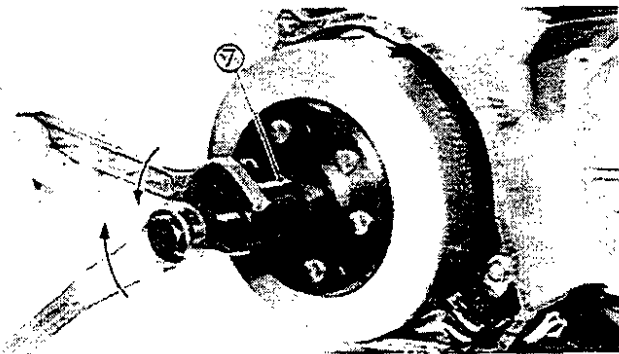

Flywheel Puller:
90890-01189

NOTE:

Before removing the stator coil, disconnect the neutral switch lead ⑧ from the neutral switch.

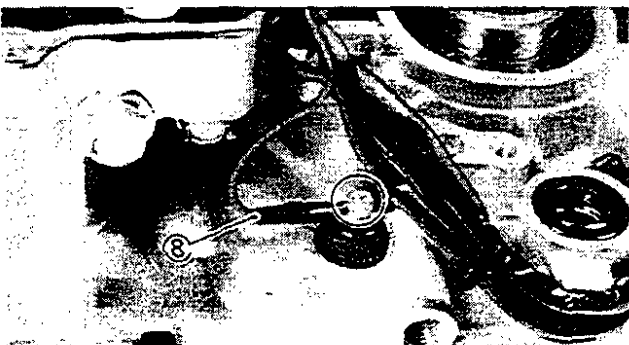



CRANKCASE (UPPER)

1. Remove:

- Bearing holder ①

2. Remove:

- Intake manifolds ①
- Reed valves
- Spacers
- Gaskets

3. Remove:

- Crankcase (Upper)
- Engine stay ①

NOTE:

- Loosen the bolts starting with the highest numbered one.
- Loosen each bolt 1/4 turn, and remove them after all bolts are loosened.

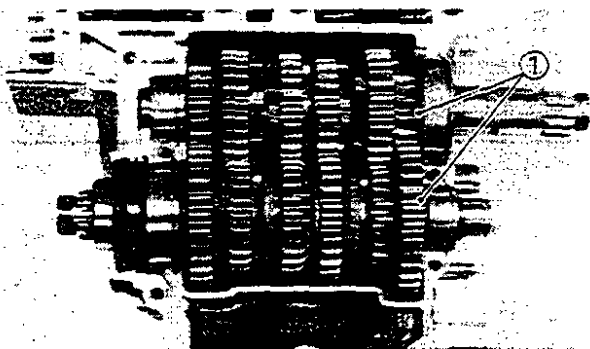
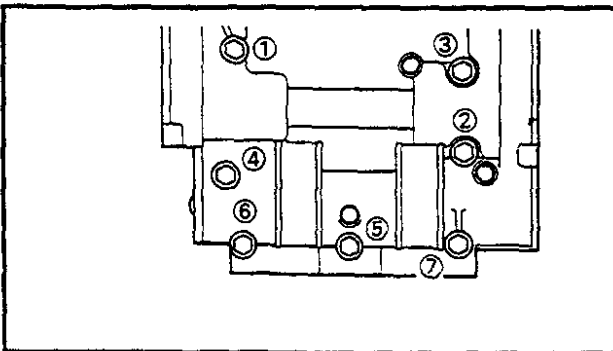
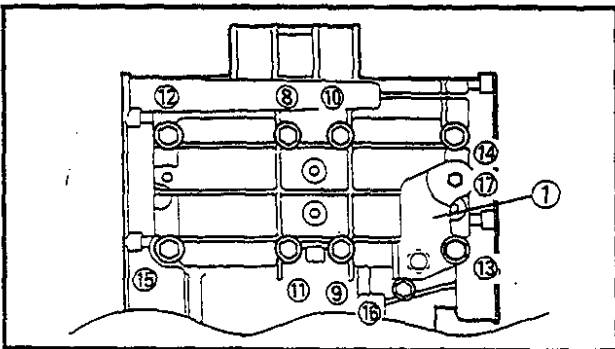
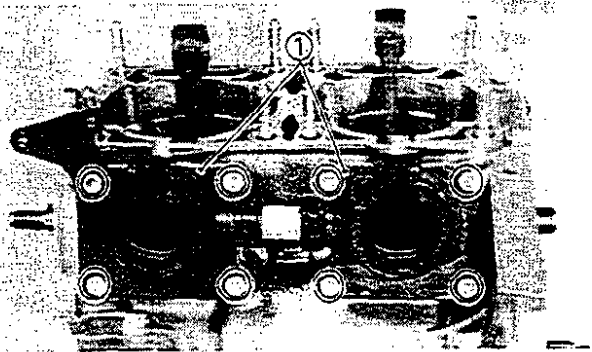
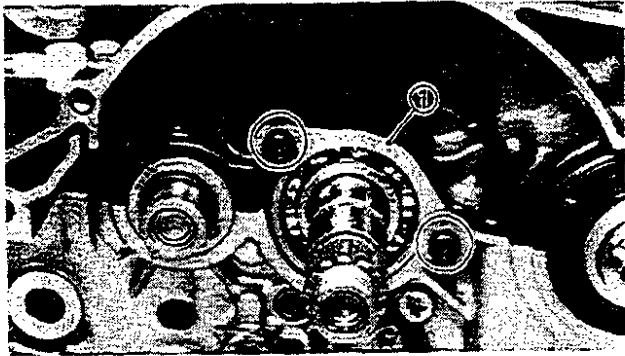

TRANSMISSION, SHIFTER AND CRANKSHAFT

1. Remove:

- Transmission assembly ①
- Stopper rings

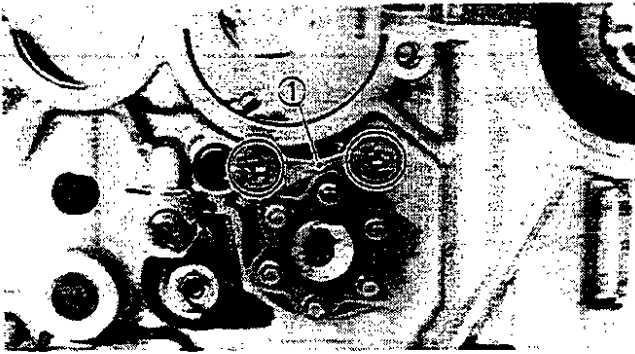

2. Remove:
- Stopper plate ① (Shift cam)

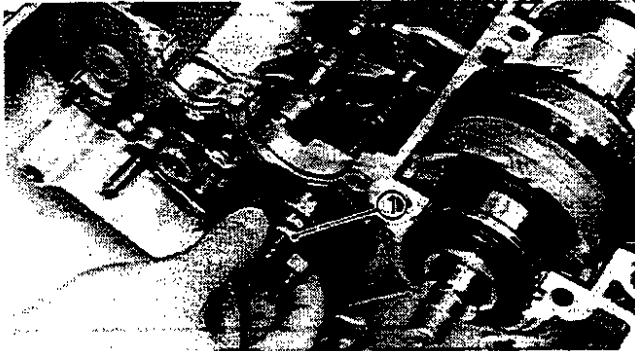

3. Remove:
- Shift cam ①

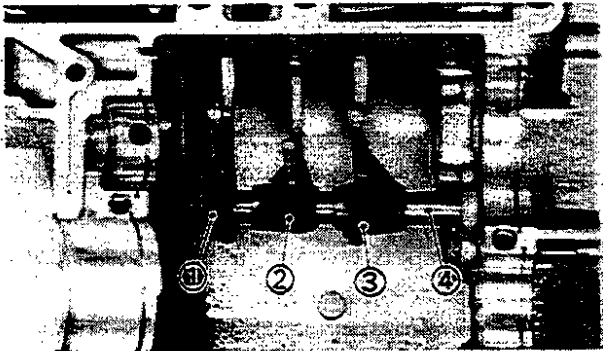

4. Remove:
- Shift fork #1 ①
 - Shift fork #2 ②
 - Shift fork #3 ③
 - Guide bar ④

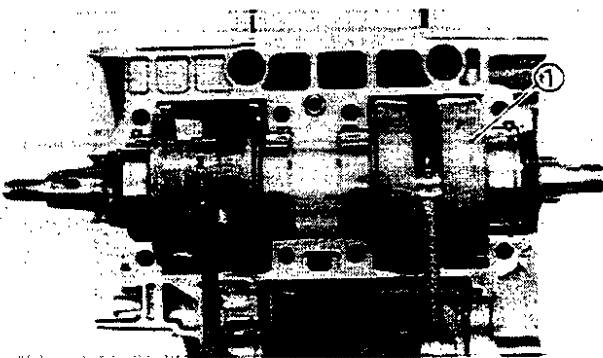

5. Remove:
- Crankshaft assembly ①
 - Stopper ring

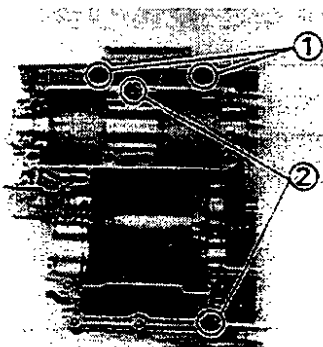

6. Remove:
- O-rings ①
 - Dowel pins ②



POWER VALVES

NOTE:

With the engine mounted, the power valves can be maintained by removing the following parts.

- Lower cowlings
- Mufflers
- YPVS cables
- Radiator
- Cylinder head
- Cylinder

1. Remove:

- Power valve holder ①
- Bolt ② (Power valve)
- Thrust plate ③
- Power valve ④ (Left)
- Power valve ⑤ (Right)

NOTE:

Remove the holder to maintain the power valve in the right-hand cylinder.

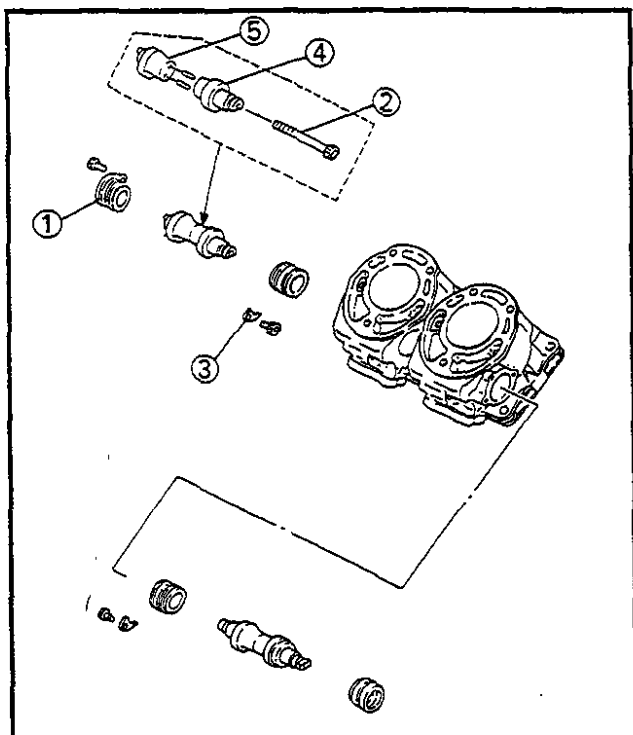

NOTE:

If stiff, use a wooden piece ⑥ through the exhaust port to steady the valve.

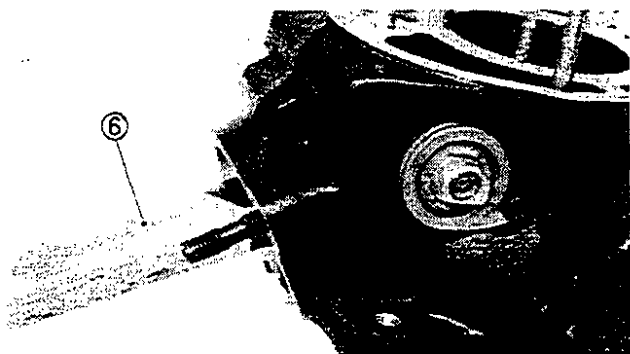

OIL PUMP AND STRAINER

NOTE:

With the engine mounted, the oil pump and strainer can be maintained by removing the following parts.

- Outlet hose
- Autolube pump cable and hose
- Crankcase cover (Right)

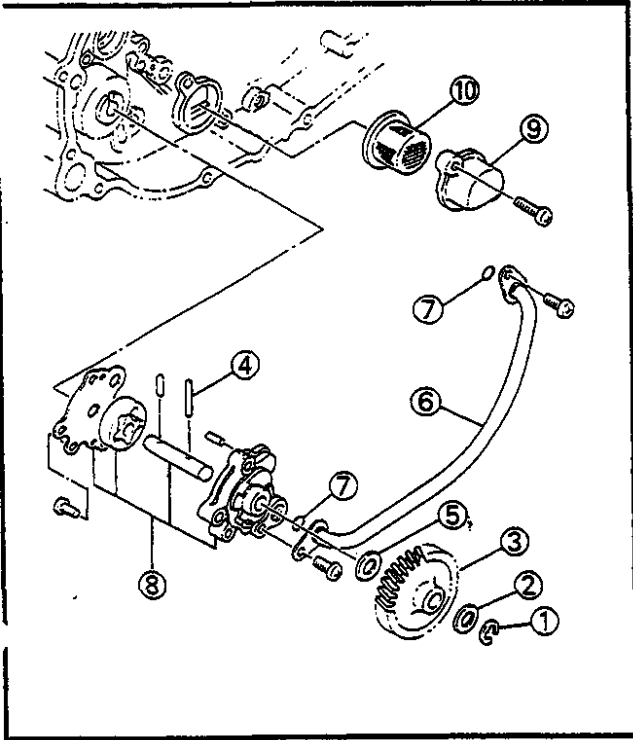

1. Remove:

- Circlip ①
- Washer ②
- Oil pump gear ③
- Pin ④
- Washer ⑤
- Oil delivery pipe ⑥
- O-ring ⑦
- Oil pump ⑧
- Strainer cover ⑨
- Strainer ⑩

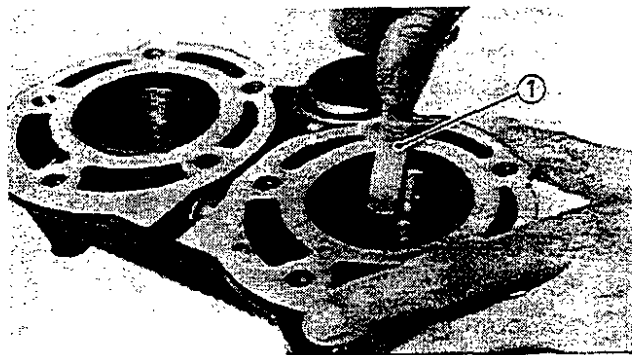

INSPECTION AND REPAIR CYLINDER HEAD

1. Eliminate:

- Carbon deposits
- Use a rounded scraper ①.

NOTE:

Take care to avoid damaging the spark plug threads. Do not use a sharp instrument. Avoid scratching the aluminum.

2. Inspect:

- Cylinder head water jacket.
- Crust of minerals/Rust → Remove.

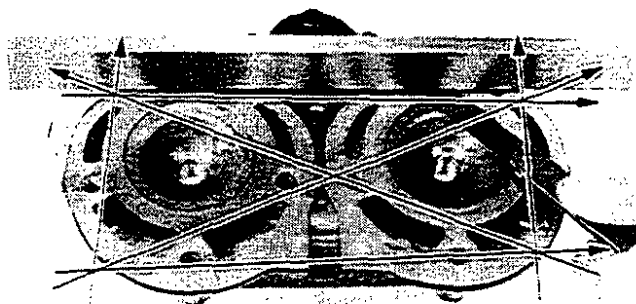

3. Measure:

- Cylinder head warpage
- Out of specification → Resurface.



Warpage Limit:
0.03 mm (0.0012 in)

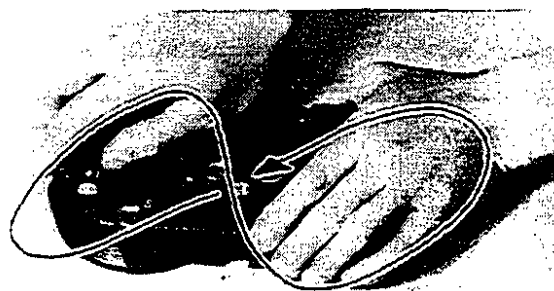

Warpage measurement and resurfacing steps:

- Attach a straight edge and a thickness gauge on the cylinder head.
- Measure the warpage.
- If the warpage is out of specification, resurface the cylinder head.
- Place a 400 – 600 grit wet sandpaper on the surface plate, and resurface the head using a figure-eight sanding pattern.

NOTE:

Rotate the head several times to avoid removing too much material from one side.

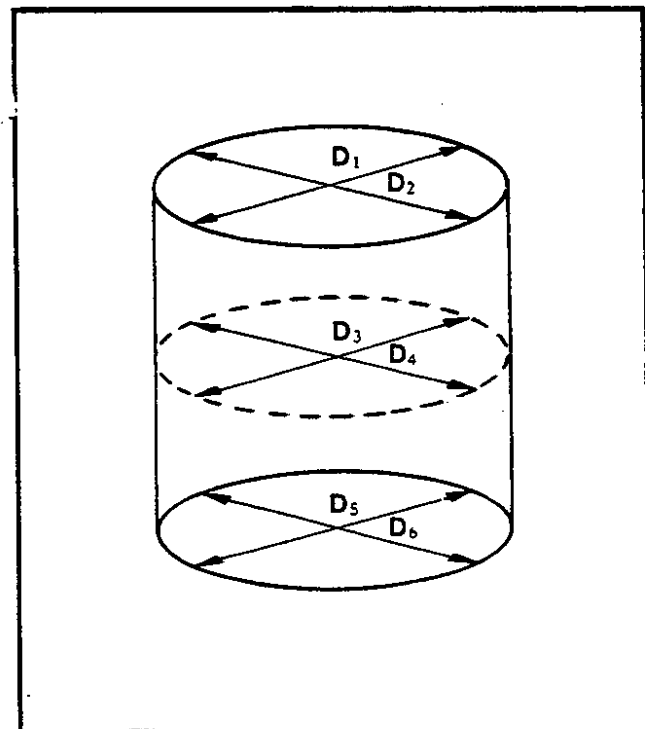
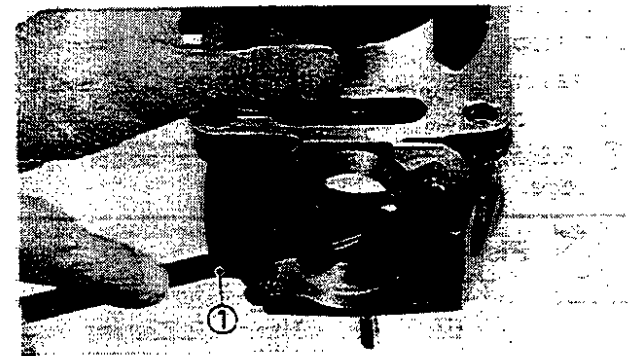
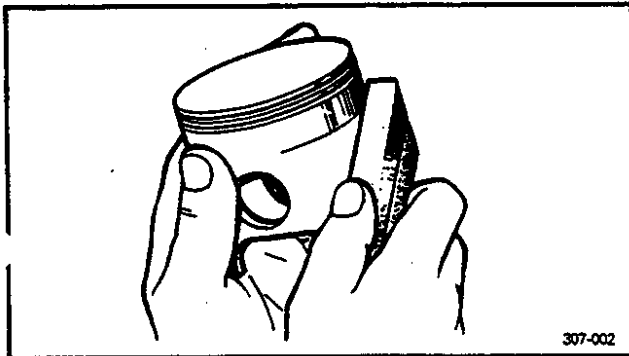
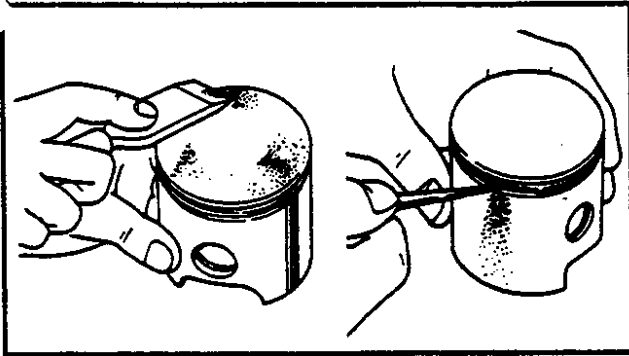

CYLINDER AND PISTON

1. Eliminate:
 - Carbon deposits
From the piston crown and ring grooves.
2. Eliminate:
 - Score marks and lacquer deposits
From the sides of piston.
Use a 600~800 grit wet sandpaper.

NOTE: _____
Sand in a crisscross pattern. Do not sand excessively.

3. Inspect:
 - Piston wall
Wear/Scratches/Damage → Replace.
4. Eliminate:
 - Carbon deposits
Use a rounded scraper ①.
5. Inspect:
 - Cylinder water jacket
Crust of minerals/Rust → Remove.
 - Cylinder wall
Wear/Scratches → Rebore or replace.
6. Measure:
 - Piston-to-cylinder clearance



Piston-to-cylinder clearance measurement steps:

First step:

- Measure the cylinder bore "C" with a Cylinder Bore Gauge.

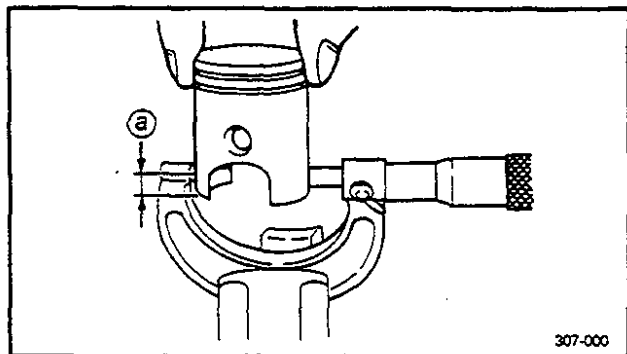
NOTE: _____
Measure the cylinder bore "C" in parallel to and at right angles to the crankshaft. Then, find the average of the measurements.



	Standard	Wear Limit
Cylinder Bore "C"	TDR250 56.40 – 56.42 mm (2.220 ~ 2.221 in) TDR240 55.20 ~ 55.22 mm (2.173 ~ 2.174 in)	TDR250 56.5 mm (2.224 in) TDR240 55.3 mm (2.177 in)
Taper "T"	—	0.05 mm (0.0019 in)
Out of Round "R"	—	0.05 mm (0.0019 in)
<p>C = Maximum D T = (Maximum D₁ or D₂) – (Maximum D₅ or D₆) R = (Maximum D₁, D₃ or D₅) – (Minimum D₂, D₄ or D₆)</p>		
<ul style="list-style-type: none"> • If out of specification, rebore or replace cylinder, and replace piston and piston rings as a set. <p>2nd step:</p> <ul style="list-style-type: none"> • Measure the piston skirt diameter "P" with a micrometer: ⓐ 15.0 mm (0.59 in) from the piston bottom edge. 		
	<p>Piston Size "P":</p> <p>TDR250 56.39 – 56.40 mm (2.220 in)</p> <p>TDR240 55.19 ~ 55.20 mm (2.173 in)</p>	
<ul style="list-style-type: none"> • If out of specification, replace piston and piston rings as a set. <p>3rd step:</p> <ul style="list-style-type: none"> • Calculate the piston-to-cylinder clearance with following formula: 		
<p>Piston-to-cylinder Clearance = Cylinder Bore "C" – Piston Skirt Diameter "P"</p>		
<ul style="list-style-type: none"> • If out of specification, rebore or replace cylinder, and replace piston and piston rings as a set. 		



Piston-to-cylinder Clearance:

TDR250

0.050 ~ 0.055 mm
(0.0020 ~ 0.0021 in)

TDR240

0.045 ~ 0.050 mm
(0.0018 ~ 0.0020 in)

Limit: 0.1 mm (0.004 in)

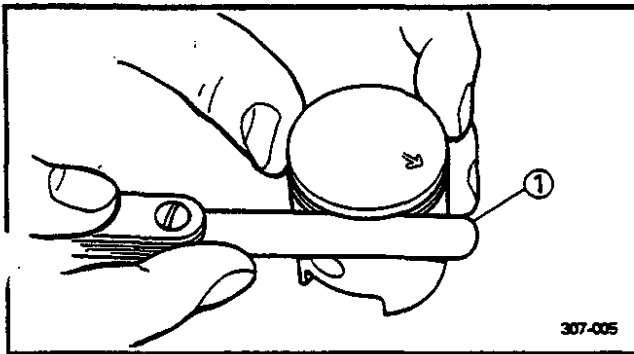

307-005

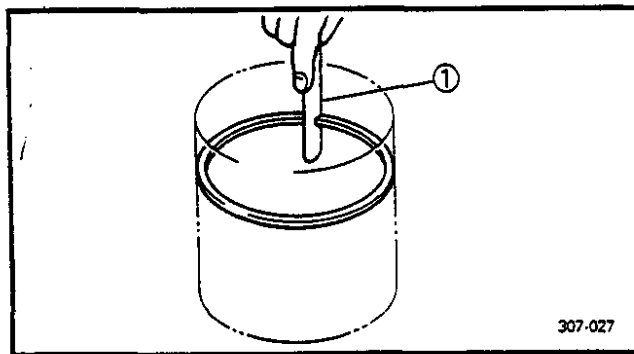

307-027

PISTON RINGS

1. Measure:

- Side clearance

Out of specification → Replace piston and/or rings.

Use a Feeler Gauge ①.



Side Clearance

Top	0.020 ~ 0.060 mm (0.0008 ~ 0.0024 in)
2nd	0.030 ~ 0.065 mm (0.0012 ~ 0.0026 in)

2. Install:

- Piston ring

(Into the cylinder)

Push the ring with the piston crown.

3. Measure:

- End gap

Out of specification → Replace rings as a set.

Use a Feeler Gauge ①.



End Gap

Top	0.30 ~ 0.45 mm (0.012 ~ 0.018 in)
2nd	0.30 ~ 0.45 mm (0.012 ~ 0.018 in)

PISTON PIN AND BEARING

1. Lubricate:

- Piston pin (Lightly)

2. Install:

- Small end bearing

- Piston pin

(Into the small end of connecting rod)

3. Check:

- Free play

There should be no noticeable for the play.

Free play exists → Inspect the connecting rod for wear/Replace the pin and/or connecting rod as required.

4. Install:

- Piston pin

(Into the piston pin hole)

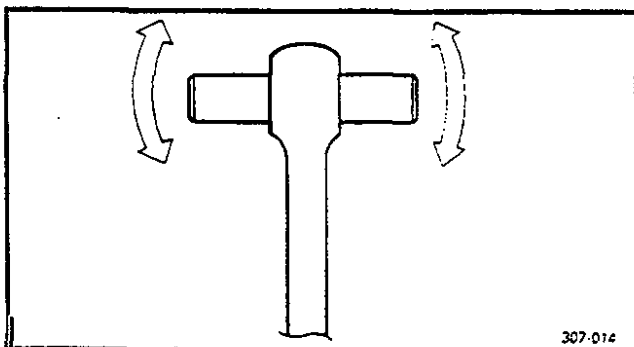

307-014

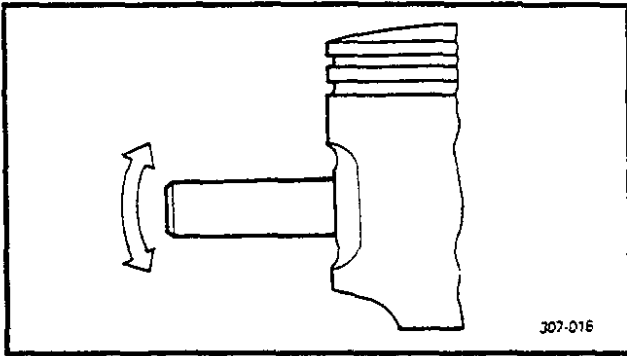

5. Check:
 - Free play (when the piston pin is in place in the piston)
There should be no noticeable for the play. Free play exists → Replace piston pin and/or piston.
6. Inspect:
 - Piston pin and bearing
Signs of heat discoloration → Replace.

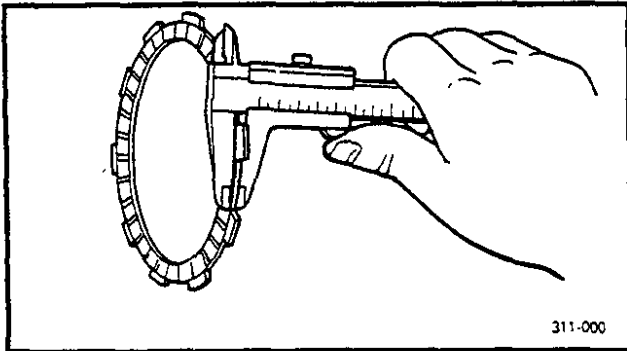

CLUTCH

1. Inspect:
 - Friction plate
Damage/Wear → Replace friction plate as a set.
2. Measure:
 - Friction plate thickness
Out of specification → Replace friction plate as a set.
Measure at all four point.

 **Wear Limit: 2.8 mm (0.11 in)**

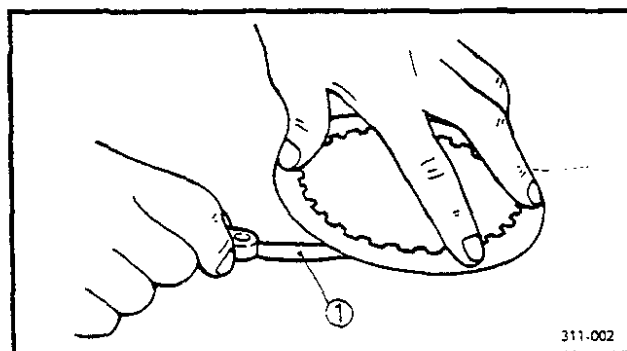

3. Inspect:
 - Clutch plate
Damage → Replace clutch plate as a set.

4. Measure:
 - Clutch plate warpage
Out of specification → Replace clutch plate as a set.
Use a surface plate and Feeler Gauge ①.

 **Warp Limit: 0.1 mm (0.004 in)**

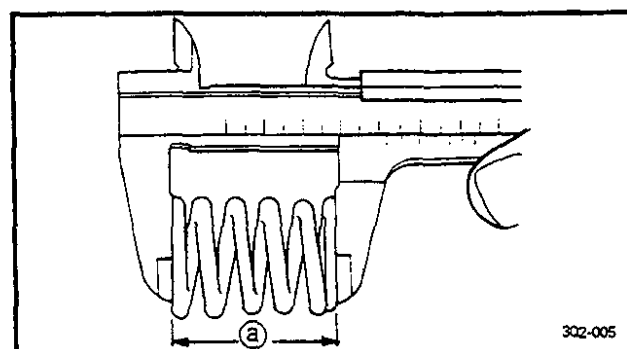

5. Measure:
 - Clutch spring free length ②
Out of specification → Replace spring as a set.

 **Clutch Spring Minimum Length: 32.9 mm (1.295 in)**

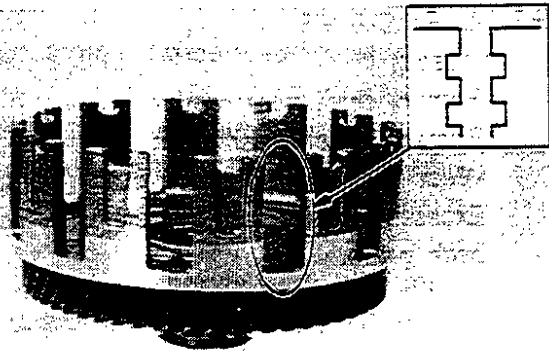

6. Inspect:

- Dogs on the clutch housing
Cracks/Wear/Damage → Deburr or replace.
- Clutch housing bearing
Scoring/Wear/Damage → Replace clutch housing.

NOTE:

Scoring on the clutch housing dogs will cause erratic operation.

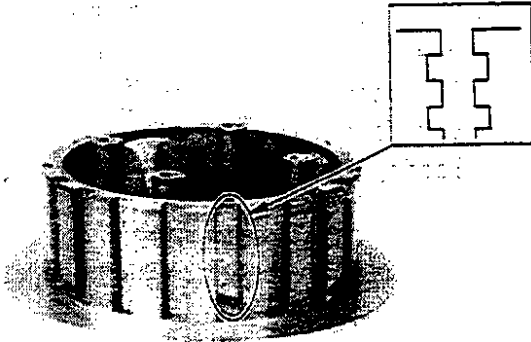

7. Inspect:

- Clutch boss splines
Scoring/Wear/Damage → Replace clutch boss.

NOTE:

Scoring on the clutch boss splines will cause erratic operation.



8. Check:

- Circumferential play
Free play exists → Replace.

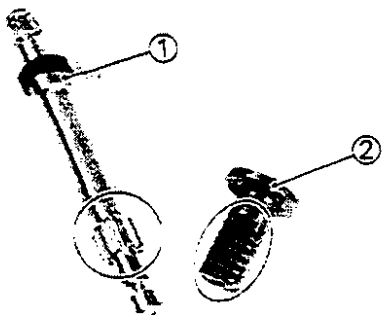

9. Inspect:

- Pull lever ①
- Pull rod ②
- Wear/Damage → Replace.

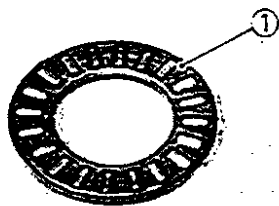

10. Inspect:

- Bearing ① (Pull rod)
- Wear/Damage → Replace.

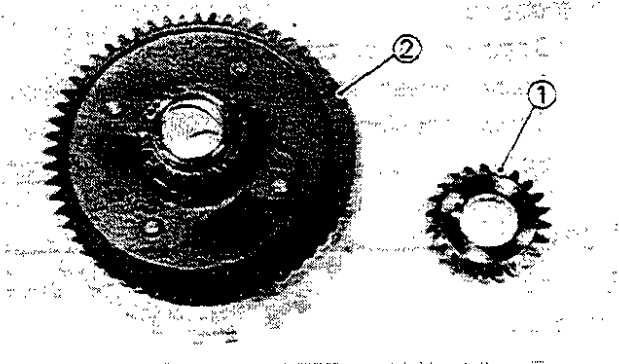

PRIMARY DRIVE

1. Inspect:

- Primary drive gear teeth ①
 - Primary driven gear teeth ②
- Wear/Damage → Replace both gears.
Excessive noises during operation → Replace both gears.

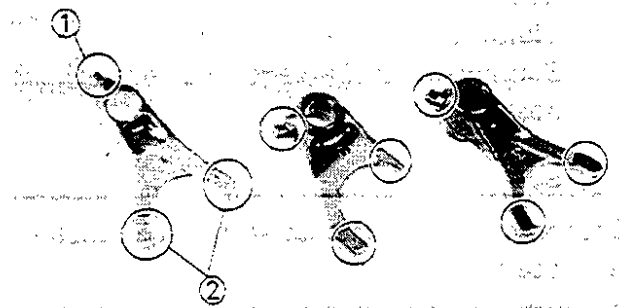

TRANSMISSION AND SHIFTER

1. Inspect:

- Shift fork cam follower ①
 - Shift fork pawl ②
- Scoring/Bends/Wear → Replace.

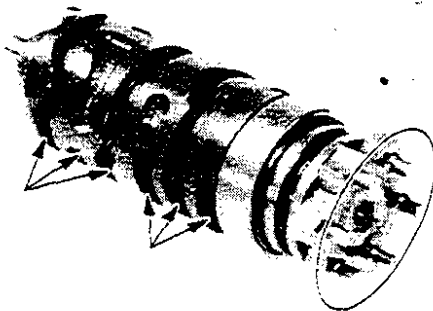

2. Inspect:

- Shift cam groove
 - Shift cam segment
- Wear/Damage → Replace.

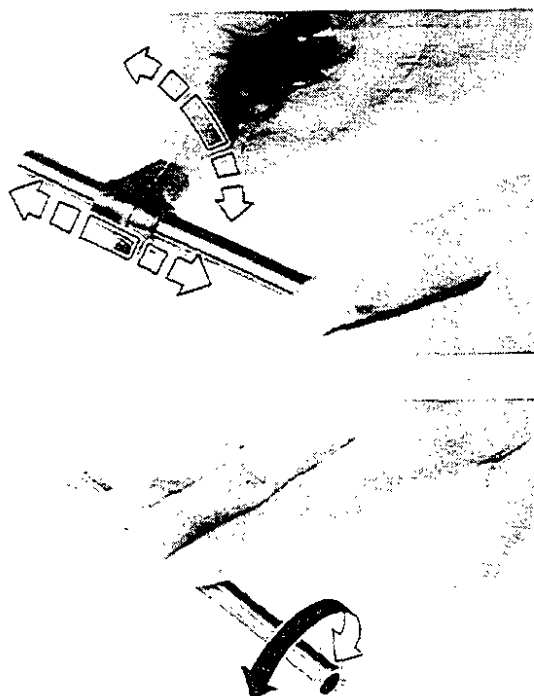

3. Check:

- Shift fork movement
- Unsmooth operation → Replace shift fork and/or guide bar.

4. Inspect:

- Guide bar
- Roll the guide bar on a flat surface.
Bends → Replace.

WARNING:

Do not attempt to straighten a bent guide bar.



5. Measure:

- Axle runout

Use centering device and dial gauge.

Out of specification → Replace bent axle.

**Runout Limit:**

0.08 mm (0.003 in)

6. Inspect:

- Gear teeth

Blue discoloration/Pitting/Wear → Replace.

- Mated dogs

Rounded edges/Cracks/Missing portions
→ Replace.

7. Check:

- Proper gear engagement (Each gear)
(to its counter part)

Incorrect → Reassemble.

- Gear movement

Roughness → Replace.

8. Inspect:

- Circlips

Damage/Looseness/Bends → Replace.

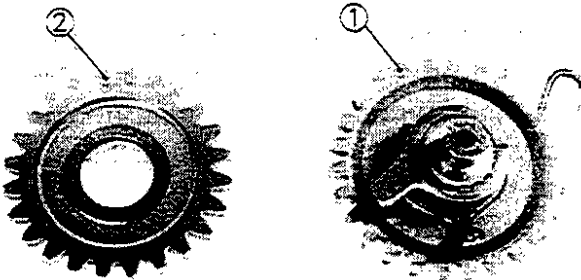
**KICK STARTER**

1. Inspect:

- Kick gear teeth ①

- Kick idle gear teeth ②

Damage/wear → Replace both gears.

2. Measure:

- Kick clip tension

Out of specification → Replace.

Use a spring balance ①.

Kick Clip Tension:

0.8~1.3 kg (1.76~2.87 lb)

CAUTION:

Do not try to bend the clip.

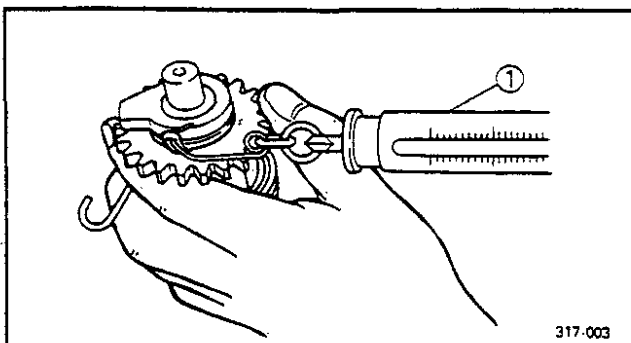

317-003

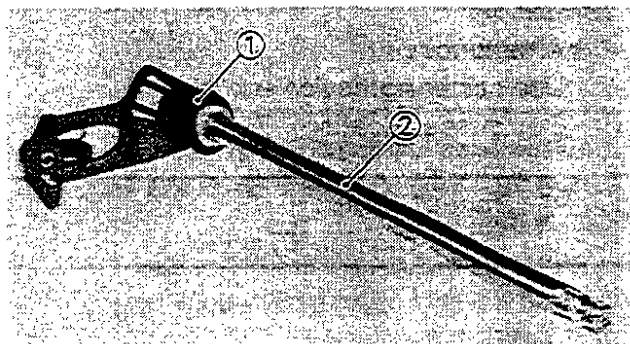
**SHIFT SHAFT**

1. Inspect:

- Spring ①
Damage → Replace.
- Shift shaft ②
Damage/Bends/Wear → Replace.

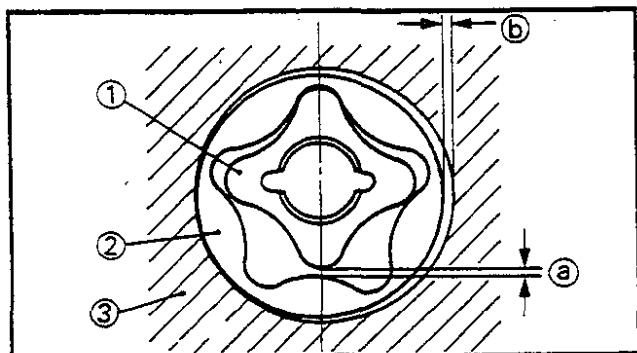
**OIL PUMP**

1. Measure:

- Tip clearance ①
(between inner rotor ① and outer rotor ②)
 - Side clearance ②
(between outer rotor ② and pump housing ③)
- Out of specifications → Replace oil pump.

Oil Pump Clearance:	
Tip Clearance < Limit >	0.10 ~ 0.15 mm (0.004 ~ 0.006 in) < 0.17 mm (0.007 in) >
Side Clearance < Limit >	0.04 ~ 0.09 mm (0.002 ~ 0.004 in) < 0.12 mm (0.005 in) >

AUTOLUBE PUMP

Wear or an internal malfunction may cause pump output to vary from the factory setting. This situation is, however, extremely rare. If improper output is suspected, inspect the following:

1. Inspect:

- Delivery line
Obstructions → Blow out.
- Pump body seal/Crankcase cover seal
Wear/Damage → Replace.
- Check ball/Spring
Miss/Improper → Repair.

2. Inspect:

- Allowing air
Air exists → Air bleed.



3. Check:

- Pump output
Out of specification → Adjust.

Minimum Output/200 Stroke:
 0.75 ~ 1.00 cm³ (0.026 ~ 0.035 Imp oz,
 0.025 ~ 0.034 US oz)
Maximum Output/200 Stroke:
 10.3 ~ 11.4 cm³ (0.36 ~ 0.40 Imp oz,
 0.35 ~ 0.39 US oz)

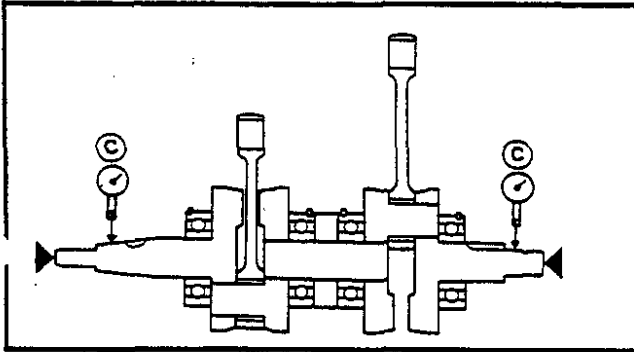

CRANKSHAFT

1. Measure:

- Runout
Use a centering device and Dial Gauge.
Out of specification → Replace or repair.



Runout Limit:
 0.03 mm (0.0012 in)

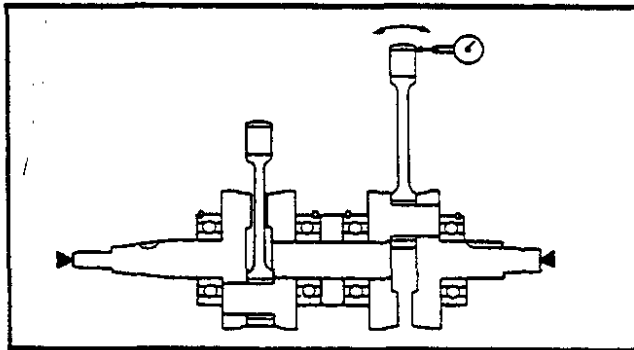

2. Measure:

- Small end free play
Use a Dial Gauge.
Out of specification → Replace the defective parts.



Small End Free Play:
 0.4 ~ 0.6 mm (0.016 ~ 0.024 in)
 < Limit >:
 < 1.0 mm (0.039 in) >

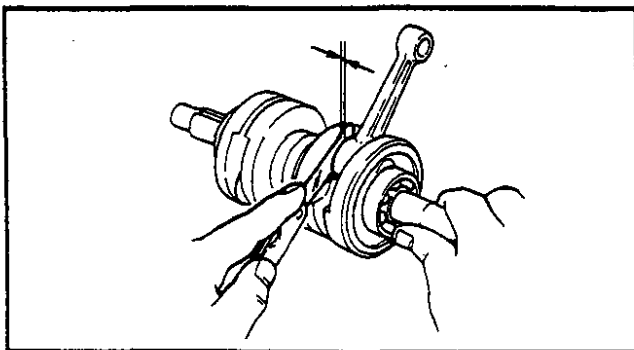

3. Measure:

- Big end side clearance
Use a Feeler Gauge.
Out of specification → Replace the defective parts.



Big End Side Clearance:
 0.25 ~ 0.75 mm (0.010 ~ 0.030 in)
 < Limit >:
 < 1.0 mm (0.039 in) >



4. Inspect:
 - Crankshaft bearing
Pitting/Damage→Replace.

NOTE: _____
Lubricate the bearing immediately after examining them to prevent rust.

5. Inspect:
 - Stopper rings
Bend/Damage→Replace.
 - Oil seals
Wear/Damage→Replace.

CRANKCASE

1. Thoroughly wash the case halves in mild solvent.
2. Clean all the gasket mating surfaces and crankcase mating surfaces thoroughly.
3. Inspect:
 - Crankcase
Cracks/Damage→Replace.
 - Oil delivery passages
Clog→Blow out with compressed air.

OIL PIPE AND STRAINER

1. Inspect:
 - Oil delivery pipe ①
Cracks/Damage→Replace.
Clog→Blow out with compressed air.
 - O-rings ②
Damage→Replace.
2. Inspect:
 - Oil strainer ①
Damage→Replace.

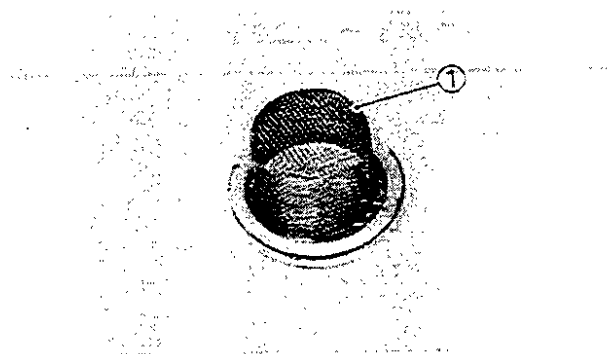
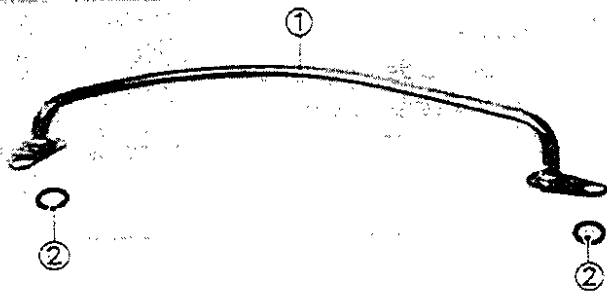

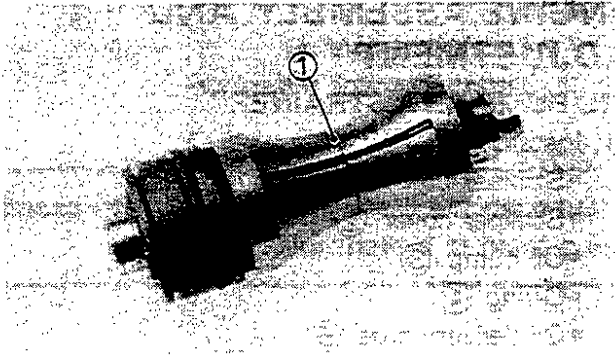

POWER VALVE

1. Remove:

- Score marks and lacquer deposits
From curved surface (especially cleaning groove ①).

2. Inspect:

- O-rings
- Bushes
- Oil seals

Wear/Damage → Replace.

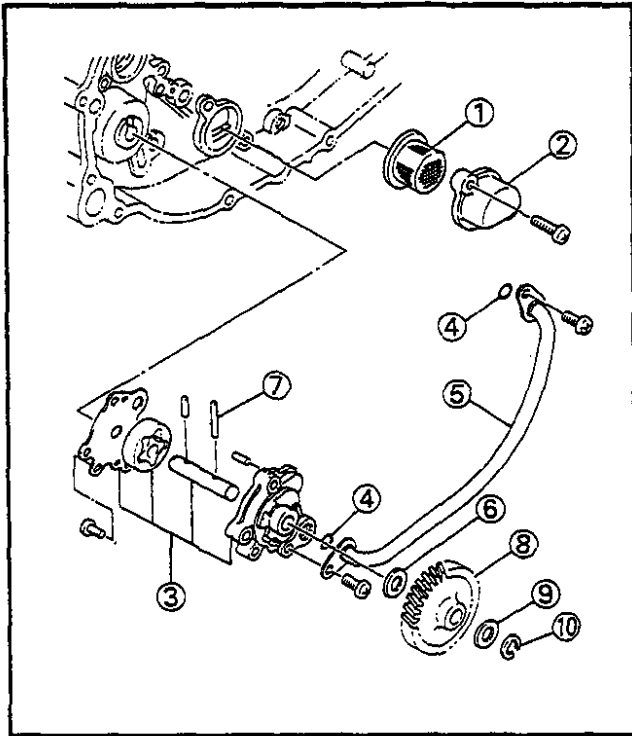

ENGINE ASSEMBLY AND ADJUSTMENT

OIL PUMP AND STRAINER

1. Install:

- Strainer ①
- Strainer cover ②
- Oil pump ③
- O-ring ④
- Oil delivery pipe ⑤
- Washer ⑥
- Pin ⑦
- Oil pump gear ⑧
- Washer ⑨
- Circlip ⑩



Screws (Strainer Cover):

5 Nm (0.5 m·kg, 3.6 ft·lb)
Use LOCTITE®.

Screws (Oil Pump):

5 Nm (0.5 m·kg, 3.6 ft·lb)
Use LOCTITE®.

Screws (Oil Delivery Pipe):

5 Nm (0.5 m·kg, 3.6 ft·lb)
Use LOCTITE®.



OIL PUMP AND STRAINER

- ① Strainer
- ② Strainer housing
- ③ O-ring
- ④ Oil delivery pipe
- ⑤ Oil pump gear
- ⑥ Oil pump housing
- ⑦ Shaft
- ⑧ Rotor
- ⑨ Oil pump cover

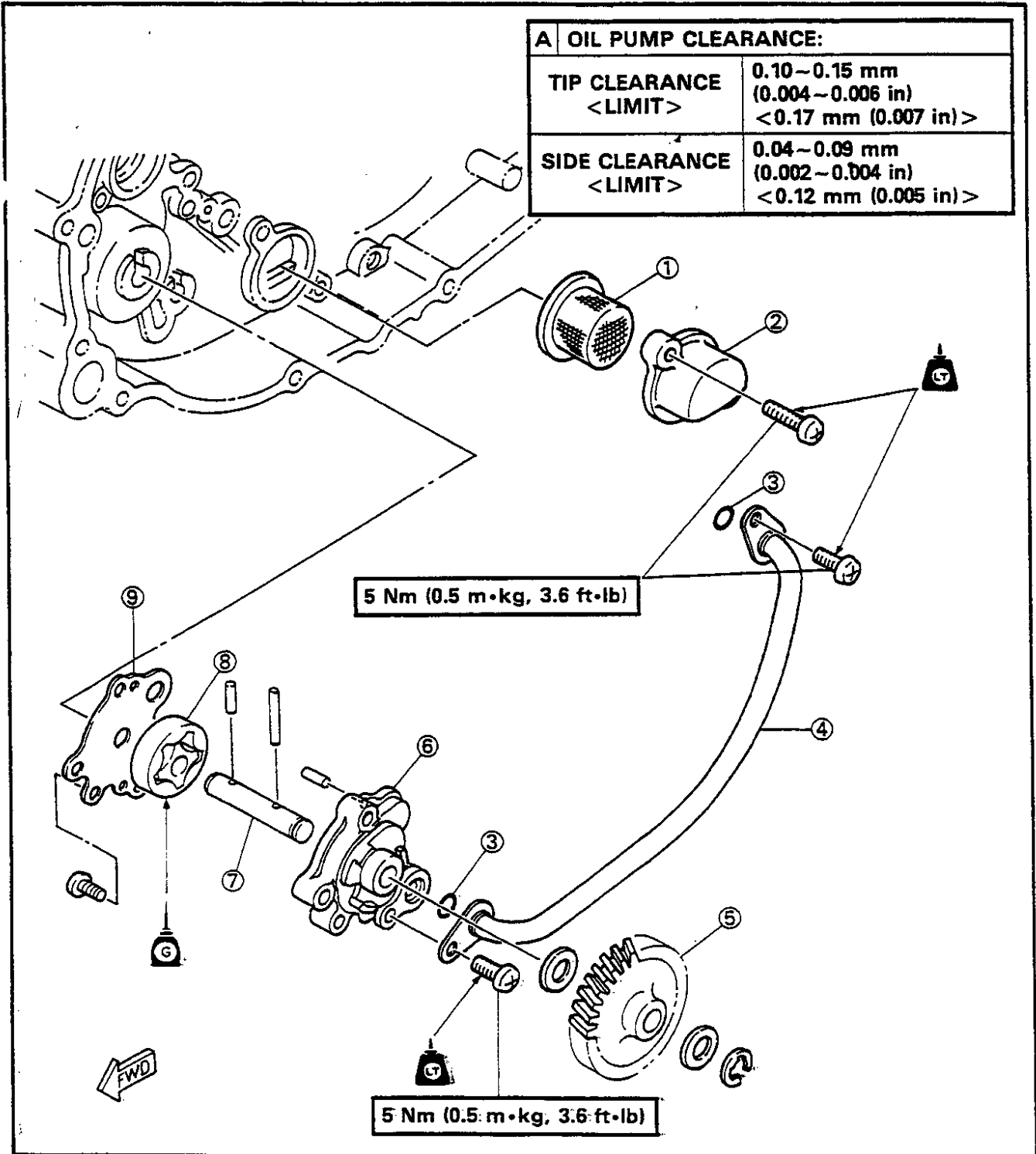

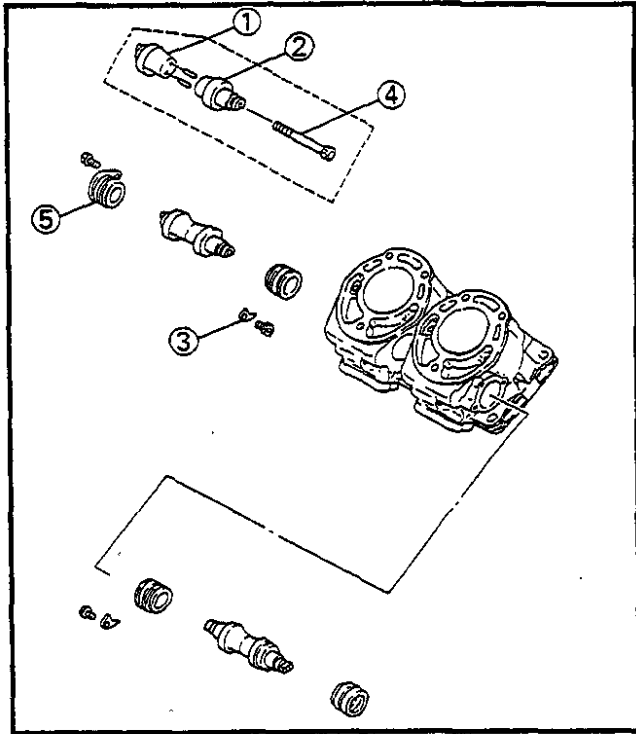

POWER VALVES

1. Install:

- Power valve ① (Right)
- Power valve ② (Left)
- Thrust plate ③
- Bolt ④ (Power valve)
- Power valve holder ⑤



Bolt (Thrust Plate):

7 Nm (0.7 m·kg, 5.1 ft·lb)

Bolt (Power Valve):

7 Nm (0.7 m·kg, 5.1 ft·lb)

Bolt (Power Valve Holder):

7 Nm (0.7 m·kg, 5.1 ft·lb)

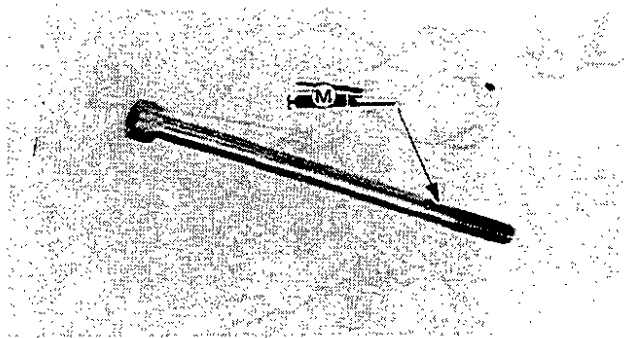

NOTE:

Apply a molybdenum disulfide grease to the bolt (Power valve).

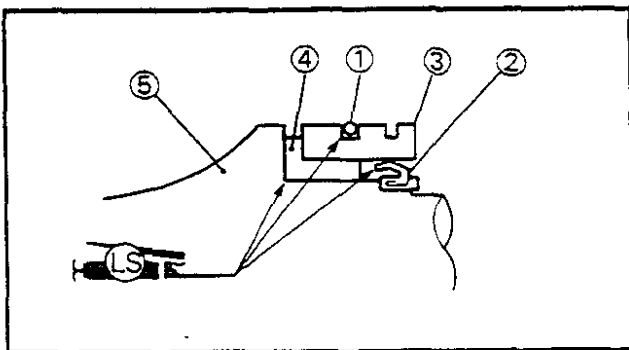

NOTE:

Apply a lithium soap base grease to the O-ring, oil seal and solid bush as shown.

- ① O-ring
- ② Oil seal
- ③ Holder
- ④ Solid bush
- ⑤ Power valve



POWER VALVE

- | | |
|----------------------------|---------------------------|
| ① Power valve holder | ⑩ O-ring |
| ② O-ring | ⑪ Power valve (Left-hand) |
| ③ Power valve (Right-hand) | ⑫ Holder |
| ④ Power valve holder | ⑬ Oil seal |
| ⑤ Oil seal | ⑭ Thrust plate |
| ⑥ Thrust plate | ⑮ YPVS cable |
| ⑦ Joint | ⑯ Pulley housing |
| ⑧ Oil seal | ⑰ Pulley |
| ⑨ Power valve holder | ⑱ Pulley cover |

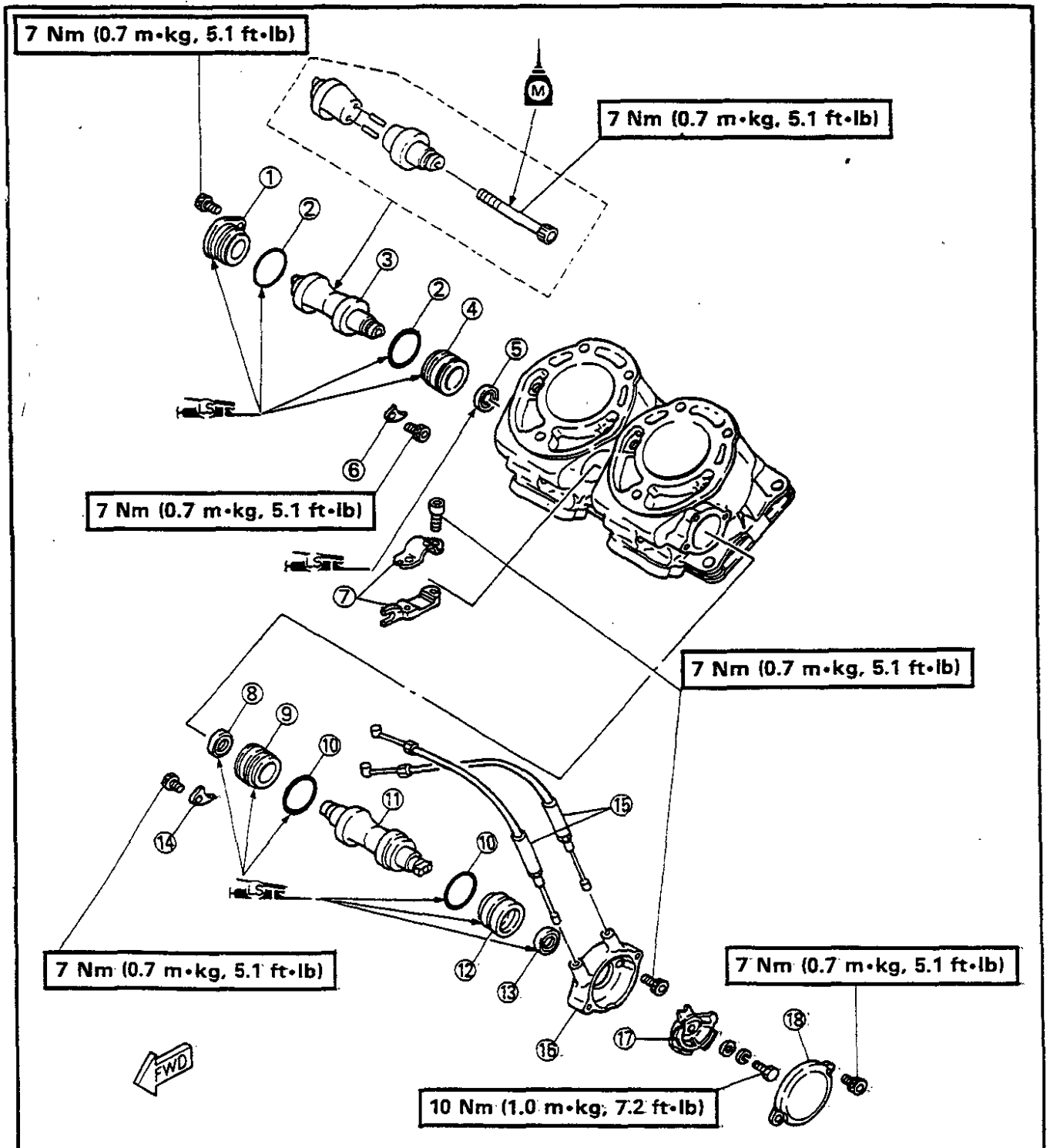

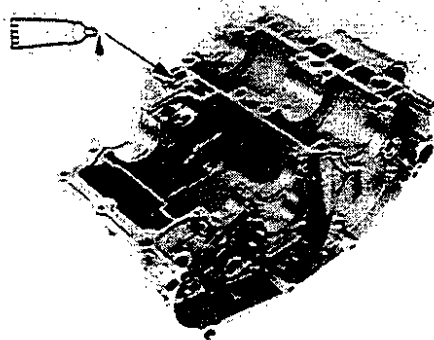

TRANSMISSION, SHIFTER AND CRANKSHAFT

1. Apply:

- Yamaha Bond No. 4
To the mating surfaces of both crankcase halves.



Yamaha Bond No. 4:
90890-05143

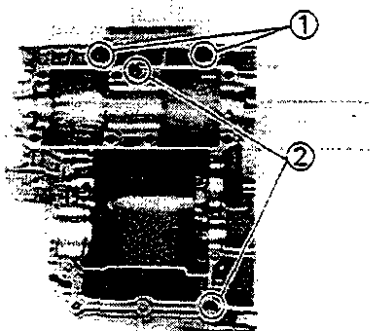

2. Install:

- O-rings ①
- Dowel pins ②
Onto the crankcase (Lower).

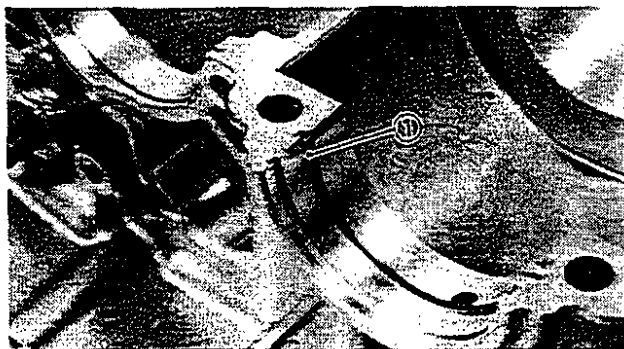

3. Install:

- Stopper ring ①
On the clutch side.

4. Apply:

- Lithium soap base grease
To the oil seal lips.
- Engine oil
To the bearings.

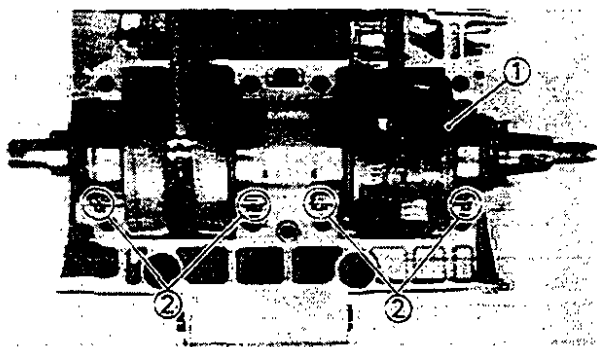

5. Install:

- Crankshaft assembly ①

NOTE:

- Align the bearing knock pin ② with the pin slot in the crankcase lower half:
- Be sure the stopper ring is fitted to the bearing and the stopper ring have been positioned in the ring groove:

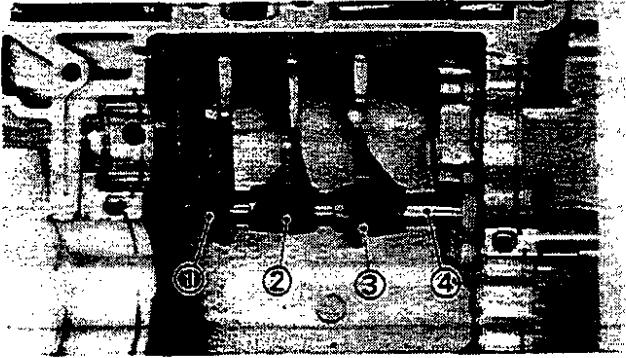

6. Install:

- Shift fork #1 ①
- Shift fork #2 ②
- Shift fork #3 ③
- Guide bar ④

NOTE:

Each shift fork is identified by a number cast on its side. All the numbers should face right side.

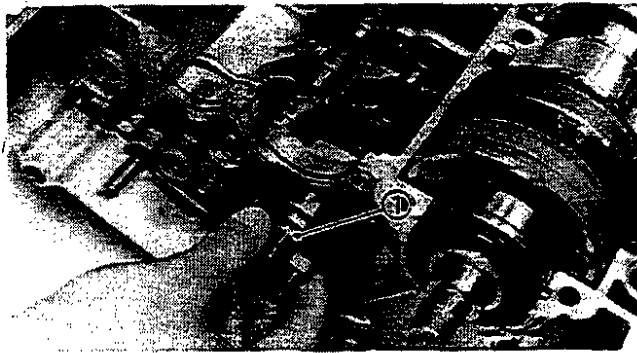
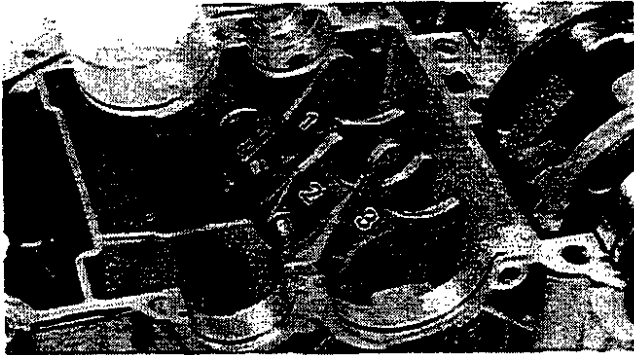

7. Install:

- Shift cam ①

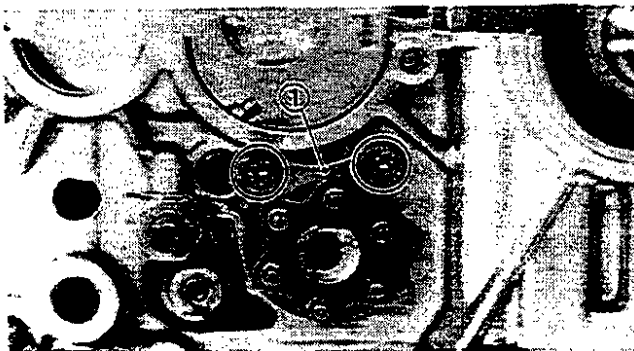

8. Install:

- Stopper plate ① (Shift cam)

	<p>Screws (Stopper Plate): 8!Nm (0.8 m·kg, 5.8 ft·lb) Use LOCTITE®.</p>
---	--

NOTE:

Be sure the stopper plate is fitted in the groove of the shift cam.

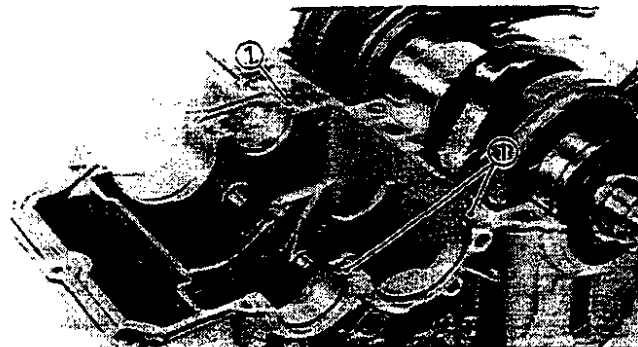

9. Install:

- Stopper rings ①

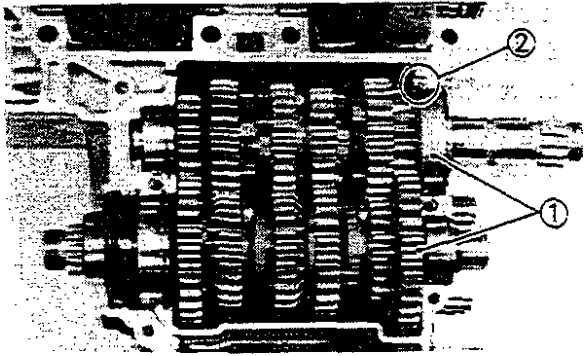

10. Install:

- Transmission assembly ①

NOTE:

- Align the bearing knock pin ② with the pin slot in the crankcase lower half.
- Be sure the stopper ring is fitted to the bearing and the stopper ring have been positioned in the ring groove.

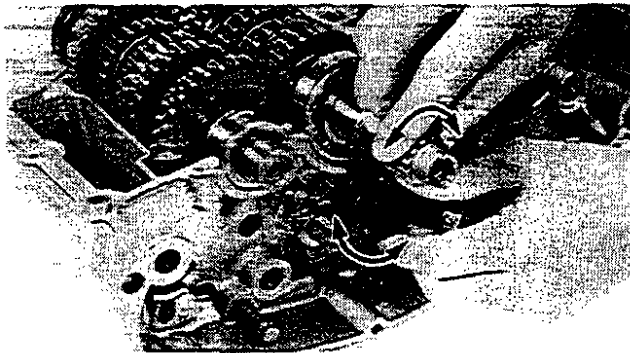

11. Check:

- Shifter and transmission operation
Unsmooth operation → Repair.



CRANKSHAFT, PISTON AND PISTON RING

- ① Oil seal
- ② Bearing
- ③ Woodruff key
- ④ Crank (Left)
- ⑤ Washer
- ⑥ Connecting rod
- ⑦ Big end bearing
- ⑧ Washer
- ⑨ Crank (Right)
- ⑩ Bearing
- ⑪ Circlip
- ⑫ Oil seal
- ⑬ Small end bearing
- ⑭ Piston pin clip
- ⑮ Piston pin
- ⑯ Piston
- ⑰ Piston ring set

PISTON TO CYLINDER CLEARANCE:
TDR250
 0.050 ~ 0.055 mm (0.0020 ~ 0.0021 in)
A TDR240
 0.045 ~ 0.050 mm (0.0018 ~ 0.0020 in)
< LIMIT >
 < 0.1 mm (0.004 in) >

END GAP (INSTALLED):
TOP RING
B 0.30 ~ 0.45 mm (0.012 ~ 0.018 in)
2nd RING
 0.30 ~ 0.45 mm (0.012 ~ 0.018 in)

SIDE CLEARANCE:
TOP RING
C 0.020 ~ 0.060 mm (0.0008 ~ 0.0024 in)
2nd RING
 0.030 ~ 0.065 mm (0.0012 ~ 0.0026 in)

E USE NEW ONE

E USE NEW ONE

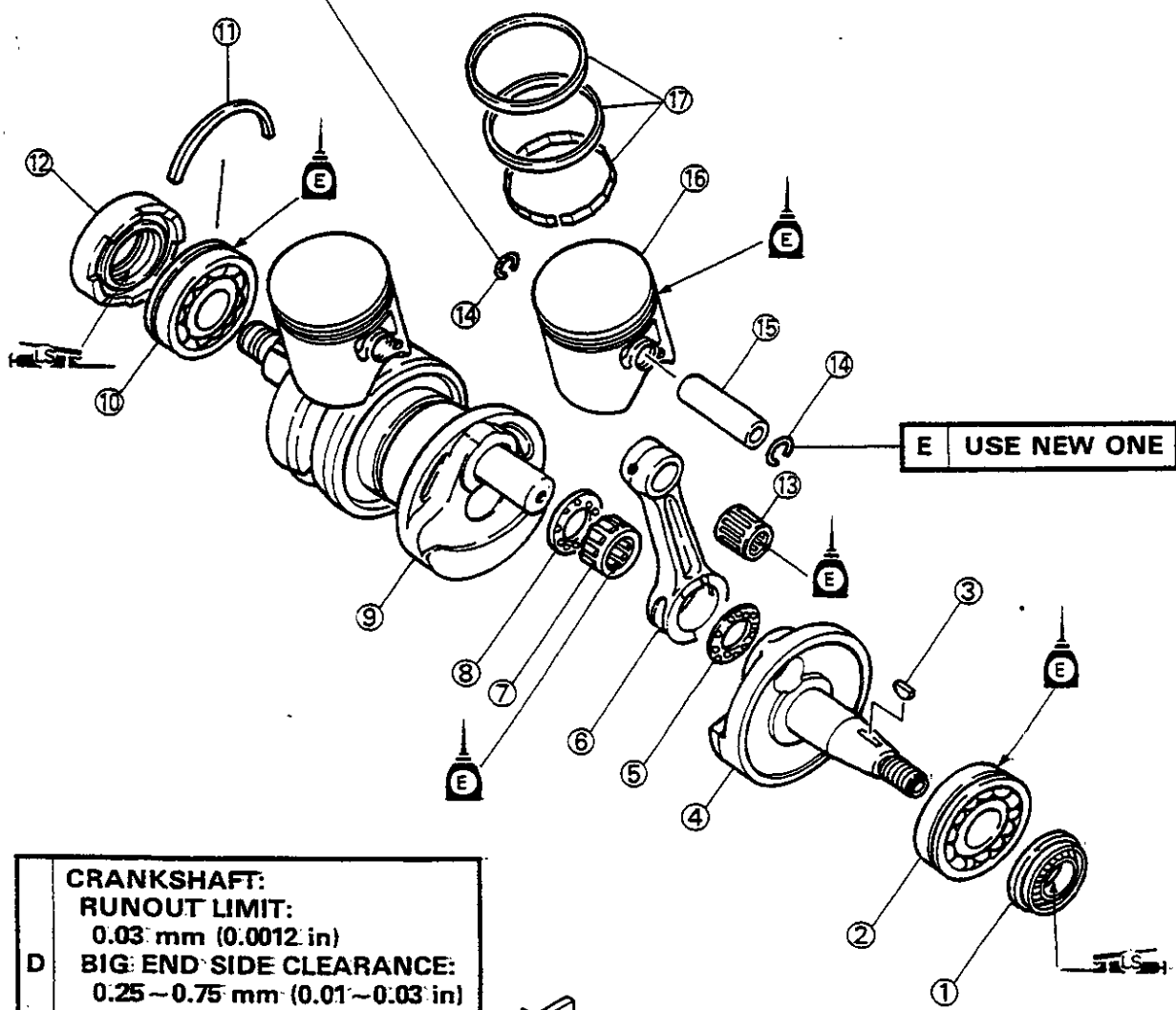

CRANKSHAFT:
RUNOUT LIMIT:
 0.03 mm (0.0012 in)
D BIG END SIDE CLEARANCE:
 0.25 ~ 0.75 mm (0.01 ~ 0.03 in)
SMALL END FREE PLAY:
 0.4 ~ 0.6 mm (0.016 ~ 0.024 in)





SHIFTER

- ① Shift fork #3
- ② Shift fork #2
- ③ Shift fork #1
- ④ Guide bar
- ⑤ Stopper plate
- ⑥ Shift cam
- ⑦ Bearing
- ⑧ Stopper lever
- ⑨ Return spring

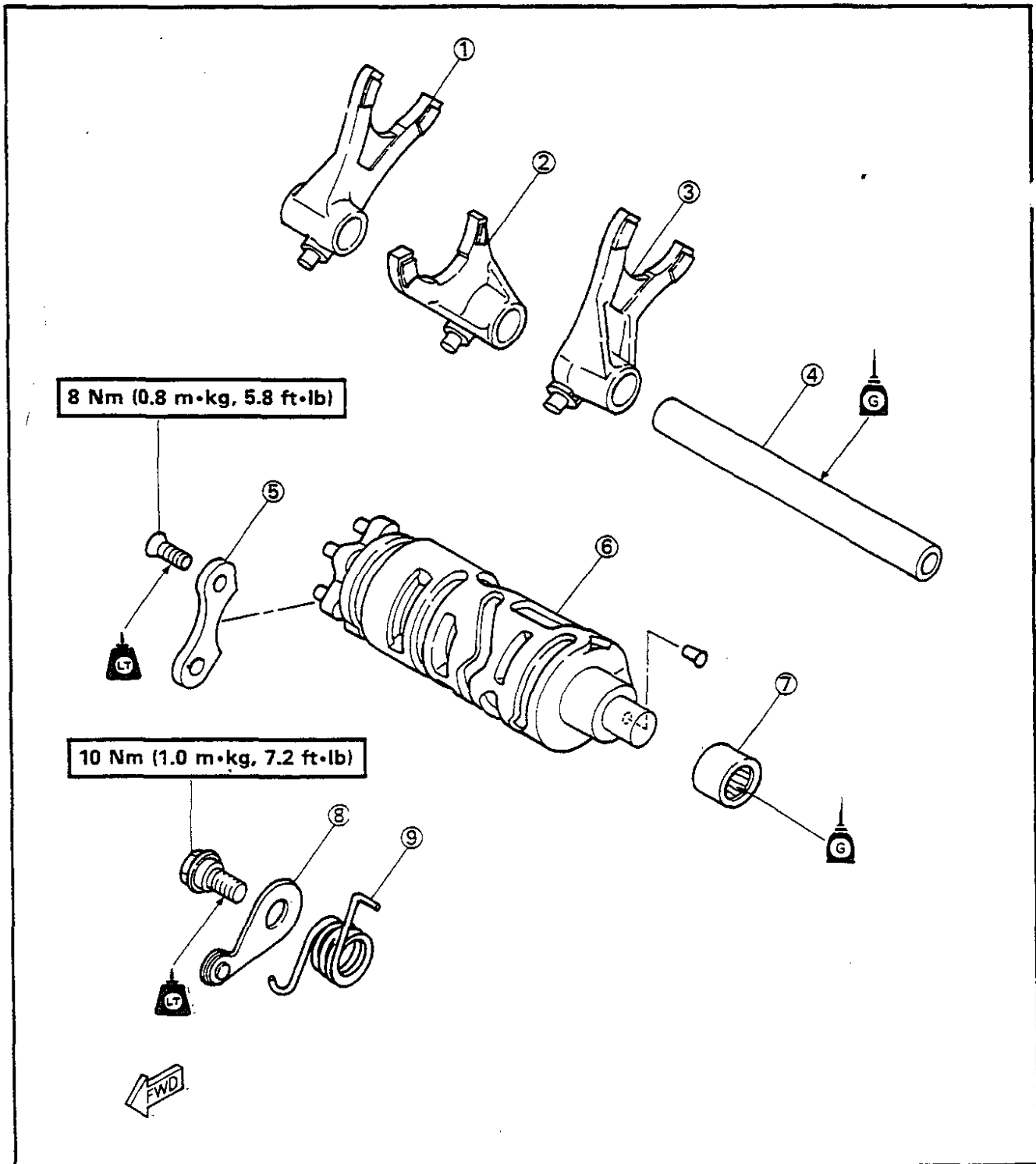



TRANSMISSION

- | | | |
|------------------|-----------------------|-------------------|
| ① Drive axle | ⑩ 1st wheel gear | ⑲ 5th pinion gear |
| ② Stopper ring | ⑪ 6th wheel gear | ⑳ 2nd pinion gear |
| ③ Bearing | ⑫ Circlip | ㉑ Bearing holder |
| ④ Oil seal | ⑬ 3rd wheel gear | ㉒ Stopper ring |
| ⑤ O-ring | ⑭ 4th wheel gear | ㉓ Bearing |
| ⑥ Collar | ⑮ 5th wheel gear | ㉔ Main axle |
| ⑦ Drive sprocket | ⑯ 2nd wheel gear | ㉕ Oil seal |
| ⑧ Stopper ring | ⑰ 6th pinion gear | ㉖ Circlip |
| ⑨ Bearing | ⑱ 3rd/4th pinion gear | |

**A AXLE RUNOUT LIMIT:
0.08 mm (0.003 in)**

Oil seal ㉕ and circlip ㉖ are available as service parts for oil seal ④.
Use of ㉕ and ㉖ saves trouble of splitting crankcase for oil seal replacement. This applies to ④ only.

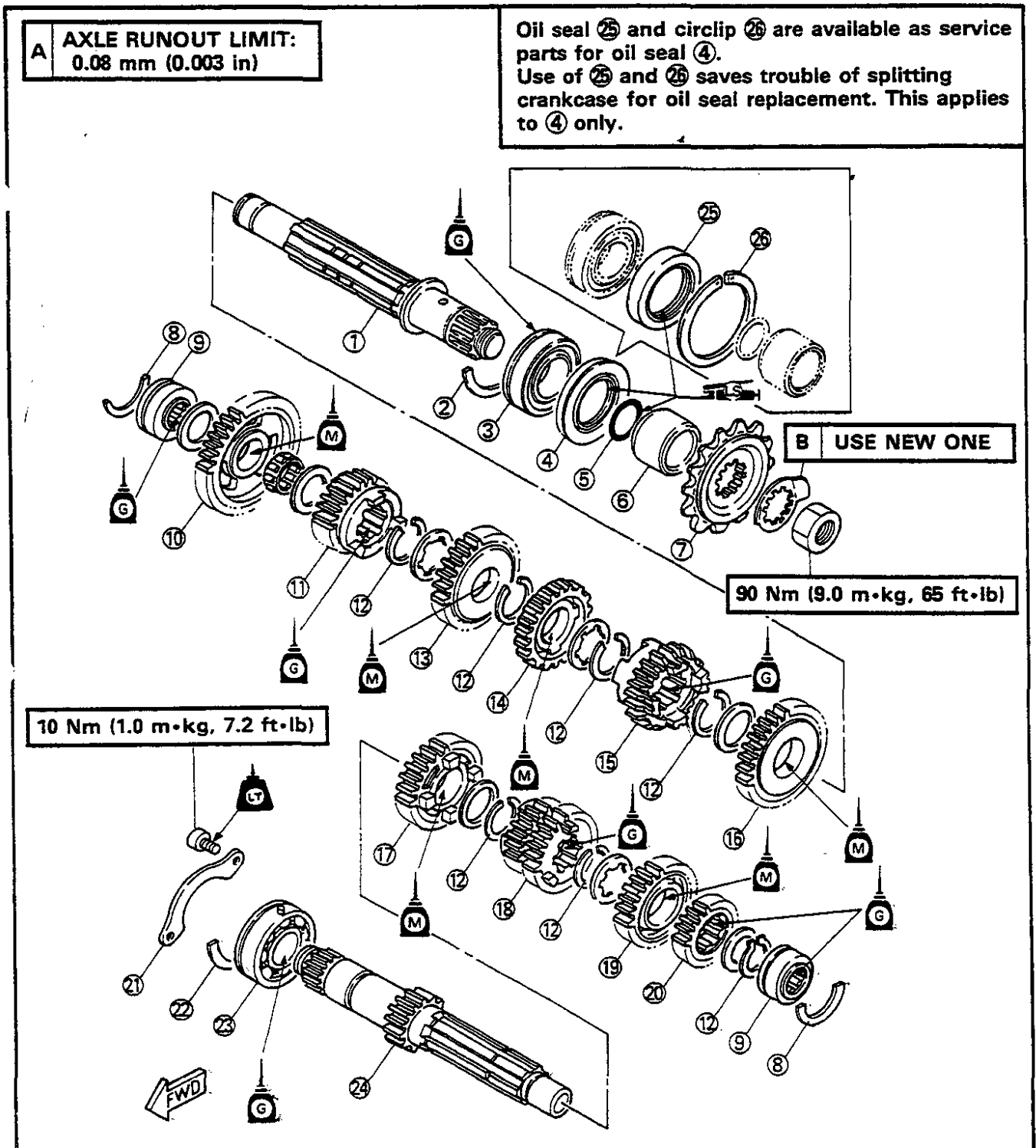

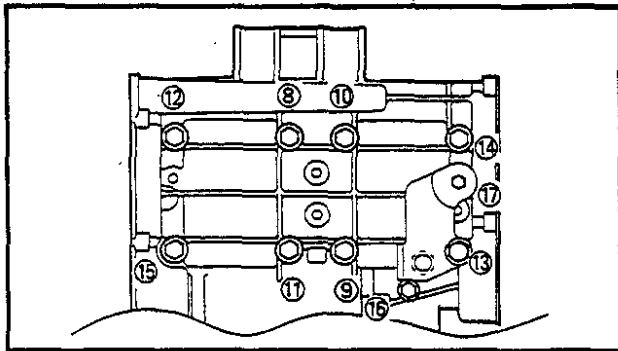
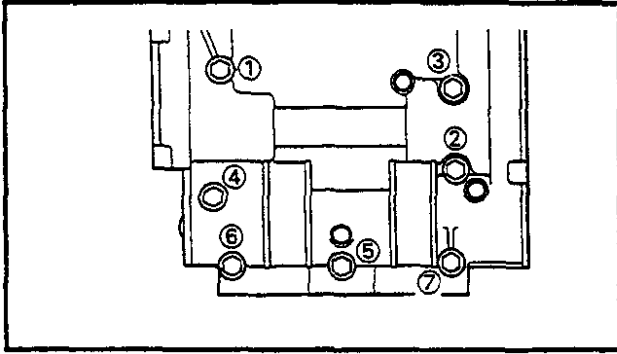

CRANKCASE (UPPER)

1. Install:

- Crankcase (Upper)
- Engine stay

Bolts tightening steps:

- Temporarily tighten ① to ⑦ and next ⑧ to ⑰, in that order.
- Tighten ① to ⑦.



5 Nm (0.5 m•kg, 3.6 ft•lb)

- Tighten ⑧ to ⑮ and ⑰.



10 Nm (1.0 m•kg, 7.2 ft•lb)

- Tighten ⑧ to ⑮.



24 Nm (2.4 m•kg, 17 ft•lb)

- Tighten ① to ⑦ and ⑰.



10 Nm (1.0 m•kg, 7.2 ft•lb)

- Tighten ⑰.



35 Nm (3.5 m•kg, 25 ft•lb)

NOTE:

Install the clamp ① on the bolt No. 4 and the clamp ② on the bolt No. 7 as shown.

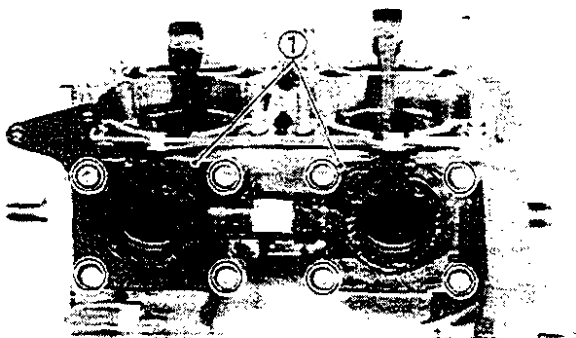
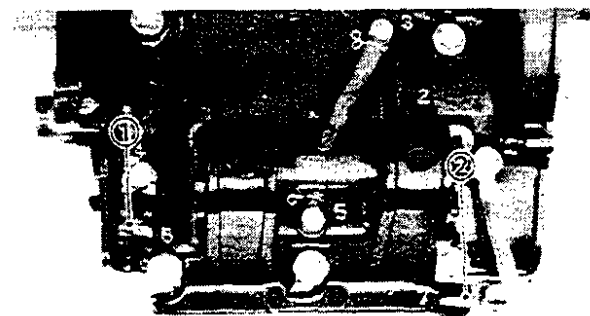

2. Install:

- Gaskets
- Spacers
- Reed valves
- Intake manifolds ①



Bolts (Intake Manifold):
10 Nm (1.0 m•kg, 7.2 ft•lb)

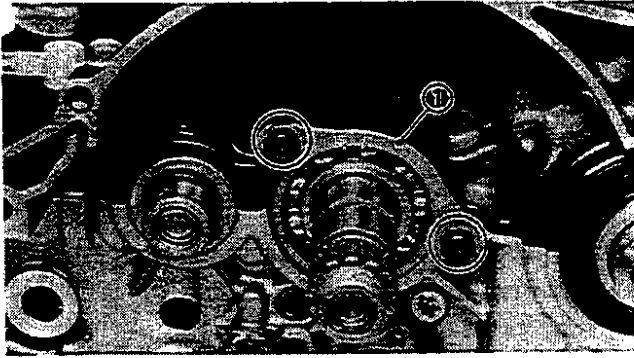

3. Install:

- Bearing holder ①



Bolts (Bearing Holder):
 10 Nm (1.0 m•kg, 7.2 ft•lb)
 Use LOCTITE®.

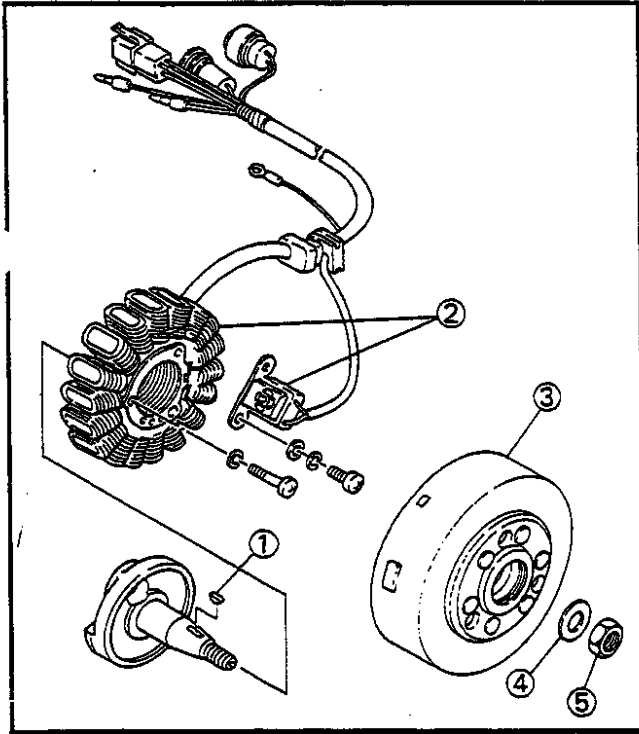

CDI MAGNETO

1. Install:

- Woodruff key ①
- Stator coil assembly ②
- Rotor ③
- Washer ④
- Nut ⑤ (Rotor)



Screws (Stator Coil):
 7 Nm (0.7 m•kg, 5.1 ft•lb)
 Use LOCTITE®.

Screws (Pickup Coil):
 5 Nm (0.5 m•kg, 3.6 ft•lb)
 Use LOCTITE®.

Nut (Rotor):
 80 Nm (8.0 m•kg, 58 ft•lb)

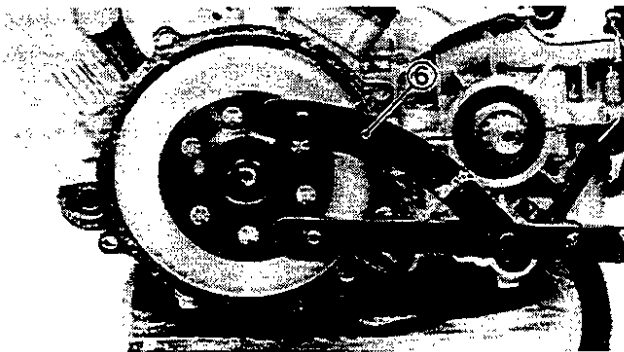

NOTE:

- When installing the rotor, make sure the woodruff key is properly seated in the key way of the crankshaft. Apply a light coating of lithium soap base grease to the tapered portion of the crankshaft end.
- Hold the rotor to tighten the nut (Rotor) by the Universal Rotor Holder ⑥.

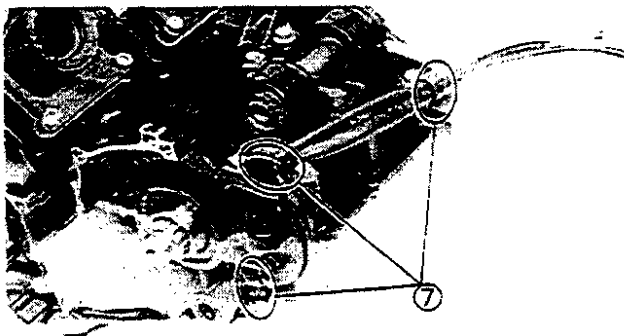

Universal Rotor Holder:
 90890-01235

NOTE:

- Clamp the CDI magneto leads with the clamps ⑦.

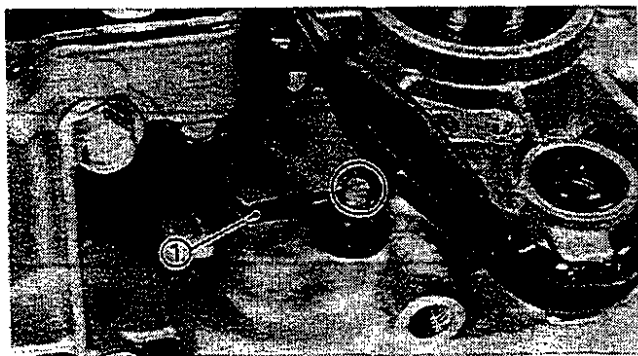

2. Connect:

- Neutral switch lead ①



DI MAGNETO

- ① Stator coil
- ② Pickup coil
- ③ Rotor

A	STATOR COIL RESISTANCE: 0.44~0.66Ω at 20°C (68°F) (White—White)
B	PICKUP COIL RESISTANCE: 188~282Ω at 20°C (68°F) (White/Green—White/Black)

C	SOURCE COIL (1) RESISTANCE: 128~193Ω at 20°C (68°F) (Green—Brown)
	SOURCE COIL (2) RESISTANCE: 3.6~5.4Ω at 20°C (68°F) (Brown—Red)

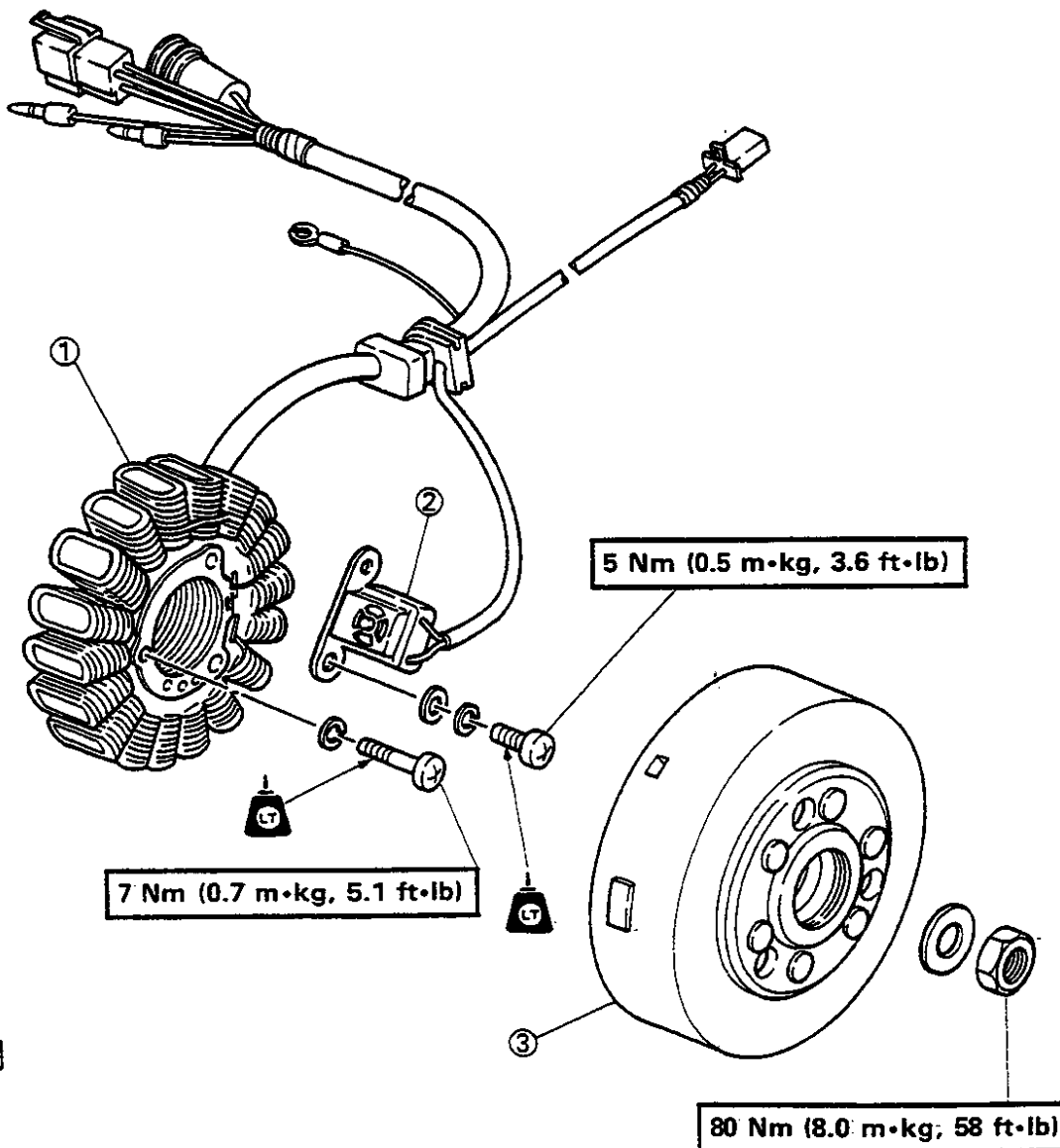

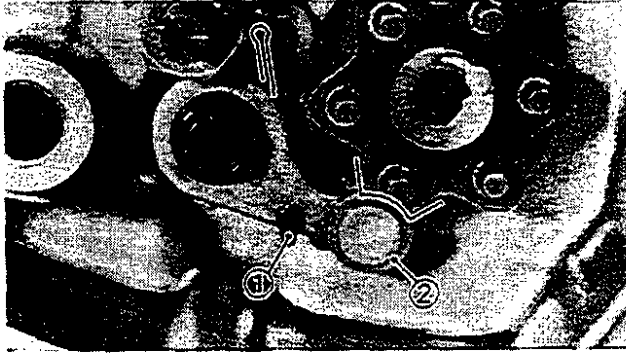

SHIFT SHAFT

1. Install:

- Return spring ①
- Stopper lever ②



Bolt (Stopper Lever):
 10 Nm (1.0 m·kg, 7.2 ft·lb)
 Use LOCTITE®.

NOTE:

Mesh the stopper lever with the shift cam.

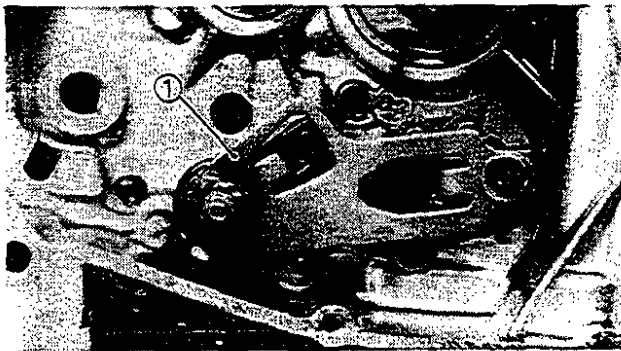

2. Install:

- Shift shaft ①

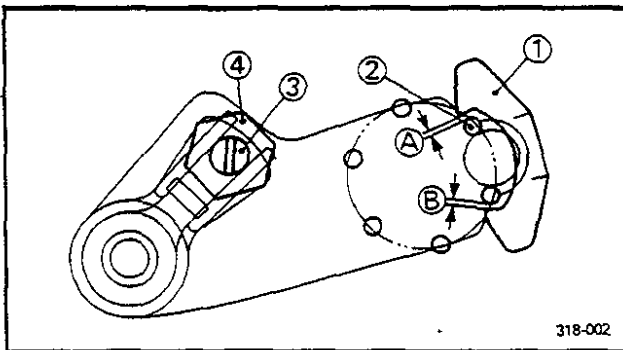

3. Check

- Change lever position
 Gap A and B are not equal → Adjust.

Change lever position adjustment steps:

- Straighten lock washer tab.
- Loosen locknut ④.
- Turn adjuster ③ in or out until gap A and B are equal.
- Tighten locknut.



Nut:
 30 Nm (3.0 m·kg, 22 ft·lb)
 Use LOCTITE®.

- Bend lock washer tab.

- ① Change lever
- ② Segment



SHIFT SHAFT AND SHIFT PEDAL

- ① Shift shaft
- ② Spacer
- ③ Torsion spring
- ④ Oil seal
- ⑤ Shift arm
- ⑥ Shift rod
- ⑦ Shift pedal

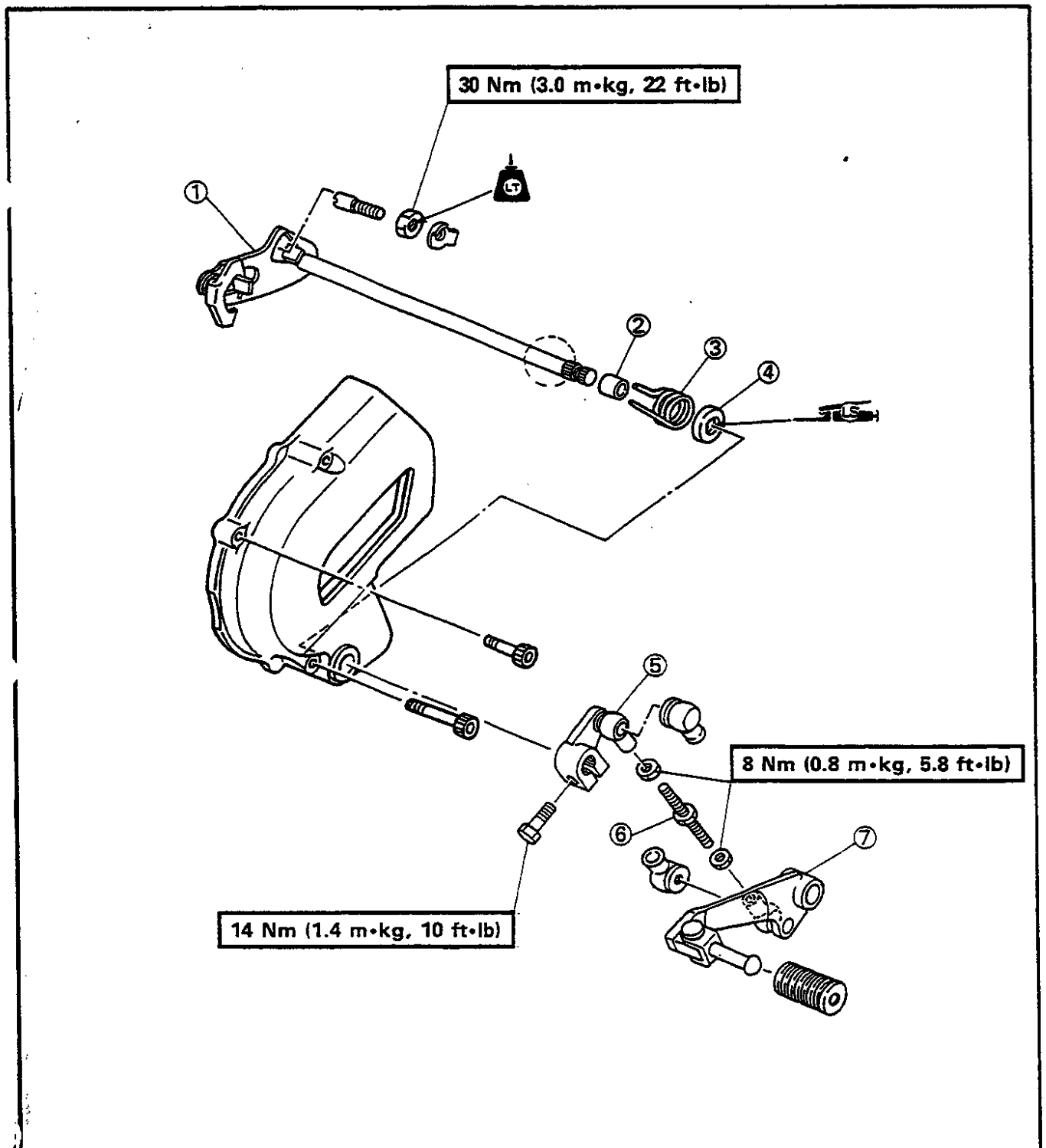

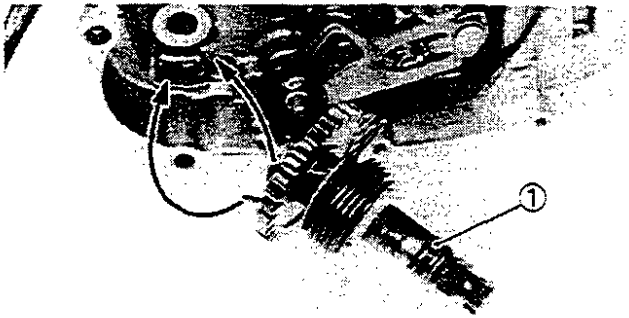

KICK AXLE AND KICK IDLE GEAR

1. Install:

- Kick axle assembly ①

NOTE:

- Make sure that the kick stopper is stopped at the projection of the crankcase.
- Make sure that the kick clip is engaged with the crankcase hole.

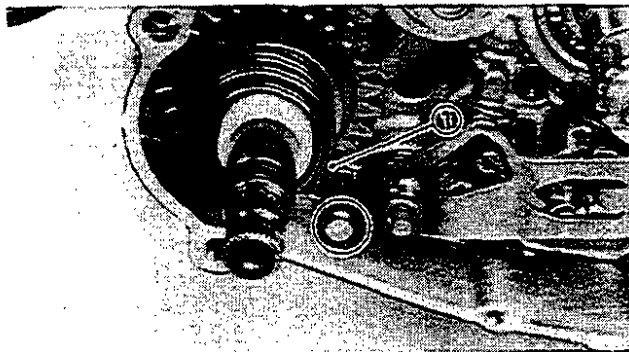

2. Set the kick spring ① to the spring hook.

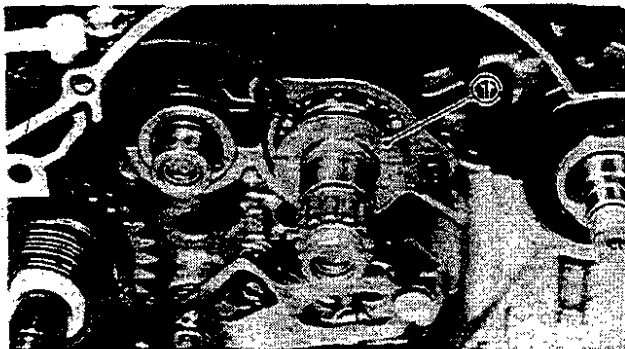

3. Install:

- Thrust washer ① (Clutch housing)

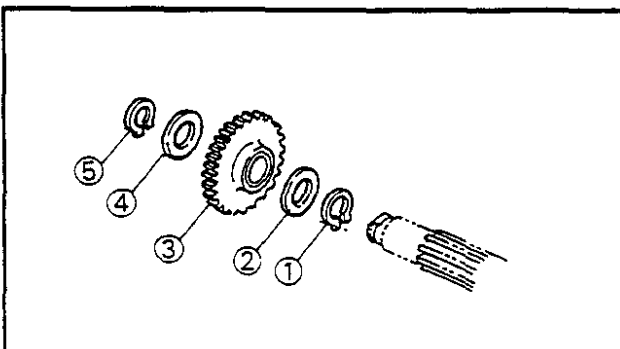

4. Install:

- Circlip ①
- Washer ②
- Kick idle gear ③
- Washer ④
- Circlip ⑤



KICK AXLE AND KICK IDLE GEAR

- | | |
|--------------|------------------|
| ① Kick crank | ⑦ Kick clip |
| ② Oil seal | ⑧ Kick axle |
| ③ Spacer | ⑨ Stopper |
| ④ Spring | ⑩ Circlip |
| ⑤ Washer | ⑪ Washer |
| ⑥ Kick gear | ⑫ Kick idle gear |

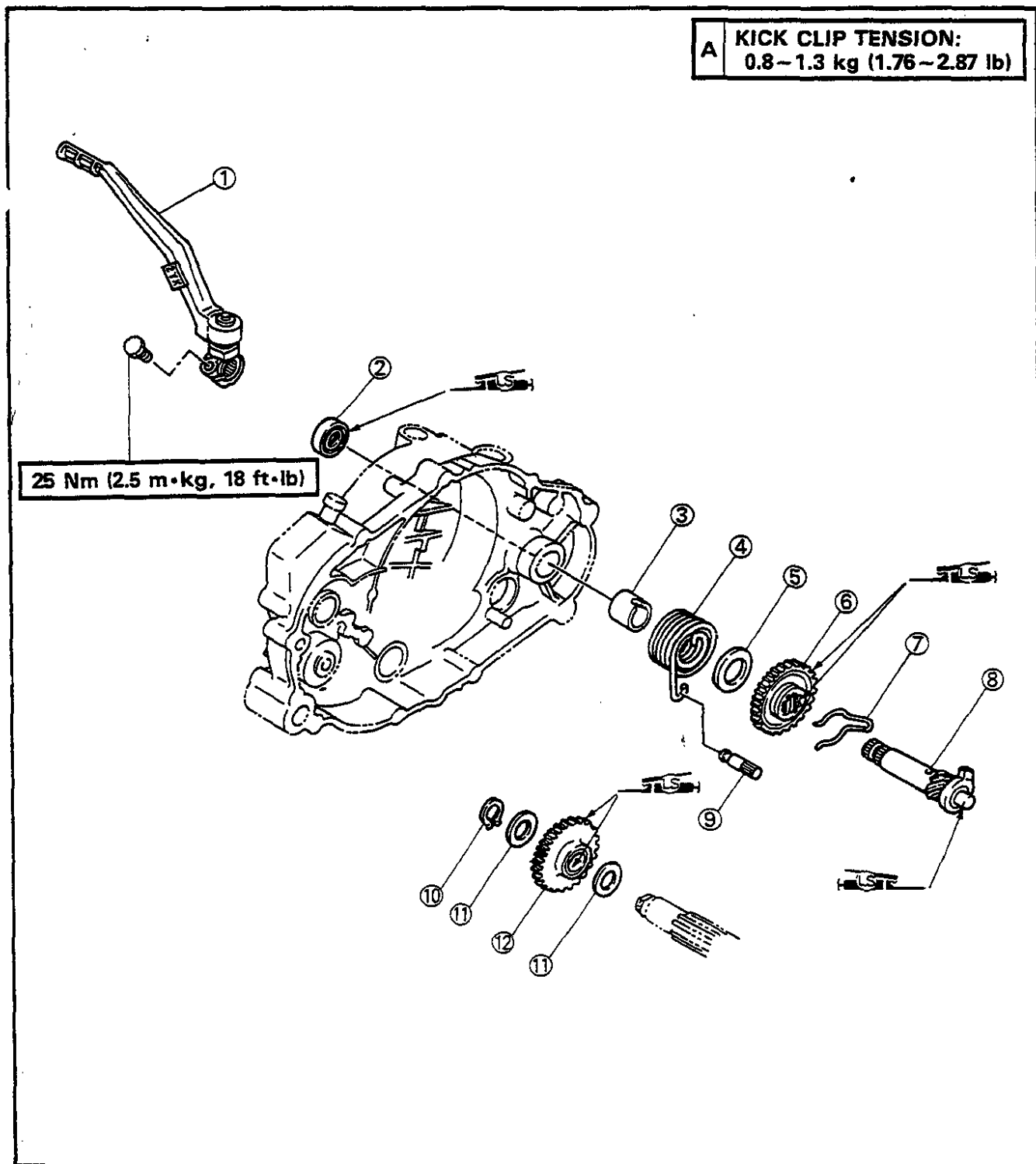

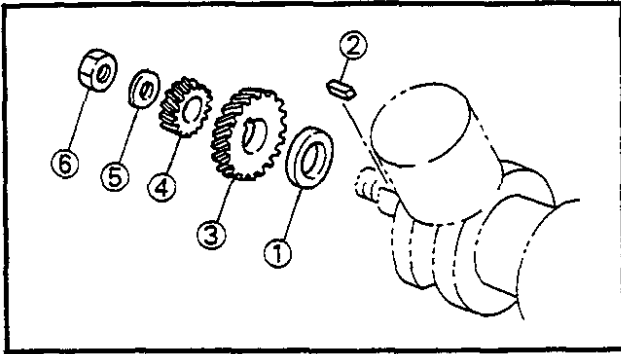

PRIMARY DRIVE GEAR

1. Install:

- Spacer ①
- Key ②
- Primary drive gear ③
- Drive gear ④ (Water pump)
- Conical spring washer ⑤
- Nut ⑥ (Primary drive gear)

NOTE:

Hold the rotor to tighten the nut (Primary drive gear) by the Universal Rotor Holder ⑦.

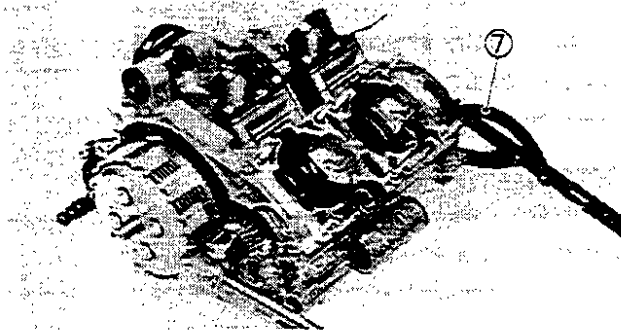

Universal Rotor Holder:
90890-01235



Nut (Primary Drive Gear):
65 Nm (6.5 m•kg, 47 ft•lb)

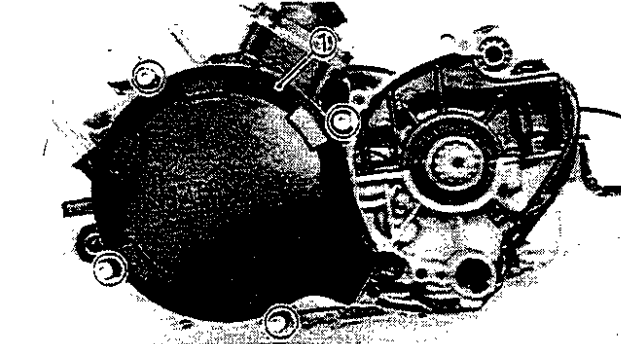

2. Install:

- AC generator cover ①



Bolts (AC Generator Cover):
5 Nm (0.5 m•kg, 3.6 ft•lb)

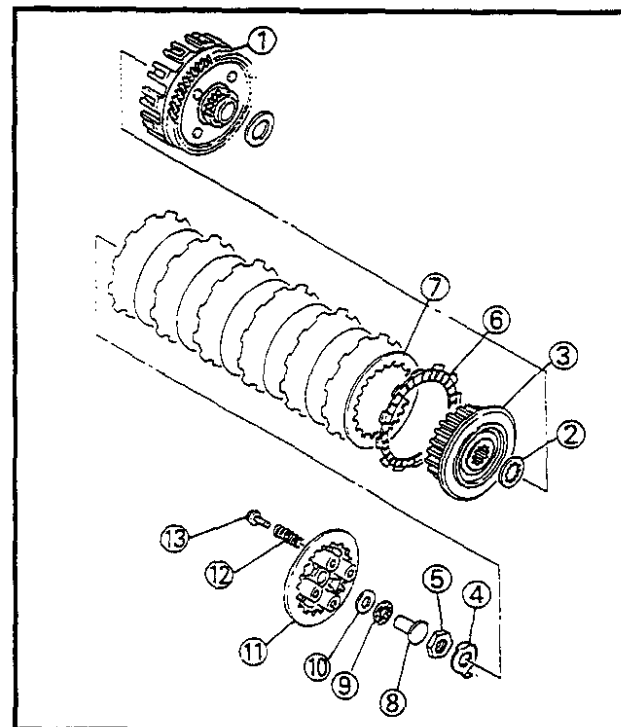

CLUTCH

1. Install:

- Clutch housing ①
- Thrust washer ②
- Clutch boss ③
- Lock washer ④
- Nut ⑤ (Clutch boss)
- Friction plate ⑥
- Clutch plate ⑦
- Pull rod ⑧
- Bearing ⑨ (Pull rod)
- Washer ⑩
- Pressure plate ⑪
- Clutch spring ⑫
- Bolt ⑬ (Pressure plate)



Nut (Clutch Boss):
 90 Nm (9.0 m•kg, 65 ft•lb)
Bolts (Pressure Plate):
 7 Nm (0.7 m•kg, 5.1 ft•lb)

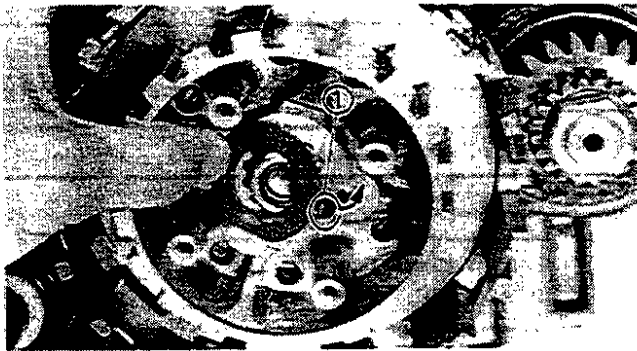

NOTE: _____
 Install the lock washer tab ① into the hole of the clutch boss.

WARNING: _____

Always use a new lock washer.

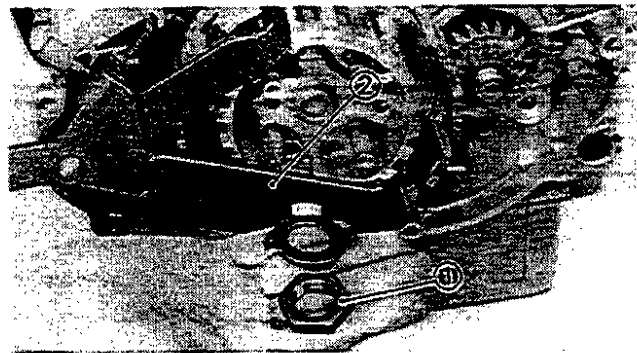

NOTE: _____
 • Hold the clutch boss to tighten the nut ① by the Universal Clutch Holder ②.
 • After tightening the nut (Clutch boss), bend the lock washer tab along the nut flats.



Universal Clutch Holder:
 90890-04086

NOTE: _____
 Apply a gear oil to the bearing ①.

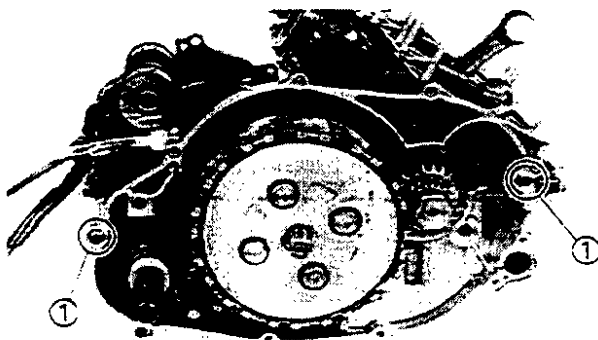
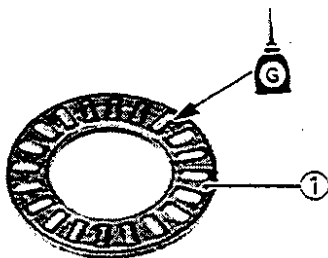

2. Install:
 • Dowel pins ①
 • Gasket (Crankcase cover)

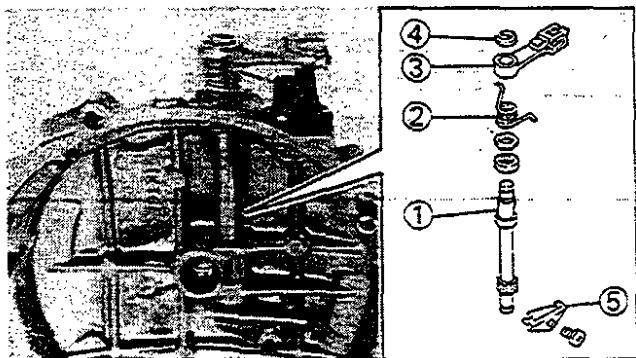

3. Apply:
- Lithium soap base grease
To oil seal (Pull rod).

4. Install:
- Pull rod ①
 - Spring ②
 - Pull rod lever ③
 - Circlip ④
 - Holder ⑤



Screw (Holder):
 10 Nm (1.0 m•kg, 7.2 ft•lb)
 Use LOCTITE®.

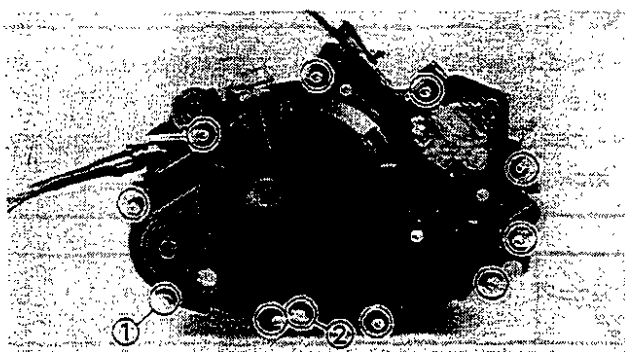

5. Install:
- Crankcase cover (Right)



Screws (Crankcase Cover):
 10 Nm (1.0 m•kg, 7.2 ft•lb)
Drain Bolt ① (M10):
 22 Nm (2.2 m•kg, 16 ft•lb)
Drain Bolt ② (M8):
 16 Nm (1.6 m•kg, 11 ft•lb)

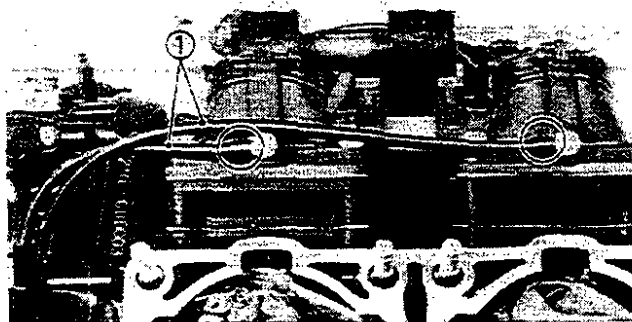

6. Connect:
- Oil delivery hoses ①

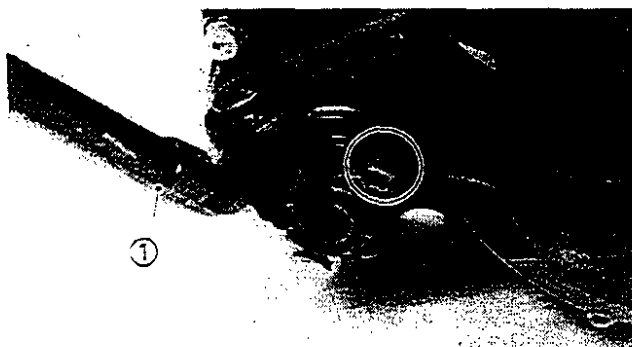

7. Install:
- Kick crank ①



Bolt (Kick Crank):
 25 Nm (2.5 m•kg, 18 ft•lb)



CLUTCH AND PRIMARY DRIVE GEAR

- ① Primary drive gear
- ② Spacer
- ③ Key
- ④ Thrust washer
- ⑤ Clutch housing
- ⑥ Thrust washer
- ⑦ Clutch boss
- ⑧ Friction plate
- ⑨ Clutch plate
- ⑩ Pull rod
- ⑪ Bearing
- ⑫ Washer
- ⑬ Pressure plate
- ⑭ Circlip
- ⑮ Pull lever
- ⑯ Spring
- ⑰ Oil seal
- ⑱ Lever rod

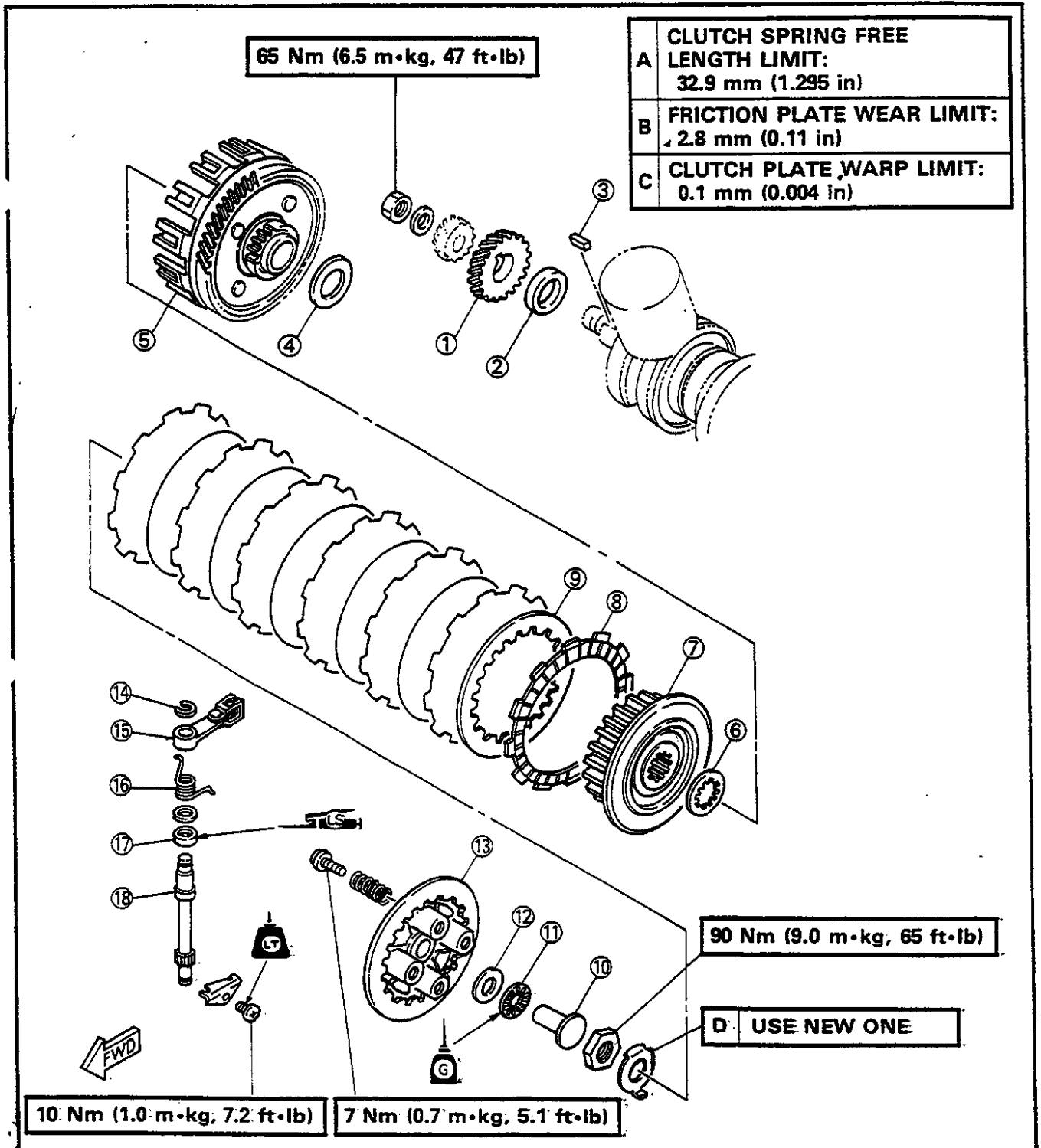

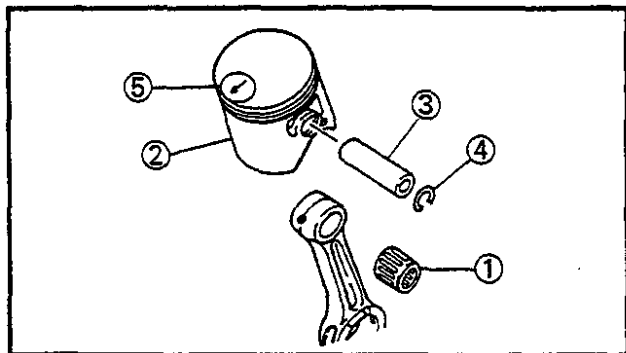

CYLINDER HEAD, CYLINDERS AND PISTONS

1. Apply:
 - Engine oil
To the small end bearing and big end bearing.
2. Install:
 - Small end bearing ①
 - Piston ②
 - Piston pin ③
 - Circlip ④

NOTE:

- The arrow ⑤ on the piston must point to the front of the engine.
- Before installing the piston pin clip, cover the crankcase with a clean towel or rag so you will not accidentally drop the pin clip and material into the crankcase.

WARNING:

Always use a new piston pin clip.

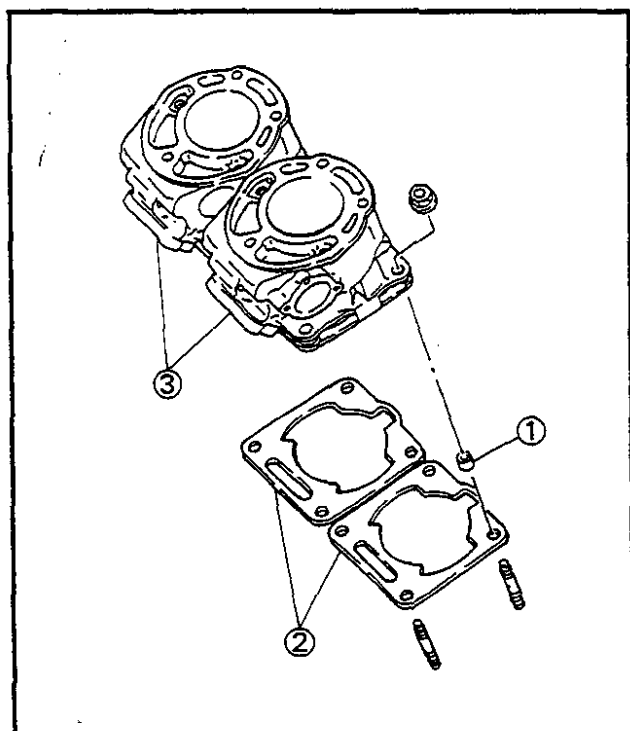

3. Install:

- Dowel pin ①
- Gasket ② (Cylinder)
- Cylinder ③



Nuts (Cylinder):

28 Nm (2.8 m•kg, 20 ft•lb)

NOTE:

Tighten the nuts in stage, using a crisscross pattern.

NOTE:

Make sure the ring ends ④ are properly fitted around the ring locating pins in the piston grooves.

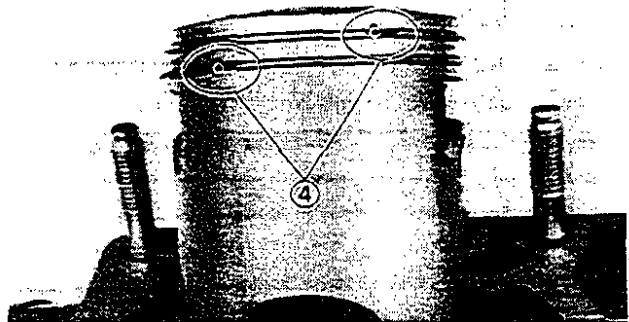

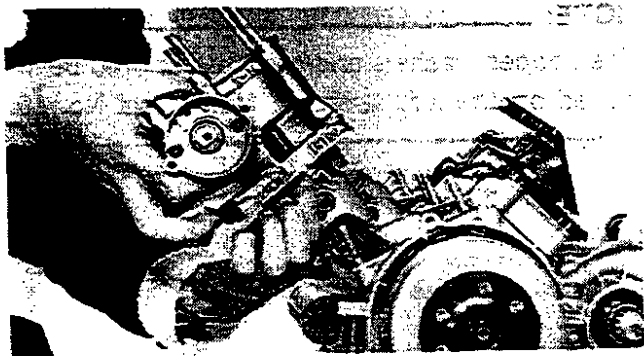

NOTE:

Install the cylinder with one hand while compressing the piston rings with the other hand.

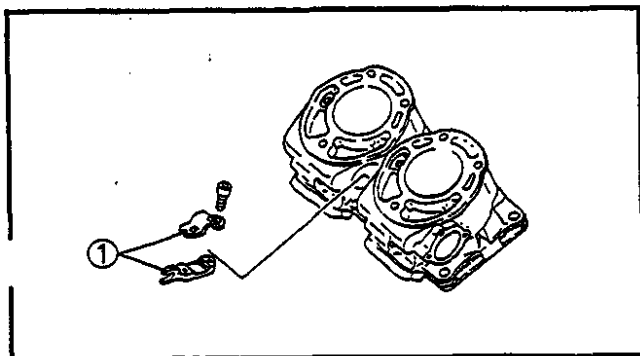

4. Install:

- Joint ① (Power valve)

	<p>Screws (Joint): 7 Nm (0.7 m•kg, 5.1 ft•lb)</p>
---	--

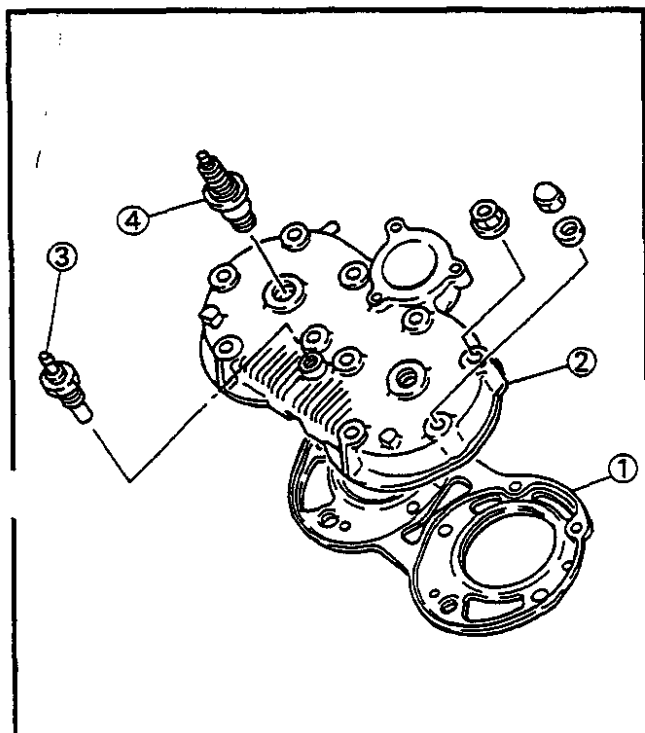

5. Install:

- Gasket ① (Cylinder head)
- Cylinder ②
- Thermo unit ③
- Spark plug ④

	<p>Nuts (Cylinder Head): 22 Nm (2.2 m•kg, 16 ft•lb)</p> <p>Spark Plugs: 20 Nm (2.0 m•kg, 14 ft•lb)</p> <p>Thermo Unit: 15 Nm (1.5 m•kg, 11 ft•lb)</p> <p>Use Water Resistant Sealant.</p>
---	---

NOTE:

The nuts (Cylinder head) should be tightened in the order of numbers and in two steps.

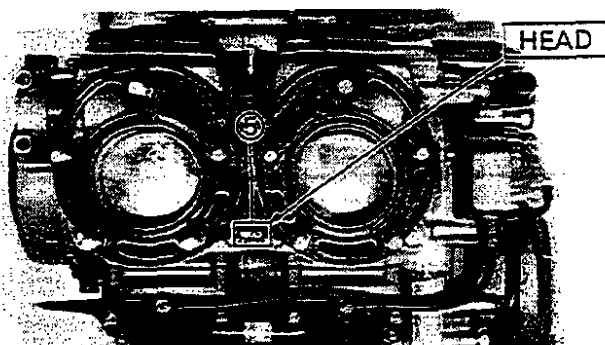

WARNING:

Handle the thermo unit with special care. Never subject it to strong or allow it to be dropped. Should it be dropped, it must be replaced.

NOTE:

Install the gasket (Cylinder head) with the "HEAD" mark ⑤ faced upward.

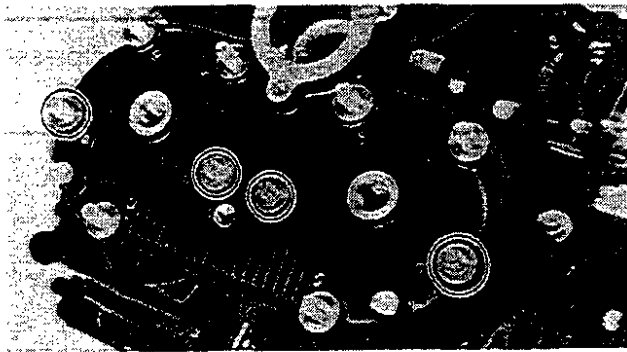

NOTE:

The copper washers and cap nuts should be installed on the No. 1, No. 4, No. 9 and No. 10.

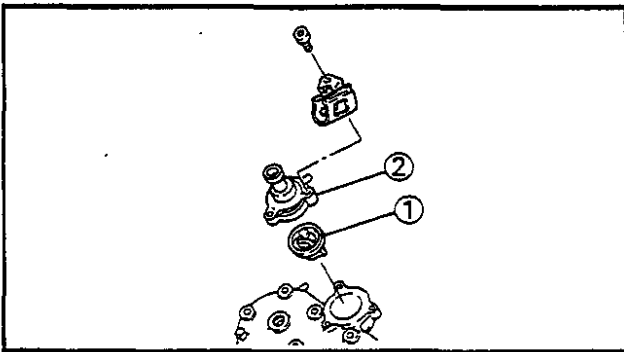

6. Install:

- Thermostatic valve ①
- Cover ② (Thermostatic valve)



Bolts (Cover):

10 Nm (1.0 m•kg, 7.2 ft•lb)



CYLINDER AND CYLINDER HEAD

- ① Spark plug
- ② Copper washer
- ③ Cylinder head
- ④ Gasket
- ⑤ Cylinder (Right-hand)
- ⑥ Cylinder (Left-hand)
- ⑦ Gasket
- ⑧ Dowel pin

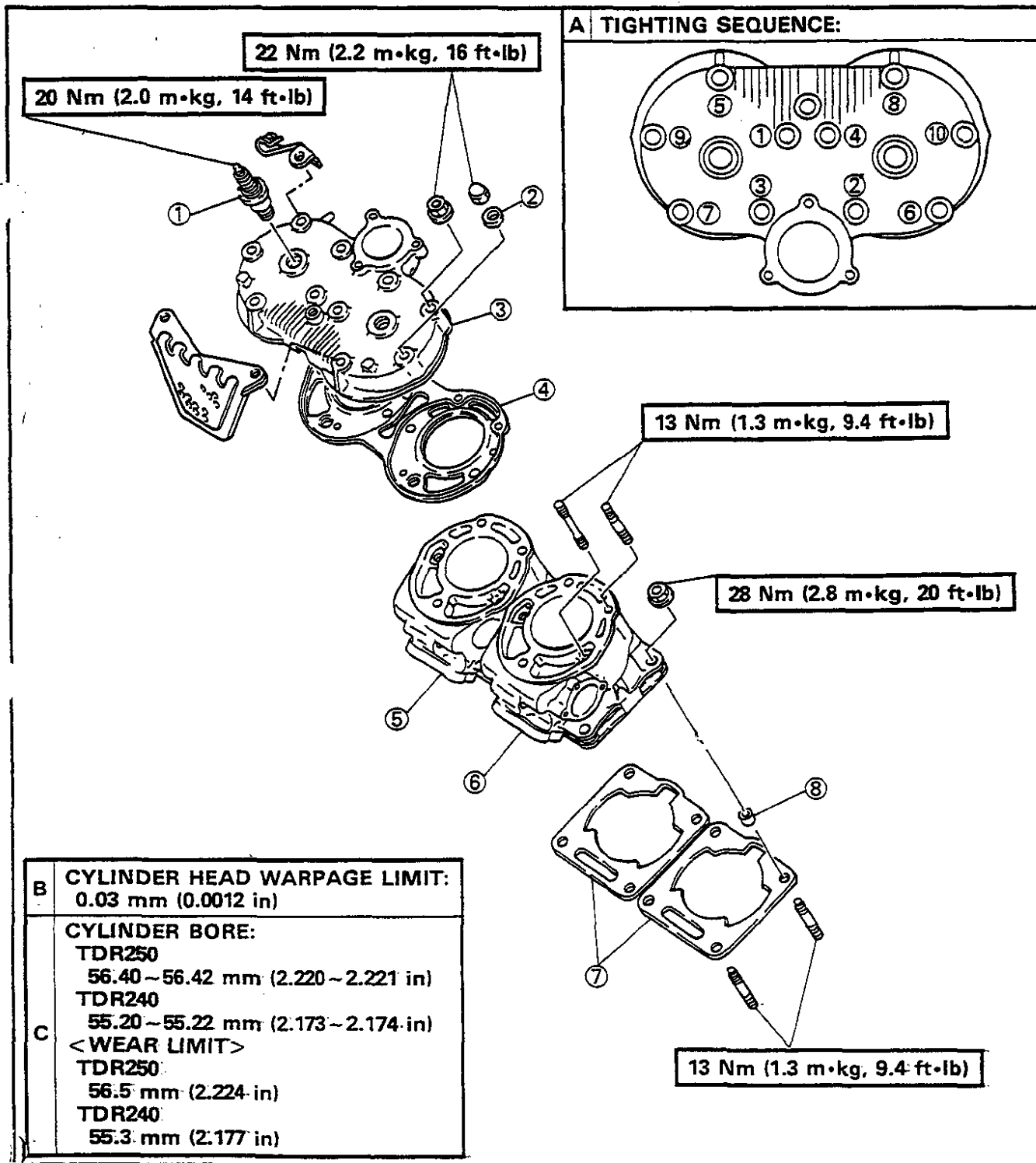



REMounting ENGINE

Reverse the "ENGINE REMOVAL" procedure.
Note the following points.

1. Install:
 - Engine assembly

NOTE:

Temporarily tighten the bolts and nuts before tightening them to specification.



Nut (Engine Mount—Front):
55 Nm (5.5 m•kg, 40 ft•lb)
Nut (Engine Mount—Rear):
55 Nm (5.5 m•kg, 40 ft•lb)
Bolt (Engine Stay—Rear):
25 Nm (2.5 m•kg, 18 ft•lb)
Bolt (Torque Rod Stay):
45 Nm (4.5 m•kg, 32 ft•lb)
Bolt (Torque Rod):
45 Nm (4.5 m•kg, 32 ft•lb)

2. Tighten:
 - Nut (Drive sprocket)



Nut (Drive Sprocket):
90 Nm (9.0 m•kg, 65 ft•lb)

NOTE:

Bend the lock washer tab along the nut flats.

WARNING:

Always use a new lock washer.

3. Adjust:
 - Drive chain slack



Drive Chain Slack:
20 – 30 mm (0.8 – 1.2 in)

Refer to "DRIVE CHAIN SLACK ADJUSTMENT" section in CHAPTER 3.



4. Tighten:

- Bolt (Crankcase cover—Left)
- Bolt (Shift arm)



Bolt (Crankcase Cover—Left):
 5 Nm (0.5 m•kg, 3.6 ft•lb)
Bolt (Shift Arm):
 14 Nm (1.4 m•kg, 10 ft•lb)

5. Tighten:

- Bolt (Radiator)



Bolt (Radiator):
 6 Nm (0.6 m•kg, 4.3 ft•lb)

6. Tighten:

- Bolt (Pulley housing)



Bolt (Pulley Housing):
 7 Nm (0.7 m•kg, 5.1 ft•lb)

7. Tighten:

- Bolt (Power valve pulley)



Bolt (Power Valve Pulley):
 10 Nm (1.0 m•kg, 7.2 ft•lb)

8. Adjust:

- YPVS cables

NOTE:

Before adjusting the YPVS cables, turn the main switch to "ON" and operate the YPVS motor.

Refer to "YPVS CABLE ADJUSTMENT" section in CHAPTER 3.

9. Tighten:

- Bolt (Pulley cover)



Bolt (Pulley Cover):
 7 Nm (0.7 m•kg, 5.1 ft•lb)

10. Adjust:

- Clutch cable



Free Play:
 10–15 mm (0.4–0.6 in)
 At Lever End.

Refer to "CLUTCH ADJUSTMENT" section in CHAPTER 3.



11. Adjust:

- Autolube pump cable

Refer to "AUTOLUBE PUMP CABLE ADJUSTMENT" section in CHAPTER 3.

12. Air bleeding:

- Autolube pump

Refer to "AUTOLUBE PUMP AIR BLEEDING" section in CHAPTER 3.

13. Tighten:

- Bolt (Autolube pump cover)



Bolt (Autolube Pump Cover):
6 Nm (0.6 m•kg, 4.3 ft•lb)

14. Tighten:

- Nut (Exhaust pipe)
- Bolt (Muffler—Front)
- Bolt (Muffler—Rear)



Nut (Exhaust Pipe):
18 Nm (1.8 m•kg, 13 ft•lb)
Bolt (Muffler—Front):
9 Nm (0.9 m•kg, 6.5 ft•lb)
Bolt (Muffler—Rear):
38 Nm (3.8 m•kg, 27 ft•lb)

15. Fill:

- Coolant



Total Amount:
1.45 L (1.27 Imp qt, 1.53 US qt)

Refer to "COOLANT REPLACEMENT" section in CHAPTER 3.

16. Fill:

- Transmission oil



Total Amount:
1.0 L (0.9 Imp qt, 1.1 US qt)

Refer to "TRANSMISSION OIL REPLACEMENT" section in CHAPTER 3.



COOLING SYSTEM

WATER PUMP

- ① Water pump housing cover
- ② Gasket
- ③ Impeller shaft
- ④ Oil seal
- ⑤ Impeller shaft gear
- ⑥ Impeller shaft drive gear

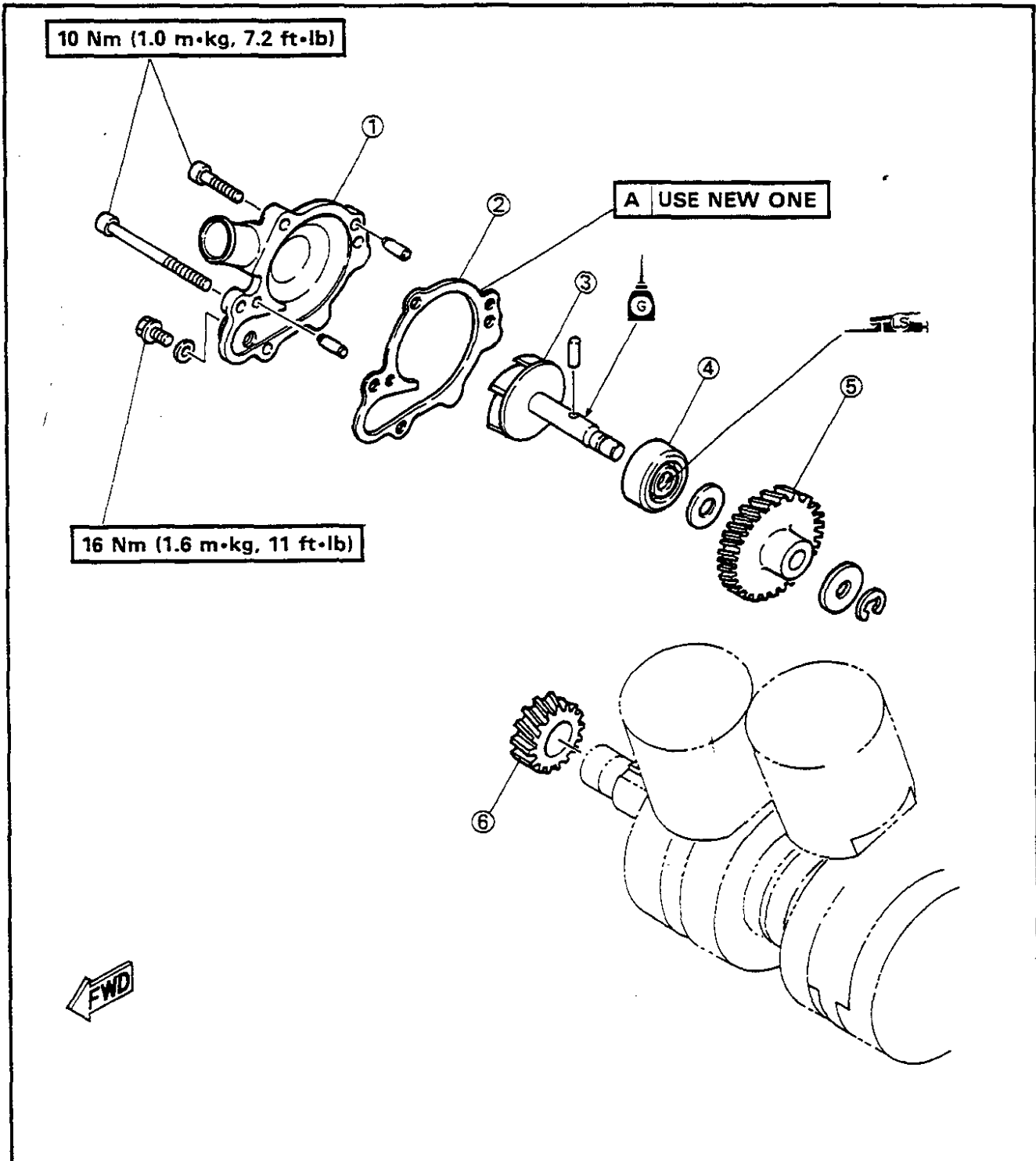



REMOVAL

NOTE: _____

It is necessary to disassemble the water pump, unless there is no abnormality such as excessive change in coolant temperature and/or level, discoloration of coolant, or milky transmission oil.

1. Drain:

- Crankcase

Refer to the "TRANSMISSION OIL REPLACEMENT" section in the CHAPTER 3.

- Cooling system

Refer to the "COOLANT REPLACEMENT" section in the CHAPTER 3.

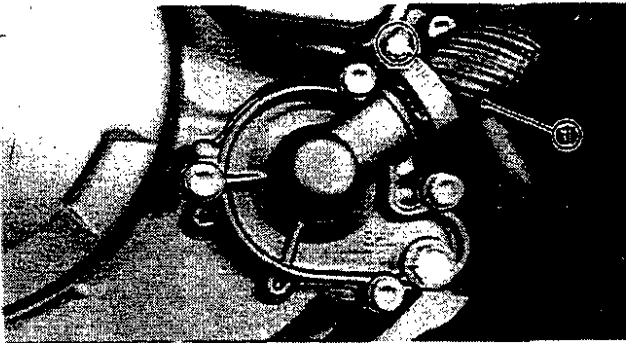

2. Disconnect:

- Outlet hose ①

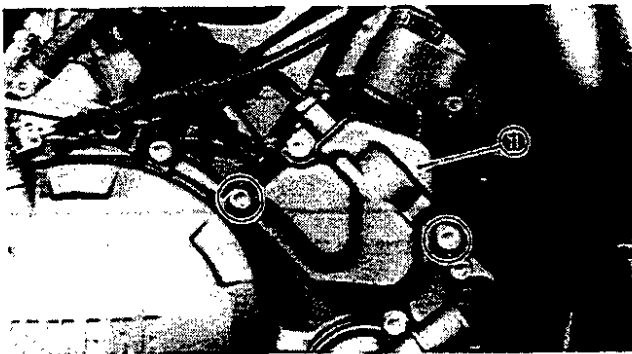

3. Remove:

- Autolube pump cover ①

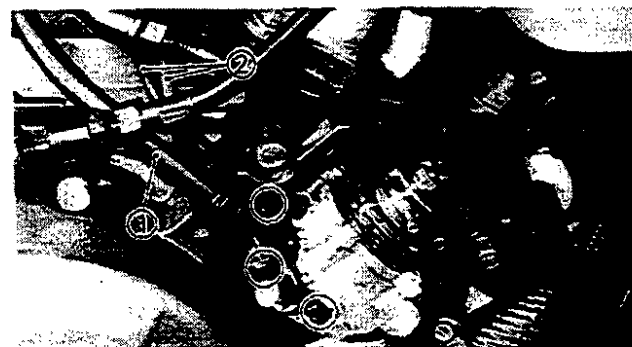

4. Disconnect:

- Oil hose ①
- Oil delivery hoses ②

NOTE: _____

Plug the oil pipe so oil will not run out of oil tank.

WATER PUMP

COOL

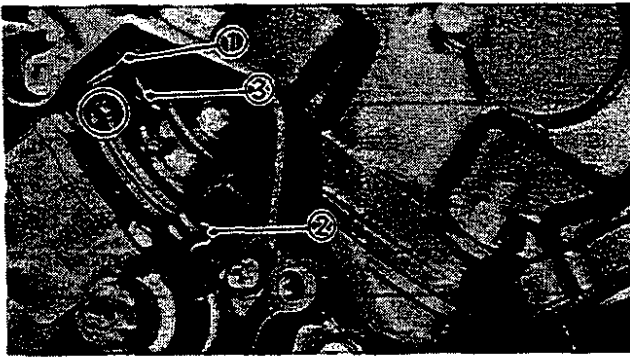

5. Remove:

- Clip ①
- Clip ②
- Autolube pump cable ③

NOTE:

Turn the pump pulley counterclockwise by finger to make the pump cable loose enough for its end to be removed from the pulley.

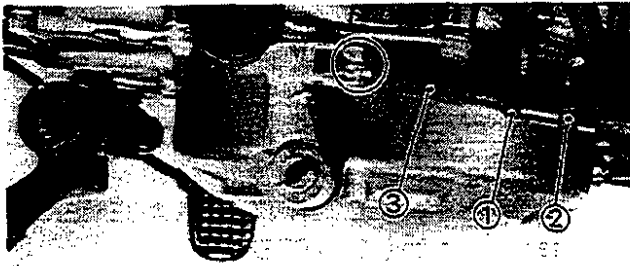

6. Loosen:

- Locknut ① (Clutch cable)
- Adjuster ② (Clutch cable)

7. Remove:

- Clutch cable ③

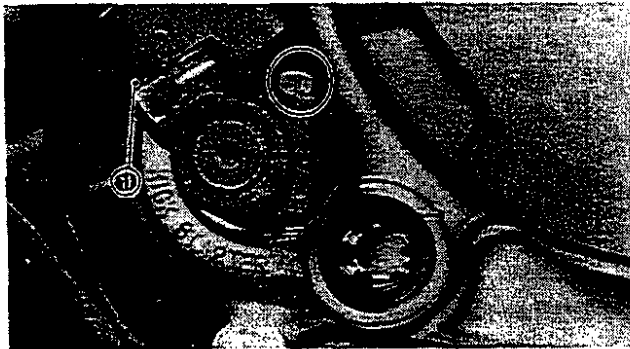

8. Remove:

- Kick crank ①

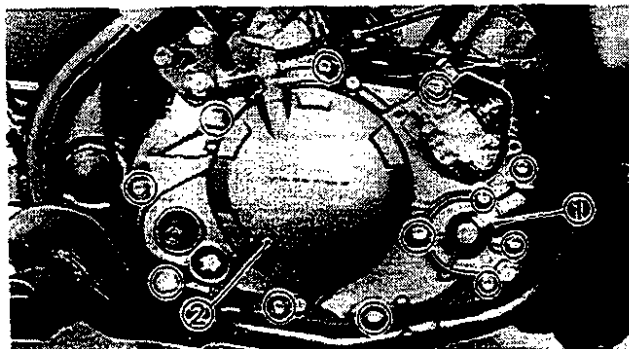

9. Remove:

- Water pump housing cover ①
- Crankcase cover ② (Right)

CAUTION:

Drain the coolant out of the water pump while taking care so that it does not splash to the Autolube pump.

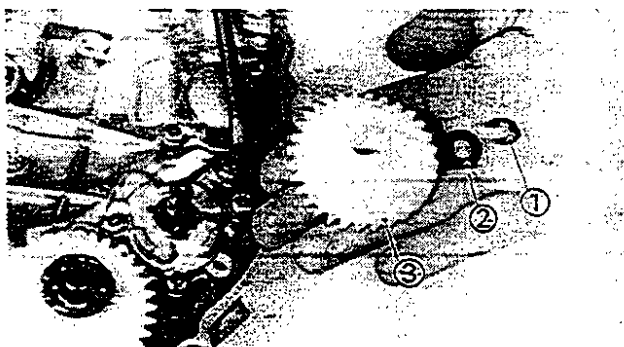

10. Remove:

- Circlip ①
- Plain washer ②
- Impeller shaft gear ③



11. Remove:
 - Pin ①
 - Plain washer ②

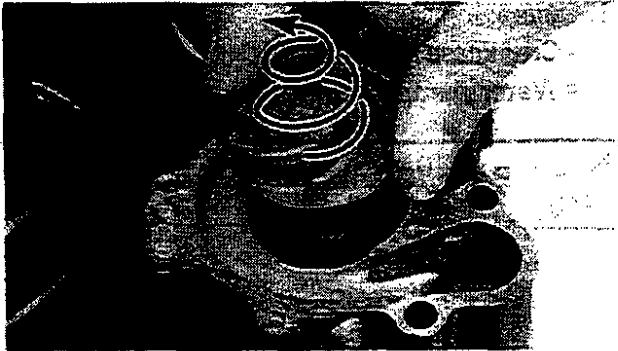

12. Remove:
 - Impeller shaft ①

13. Eliminate deposits from the impeller and water pump housing.

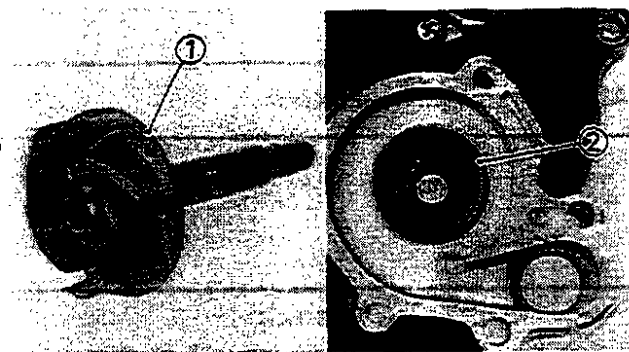

INSPECTION

1. Inspect:
 - Impeller ①
Cracks/Wear/Damage → Replace.
 - Oil seal ②
Wear/Damage → Replace.

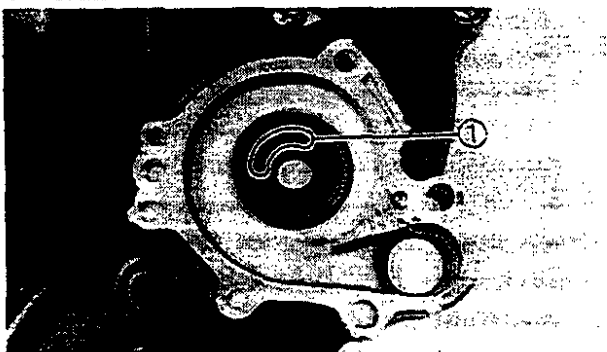

Oil seal replacement steps:

- Remove the oil seal from the crankcase cover by tapping its toward the outside.
- Install the new oil seal with the "WATER SIDE" mark ① on the outside.

NOTE: _____
 Press-fit the oil seal until its contact the bottom.

INSTALLATION

Reverse the "REMOVAL" procedure.
 Note the following points.

1. Apply:
 - Lightweight lithium base grease
To oil seal lips and impeller shaft.

WATER PUMP

COOL

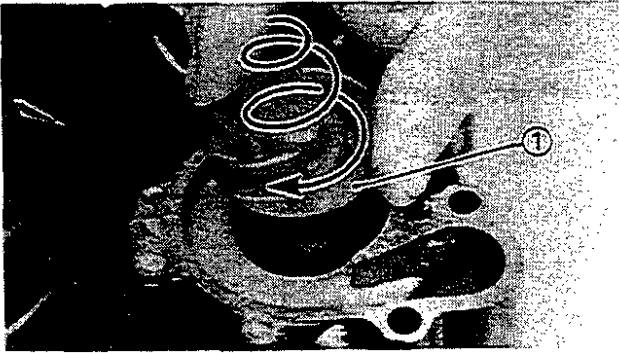

2. Install:

- Impeller shaft ①

Install the shaft while turning it.

NOTE:

Take care so that the oil seal lip is not damaged or the spring does not slip off its position.

3. Install:

- Crankcase cover (Right)
- Water pump housing cover



Bolts (Crankcase Cover):

10 Nm (1.0 m·kg, 7.2 ft·lb)

Bolts (Water Pump Housing Cover):

10 Nm (1.0 m·kg, 7.2 ft·lb)

CAUTION:

Always use new gaskets.

4. Install:

- Kick crank



Bolt (Kick Crank):

25 Nm (2.5 m·kg, 18 ft·lb)

5. Fill:

- Transmission oil

Refer to the "TRANSMISSION OIL REPLACEMENT" section in the CHAPTER 3.

- Coolant

Refer to the "COOLANT REPLACEMENT" section in the CHAPTER 3.

6. Adjust:

- Clutch cable free play



Clutch Cable Free Play:

10 ~ 15 mm (0.4 ~ 0.6 in)

At Lever End.

Refer to the "CLUTCH ADJUSTMENT" section in the CHAPTER 3.



RADIATOR

- ① Outlet hose
- ② Radiator cap
- ③ Coolant breather hose
- ④ Inlet hose
- ⑤ Radiator
- ⑥ Radiator cover

<p>A RADIATOR CAP OPENING PRESSURE: 75 ~ 105 kPa (0.75 ~ 1.05 kg/cm², 10 ~ 14 psi)</p>	<p>B COOLANT CAPACITY: 1.45 L (1.27 Imp qt, 1.53 US qt) Including all routes.</p>
--	--

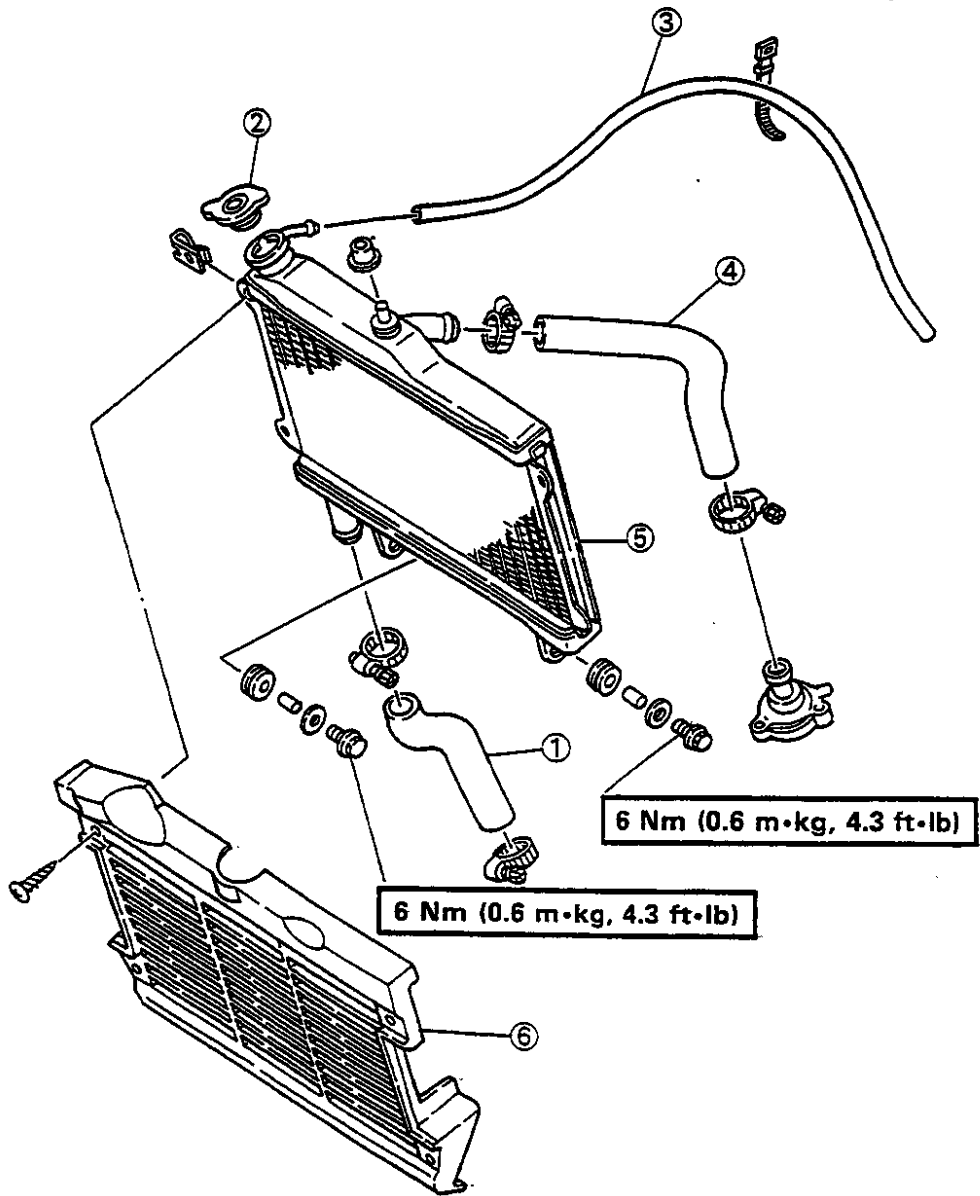



REMOVAL

1. Remove:

- Seat
- Lower cowling
Refer to the "COWLINGS" section in the CHAPTER 3.
- Side cover
Refer to the "SIDE COVERS" section in the CHAPTER 3.

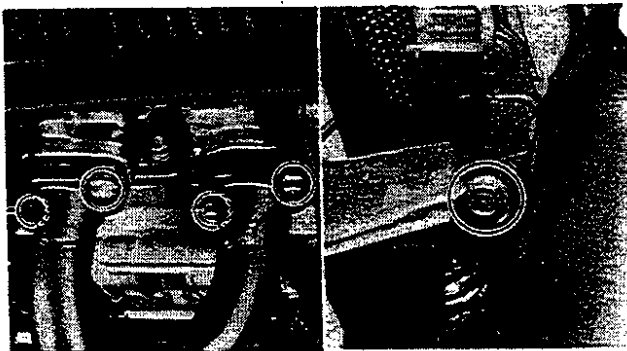

2. Remove:

- Muffler

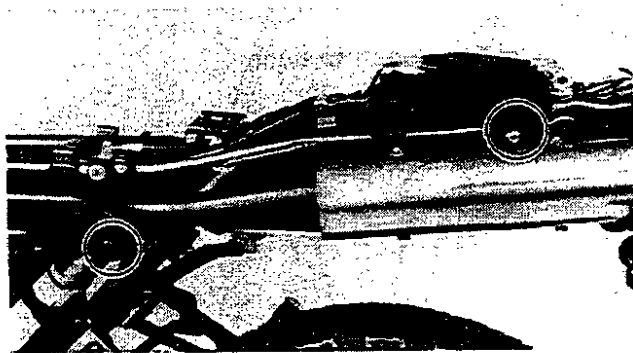

3. Drain:

- Cooling system
Refer to the "COOLANT REPLACEMENT" section in the CHAPTER 3.

NOTE: _____

Thoroughly flush the cooling system with clean tap water.

CAUTION: _____

Take care so that coolant does not splash to painted surfaces. If splashes, wash it away with water.

**WARNING:**

Do not remove the radiator cap, drain bolts and hoses especially when the engine and radiator are hot. Scalding hot fluid and steam may be blown out under pressure, which could cause serious injury. When the engine has cooled, place a thick rag like a towel over the radiator cap, slowly rotate the cap counterclockwise to the detent. This procedure allows any residual pressure to escape. When the hissing sound has stopped, press down on the cap while turning counterclockwise and remove it.

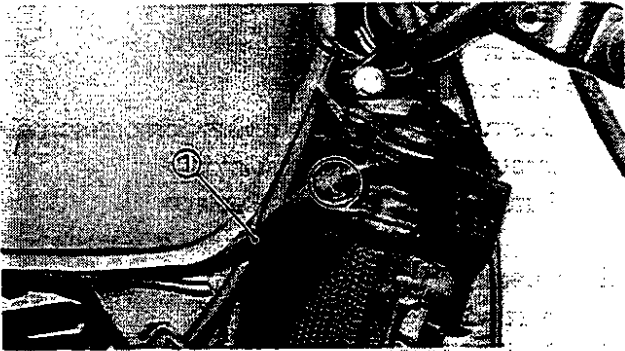

4. Disconnect:

- Coolant breather hose ①

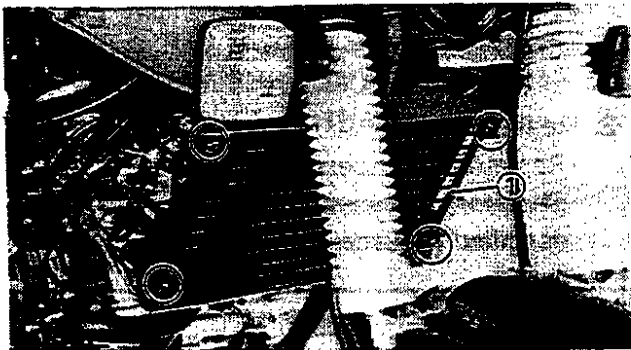

5. Remove:

- Radiator cover ①

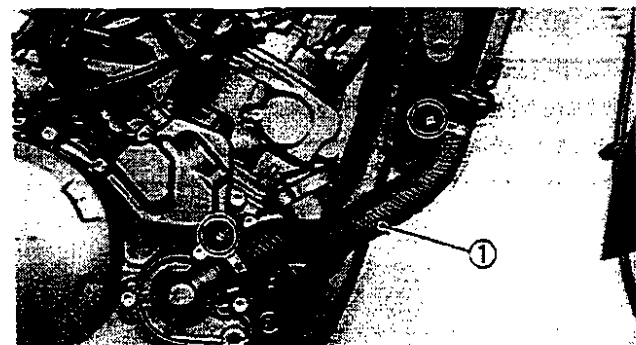

6. Remove:

- Outlet hose ①

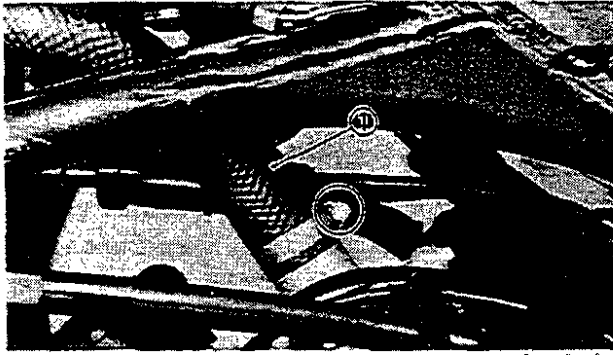

7. Remove:
• Inlet hose ①

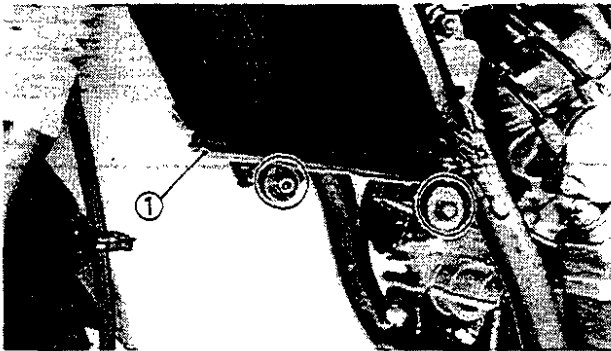

8. Remove:
• Radiator ①

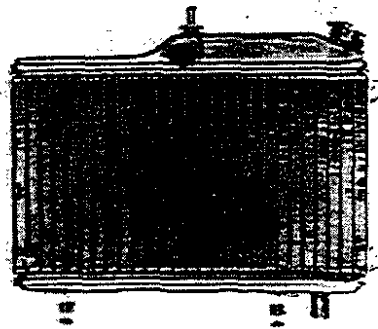

INSPECTION

1. Inspect:
 - Radiator core
 - Obstruction → Blow out with compressed air through rear of the radiator.
 - Flattened fin → Repair/Replace.
2. Inspect:
 - Inlet hose
 - Crack/Damage → Replace.
 - Outlet hose
 - Crack/Damage → Replace.
3. Measure:
 - Radiator cap opening pressure
 - Radiator cap opens at pressure below the specified pressure → Replace.

Valve Opening Pressure:

75 ~ 105 kPa

(0.75 ~ 1.05 kg/cm², 10 ~ 14 psi)

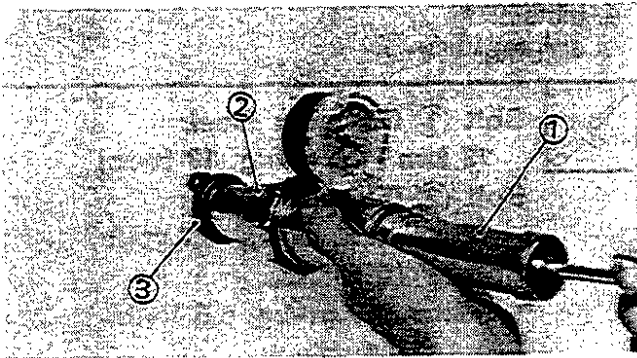

Measurement steps:

- Attach the Cooling System Tester ① and Adapter ② to the radiator cap ③.



Cooling System Tester:

90890-01325

Adapter:

90890-01352

- Apply the specified pressure for 10 seconds, and make sure there is no pressure drop.

INSTALLATION

Reverse the "REMOVAL" procedure. Note the following points.

1. Tighten:
 - Bolts (Radiator)



Bolts (Radiator):

6 Nm (0.6 m•kg, 4.3 ft•lb)

2. Fill:
 - Coolant
 - Refer to the "COOLANT REPLACEMENT" section in the CHAPTER 3.
3. Inspect:
 - Cooling system
 - Decrease of pressure (leaks) → Repair as required.

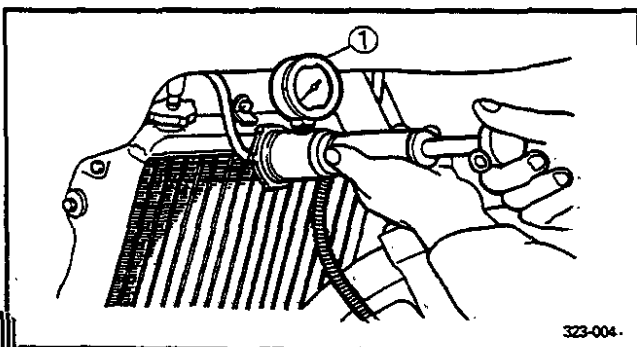

323-004.

Inspection steps:

- Attach the Cooling System Tester ① to the radiator.



Cooling System Tester:

90890-01325

- Apply 100 kPa (1.0 kg/cm², 14 psi) pressure.
- Measure the indicated pressure with the gauge.

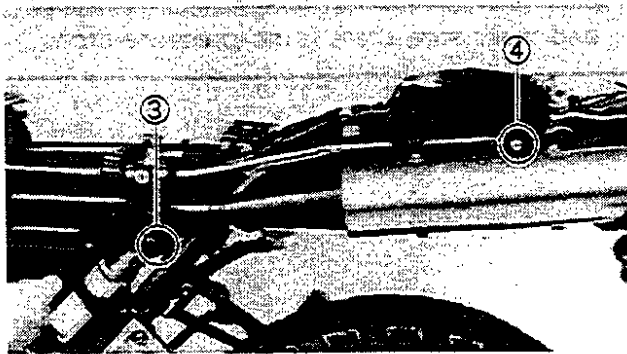
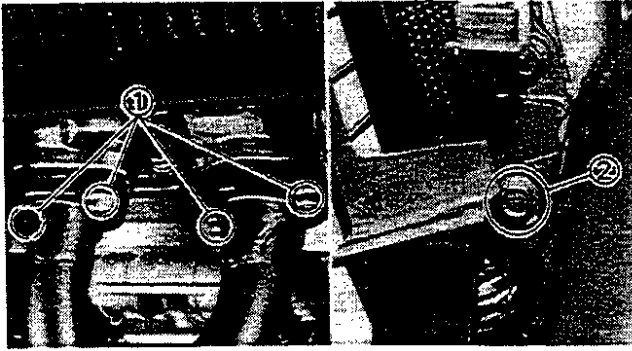

4. Install:
- Muffler



- Bolt ① (Exhaust Pipe):
18 Nm (1.8 m•kg, 13 ft•lb)
- Bolt ② (Exhaust Pipe):
12 Nm (1.2 m•kg, 8.7 ft•lb)
- Bolt ③ (Muffler):
9 Nm (0.9 m•kg, 6.5 ft•lb)
- Bolt ④ (Muffler):
38 Nm (3.8 m•kg, 27 ft•lb)

5. Install:

- Side cover
Refer to the "SIDE COVERS" section in the CHAPTER 3.
- Lower cowling
Refer to the "COWLINGS" section in the CHAPTER 3.
- Seat

THERMOSTAT

- ① Thermostat cover
- ② Thermostat

A THERMOSTAT OPENING
TEMPERATURE:
63 ~ 67°C (146 ~ 153°F)

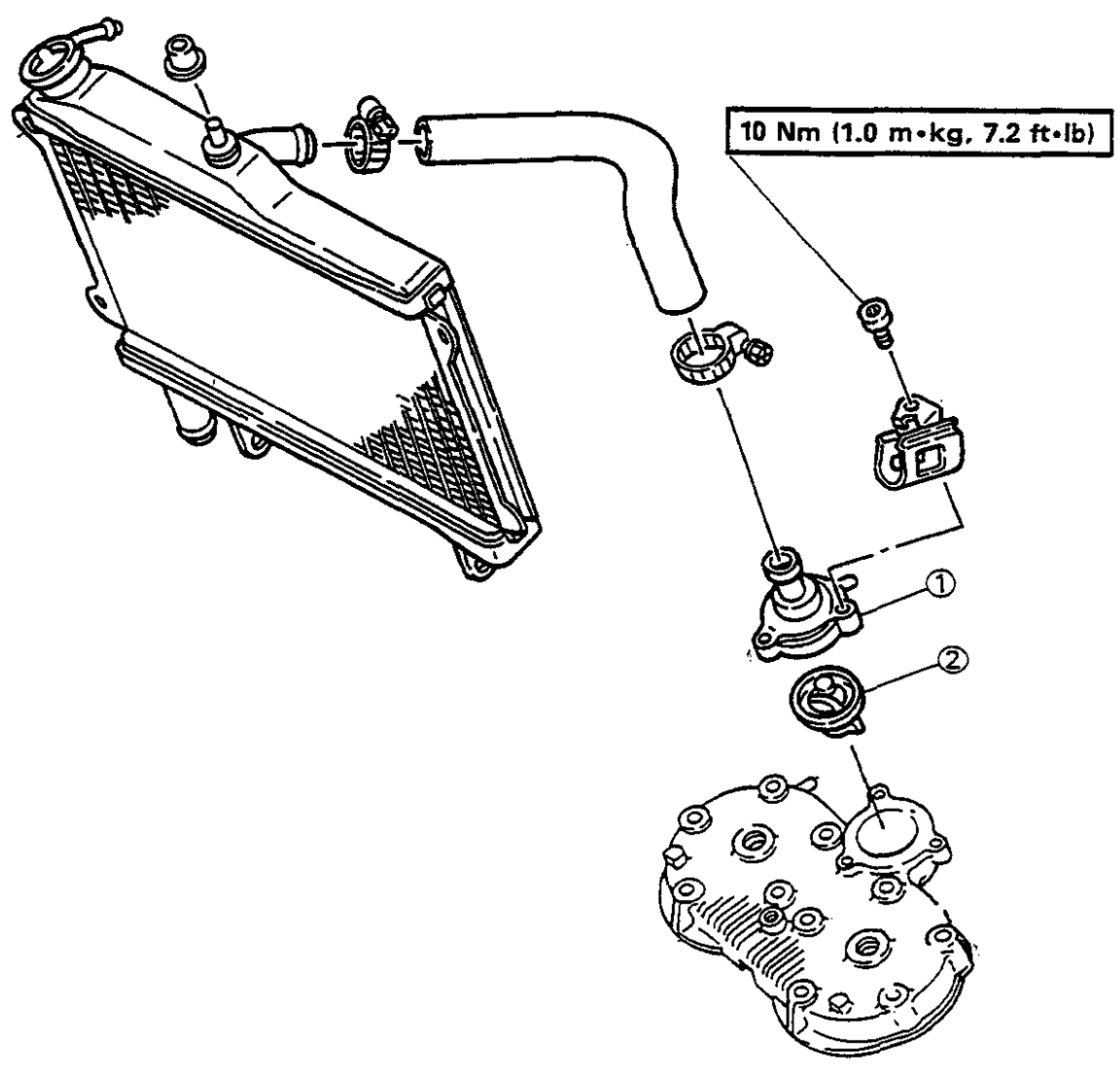

**REMOVAL**

1. Remove:

- Seat
- Lower cowling
Refer to the "COWLINGS" section in the CHAPTER 3".
- Side cover
Refer to the "SIDE COVERS" section in the CHAPTER 3".

2. Remove:

- Muffler

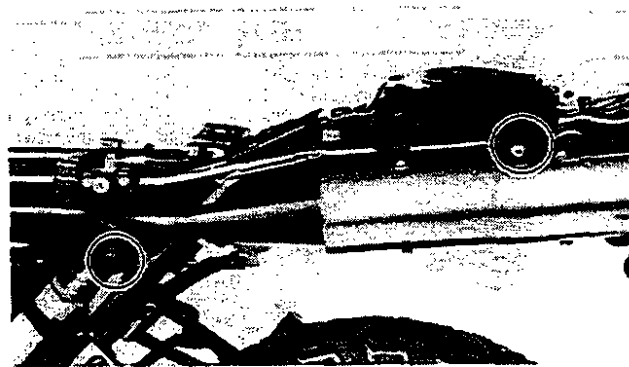
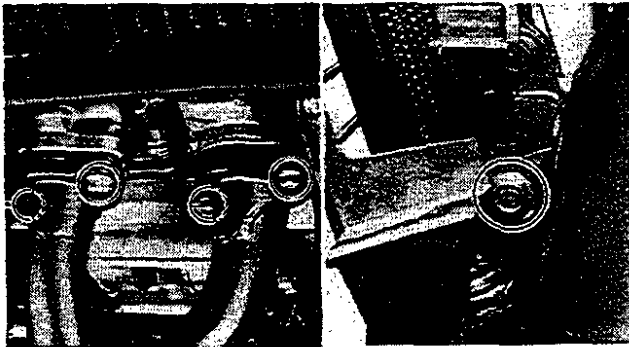

3. Drain:

- Cooling system
Refer to the "COOLANT REPLACEMENT" section in the CHAPTER 3.

NOTE: _____

Thoroughly flush the cooling system with clean tap water.

CAUTION: _____

Take care so that coolant does not splash to painted surfaces. If splashes, wash it away with water.

**WARNING:**

Do not remove the radiator cap, drain bolts and hoses especially when the engine and radiator are hot. Scalding hot fluid and steam may be blown out under pressure, which could cause serious injury. When the engine has cooled, place a thick rag like a towel over the radiator cap, slowly rotate the cap counterclockwise to the detent. This procedure allows any residual pressure to escape. When the hissing sound has stopped, press down on the cap while turning counterclockwise and remove it.

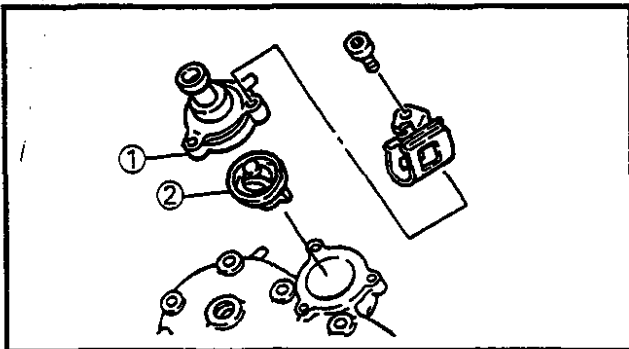

4. Remove:

- Thermostat cover ①
- Thermostat ②

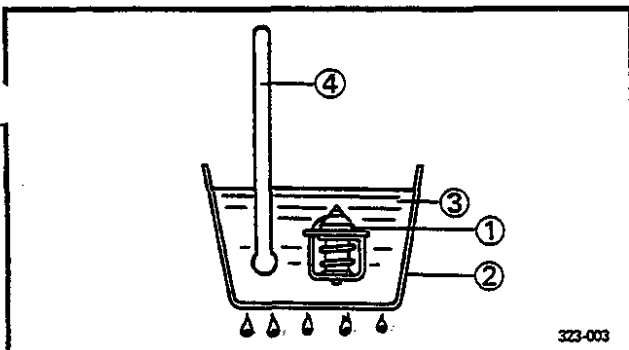
**INSPECTION**

1. Inspect

- Thermostat

Valve does not open at 63~67°C (146~153°F) → Replace.

Inspection steps:

- Suspend thermostat ① in a vessel ②.
- Place reliable thermometer in a water ③.
- Heat water slowly.
- Observe thermometer ④, while stirring water continually.

**NOTE:**

Thermostat is sealed and its setting is specialized work. If its accuracy is in doubt, always it. A faulty unit could cause serious overheating or over-cooling.

INSTALLATION

Reverse the "REMOVAL" procedure.
Note the following points.

1. Tighten:
 - Bolts (Thermostat)



Bolts (Thermostat):
10 Nm (1.0 m•kg, 7.2 ft•lb)

2. Fill:

- Coolant
Refer to the "COOLANT REPLACEMENT" section in the CHAPTER 3.

3. Install:

- Muffler



Bolt ① (Exhaust Pipe):
18 Nm (1.8 m•kg, 13 ft•lb)
Bolt ② (Exhaust Pipe):
12 Nm (1.2 m•kg, 8.7 ft•lb)
Bolt ③ (Muffler):
9 Nm (0.9 m•kg, 6.5 ft•lb)
Bolt ④ (Muffler):
38 Nm (3.8 m•kg, 27 ft•lb)

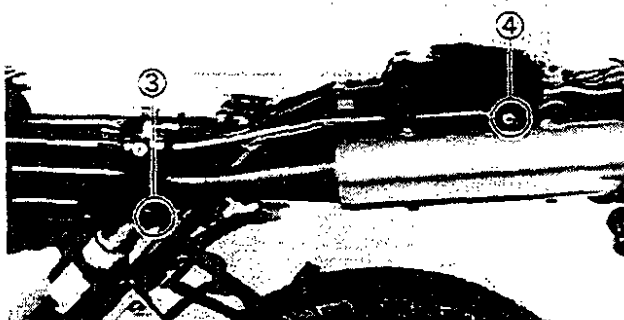
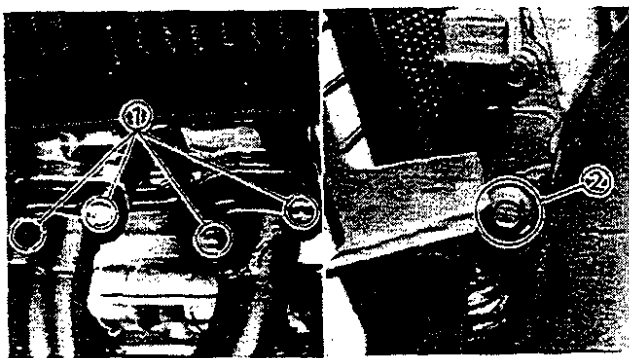

4. Install:

- Side cover
Refer to the "SIDE COVERS" section in the CHAPTER 3.
- Lower cowling
Refer to the "COWLINGS" section in the CHAPTER 3.
- Seat



CARBURETION

CARBURETOR

- ① Jet needle assembly
- ② Throttle valve
- ③ Starter plunger assembly
- ④ Needle jet
- ⑤ Throttle stop screw assembly
- ⑥ Pilot air jet
- ⑦ Needle valve assembly
- ⑧ Main jet
- ⑨ Pilot jet
- ⑩ Drain screw
- ⑪ Float
- ⑫ Float chamber
- ⑬ Carburetor body

SPECIFICATIONS	
MAIN JET (M.J.)	#210 (TDR250) #200 (TDR240)
PILOT JET (P.J.)	#20
AIR JET (A.J.)	φ1.2
PILOT AIR JET (P.A.J.)	φ1.2
JET NEEDLE (J.N.)	5L19-2/5 (TDR250) 5L19-3/5 (TDR240)
CUTAWAY (C.A.)	2.5
STARTER JET (G.S.)	#35
NEEDLE JET (N.J.)	P-8
POWER JET (PW.J.)	#50 (TDR250) #55 (TDR240)
FUEL LEVEL (F.L.)	1.5~2.5 mm (0.06~0.10 in)
FLOAT HEIGHT (F.H.)	15~17 mm (0.59~0.67 in)

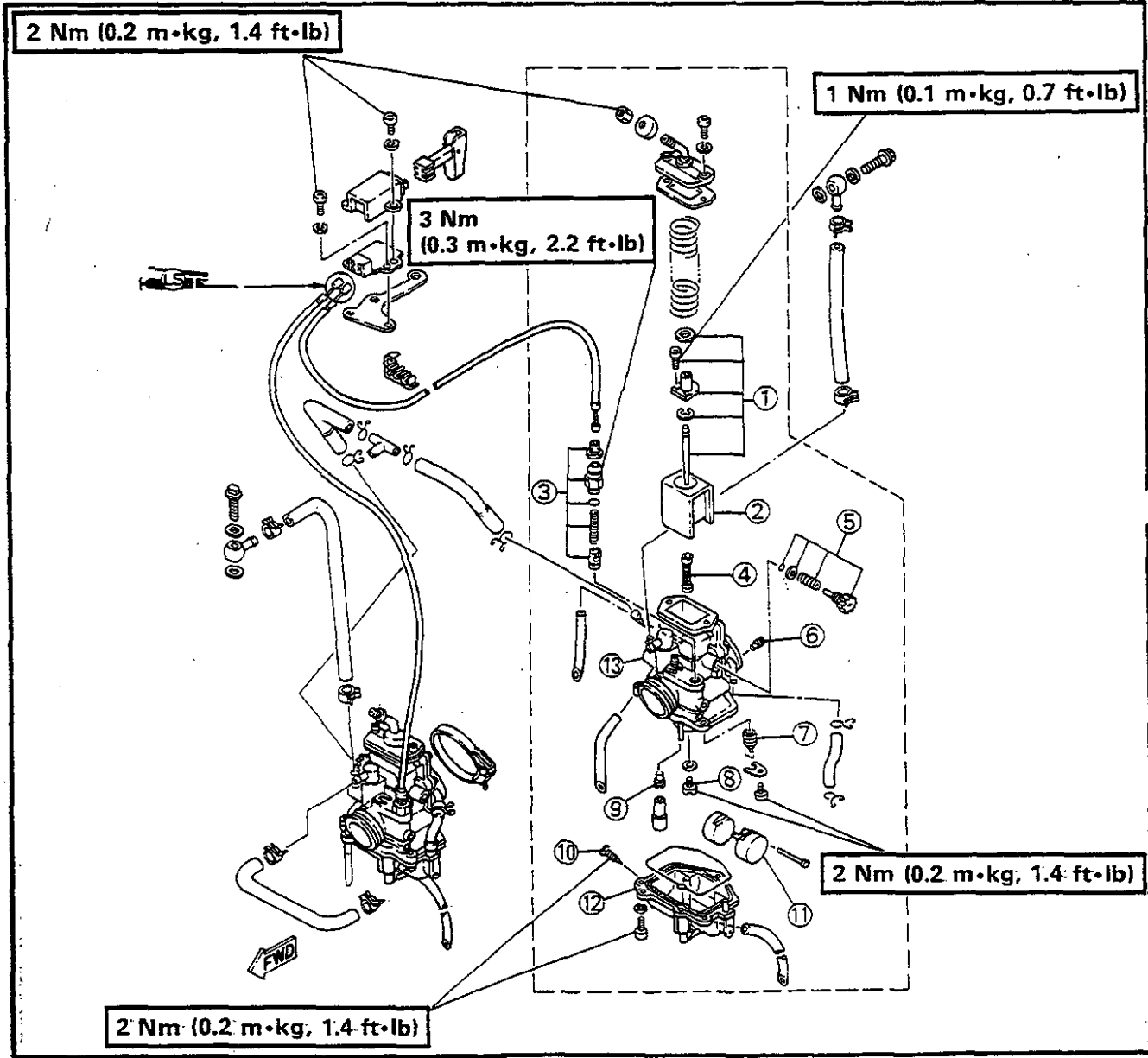



SECTION VIEW

- ① Needle jet
- ② Main jet
- ③ Pilot jet
- ④ Needle valve
- ⑤ Jet needle
- ⑥ Throttle valve

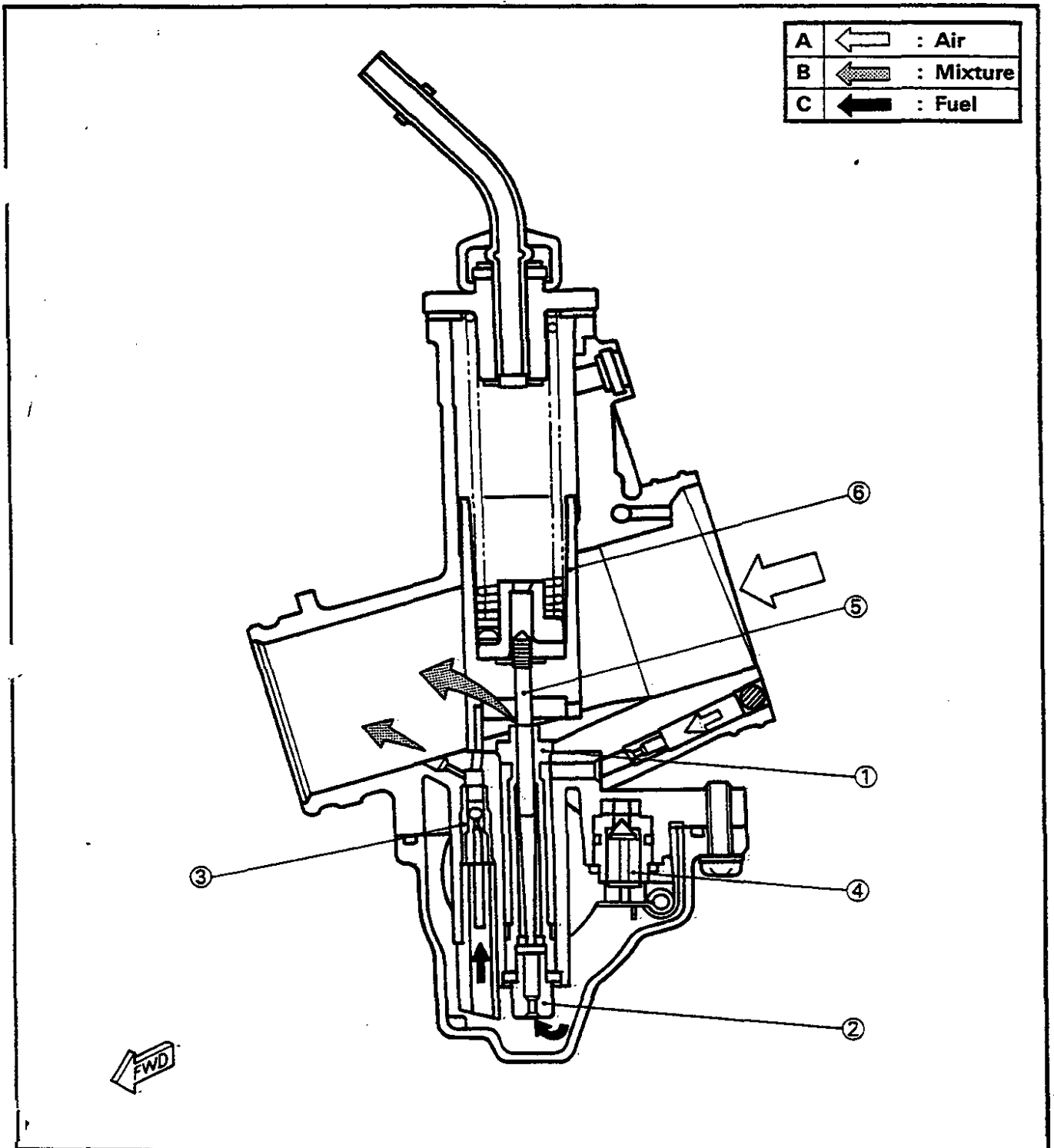



REMOVAL

NOTE:

The following parts can be cleaned and inspected without disassembly.

- Throttle valve
- Starter plunger
- Throttle stop screw

1. Remove:

- Lower cowling (Left)
- Lower cowling (Right)

Refer to "COWLINGS" section in CHAPTER 3.

2. Remove:

- Seat
- Side covers

Refer to "SIDE COVERS" section in CHAPTER 3.

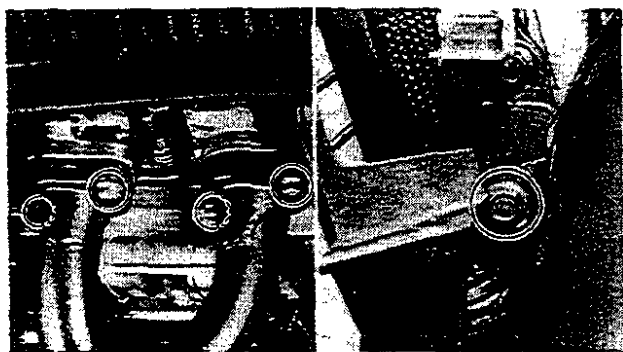

3. Drain:

- Coolant

Refer to "COOLANT REPLACEMENT" section in CHAPTER 3.

4. Remove:

- Muffler assembly

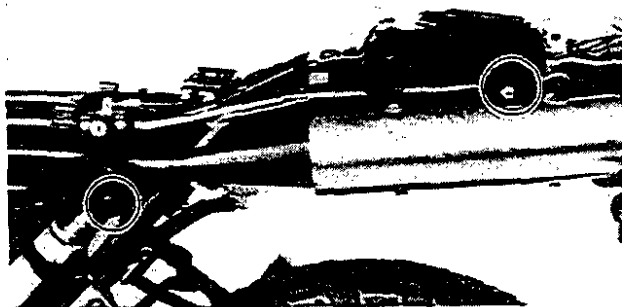

5. Turn the fuel cock to "ON" position.

6. Remove:

- Bolt ① (Fuel tank)

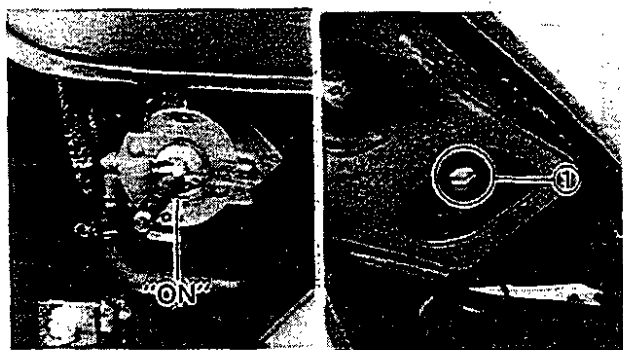

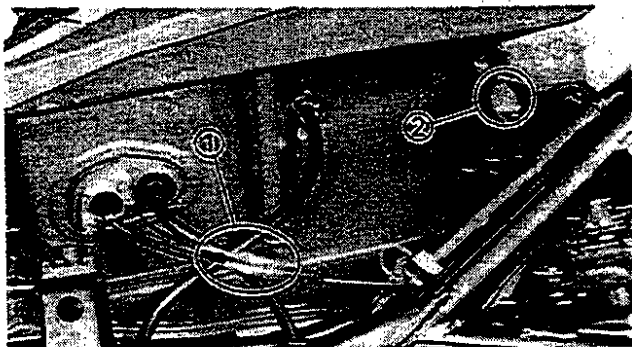

7. Disconnect:

- Oil level gauge leads ①
- Tachometer leads ②

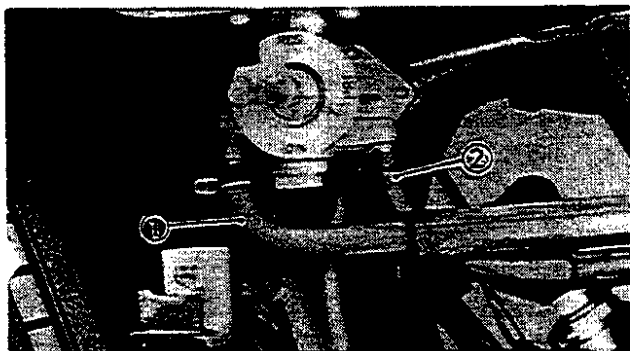

8. Disconnect:

- Fuel hose ①
- Vacuum hose ②

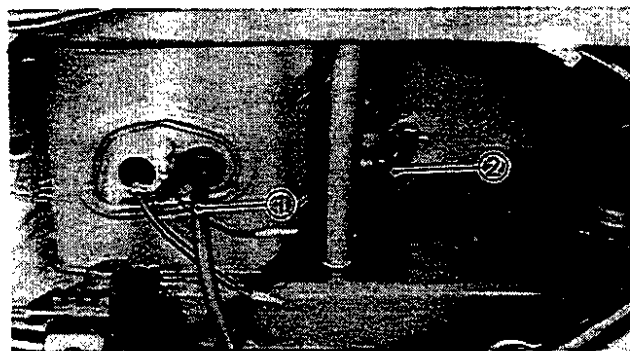

9. Disconnect:

- Oil hose ①
- Overflow hose ②

NOTE:

Plug the oil hose so that the oil will not run out of the oil tank.

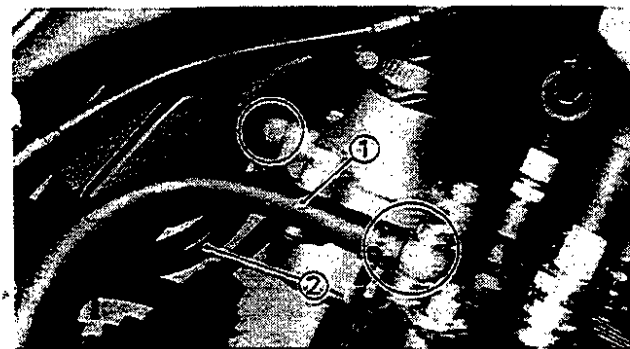

11. Disconnect

- Inlet hose ①
- Outlet hose ②

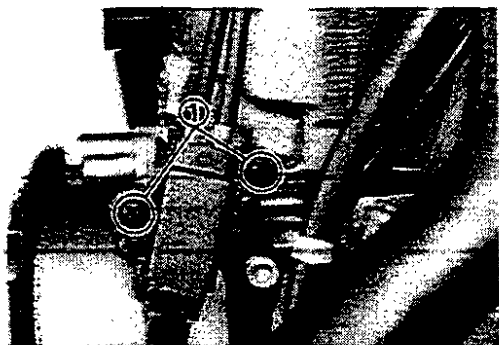

12. Remove:

- Screw ① (Starter case)

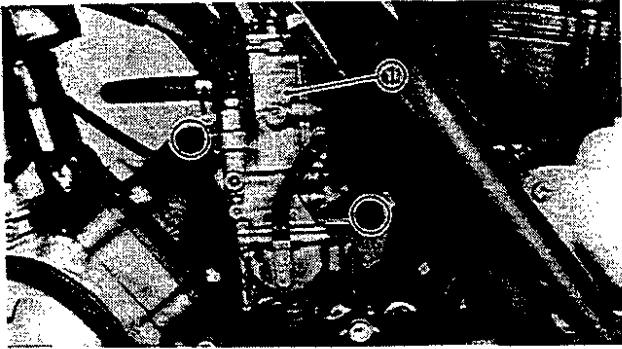

13. Remove:
 • Carburetor ①

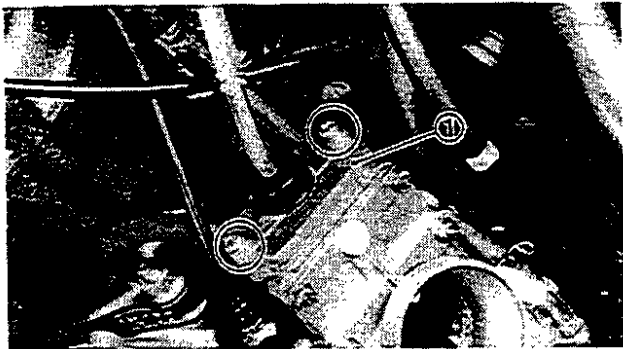

14. Remove:
 • Top cover ①

DISASSEMBLY.

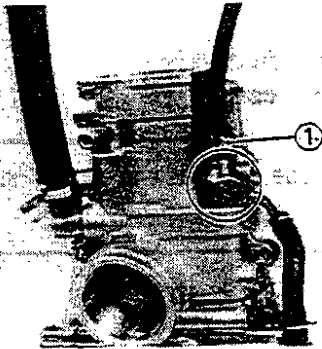

1. Remove:
 • Starter plunger assembly ①

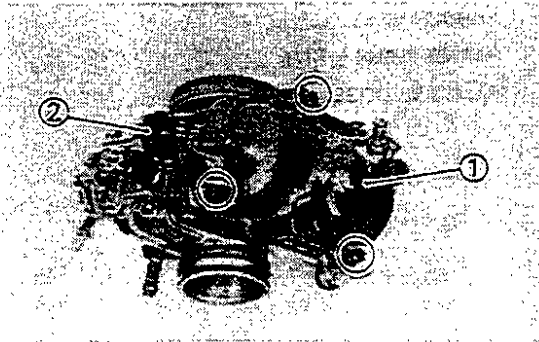

2. Remove:
 • Float chamber ①
 • Hose ②

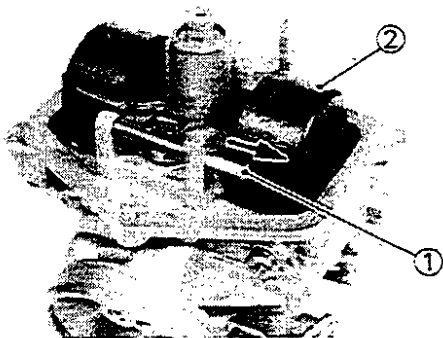

3. Remove:
 • Float pin ①
 • Float ②
 • Needle valve

NOTE: _____
 Remove the float pin in arrow direction.

CARBURETOR

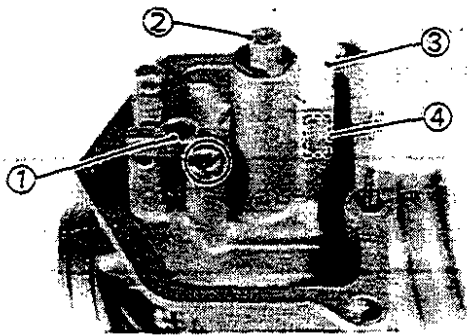

4. Remove:
- Valve seat ①
 - Main jet ②
 - Pipe ③
 - Pilot jet ④

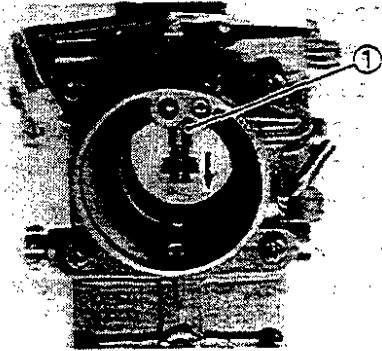

5. Remove:
- Needle jet ①

NOTE: _____
Remove the needle jet in arrow direction.

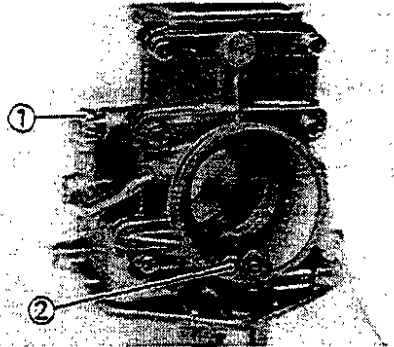

6. Remove:
- Throttle stop screw ①
 - Pilot air jet ②

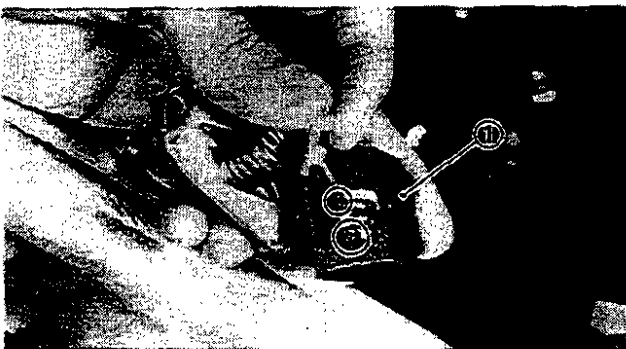

7. Remove:
- Throttle valve ①

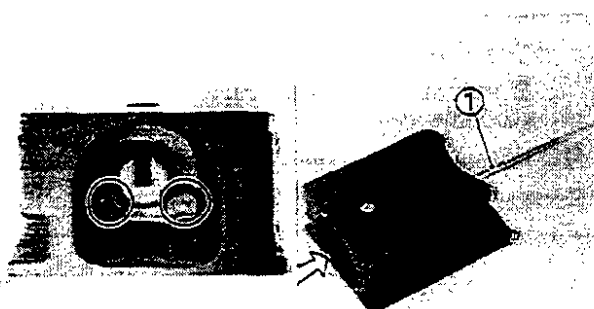

8. Remove:
- Jet needle ①

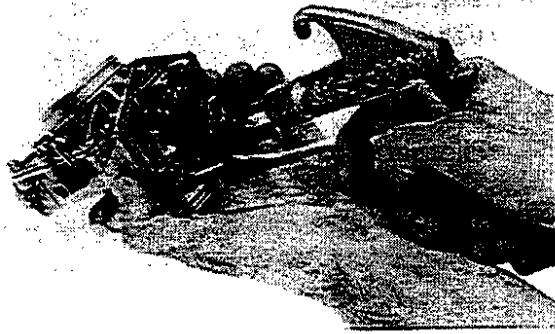

INSPECTION

1. Inspect:

- Carburetor body
Contamination → Clean.

NOTE:

Use a petroleum based solvent for cleaning. Blow out all passages and jets with compressed air.

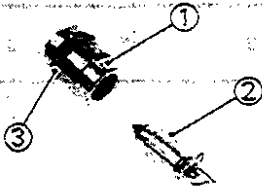

2. Inspect:

- Valve seat ①
- Needle valve ②
Wear/Contamination → Replace.
- O-ring ③
Damage → Replace.

NOTE:

Always replace the needle valve and valve seat as a set.

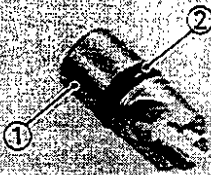

3. Inspect:

- Starter plunger ①
Wear/Contamination → Replace.
- O-ring ②
Damage → Replace.



4. Inspect:

- Throttle stop screw ①
Wear/Contamination → Replace.
- O-ring ②
Damage → Replace.

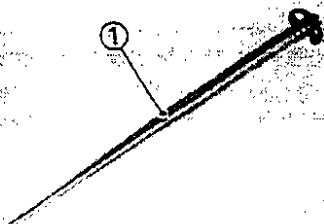

5. Inspect:

- Jet needle ①
Bends/Wear → Replace.

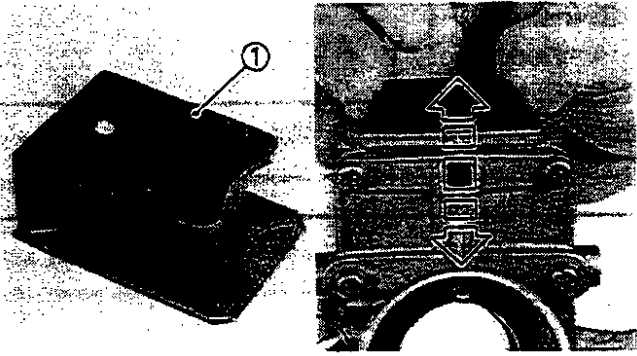

6. Inspect:

- Throttle valve ①
Wear/Damage → Replace.

7. Check:

- Free movement
Stick → Replace.
Insert the throttle valve into the carburetor body, and check for free movement.

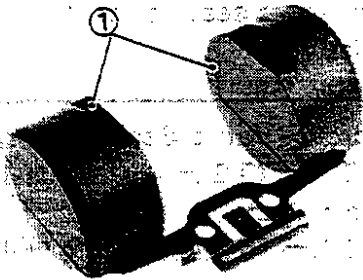

8. Inspect:

- Float ①
Damage → Replace.

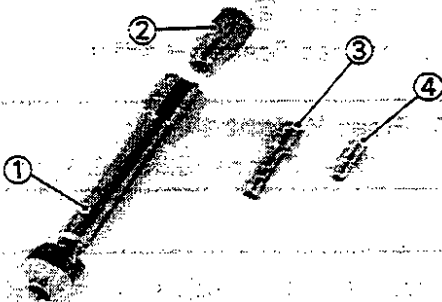

9. Inspect:

- Needle jet ①
- Main jet ②
- Pilot jet ③
- Pilot air jet ④
Contamination → Clean.

NOTE:

Blow out the jets with compressed air.

ASSEMBLY

Reverse the "DISASSEMBLY" procedures. Note the following points.

CAUTION:

Before reassembling, wash the all parts with a clean gasoline.



1. Tighten:

- Screws (Throttle valve ①)



Screws (Throttle Valve):
1 Nm (0.1 m•kg, 0.7 ft•lb)

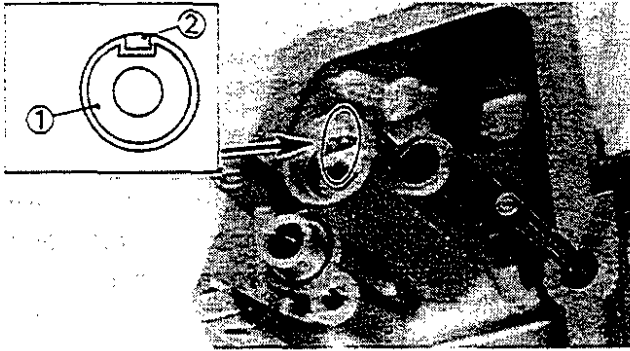

2. Install:
- Needle jet ①

NOTE: _____
Align the knock pin ② with the pin slot in the needle jet.

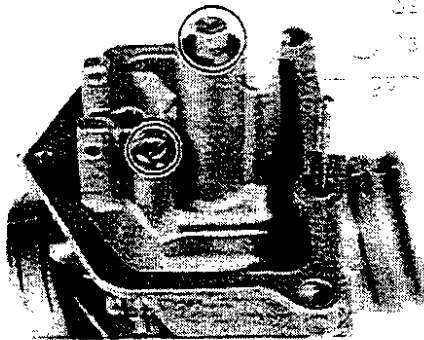

3. Tighten:
- Screw (Valve seat holder)
 - Main jet

	Screw (Valve Seat Holder):
	2 Nm (0.2 m•kg, 1.4 ft•lb)
	Main Jet:
	2 Nm (0.2 m•kg, 1.4 ft•lb)

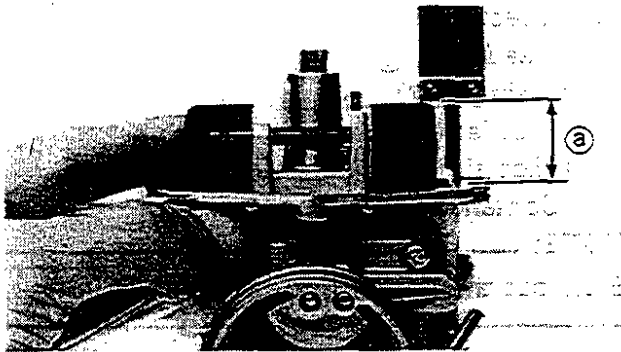

4. Measure:
- Float height ③
- Out of specification → Adjust.

	Float Height (F.H.):
	15 ~ 17 mm (0.59 ~ 0.67 in)

Measurement and adjustment steps:

- Hold the carburetor in an upside down position.
- Measure the distance from the mating surface of the float chamber (gasket removed) to the top of the float.

NOTE: _____
The float arm should be resting on the needle valve, but not compressing the needle valve.

- If the float height is not within specification, inspect the valve seat and needle valve.
- If either is worn, replace them both.
- If both are fine, adjust the float height by bending the float tang ① on the float.
- Recheck the float height.

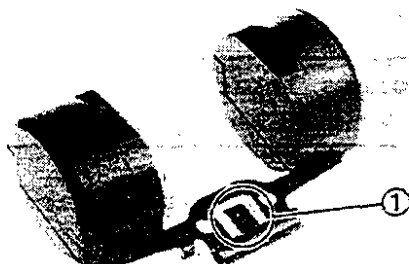

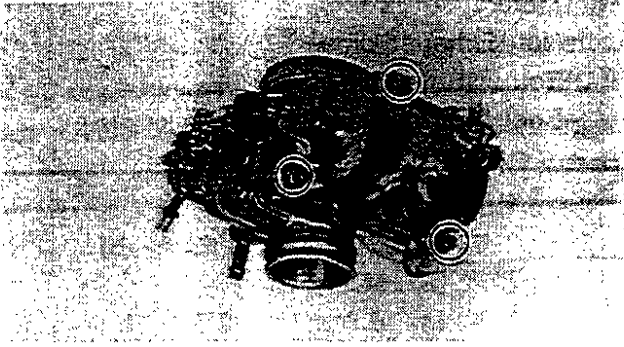

5. Tighten:
 •Screws (Float chamber)



Screws (Float Chamber):
 2 Nm (0.2 m•kg, 1.4 ft•lb)

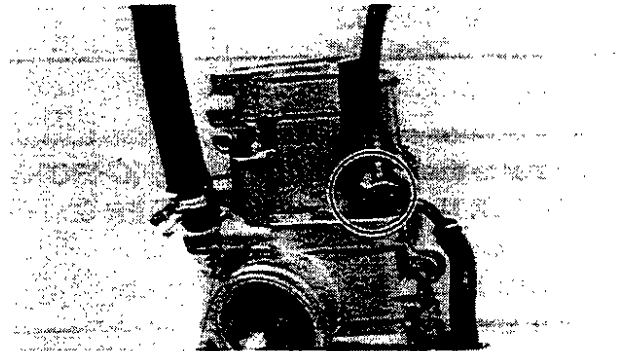

6. Tighten:
 •Nut (Starter plunger)



Nut (Starter Plunger):
 3 Nm (0.3 m•kg, 2.2 ft•lb)

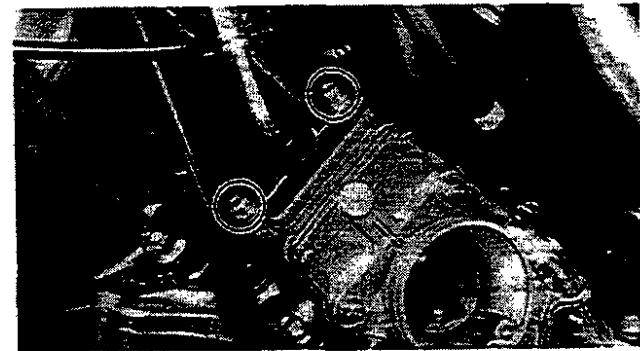

INSTALLATION

Reverse the "REMOVAL" procedures.
 Note the following points.

1. Tighten:
 •Screws (Carburetor top cover)



Screws (Carburetor Top Cover):
 2 Nm (0.2 m•kg, 1.4 ft•lb)

2. Tighten:
 •Screw (Starter lever bracket)



Screw (Starter Lever Bracket):
 2 Nm (0.2 m•kg, 1.4 ft•lb)

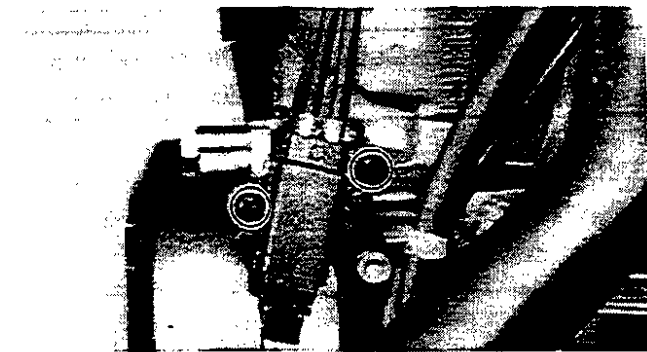

3. Fill
 •Coolant



Total Amount:
 1.45 L (1.27 Imp qt, 1.53 US qt)

Refer to "COOLANT REPLACEMENT" section in CHAPTER 3.

**4. Tighten:**

- Nut (Exhaust pipe)
- Bolt (Muffler-Front)
- Bolt (Muffler-Rear)

**Nut (Exhaust Pipe):****18 Nm (1.8 m•kg, 13 ft•lb)****Bolt (Muffler-Front):****9 Nm (0.9 m•kg, 6.5 ft•lb)****Bolt (Muffler-Rear):****38 Nm (3.8 m•kg, 27 ft•lb)****5. Adjust:**

- Carburetor synchronization

Refer to the "CARBURETOR SYNCHRONIZATION" section in the CHAPTER 3.

6. Adjust:

- Idle speed

Refer to the "IDLE SPEED ADJUSTMENT" section in the CHAPTER 3.

**Engine Idle Speed:****1,150 ~ 1,250 r/min****7. Adjust:**

- Throttle cable free play

Refer to the "THROTTLE CABLE FREE PLAY ADJUSTMENT" section in the CHAPTER 3.

**Throttle Cable Free Play:****2 ~ 5 mm (0.08 ~ 0.20 in)****FUEL LEVEL ADJUSTMENT**

1. Place the motorcycle on a level place.
2. Use a garage jack under the engine to ensure that the carburetor is positioned vertically.

CARBURETOR

CARB

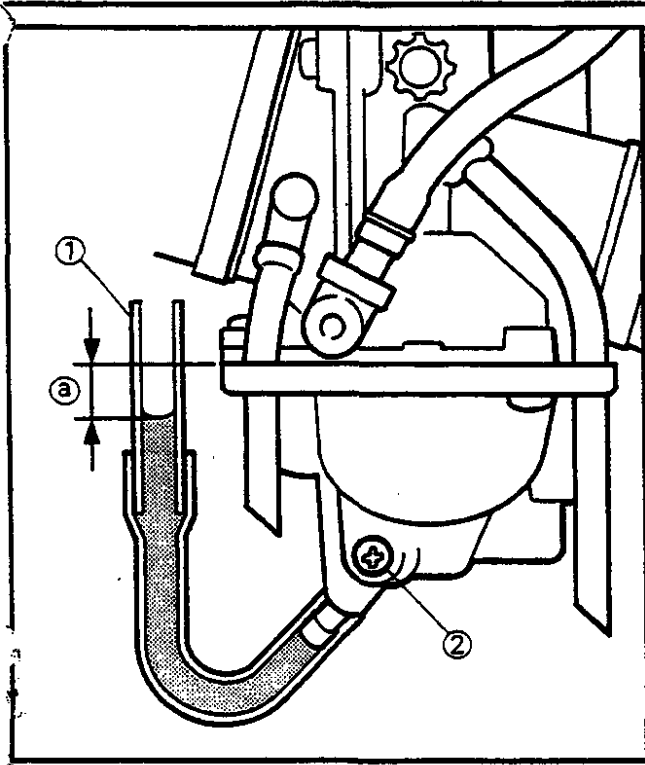

3. Attach the Fuel Level Gauge ① to the float chamber nozzle.



Fuel Level Gauge
90890-01312

4. Loosen the drain screw ②, and warm up the engine for several minutes.
5. Measure:
 - Fuel level ②Out of specification → Adjust.



Fuel Level:
1.5–2.5 mm (0.06–0.10 in)
Below the Carburetor Body Edge

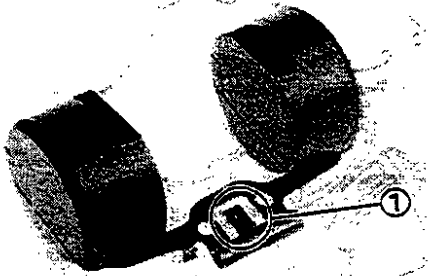

6. Adjust:
 - Fuel level

Adjustment steps:

- Remove the carburetor.
- Inspect the valve seat and needle valve.
- If either is worn, replace them both.
- If both are fine, adjust the float height by bending the float tang ① on the float.
- Recheck the fuel level.

REED VALVE

- ① Intake manifold
- ② Reed valve seat
- ③ Reed valve
- ④ Reed valve stopper
- ⑤ Gasket
- ⑥ Spacer
- ⑦ Gasket

A	REED VALVE STOPPER HEIGHT: 9.4 mm (0.37 in)
B	REED VALVE BENDING LIMIT: 1.0 mm (0.04 in)

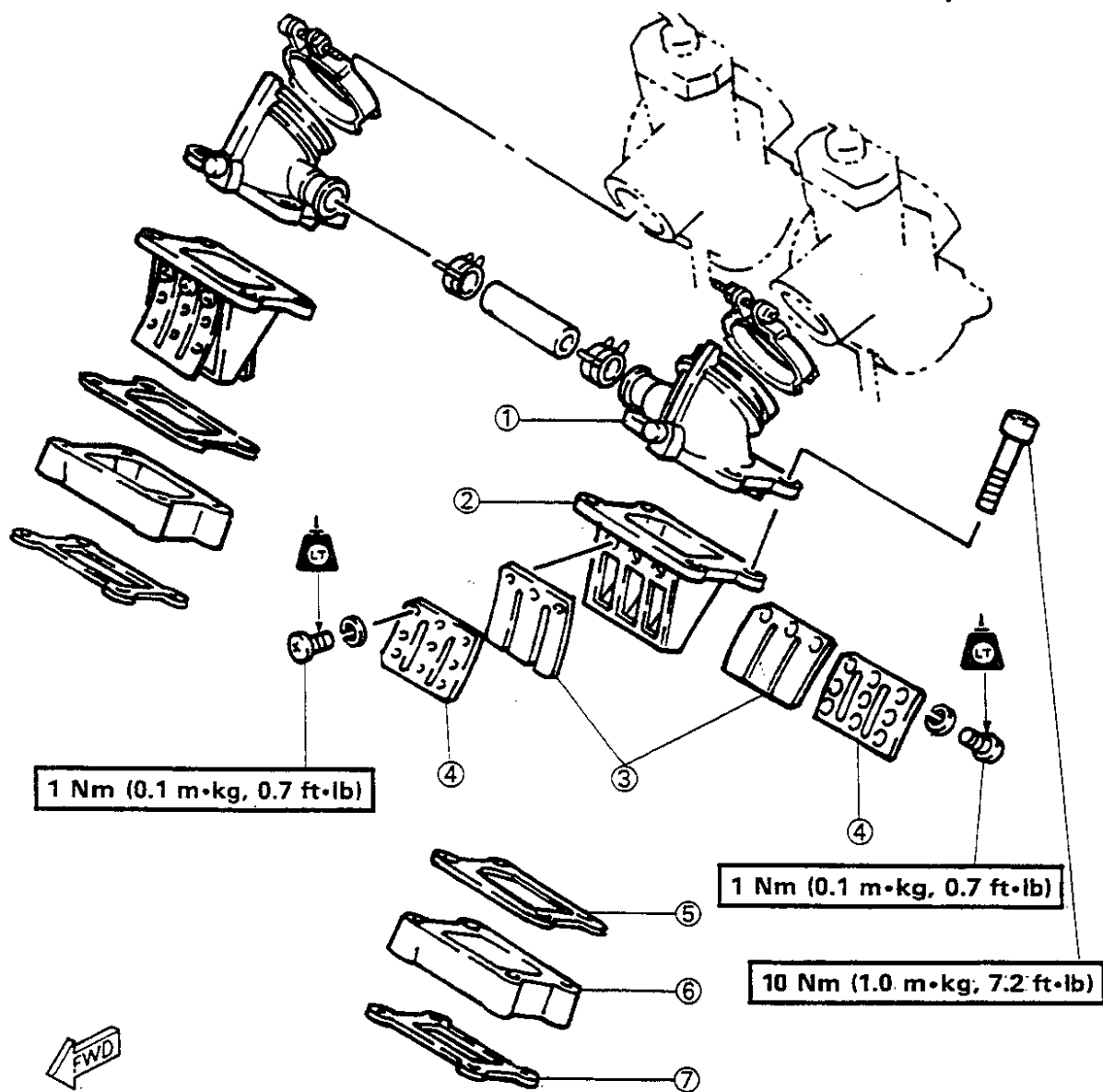



REMOVAL

1. Remove:
 - Lower cowling (Left)
 - Lower cowling (Right)
 Refer to "COWLINGS" section in CHAPTER 3.
2. Remove:
 - Seat
 - Side covers
 Refer to "SIDE COVERS" section in CHAPTER 3.
3. Remove:
 - Muffler assembly

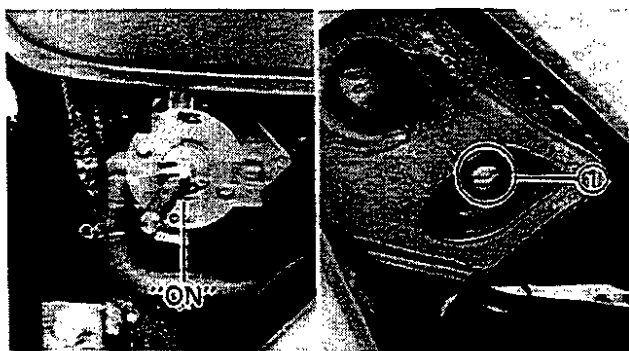
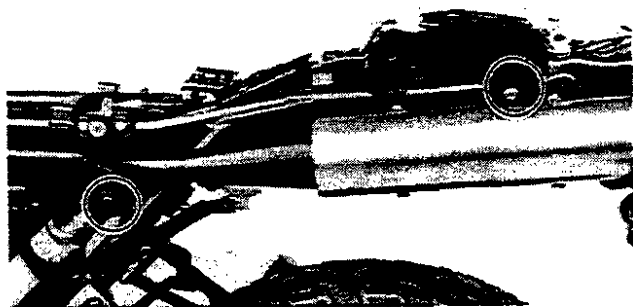
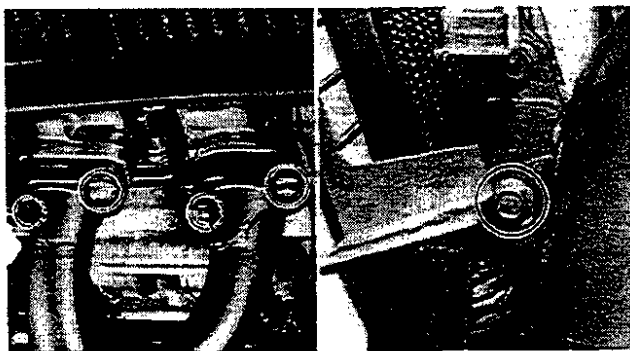

4. Turn the fuel cock to "ON" position.

5. Remove:
 - Bolt ① (Fuel tank)

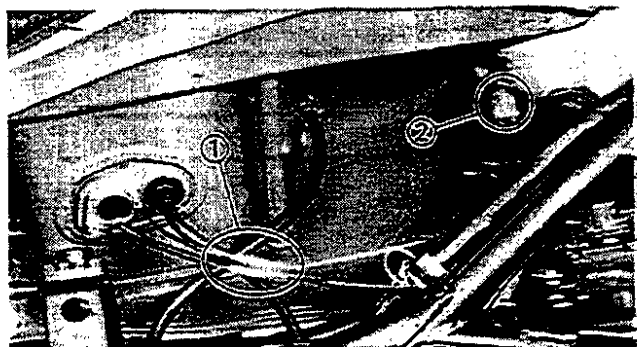

6. Disconnect:
 - Oil level gauge leads ①
 - Tachometer leads ②

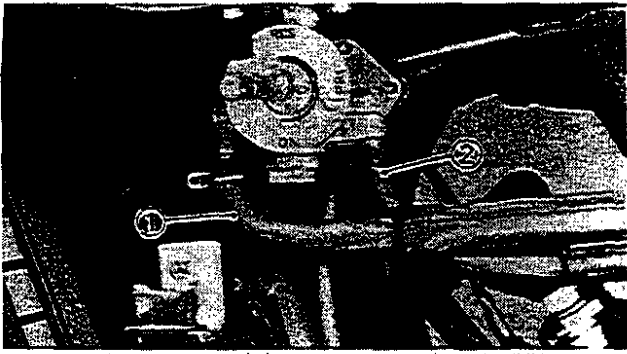

7. Disconnect:
- Fuel hose ①
 - Vacuum hose ②

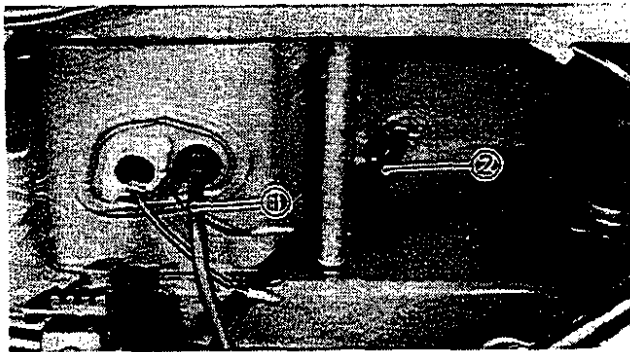

8. Disconnect:
- Oil hose ①
 - Overflow hose ②

NOTE: _____
 Plug the oil hose so that the oil will not run out of the oil tank.

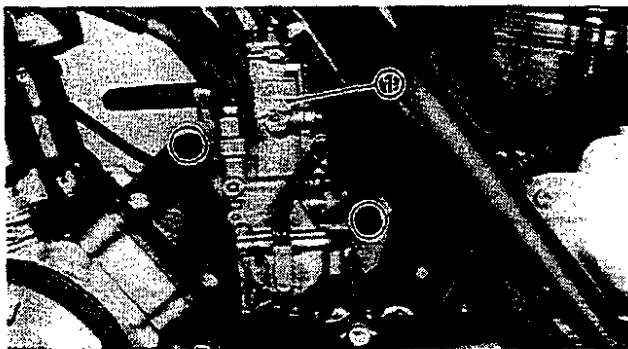

9. Remove:
- Fuel tank
10. Remove:
- Carburetors ①

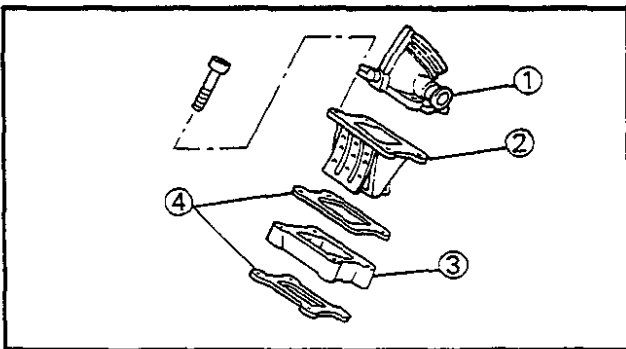

11. Remove:
- Intake manifold ①
 - Reed valve assembly ②
 - Spacer ③
 - Gasket ④

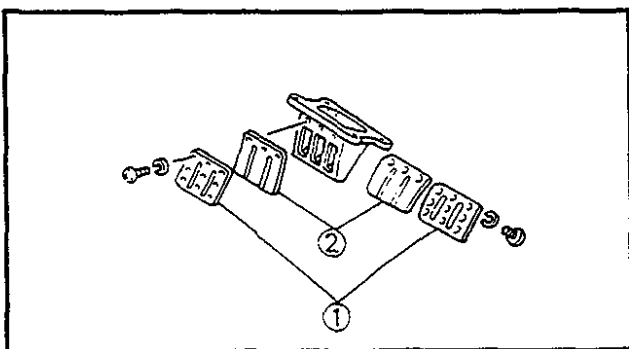

DISASSEMBLY

1. Remove:
- Reed valve stopper ①
 - Reed valve ②

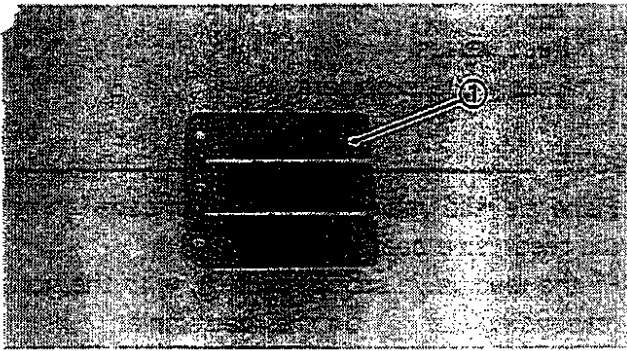

INSPECTION

1. Inspect:

- Reed valve ①
- Reed valve stopper
- Cracks/Damage → Replace.

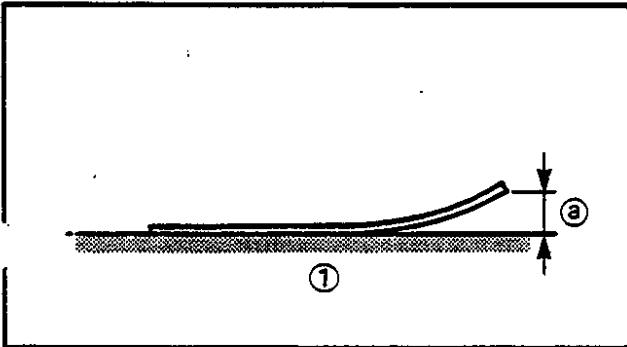

2. Measure:

- Reed valve bending limit ②
- Out of specification → Replace.

 **Reed Valve Bending Limit:**
1.0 mm (0.04 in)

① Surface plate

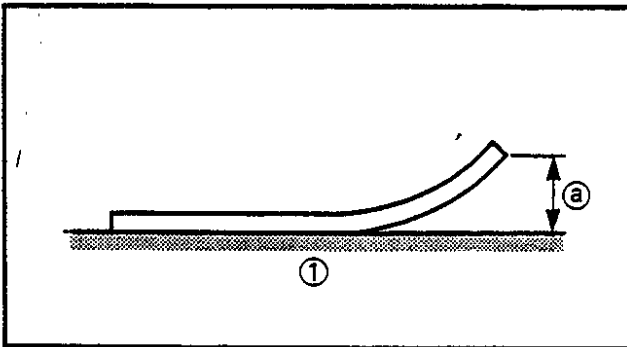

3. Measure:

- Reed valve stopper height ②
- Out of specification → Replace.

 **Reed Valve Stopper Height:**
9.4 mm (0.37 in)

① Surface plate

4. Inspect:

- Intake manifold ①
- Gaskets
- Cracks/Damage → Replace.

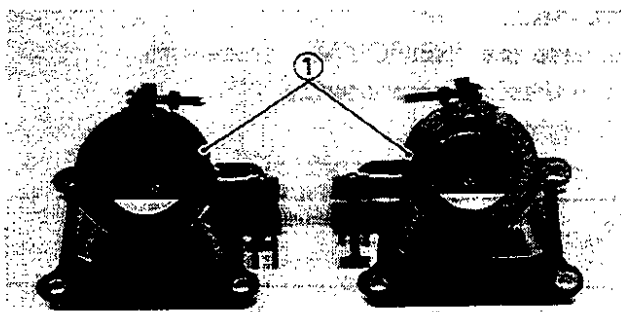

ASSEMBLY

Reverse the "DISASSEMBLY" procedure.
Note the following points.

REED VALVE

CARB

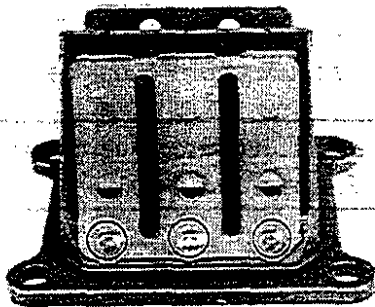
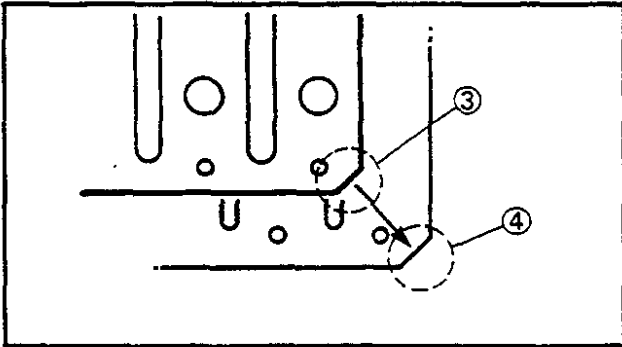
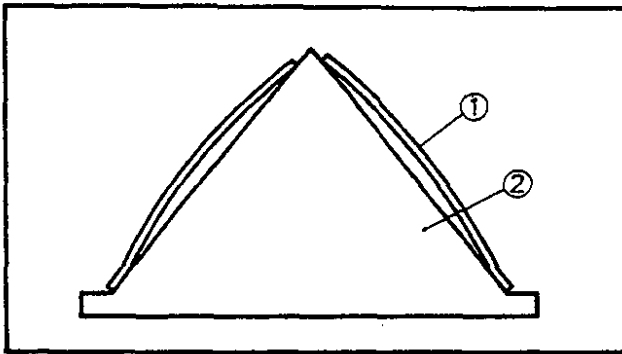

1. Install:

- Reed valves
- Reed valve stoppers

NOTE:

- Place the reed valve (1) with its concave facing the reed valve seat (2).
- Fit the reed valve stopper cut (3) with the corresponding cut (4) on the reed valve.

2. Tighten:

- Screws (Reed valve)



Screws (Reed Valve):

1 Nm (0.1 m•kg, 0.7 ft•lb)

Use LOCTITE®.

NOTE:

Tighten each screw gradually to avoid warping.

INSTALLATION

Reverse the "REMOVAL" procedure.

Note the following points.

1. Tighten:

- Bolts (Intake manifold)



Bolts (Intake Manifold):

10 Nm (1.0 m•kg, 7.2 ft•lb)

2. Tighten:

- Nut (Exhaust pipe)
- Bolt (Muffler-Front)
- Bolt (Muffler-Rear)



Nut (Exhaust Pipe):

18 Nm (1.8 m•kg, 13 ft•lb)

Bolt (Muffler-Front):

9 Nm (0.9 m•kg, 6.5 ft•lb)

Bolt (Muffler-Rear):

38 Nm (3.8 m•kg, 27 ft•lb)

CHASSIS

FRONT WHEEL

- ① Wheel axle
- ② Collar
- ③ Oil seal
- ④ Bearing
- ⑤ Balancing weight
- ⑥ Front wheel
- ⑦ Spacer
- ⑧ Bearing
- ⑨ Meter clutch
- ⑩ Clutch retainer
- ⑪ Oil seal
- ⑫ Gear unit assembly

60 Nm (6.0 m·kg, 43 ft·lb)

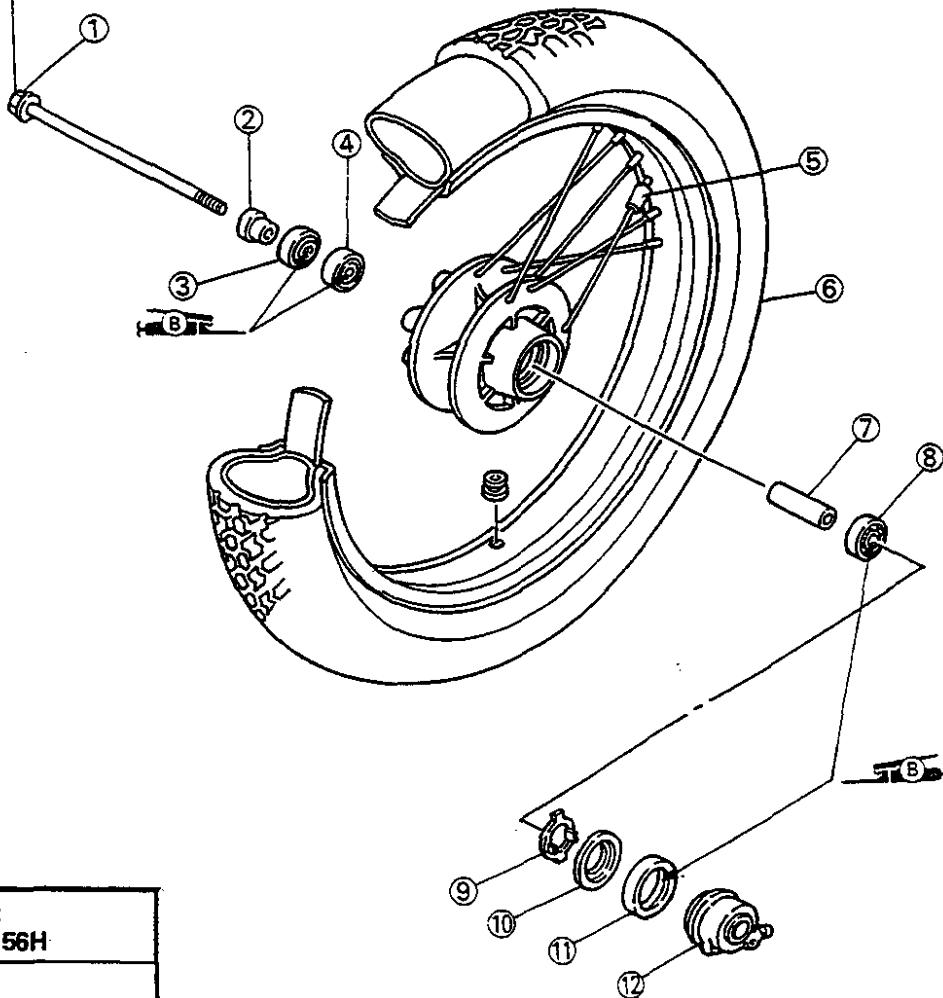

A	TIRE SIZE: 100/90-18 56H
B	RIM SIZE: 2.15×18
C	RIM RUNOUT LIMIT: VERTICAL: 2.0 mm (0.08 in) LATERAL: 2.0 mm (0.08 in)

REMOVAL

1. Elevate the front wheel by placing a suitable stand under the engine.

WARNING:

Support the motorcycle securely so there is no danger of it falling over.

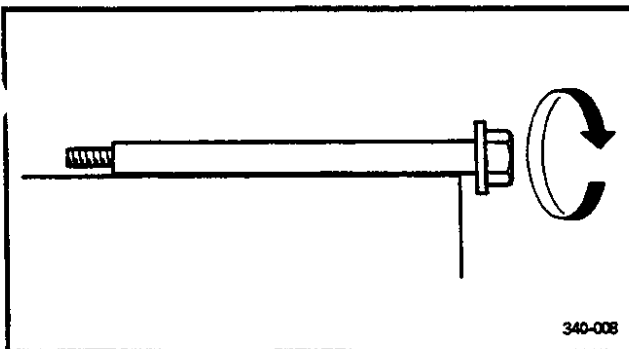
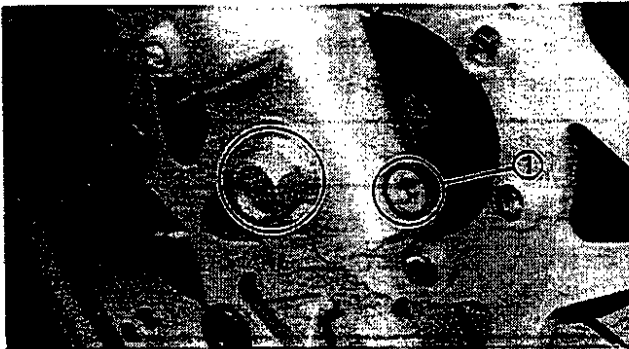
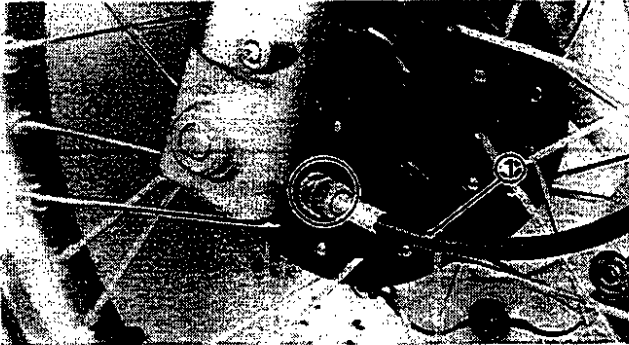

2. Disconnect:

- Speedometer cable ①

3. Loosen:

- Pinch bolt ①

4. Remove:

- Front wheel

NOTE:

Do not depress the brake lever when the wheel is off the motorcycle otherwise the brake pads will be forced shut.

INSPECTION

1. Eliminate any corrosion from parts.

2. Inspect:

- Front axle

Roll the axle on a flat surface.

Bends → Replace.

WARNING:

Do not attempt to straighten a bent axle.

3. Inspect:

- Wheel

Cracks/Bends/Warpage → Replace.

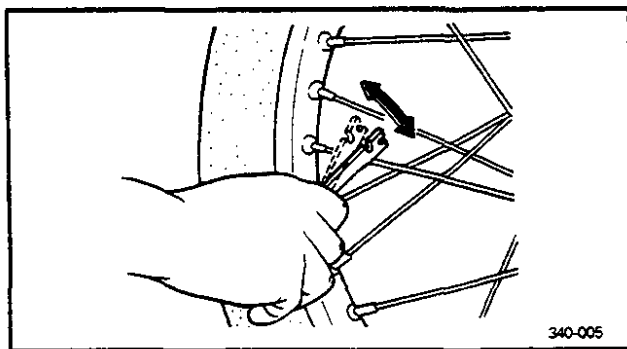
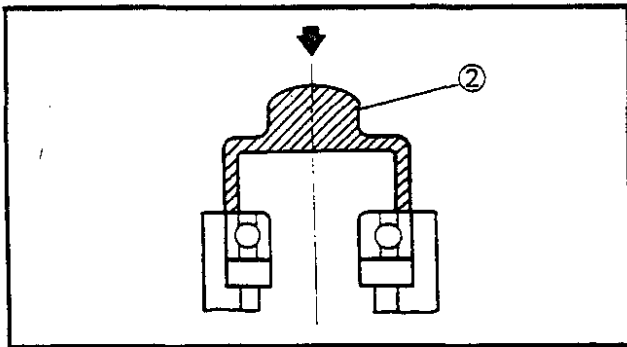
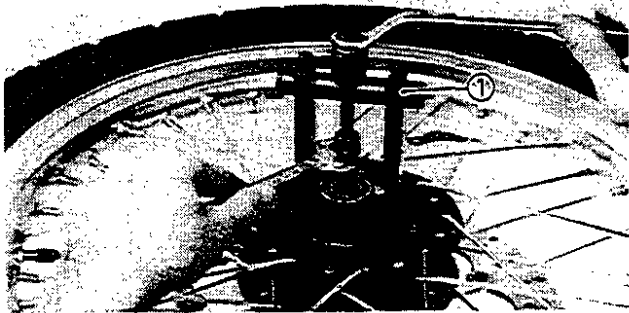
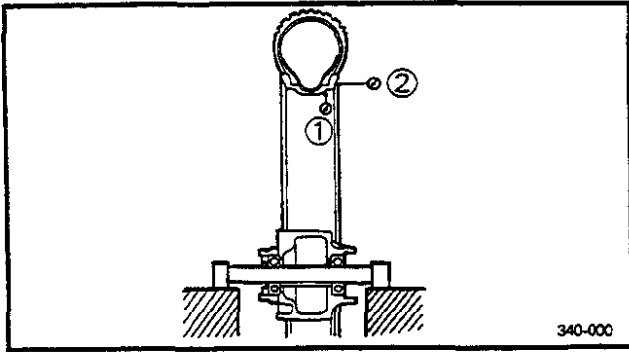

4. Measure:

- Wheel runout

Out of specification → Check the wheel and bearing play.



Rim Runout Limits:

Radial ①: 2.0 mm (0.08 in)

Lateral ②: 2.0 mm (0.08 in)

5. Check:

- Wheel bearings

Bearings allow play in the wheel hub or wheel turns roughly → Replace.

Wheel bearing replacement steps:

- Clean the outside of the wheel hub.
- Remove the bearing using a general bearing puller ①.
- Install the new bearing.

NOTE:

Use a socket ② that matches the outside diameter of the race of the bearing.

CAUTION:

Do not strike the inner race of balls of the bearing. Contact should be made only with the outer race.

6. Check:

- Spoke(s)

Bend/Damage → Replace.

Loose spoke(s) → Retighten.

Turn the wheel and tap the spokes with a screwdriver.

NOTE:

A tight spoke will emit a clear, ringing tone; a loose spoke will sound flat.

7. Tighten:

- Loose spokes



Spoke:

2 Nm (0.2 m•kg, 1.4 ft•lb)

NOTE:

Check the wheel runout after tightening spoke.

**INSTALLATION**

When installing the front wheel, reverse the "REMOVAL" procedure. Note the following points.

1. Apply:
 - Medium weight wheel bearing grease
 - Lightly grease to the oil seal and gear unit.

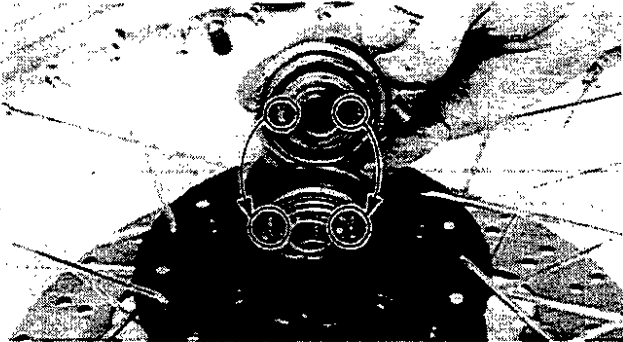

2. Install:
 - Gear unit assembly

NOTE:

Make sure the projections inside the gear unit are meshed with the flats in the wheel hub.

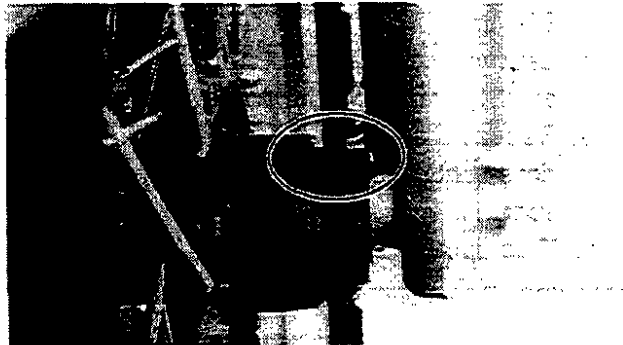

3. Install:
 - Front wheel assembly

NOTE:

Be sure the boss on the outer fork tube correctly engages with the locating slot on the gear unit assembly.

4. Tighten:
 - Wheel axle
 - Pinch bolt



Wheel Axle:
60 Nm (6.0 m•kg, 43 ft•lb)
Pinch Bolt:
20 Nm (2.0 m•kg, 14 ft•lb)

STATIC WHEEL BALANCE ADJUSTMENT**NOTE:**

- After replacing the tire and/or rim, wheel balance should be adjusted.
- Adjust the wheel balance with brake disc installed.

1. Remove:
 - Balancing weight

2. Check:
 - Spoke(s)
 - Loose spoke(s) → Retighten.

 **Spoke:**
2 Nm (0.2 m•kg, 1.4 ft•lb)

3. Set the wheel on a suitable stand.

4. Find:
 - Heavy spot

Procedure:

- a. Spin the wheel and wait for it to rest.
- b. Put an "X₁" mark on the wheel bottom spot.
- c. Turn the wheel so that the "X₁" mark is 90° up.
- d. Let the wheel fall and wait for it to rest. Put an "X₂" mark on the wheel bottom spot.
- e. Repeat the above b., c., and d. several times until these marks come to the same spot.
- f. This spot is the heavy spot "X".

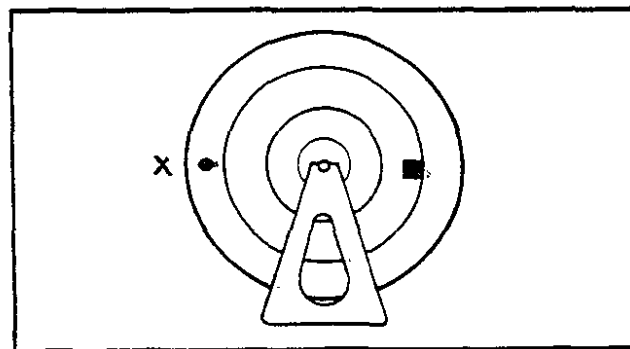
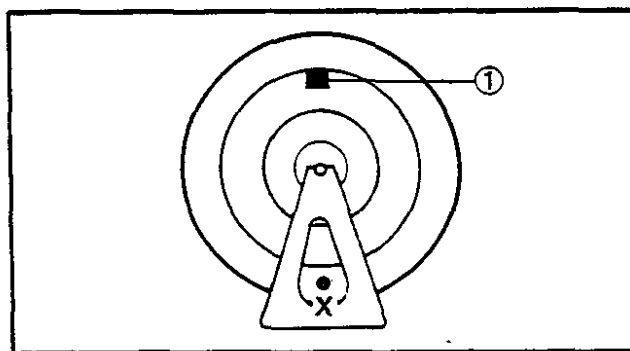
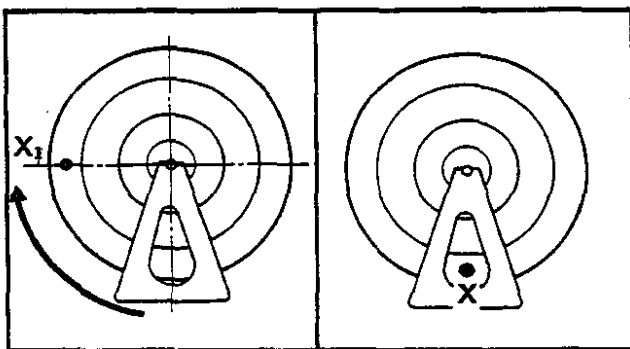
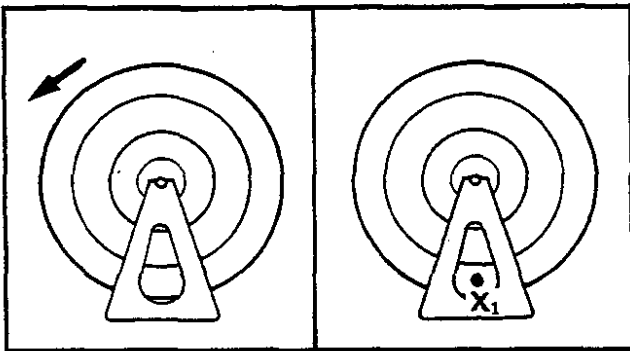

5. Adjust:
 - Wheel balance

Adjusting steps:

- Install a balancing weight ① on the spoke exactly opposite to the heavy spot "X".

NOTE: _____
Start with the smallest weight.

- Turn the wheel so that the heavy spot is 90° up.
- Check that the heavy spot is at rest there. If not, try another weight until the wheel is balanced.

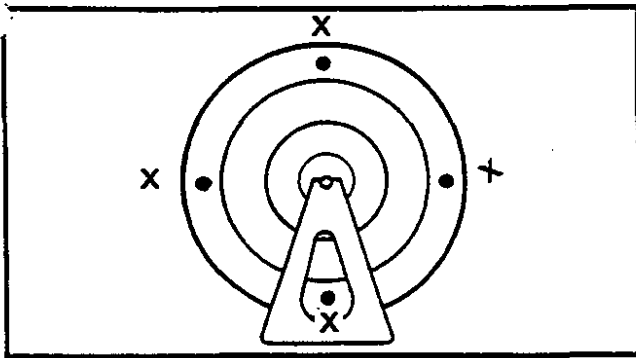

6. Check:
- Wheel balance

Checking steps:

- Turn the wheel so that it comes to each point as shown.
- Check that the wheel is at rest at each point. If not, readjust the wheel balance.



REAR WHEEL

- ① Wheel axle
- ② Flange collar
- ③ Oil seal
- ④ Bearing
- ⑤ Collar
- ⑥ Rear wheel
- ⑦ Balancing weight
- ⑧ Bearing
- ⑨ Flange collar
- ⑩ Damper
- ⑪ Hub
- ⑫ Bearing
- ⑬ Driven sprocket
- ⑭ Lock washer
- ⑮ Drive chain
- ⑯ Oil seal
- ⑰ Flange collar

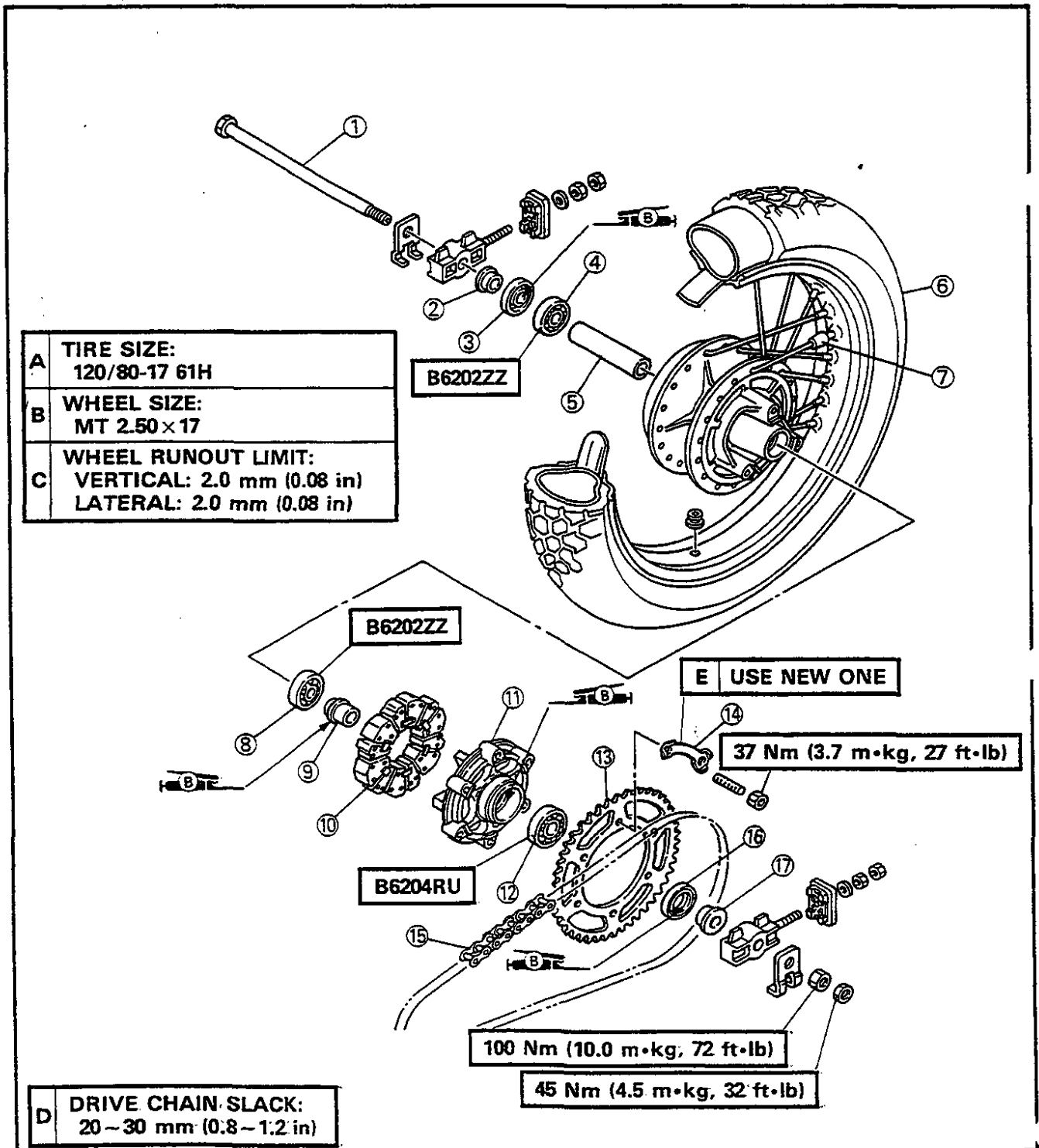

REMOVAL

1. Elevate the rear wheel by placing a suitable stand under the engine.

WARNING: _____

Support the motorcycle securely so there is no danger of it falling over.

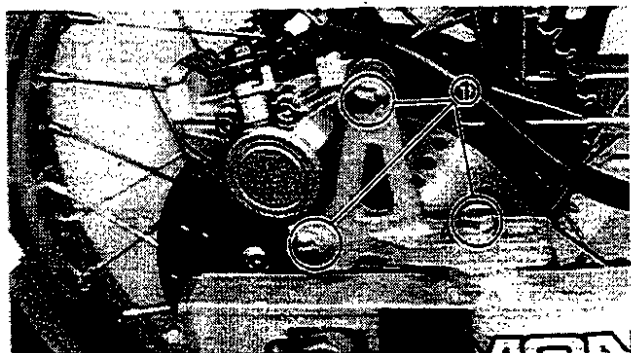

2. Remove:
 - Bolts ① (Brake caliper)

NOTE: _____

Do not depress the brake pedal when the wheel is off the motorcycle as the brake pads will be forced shut.

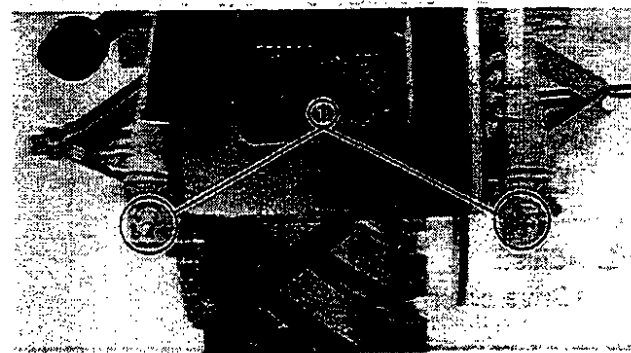

3. Loosen:
 - Nuts ① (Chain puller)

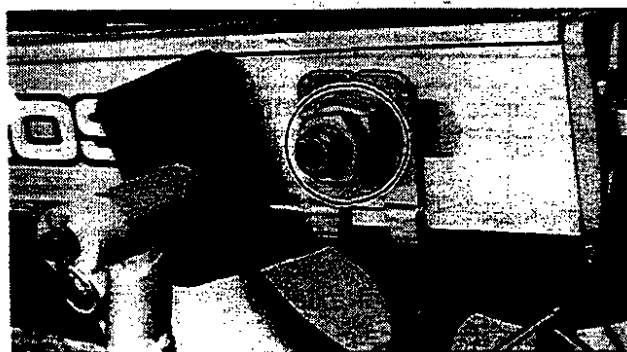

4. Remove:
 - Rear wheel

NOTE: _____

Before removing the rear wheel, push the wheel forward and remove the drive chain.

INSPECTION.

1. Inspect:
 - Rear wheel axle

Refer to "FRONT WHEEL—INSPECTION" section.

2. Inspect:
 - Wheel
Refer to "FRONT WHEEL—INSPECTION" section.
3. Measure:
 - Wheel runout
Refer to "FRONT WHEEL—INSPECTION" section.
4. Check:
 - Wheel bearings
Refer to "FRONT WHEEL—INSPECTION" section.
5. Check:
 - Spoke(s)
Refer to "FRONT WHEEL—INSPECTION" section.

INSTALLATION

When installing the rear wheel, reverse the "REMOVAL" procedure. Note the following points.

1. Apply:
 - Medium weight wheel bearing grease
Lightly grease to the oil seal lips.
2. Adjust:
 - Drive chain slack

	Drive Chain Slack: 20~30 mm (0.8~1.2 in)
---	--

Refer to "DRIVE CHAIN SLACK ADJUSTMENT" section in CHAPTER 3.

3. Tighten:
 - Axle nut
 - Locknut (Wheel axle)
 - Bolts (Brake caliper)
 - Bolt (Caliper bracket)

	Axle Nut: 100 Nm (10.0 m•kg, 72 ft•lb)
	Locknut (Wheel Axle): 45 Nm (4.5 m•kg, 32 ft•lb)
	Bolts (Brake Caliper): 35 Nm (3.5 m•kg, 25 ft•lb)
	Bolt (Caliper Bracket): 45 Nm (4.5 m•kg, 32 ft•lb)



STATIC WHEEL BALANCE ADJUSTMENT

NOTE: _____

- After replacing the tire and/or rim, wheel balance should be adjusted.
 - Adjust the wheel balance with brake disc and wheel hub installed.
-

1. Adjust:

- Wheel balance

Refer to "FRONT WHEEL—STATIC WHEEL BALANCE ADJUSTMENT" section in CHAPTER 7.

FRONT AND REAR BRAKE

- ① Master cylinder cap
- ② Rubber seal
- ③ Master cylinder kit
- ④ Master cylinder
- ⑤ Brake hose
- ⑥ Brake caliper
- ⑦ Pad spring
- ⑧ Piston
- ⑨ Piston seal
- ⑩ Brake pad
- ⑪ Brake disc

A	BRAKE FLUID TYPE: DOT #4 If DOT #4 is not available DOT #3 can be used.
B	BRAKE PAD WEAR LIMIT: 0.5 mm (0.02 in)
C	BRAKE DISC WEAR LIMIT: 4.5 mm (0.18 in)

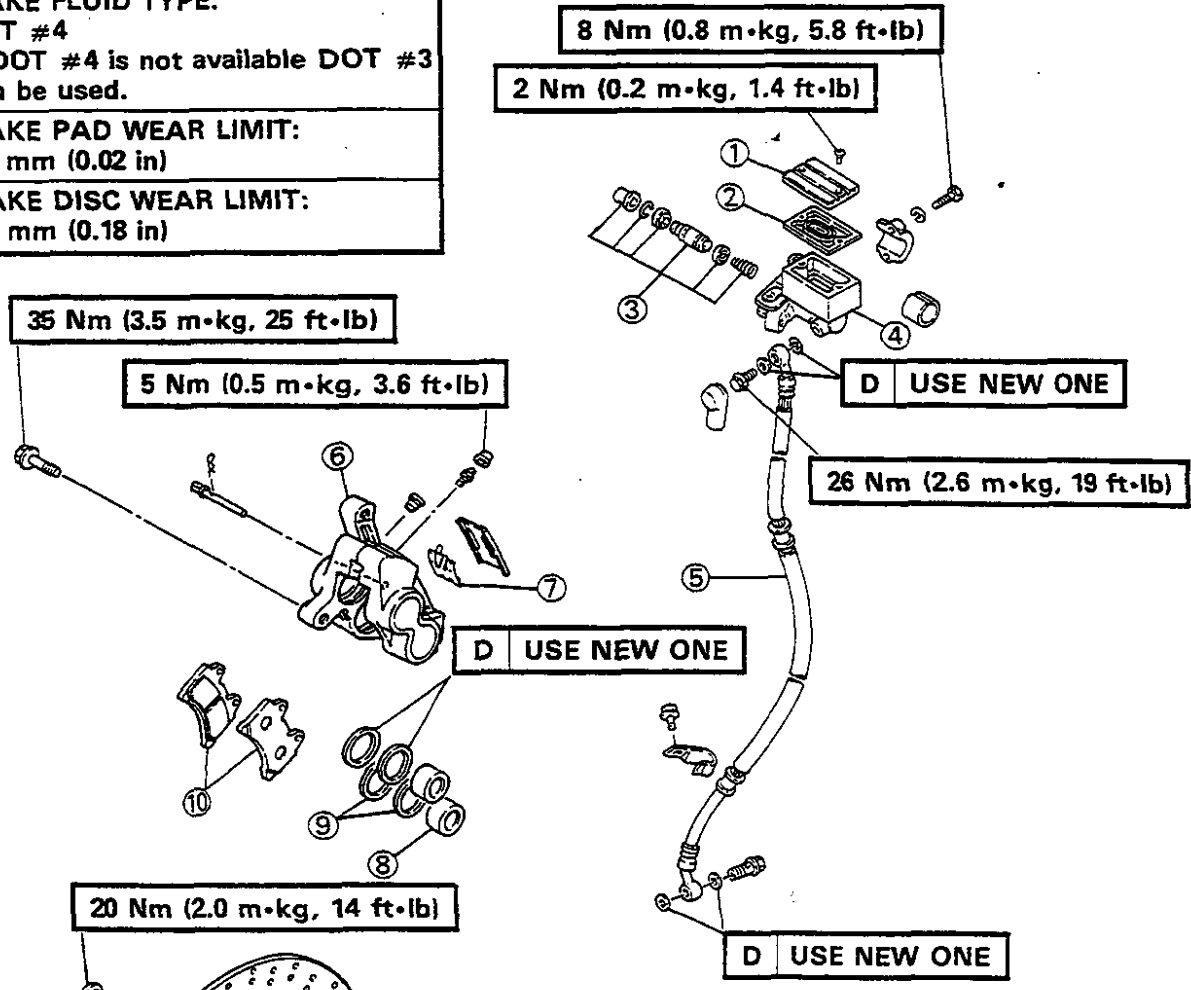

E Install the pad spring with it longer tangs facing towards the disc rotation direction.

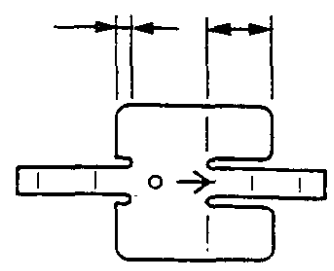

FRONT AND REAR BRAKE



- ① Reservoir tank cap
- ② Bush
- ③ Diaphragm
- ④ Reservoir tank
- ⑤ Reservoir hose
- ⑥ Master cylinder
- ⑦ Master cylinder kit
- ⑧ Brake hose
- ⑨ Brake pedal
- ⑩ Caliper bracket
- ⑪ Brake caliper
- ⑫ Piston
- ⑬ Piston seal
- ⑭ Shim
- ⑮ Brake pad
- ⑯ Pad spring
- ⑰ Brake disc

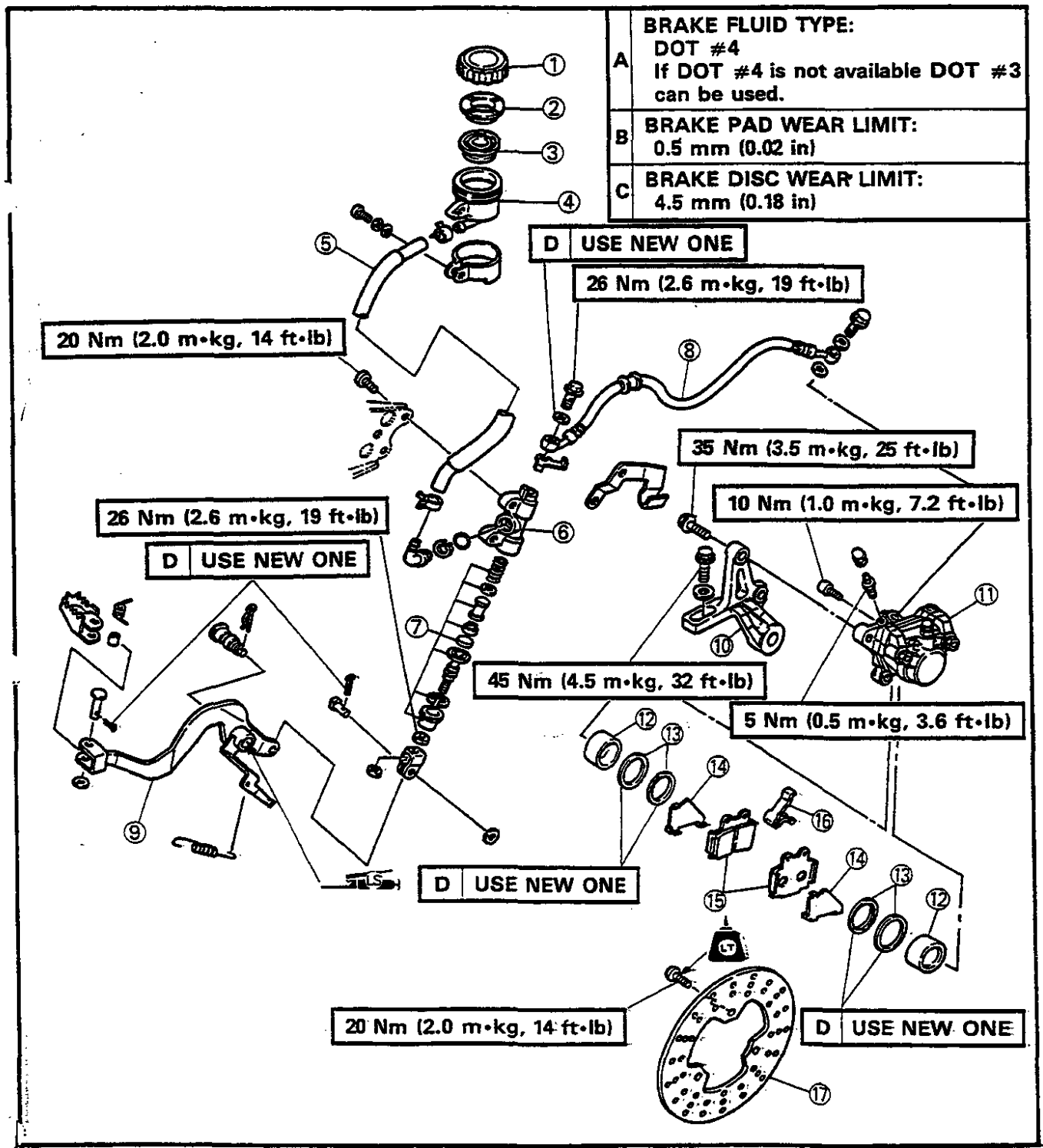

**CAUTION:**

Disc brake components rarely require disassembly. Do not disassemble components unless absolutely necessary. If any hydraulic connection in the system is opened, the entire system should be disassembled, drained, cleaned and then properly filled and bled upon reassembly. Do not use solvents on brake internal components. Solvents will cause seals to swell and distort. Use only clean brake fluid for cleaning. Use care with brake fluid. Brake fluid is injurious to eyes and will damage painted surfaces and plastic parts.

BRAKE PAD REPLACEMENT**NOTE:**

It is not necessary to disassemble the brake caliper and brake hose to replace the brake pads.

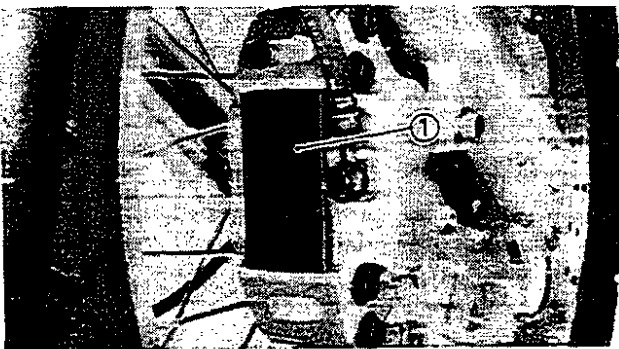
**Front Brake****1. Remove:**

- Caliper cover ①

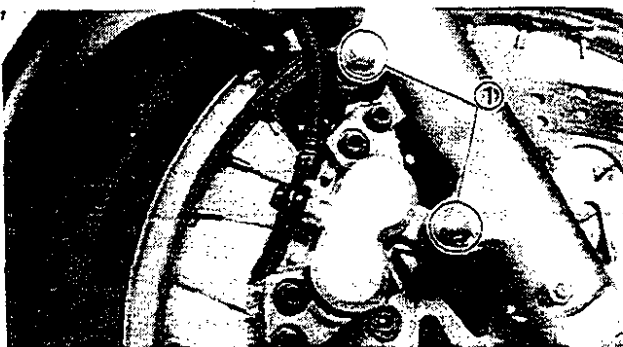
**2. Remove:**

- Bolts ① (Brake caliper)

FRONT AND REAR BRAKE

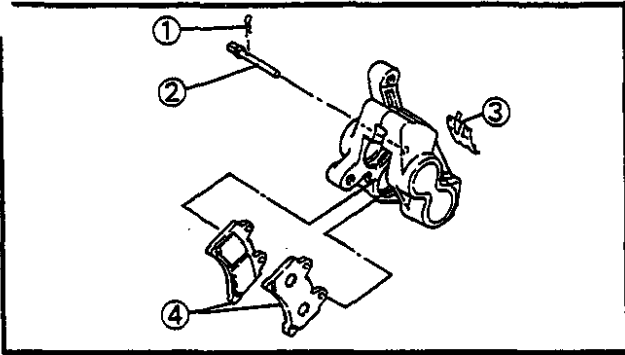

3. Remove:

- Clips ①
- Retaining pins ②
- Pad spring ③
- Brake pads ④

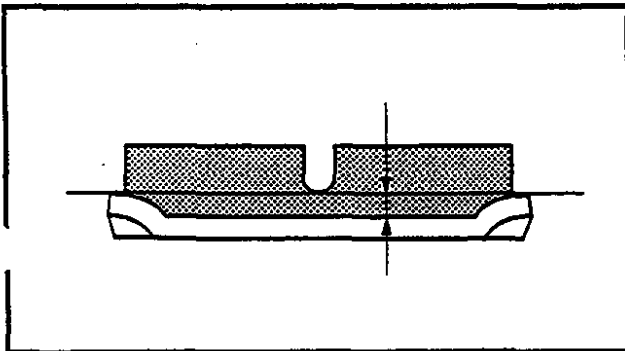

Pad Wear Limit:
0.5 mm (0.02 in)

NOTE:

Replace the pads as a set if either is found to be worn to the wear limit.

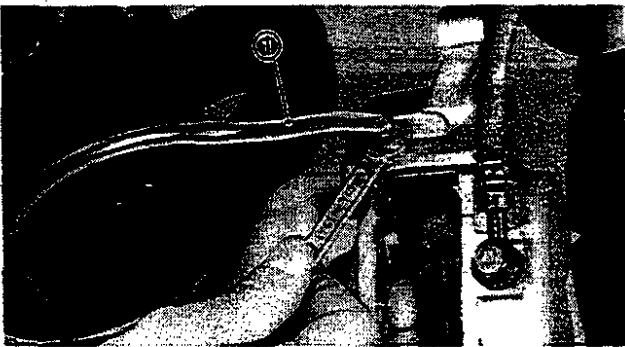

4. Connect a suitable hose ① tightly to the caliper bleed screw. Then, place other end of this hose into an open container.

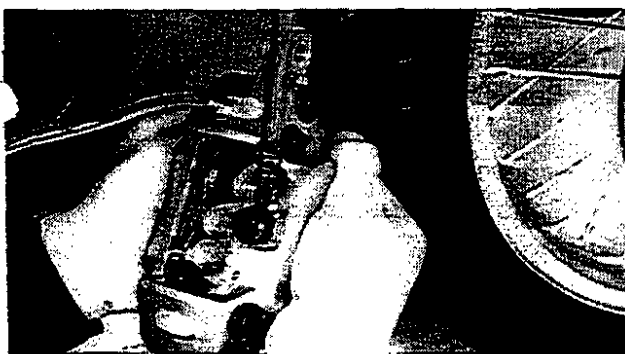

5. Loosen the caliper bleed screw and push the pistons into the caliper by your finger.

6. Tighten:

- Caliper bleed screw



Caliper Bleed Screw:
5 Nm (0.5 m•kg, 3.6 ft•lb)

7. Install:

- Brake pads (New)
- Pad spring
- Retaining pins
- Clips

NOTE:

Install the pad spring with its longer tangs facing towards the disc rotation direction.

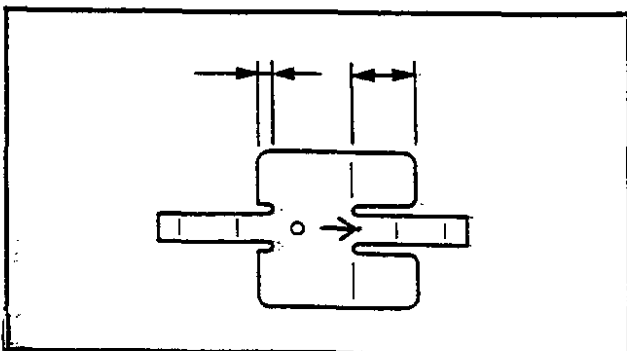

8. Install:
 - Bolts (Brake caliper)
 - Caliper cover

 **Bolts (Brake Caliper):**
35 Nm (3.5 m•kg, 25 ft•lb)

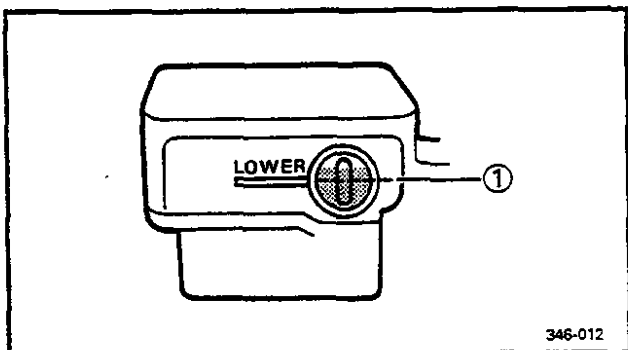

9. Inspect:
 - Brake fluid level
 Refer to "BRAKE FLUID INSPECTION" section in CHAPTER 3.

① "LOWER" level line

10. Check:
 - Brake lever operation
 A softy or spongy filling → Bleed brake system.
 Refer to "AIR BLEEDING" section in CHAPTER 3.

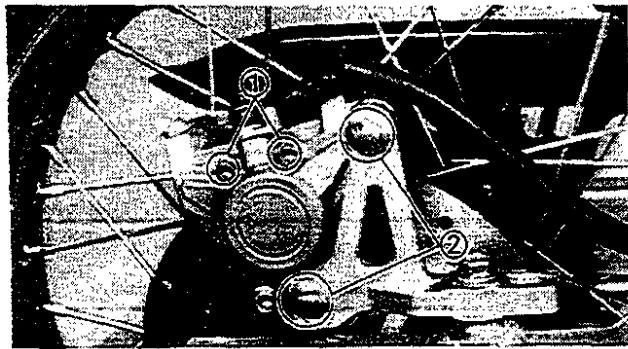

Rear Brake

1. Loosen:
 - Retaining bolts ①
2. Remove:
 - Bolts ② (Brake caliper)

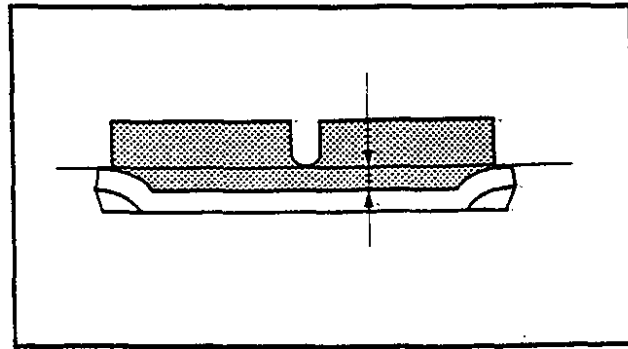

3. Remove:
 - Retaining bolts
 - Brake pads

 **Pad Wear Limit:**
0.5 mm (0.02 in)

NOTE: _____
 Replace the pads as a set if either is found to be worn to the wear limit.

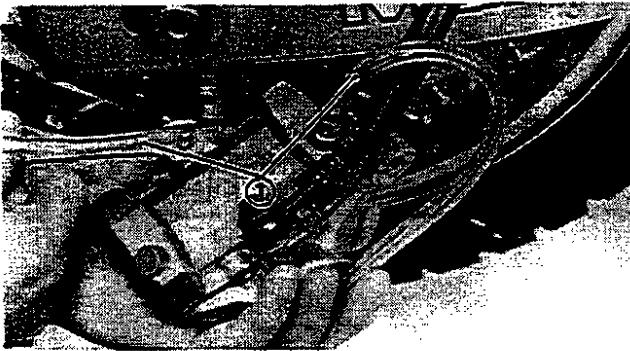

4. Connect a suitable hose ① tightly to the caliper bleed screw. Then, place other end of this hose into an open container.

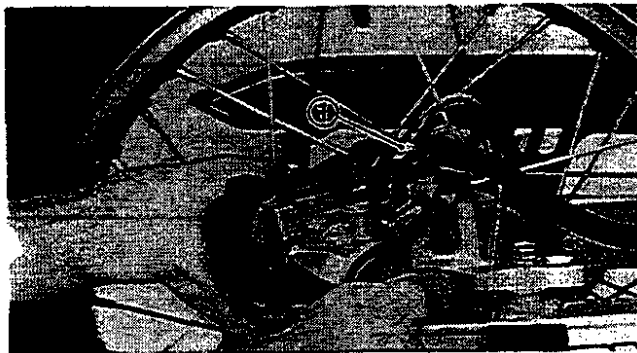

5. Loosen the caliper bleed screw ① and push the pistons into the caliper by your finger.

6. Tighten:
• Caliper bleed screw

	Caliper Bleed Screw: 5 Nm (0.5 m•kg, 3.6 ft•lb)
--	---

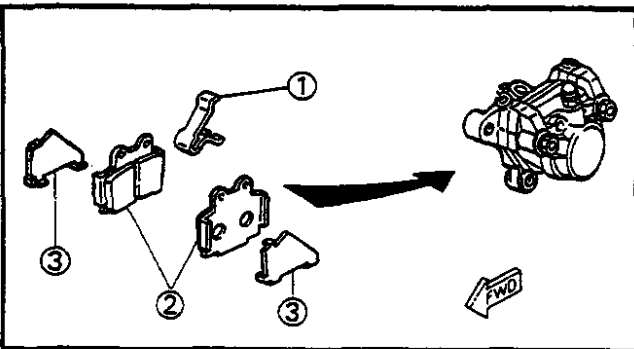

7. Install:
• Pad spring ①
• Brake pads ②
• Shims ③

8. Install:
• Retaining bolts
• Bolts (Brake caliper)

	Retaining Bolts: 10 Nm (1.0 m•kg, 7.2 ft•lb) Bolts (Brake Caliper): 35 Nm (3.5 m•kg, 25 ft•lb)
--	---

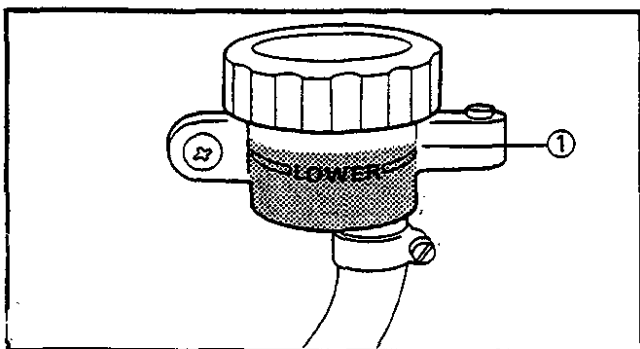

9. Inspect:
• Brake fluid level
Refer to "BRAKE FLUID INSPECTION" section in CHAPTER 3.

① "LOWER" level line

10. Check:

- Brake pedal operation
A softy or spongly filling → Bleed brake system.
Refer to "AIR BLEEDING" section in CHAPTER 3.

CALIPER DISASSEMBLY

NOTE: _____

Before disassembling the front brake caliper or rear brake caliper, drain the brake system of its brake fluid.

Front Brake

1. Remove:

- Brake pads
Refer to "BRAKE PAD REPLACEMENT" section in CHAPTER 7.

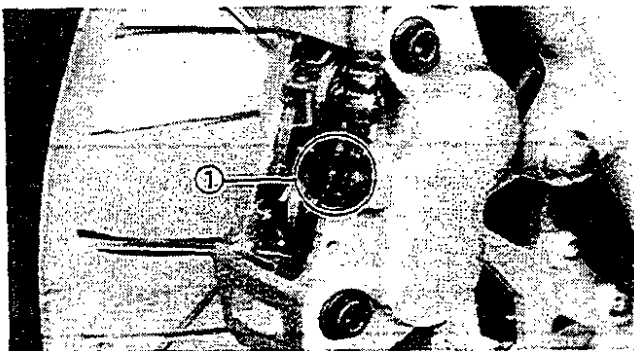

2. Remove:

- Union bolt ①
- Copper washers
- Caliper body

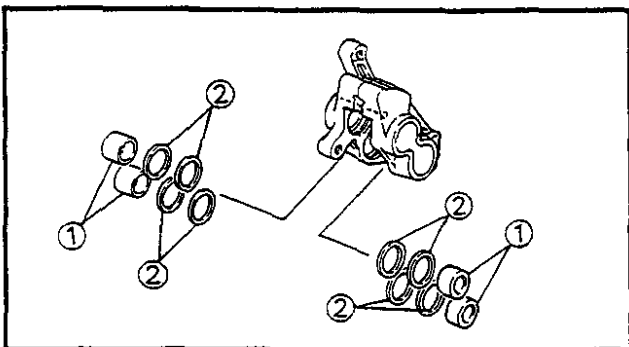

3. Remove:

- Pistons ①
- Piston seals ②

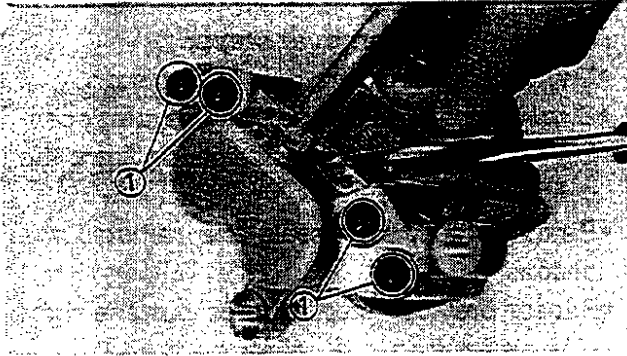

Caliper piston removal steps:

- Using a rag, lock the right side piston.
- Blow compressed air into the hose joint opening to force out the left side piston from the caliper body.
- Remove the piston seals and reinstall the piston.
- Repeat previous step to force out the right side piston from the caliper body.

WARNING:

Do not loosen the bolts ①.

Rear Brake

1. Remove:

- Brake pads

Refer to "BRAKE PAD REPLACEMENT" section in CHAPTER 7.

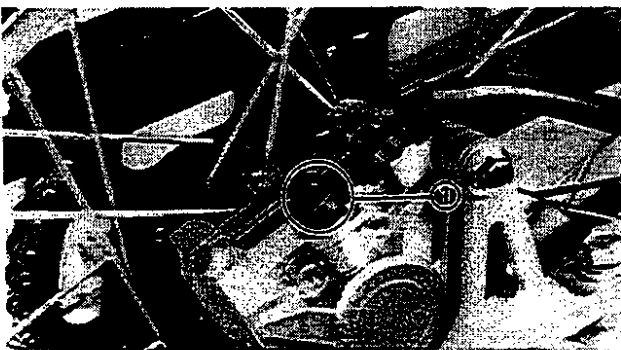

2. Remove:

- Union bolt ①
- Copper washers

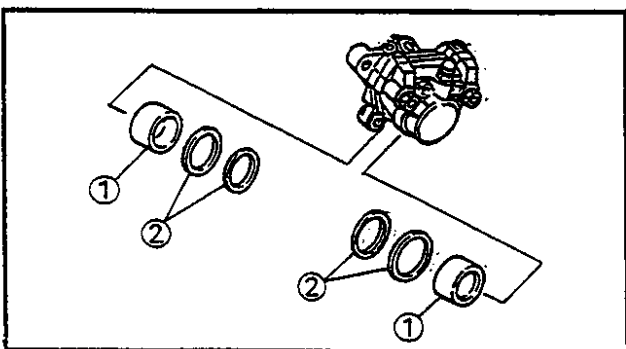

3. Remove:

- Pistons ①
- Piston seals ②

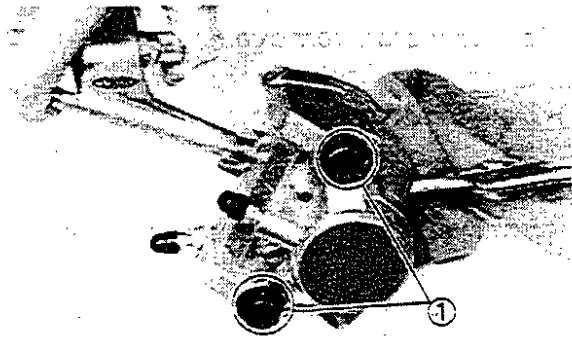

Caliper piston removal steps:

- Using a rag, lock the right side piston.
- Blow compressed air into the hose joint opening to force out the left side piston from the caliper body.
- Remove the piston seals and reinstall the piston.
- Repeat previous step to force out the right side piston from the caliper body.

WARNING: _____

Do not loosen the bolts ①.

MASTER CYLINDER DISASSEMBLY

NOTE: _____

Before disassembling the front or rear brake master cylinders, drain the brake system of its brake fluid.

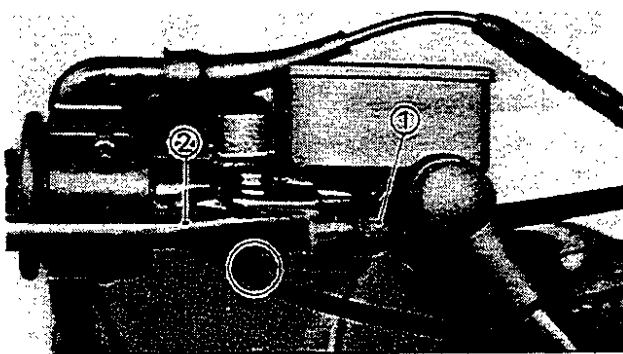

Front Brake

1. Remove:

- Brake switch ①
- Brake lever ②

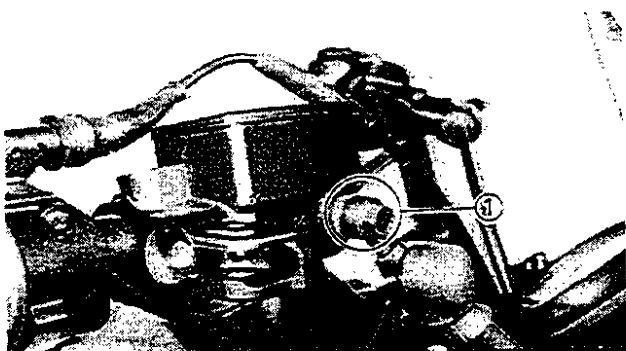

2. Remove:

- Union bolt ①
- Copper washers ②

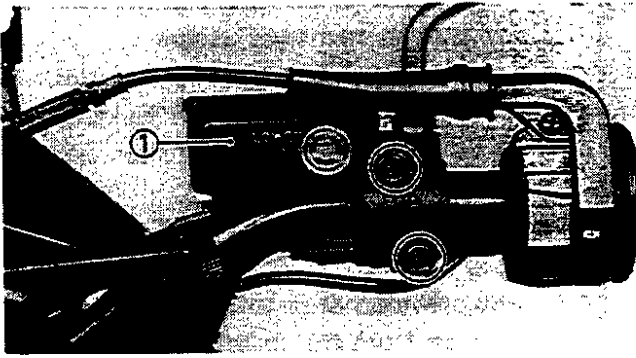

3. Remove:

- Master cylinder assembly ①

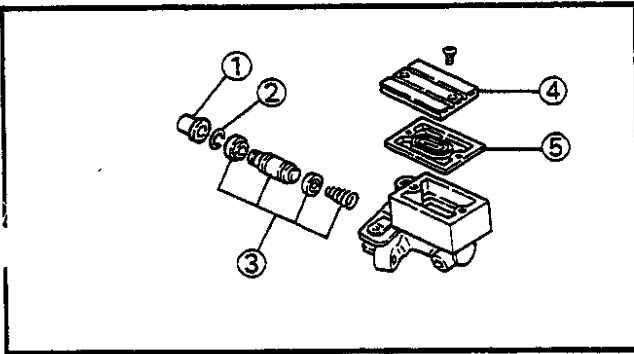

4. Remove:

- Dust boot ①
- Circlip ②
- Master cylinder kit ③
- Master cylinder cap ④
- Rubber seal ⑤

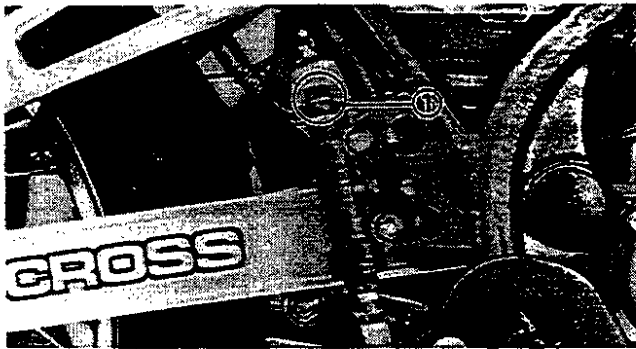

Rear Brake

1. Remove:

- Union bolt ①
- Copper washer

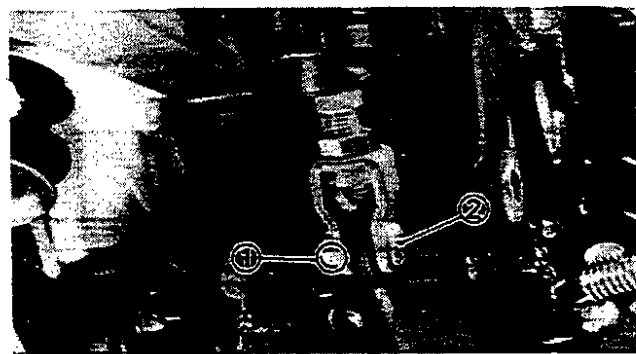

2. Remove:

- Cotter pin ①
- Plain washer
- Pin ②

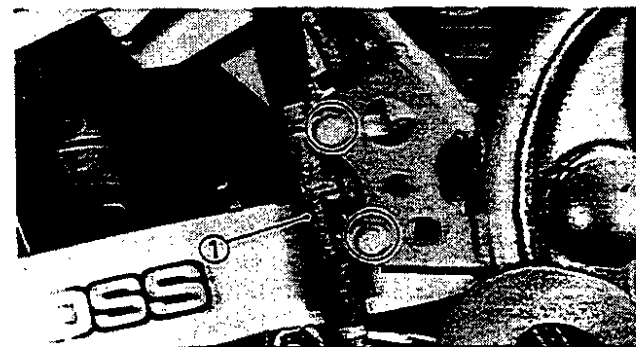

3. Remove:

- Master cylinder assembly ①

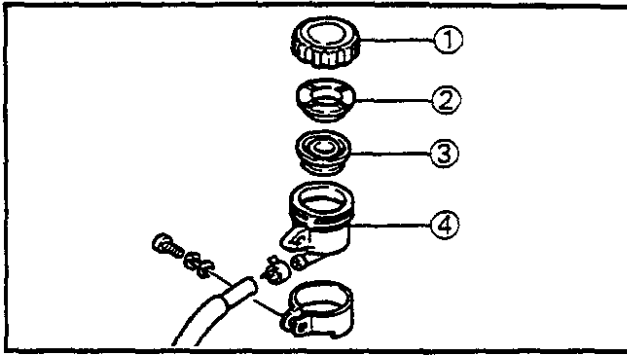

4. Remove:
- Reservoir tank cap ①
 - Bush ②
 - Diaphragm ③
 - Reservoir tank ④

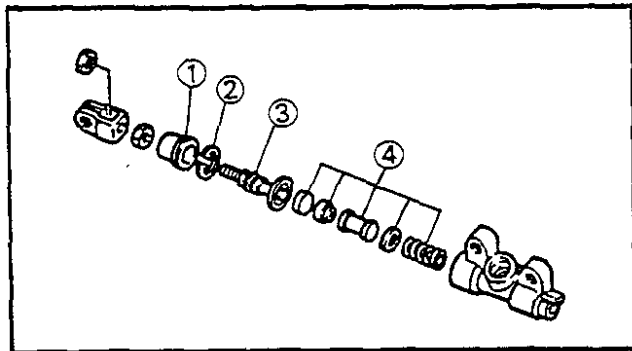

5. Remove:
- Dust boot ①
 - Circlip ②
 - Adjusting rod ③
 - Master cylinder kit ④

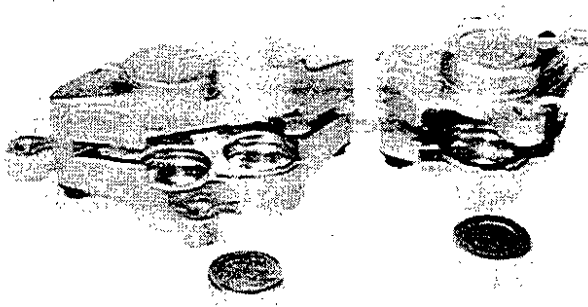

INSPECTION AND REPAIR

1. Inspect:
- Caliper piston
Rust/Wear → Replace.
 - Caliper cylinder body
Wear/Scratches → Replace.

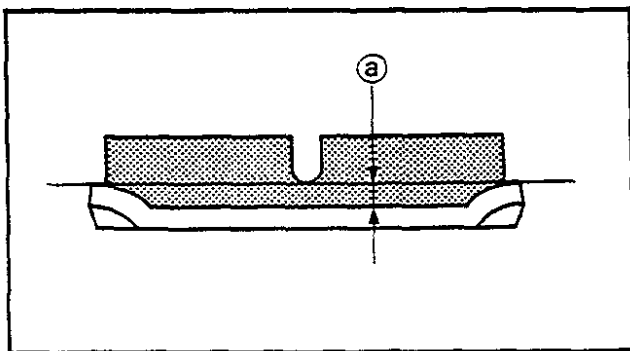

2. Measure:
- Brake pad thickness ①
 - Out of specification → Replace.

	<p>Pad Wear Limit: 0.5 mm (0.02 in)</p>
---	--

NOTE:

Replace the pads as a set if either is found to be worn to the wear limit.

3. Inspect:
- Brake hose
Cracks/Damage → Replace.

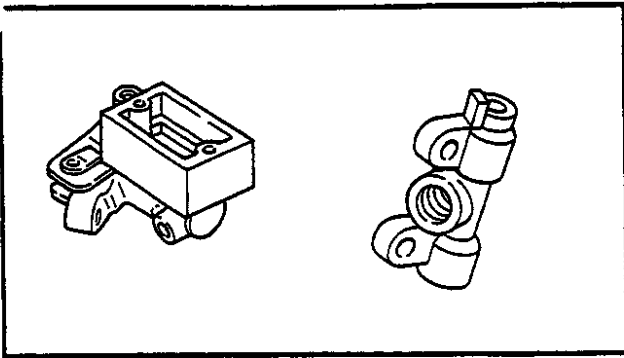

4. Inspect:
- Master cylinder body
 - Scratches/Wear → Replace.

NOTE: _____
 Clean all passages with new brake fluid.

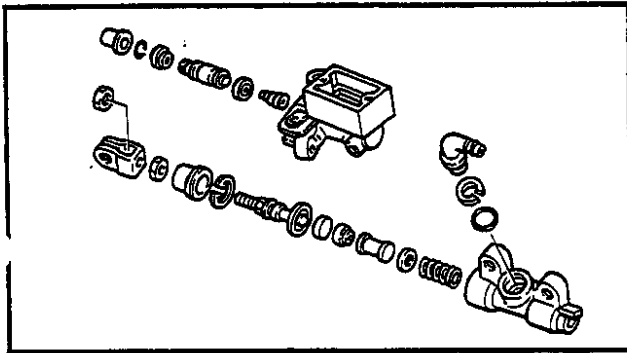

5. Inspect:
- Master cylinder kit
 - Scratches/Wear → Replace.

ASSEMBLY

WARNING: _____

- All internal parts should be cleaned in new brake fluid only.
- Internal parts should be lubricated with brake fluid when installed.



Brake Fluid:
 DOT #4
 If DOT #4 is not available DOT #3 can be used.

- Replace the piston seals whenever a caliper is disassembled.

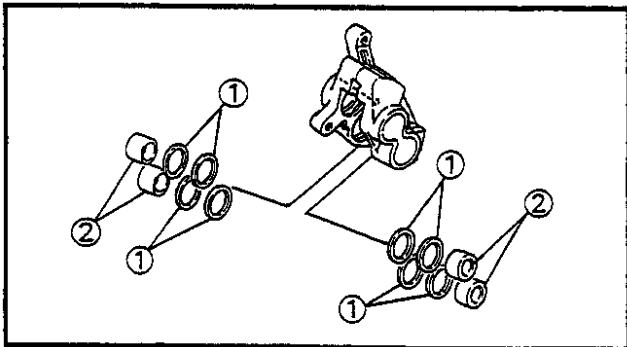

Front Brake

1. Install:
- Piston seals ①
 - Pistons ②
2. Install:
- Brake pads
 - Pad spring
 - Retaining pins
 - Circlips
 - Caliper cover
- Refer to "BRAKE PAD REPLACEMENT" section in CHAPTER 7.

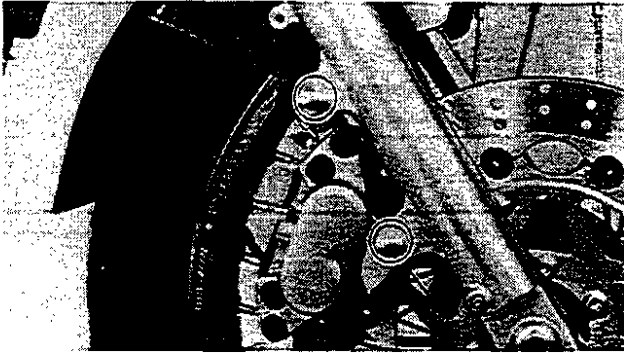

3. Install:
- Brake caliper

	Bolts (Brake Caliper): 35 Nm (3.5 m•kg, 25 ft•lb)
---	---

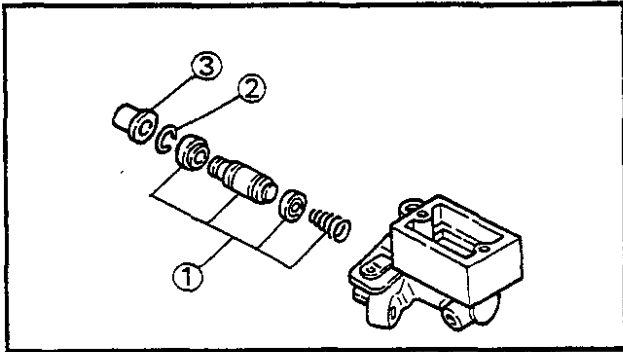

4. Install:
- Master cylinder kit ①
 - Circlip ②
 - Dust boot ③

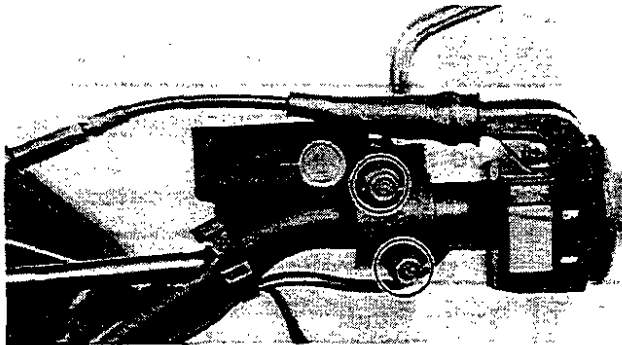

5. Install:
- Master cylinder (Front brake)

	Bolts (Master Cylinder Bracket): 8 Nm (0.8 m•kg, 5.8 ft•lb)
---	---

NOTE: Install the master cylinder bracket with the "UP" mark facing upward.

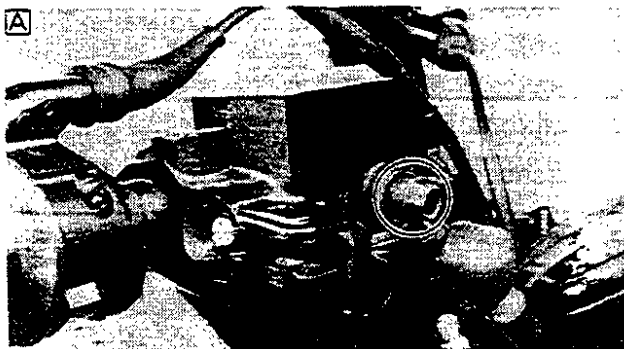

6. Install:
- Brake hose
 - Copper washers
 - Union bolts

	Union Bolts: 26 Nm (2.6 m•kg, 19 ft•lb)
---	---

- A Master cylinder
- B Brake caliper

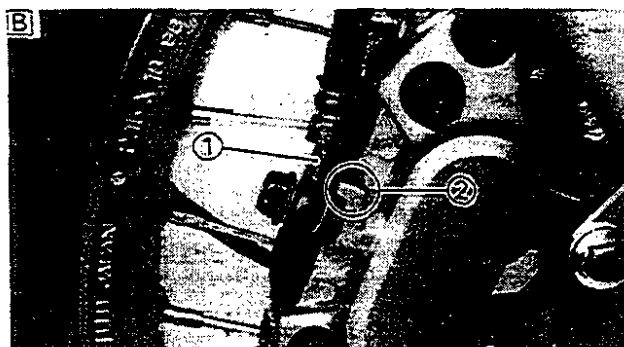

CAUTION: When installing the brake hose to the caliper, lightly touch the brake pipe ① with the projection ② on the caliper.

WARNING: Always use new copper washers.

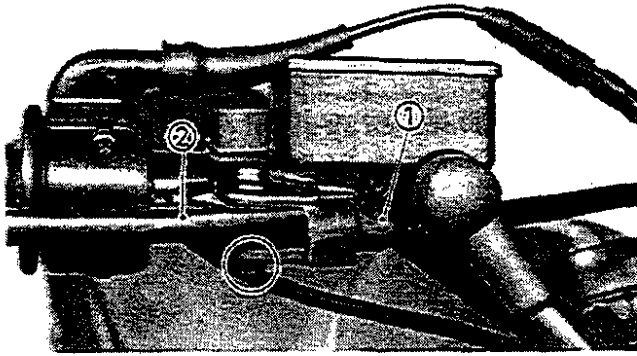

7. Install:
- Brake switch ①
 - Brake lever ②

NOTE:

Apply lithium soap base grease to pivot shaft of brake lever.

8. Fill:
- Brake fluid



Recommended Brake Fluid:
DOT #4
 If DOT #4 is not available DOT #3 can be used.

CAUTION:

Brake fluid may erode painted surfaces or plastic parts. Always clean up spilled fluid immediately.

WARNING:

- Use only the designated quality brake fluid: otherwise, the rubber seals may deteriorate, causing leakage and poor brake performance.
- Refill with the same type of brake fluid; mixing fluids may result in a harmful chemical reaction and lead to poor performance.
- Be careful that water does not enter the master cylinder when refilling. Water will significantly lower the boiling point of the fluid and may result in vapor lock.

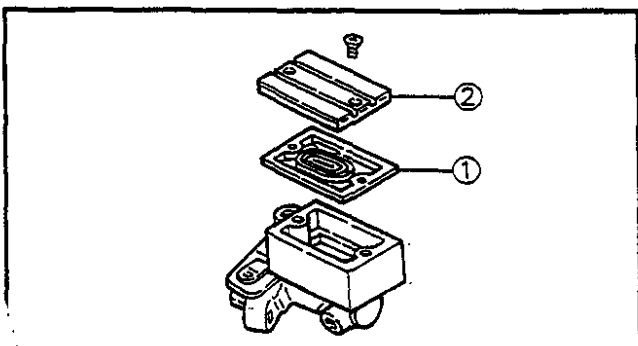

9. Install:
- Rubber seal ①
 - Master cylinder cap ②



Screws (Master Cylinder Cap):
2 Nm (0.2 m•kg, 1.4 ft•lb)

10. Air bleed:

- Brake system
- Refer to "AIR BLEEDING" section in CHAPTER 3.

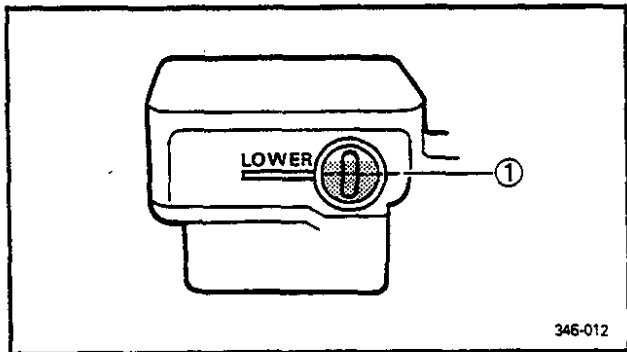

11. Inspect:

- Brake fluid level
- Fluid level is under "LOWER" level line
 ① → Replenish.
- Refer to "BRAKE FLUID INSPECTION" section in CHAPTER 3.

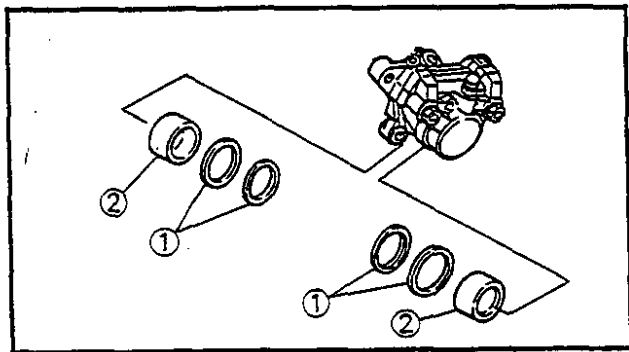

Rear Brake

1. Install:

- Piston seals ①
- Pistons ②

2. Install:

- Brake pads
 - Pad spring
 - Shims
 - Retaining bolts
- Refer to "BRAKE PAD REPLACEMENT" section in CHAPTER 7.

3. Install:

- Brake caliper

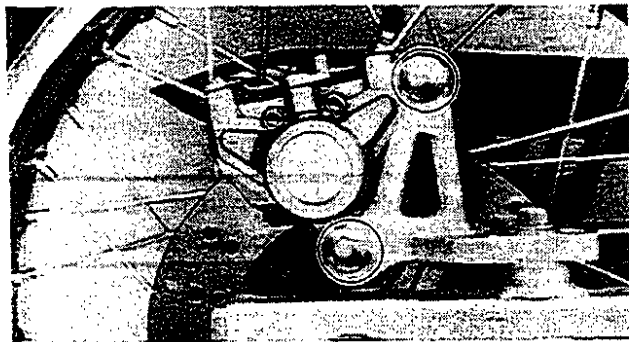

	Bolts (Brake Caliper):
	35 Nm (3.5 m·kg, 25 ft·lb)

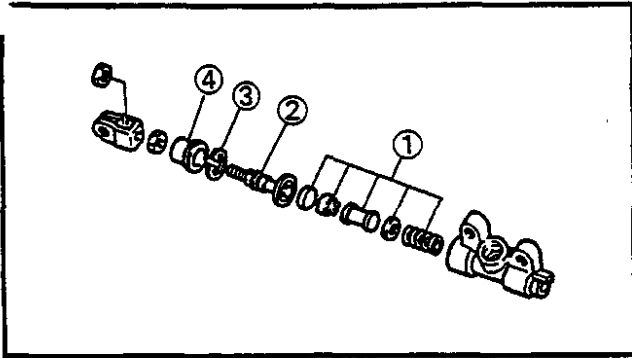

4. Install:
- Master cylinder kit ①
 - Adjusting rod ②
 - Circlip ③
 - Dust boot ④

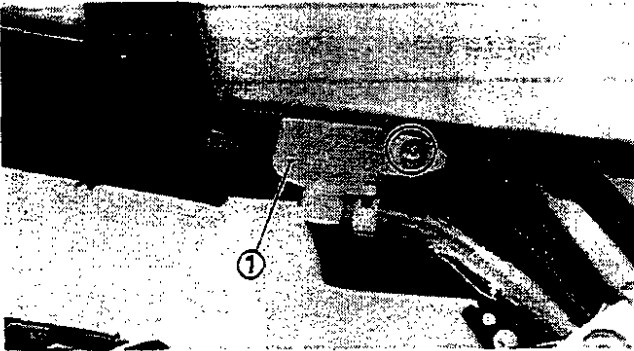

5. Install:
- Reservoir tank ①

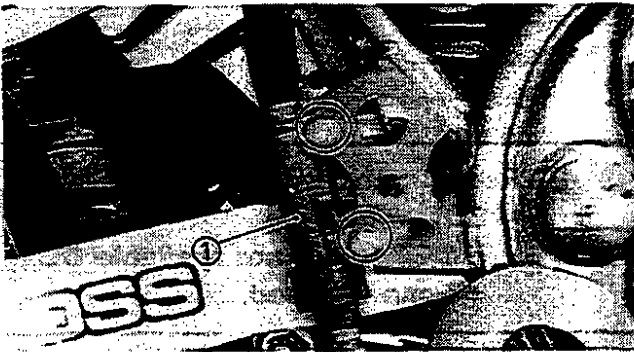

6. Install:
- Master cylinder assembly ①

	Bolts (Master Cylinder Assembly): 35 Nm (3.5 m•kg, 25 ft•lb)
---	--

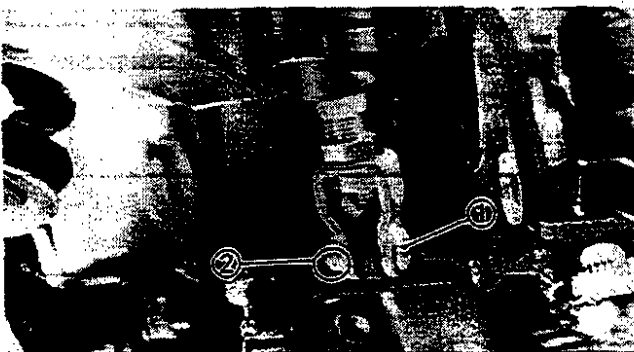

7. Install:
- Pin ①
 - Plain washer
 - Cotter pin ②

WARNING:

Always use new cotter pin.

8. Install:
- Brake hose
 - Copper washers
 - Union bolts

	Union Bolts: 26 Nm (2.6 m•kg, 19 ft•lb)
---	---

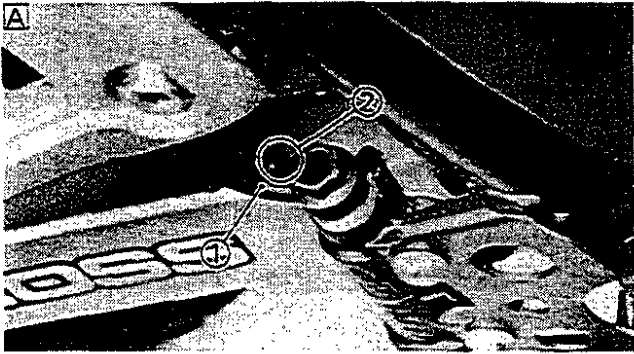

- A** Master cylinder
- B** Brake caliper

CAUTION:

When installing the brake hose, lightly touch the brake pipe ① with the projections ② on the caliper and master cylinder.

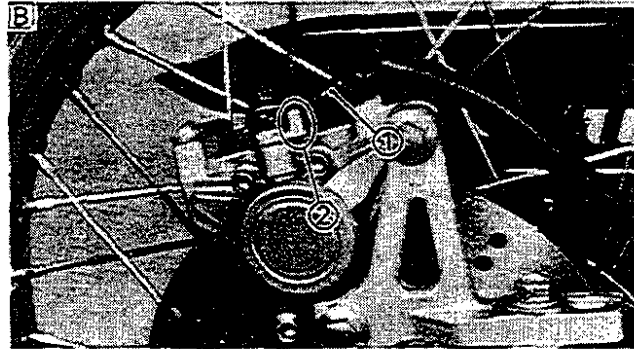

WARNING:

Always use new copper washers.

9. Fill:
 - Brake fluid



Recommended Brake Fluid:
 DOT #4
 If DOT #4 is not available DOT #3 can be used.

CAUTION:

Brake fluid may erode painted surfaces or plastic parts. Always clean up spilled fluid immediately.

WARNING:

- Use only the designated quality brake fluid: otherwise, the rubber seals may deteriorate, causing leakage and poor brake performance.
- Refill with the same type of brake fluid; mixing fluids may result in a harmful chemical reaction and lead to poor performance.
- Be careful that water does not enter the master cylinder when refilling. Water will significantly lower the boiling point of the fluid and may result in vapor lock.

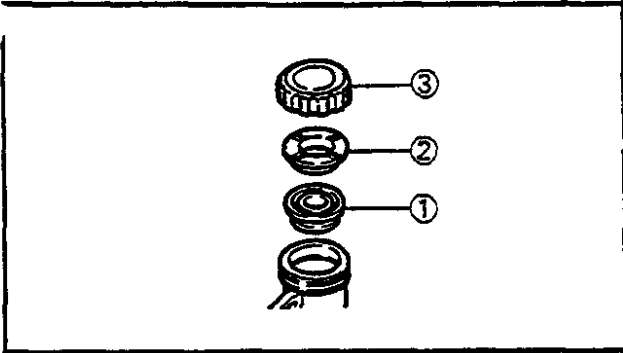

10. Install:

- Diaphragm ①
- Bush ②
- Reservoir tank cap ③

11. Air bleed:

- Brake system
Refer to "AIR BLEEDING" section in CHAPTER 3.

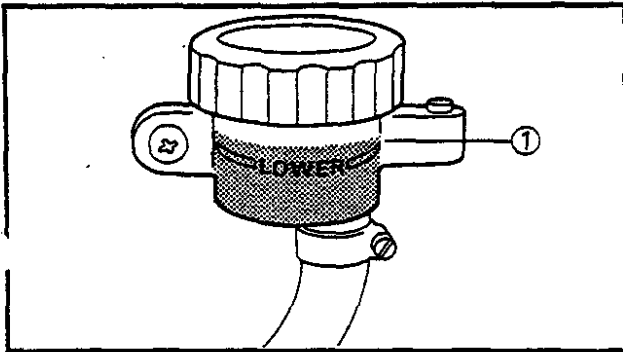

12. Inspect:

- Brake fluid level
Fluid level is under "LOWER" level line
① → Replenish.
Refer to "BRAKE FLUID INSPECTION" section in CHAPTER 3.

FRONT FORK

- ① Cap bolt
- ② O-ring
- ③ Washer
- ④ Fork spring
- ⑤ Rebound spring
- ⑥ Damper rod
- ⑦ Oil lock piece
- ⑧ Inner tube
- ⑨ Retaining clip
- ⑩ Dust seal
- ⑪ Oil seal
- ⑫ Washer
- ⑬ Guide bush
- ⑭ Outer tube
- ⑮ Drain screw
- ⑯ Fork boot

FORK OIL (EACH):
CAPACITY:
A 394 cm³ (13.87 Imp oz, 13.32 US oz)
GRADE:
FORK OIL 10W OR EQUIVALENT

FORK SPRING:
B **MINIMUM FREE LENGTH:**
508 mm (20 in)

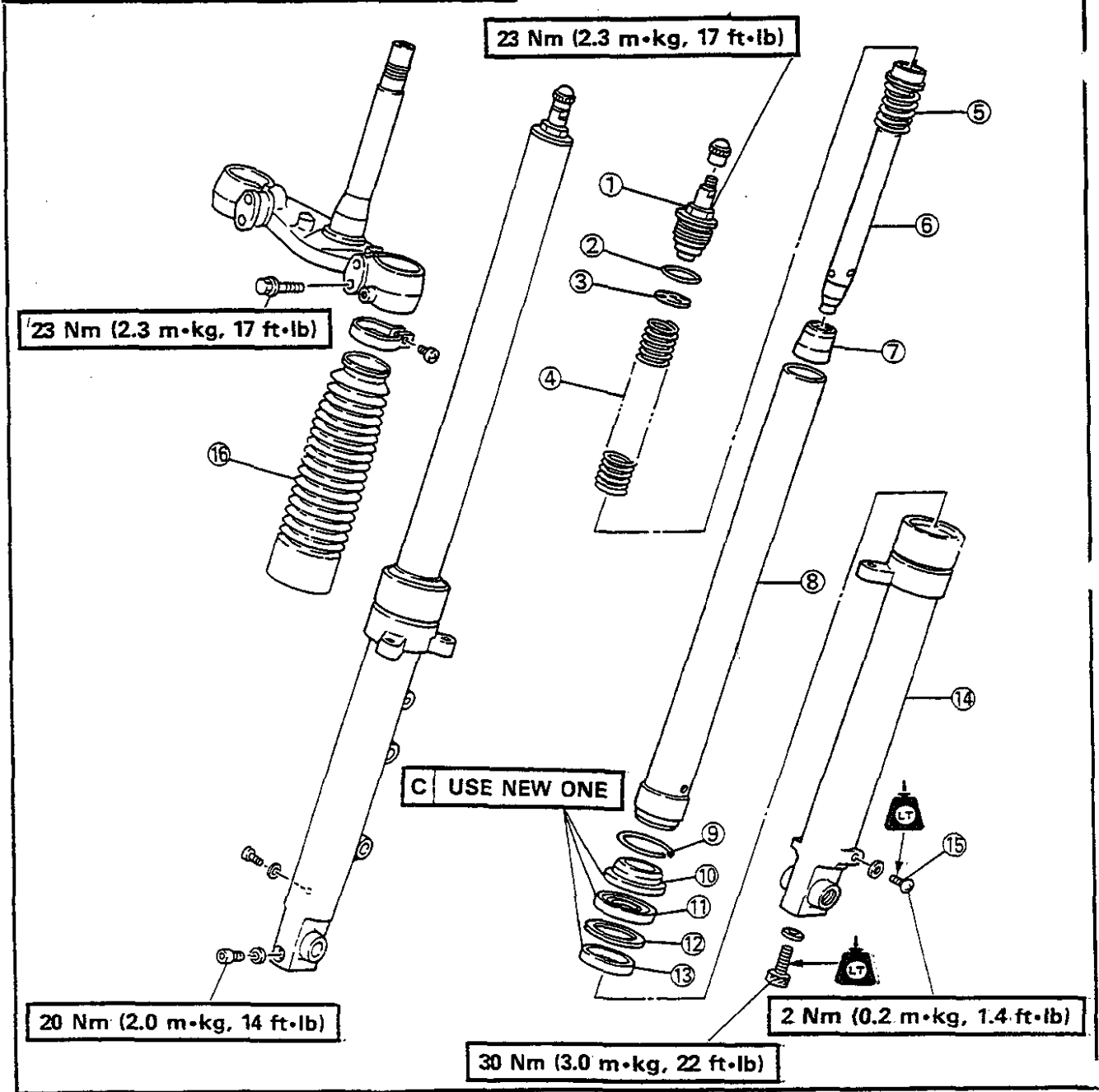

**REMOVAL**

1. Elevate the front wheel by placing a suitable stand under the engine.

WARNING:

Support the motorcycle securely so there is no danger of it falling over.

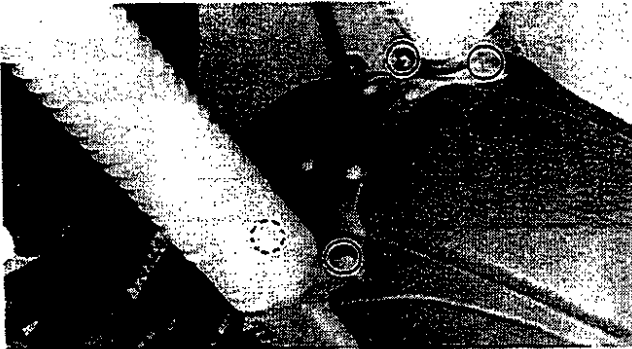

2. Remove:

- Front wheel

Refer to "FRONT WHEEL—REMOVAL" section in CHAPTER 7.

3. Remove:

- Front fender

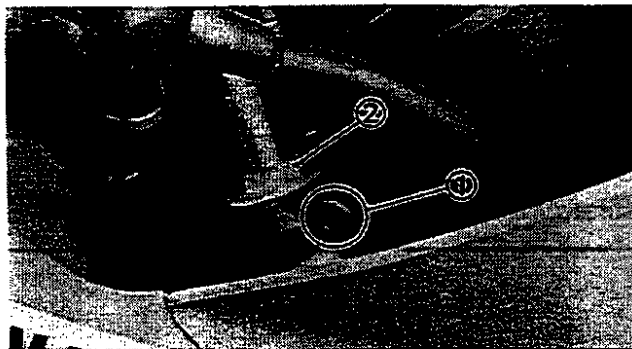

4. Loosen:

- Pinch bolt ① (Handle crown)
- Cap bolt ②

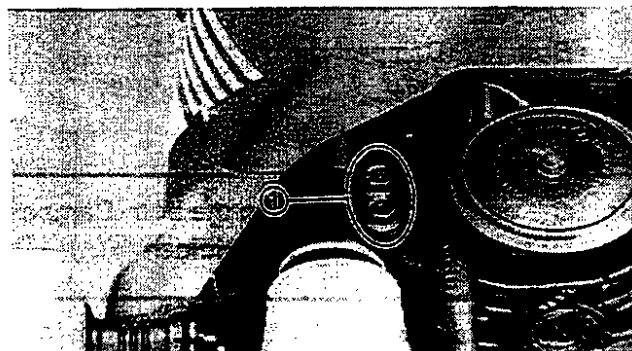

5. Loosen:

- Pinch bolt ① (Lower bracket)

WARNING:

Support the fork before loosening the pinch bolt.

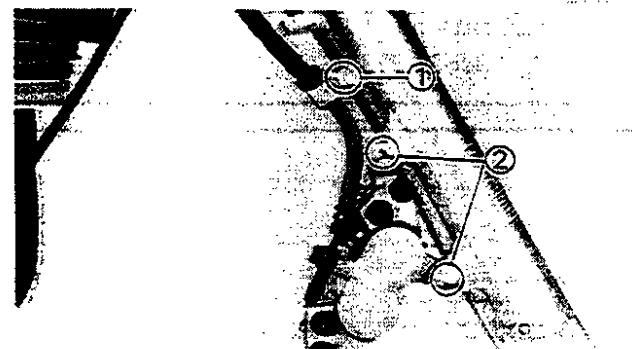
**NOTE:**

When removing the right-hand front fork, remove the bolt ① (Hose clamp) and bolt ② (Brake caliper).

6. Remove:

- Front fork

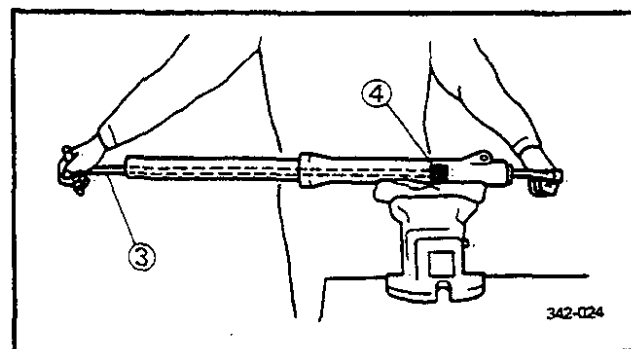
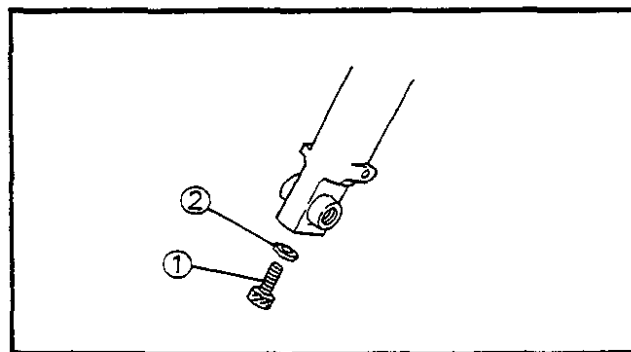
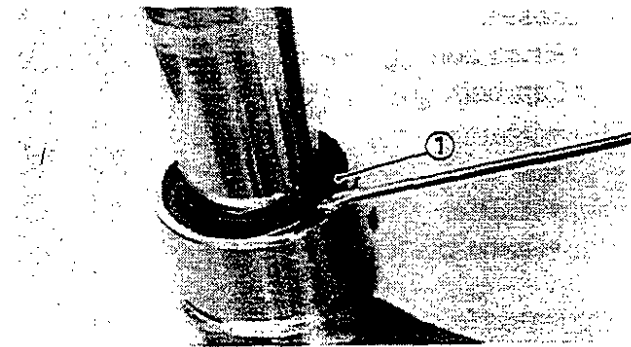
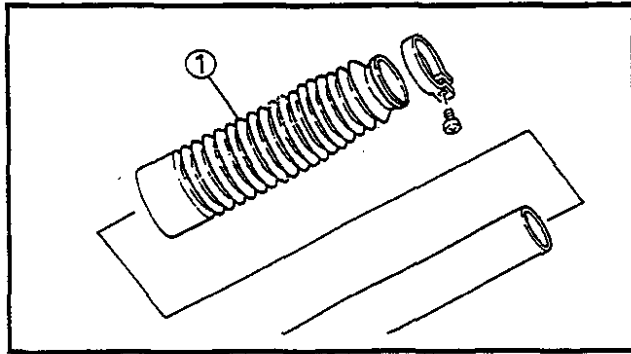
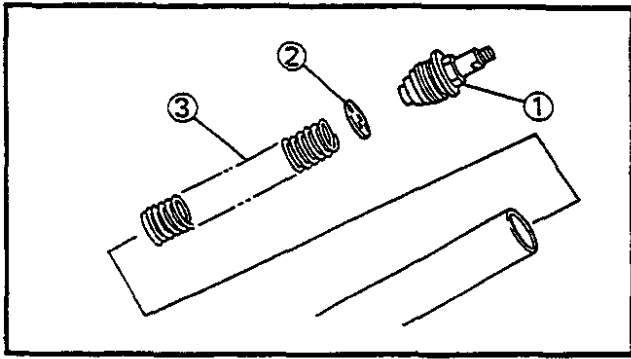

DISASSEMBLY

1. Remove:
 - Cap bolt ①
 - Spring seat ②
 - Fork spring ③

2. Drain:
 - Fork oil

3. Remove:
 - Fork boot ①

4. Remove:
 - Retaining clip ①

NOTE:

Use a thin screwdriver, and be careful not to scratch the inner fork tube.

5. Remove:
 - Bolt ① (Damper rod)
 - Washer ②

NOTE:

Hold the damper rod to loosen the bolt (Damper rod) by the T-Handle ③ and Holder ④.



T-Handle:
90890-01326

Holder:
90890-01328

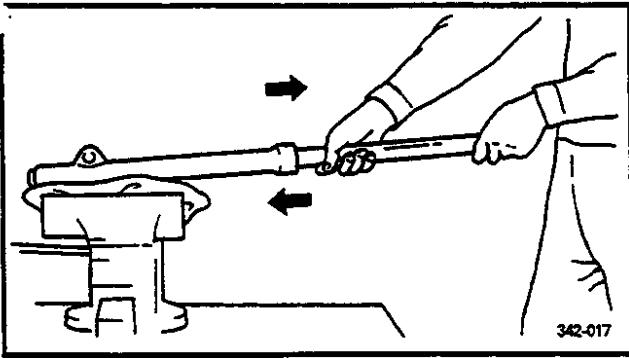

6. Remove:
- Inner fork tube

Removal steps:

- Hold the fork leg horizontally.
- Pull out the inner fork tube from the outer tube by forcefully, but carefully, withdrawing the inner fork tube.

CAUTION:

Avoid bottoming the inner tube in the outer tube during the above procedure, as the oil lock piece will be damaged.

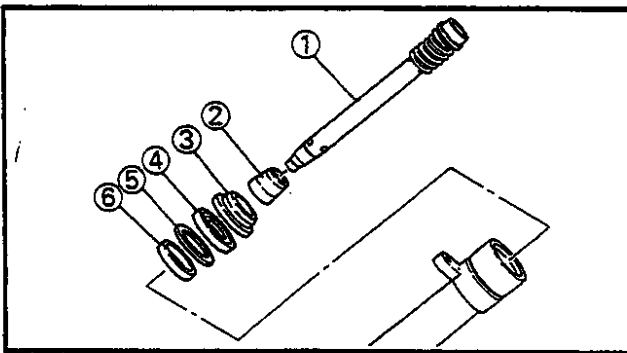

7. Remove:
- Damper rod ①
 - Oil lock pieces ②
 - Dust seal ③
 - Oil seal ④
 - Washer ⑤
 - Guide bush ⑥

INSPECTION

1. Inspect:
- Inner fork tube ①
 - Outer fork tube ②
- Scratches/Bends/Damage → Replace.

WARNING:

Do not attempt to straighten a bent inner fork tube as this may dangerously weaken the tube.

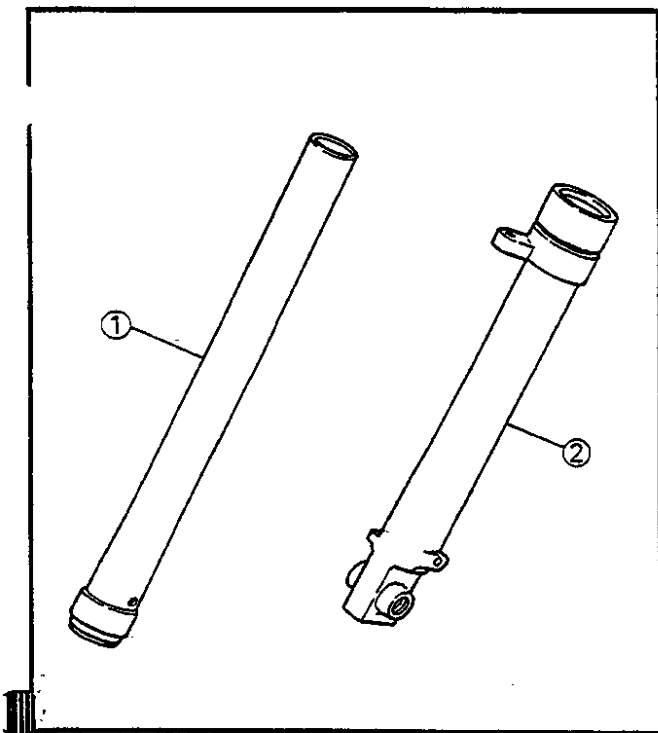

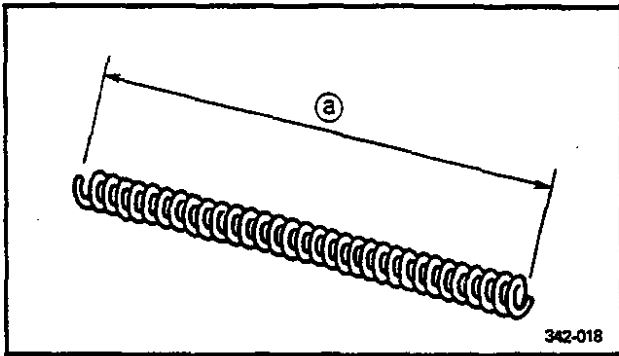

2. Measure:

- Fork spring free length (a)
Out of specification → Replace.



Fork Spring Free Length:
513.5 mm (20.2 in)
Minimum Free Length:
508 mm (20.0 in)

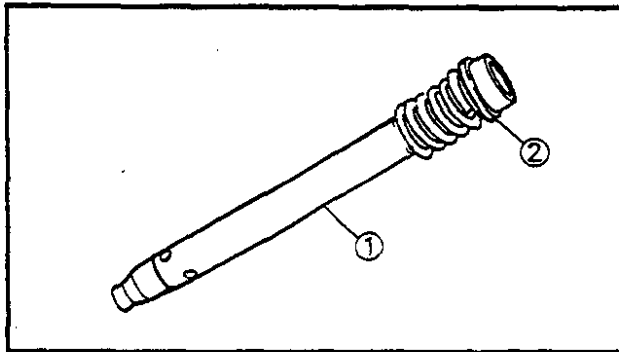

3. Inspect:

- Damper rod (1)
Wear/Damage → Replace.
Contamination → Blow out all oil passages with compressed air.
- Piston ring (2)
Wear/Damage → Replace.

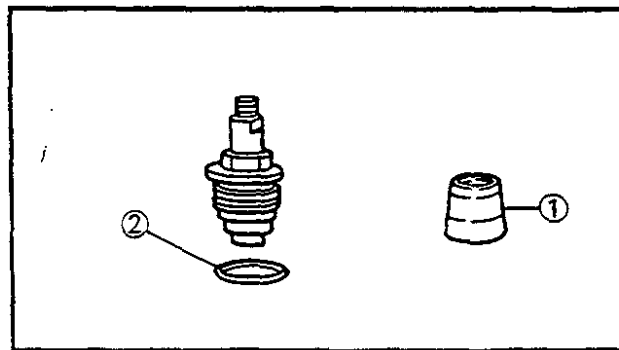

4. Inspect:

- Oil lock piece (1)
- O-ring (2) (Cap bolt)
Damage → Replace.

ASSEMBLY

Reverse the "DISASSEMBLY" procedure.
Note the following points.

NOTE:

- In front fork reassembly, be sure to use following new parts.
 - * Guide bush
 - * Oil seal
 - * Dust seal
- Make sure all components are clean before reassembly.

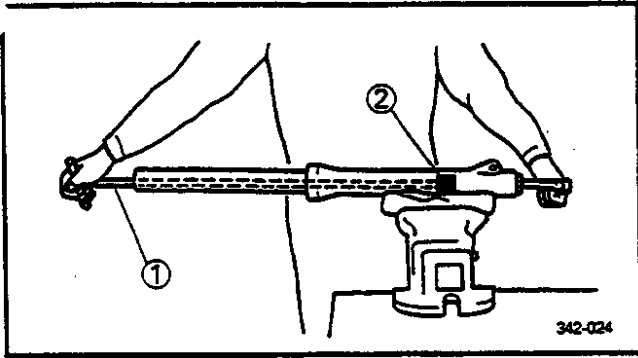

1. Tighten:
 • Bolt (Damper rod)

 **Bolt (Damper Rod):**
 30 Nm (3.0 m•kg, 22 ft•lb)
 Apply LOCTITE®.

NOTE:
 Hold the damper rod to tighten the bolt (Damper rod) by the T-Handle ① and Holder ②.

 **T-Handle:**
 90890-01326
Holder:
 90890-01328

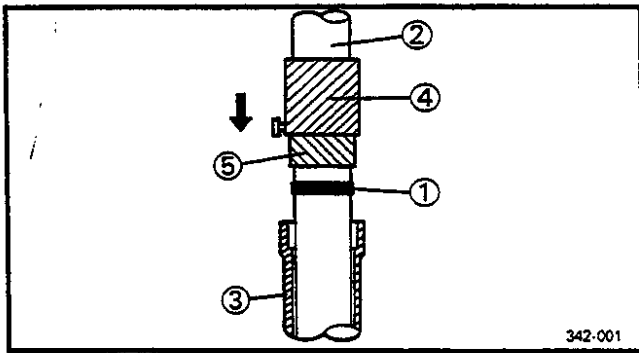

2. Install:
 • Guide bush ①
 Use the Fork Seal Driver Weight ④ and Adapter ⑤.

- ② Inner fork tube
 ③ Outer fork tube

 **Fork Seal Driver Weight:**
 90890-01367
Adapter:
 90890-01372

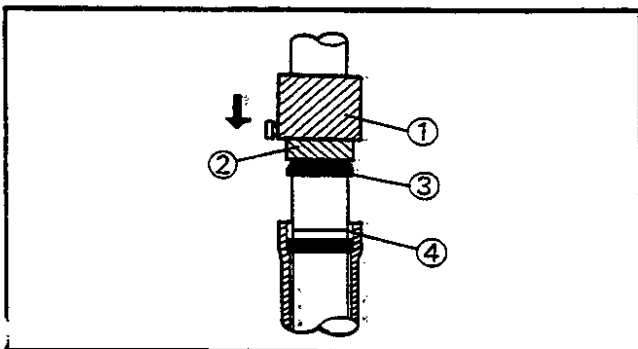

3. Install:
 • Oil seal ③
 Use the Fork Seal Driver Weight ① and Adapter ②.

- ④ Washer

 **Fork Seal Driver Weight:**
 90890-01367
Adapter:
 90890-01372

4. Fill:
- Front fork



Fork Oil Capacity:
 394 cm³ (13.87 Imp oz,
 13.32 US oz)
Grade:
 Fork Oil 10W or Equivalent

NOTE:

After filling the front fork with fork oil, slowly pump the front fork up and down to distribute oil.

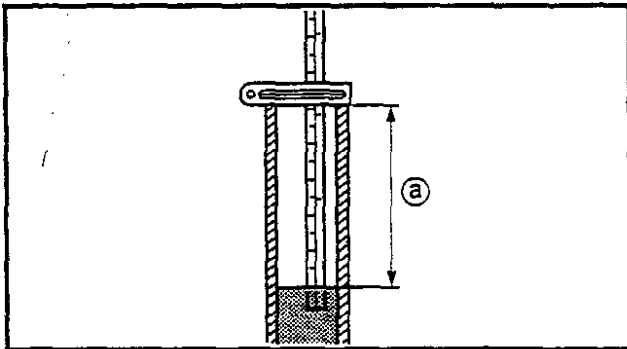

5. Measure:

- Oil level (a)
- Out of specification → Add or reduce oil.



Oil Level:
 115 mm (4.53 in)
 From the top of the inner fork
 tube.

NOTE:

- When measuring the oil level, fully compress the inner fork tube without fork spring.
- Place the front fork on upright position.

6. Before installing the front fork, temporary tighten the cap bolt.

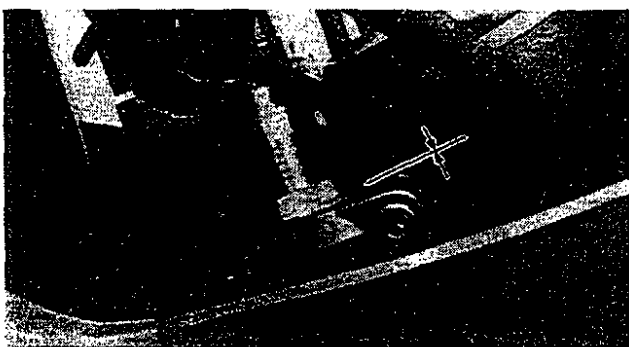
**INSTALLATION**

Reverse the "REMOVAL" procedure.
 Note the following points.

1. Install:
- Front fork
- Temporary tighten the pinch bolts.

NOTE:

Install the front fork until the top of the inner fork tube is flush with the top of the handlebar crown:

**2. Tighten:**

- Pinch bolt (Lower bracket)
- Cap bolt
- Pinch bolt (Handlebar crown)



Pinch Bolt (Lower Bracket):
23 Nm (2.3 m•kg, 17 ft•lb)

Cap Bolt:

23 Nm (2.3 m•kg, 17 ft•lb)

Pinch Bolt (Handlebar Crown):

25 Nm (2.5 m•kg, 18 ft•lb)

3. Install:

- Front wheel

Refer to "FRONT WHEEL—INSTALLATION" section in CHAPTER 7.

4. Adjust:

- Front fork air pressure
- Front fork spring preload

Refer to "FRONT FORK ADJUSTMENT" in CHAPTER 3.

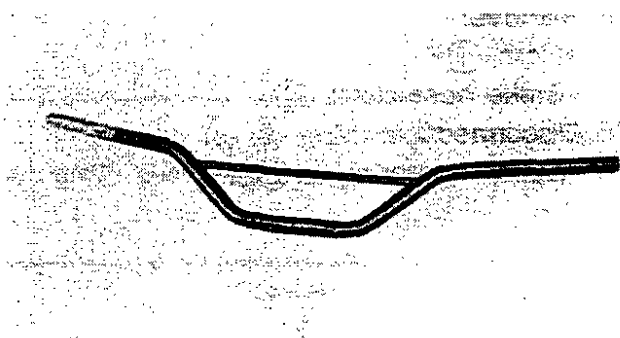

3. Inspect:

- Handlebars

Bends/Cracks/Damage → Replace.

WARNING:

Do not attempt to straighten a bent handlebar as this may dangerously weaken the handlebar.

Handlebar replacement steps:

- Remove the handlebar grip and lever holder.
- Install the lever holder to a new handlebar.
- Apply a light coat of an adhesive for rubber on the left handlebar end.
- Install the handlebar grip.

NOTE:

Wipe off excess adhesive with a clean rag.

WARNING:

Leave the handlebar intact until the adhesive becomes dry enough to make the grip and handlebar stuck securely.

INSTALLATION

Reverse the "REMOVAL" procedure. Note the following points.

1. Apply:

- Wheel bearing grease
To the bearing.

2. Install:

- Lower bracket

WARNING:

Hold the under bracket until it is secured.

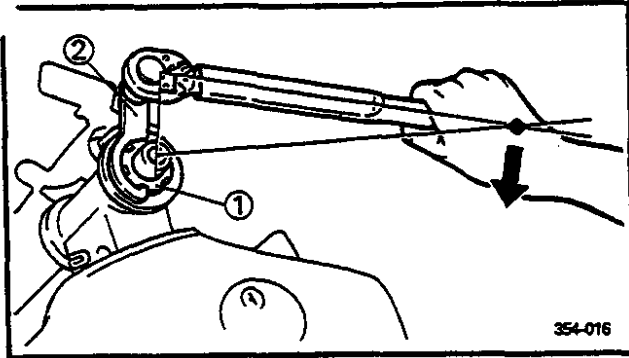

3. Tighten:
- Ring nut ①

Ring nut tightening steps:

- Tighten the ring nut using the Ring Nut Wrench ②.



Ring Nut Wrench:
90890-01403

NOTE: _____

Set the torque wrench to the ring nut wrench so that they form a right angle.



Ring Nut (Initial Tightening):
38 Nm (3.8 m•kg, 27 ft•lb)

- Loosen the ring nut one turn.
- Retighten the ring nut using the Ring Nut Wrench.

WARNING: _____

Avoid over-tightening.



Ring Nut (Final Tightening):
11 Nm (1.1 m•kg, 8.0 ft•lb)

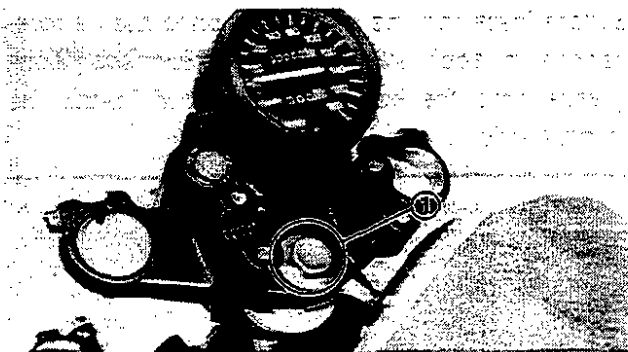

4. Install:
- Handlebar crown

NOTE: _____

Temporary tighten the steering fitting bolt ①.

5. Install:
- Front fork
- Refer to the "FRONT FORK—INSTALLATION" section in CHAPTER 7.



Pinch Bolt (Lower Bracket):
23 Nm (2.3 m•kg, 17 ft•lb)

Pinch Bolt (Handlebar Crown):
25 Nm (2.5 m•kg, 18 ft•lb)

6. Tighten:
- Steering fitting bolt



Steering Fitting Bolt:
70 Nm (7.0 m•kg, 50 ft•lb)

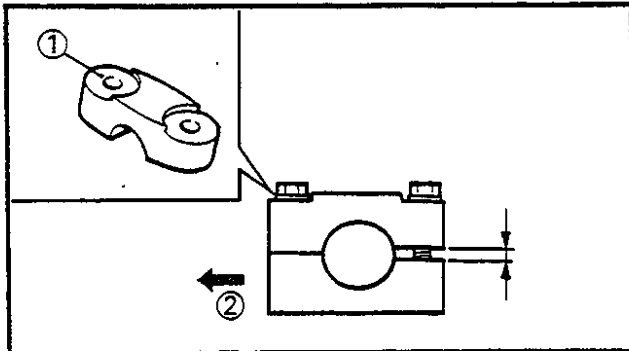

7. Install:
- Handlebars



Bolt (Handlebars):
15 Nm (1.5 m•kg, 11 ft•lb)

NOTE: _____
The upper handlebar holder should be installed with the punched mark ① forward.

② Forward

CAUTION: _____

First tighten the bolts on the front side of the handlebar holder, and then tighten the bolts on the rear side.

NOTE: _____
Before installing the handlebar onto the handlebar crown, apply a light coat of lithium soap base grease onto the handlebar end and install the throttle grip to the handlebar.

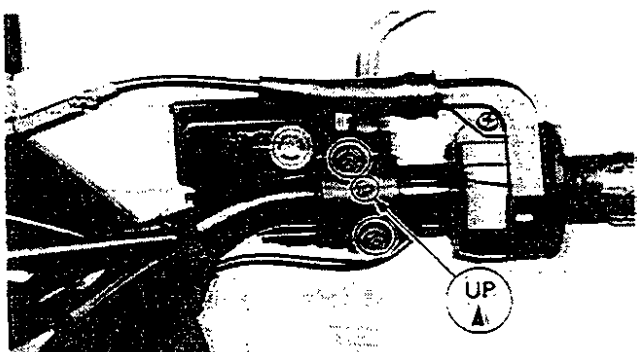

8. Install:
- Brake master cylinder

NOTE: _____
•Install the master cylinder bracket with the "UP" mark facing upward.
•Tighten first the upper bolt, then the lower bolt.



Bolts (Master Cylinder Bracket):
10 Nm (1.0 m•kg, 7.2 ft•lb)

9. Connect:

- Clutch cable

NOTE: _____

Apply a light coat of lithium soap base grease onto the clutch cable end.

10. Install:

- Front wheel

Refer to "FRONT WHEEL—INSTALLATION" section in CHAPTER 7.



Axle Nut:

60 Nm (6.0 m•kg, 43 ft•lb)

Nut (Axle Holder):

20 Nm (2.0 m•kg, 14 ft•lb)

11. Adjust:

- Clutch cable free play



Free Play:

10 ~ 15 mm (0.39 ~ 0.59 in)

At Lever End.

Refer to "CLUTCH ADJUSTMENT" section in CHAPTER 3.

REAR SHOCK ABSORBER AND SWINGARM

- | | |
|------------------|-----------------------|
| ① Swingarm | ⑪ Collar |
| ② Connecting arm | ⑫ Oil seal |
| ③ Relay arm | ⑬ Bush |
| ④ Bearing | ⑭ Collar |
| ⑤ Bush | ⑮ Oil seal |
| ⑥ Oil seal | ⑯ Bush |
| ⑦ Bush | ⑰ Collar |
| ⑧ Collar | ⑱ Bush |
| ⑨ Oil seal | ⑲ Rear shock absorber |
| ⑩ Bush | |

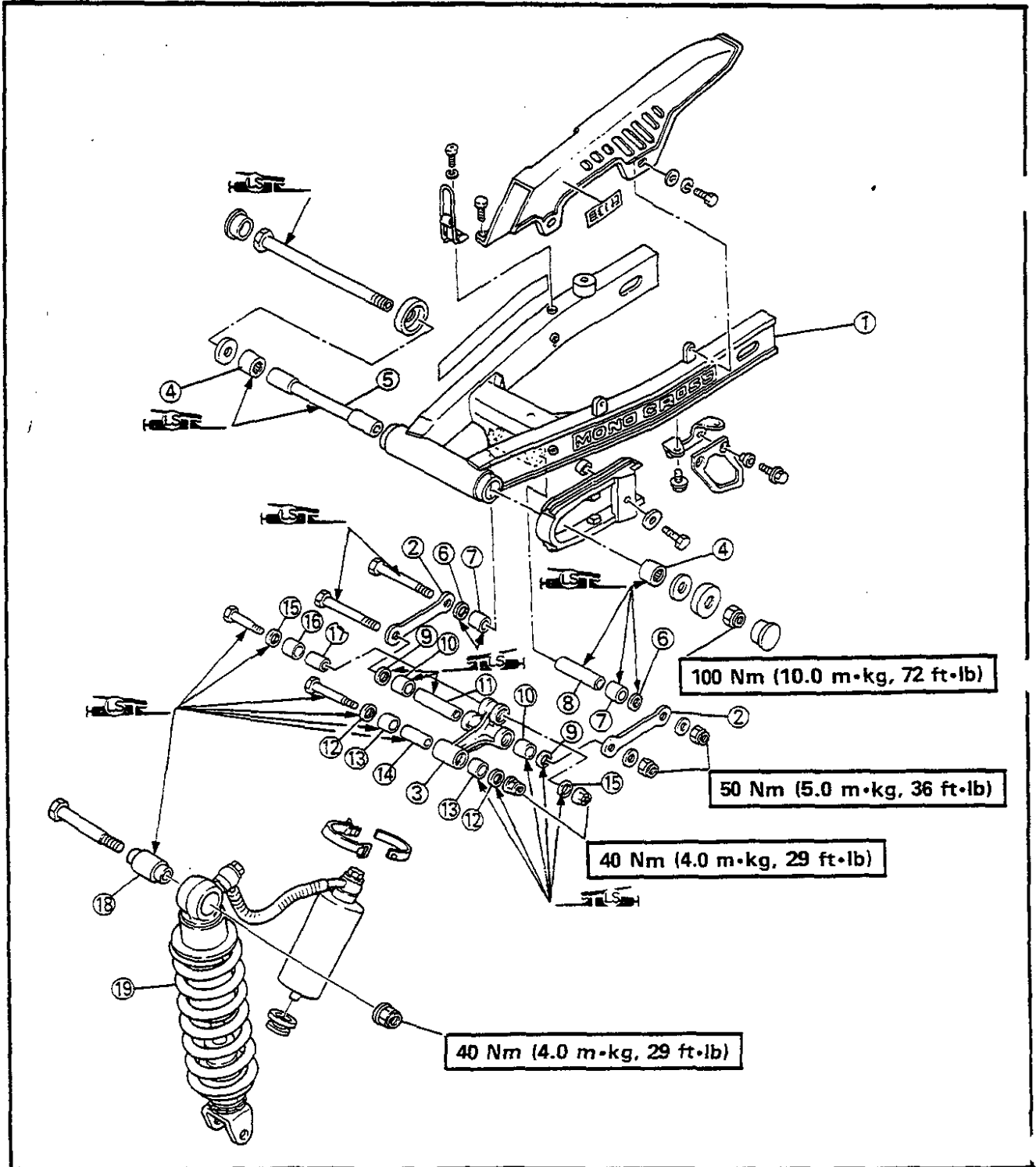

HANDLING NOTES

WARNING:

This shock absorber contains highly pressurized nitrogen gas. Read and understand the following information before handling the shock absorber. The manufacturer cannot be held responsible for property damage or personal injury that may result from improper handling.

- Do not tamper with or attempt to open the cylinder assembly.
- Do not subject shock absorber to an open flame or other high heat source. This may cause the unit to explode due to excessive gas pressure.
- Do not deform or damage the cylinder in any way. Cylinder damage will result in poor damping performance.
- Take care not to scratch the contact surface of the piston rod with the cylinder; or oil could leak out.
- When scrapping the shock absorber, Refer to the "NOTES ON DISPOSAL" section.

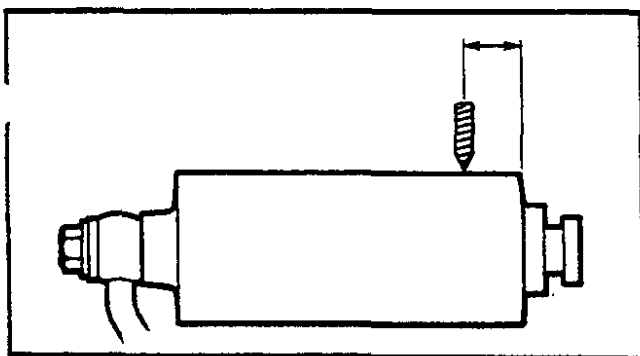

NOTES ON DISPOSAL

Shock absorber disposal steps:

Gas pressure must be released before disposing of shock absorber. To do so, drill a 2~3 mm (0.08~0.12 in) hole through the cylinder wall at a point 15~20 mm (0.6~0.8 in) from the end of the gas chamber.

WARNING:

Wear eye protection to prevent eye damage from escaping gas and/or metal chips.

STEERING HEAD AND HANDLEBARS

- | | |
|--------------------------|------------------------|
| ① Handlebar grip (Right) | ⑦ Bearing race cover |
| ② Handlebar | ⑧ Bearing race |
| ③ Handlebar grip (Left) | ⑨ Ball bearing |
| ④ Handlebar holder | ⑩ Bearing race |
| ⑤ Handlebar crown | ⑪ Taper roller bearing |
| ⑥ Ring nut | |

A BALL BEARING SIZE:
3/16 in
QUANTITY:
22 pcs.

B TIGHTENING STEPS:

- Tighten ring nut
38 Nm (3.8 m•kg,
27 ft•lb).
- Loosen it one turn.
- Retighten it 11 Nm
(1.1 m•kg, 8.0 ft•lb).

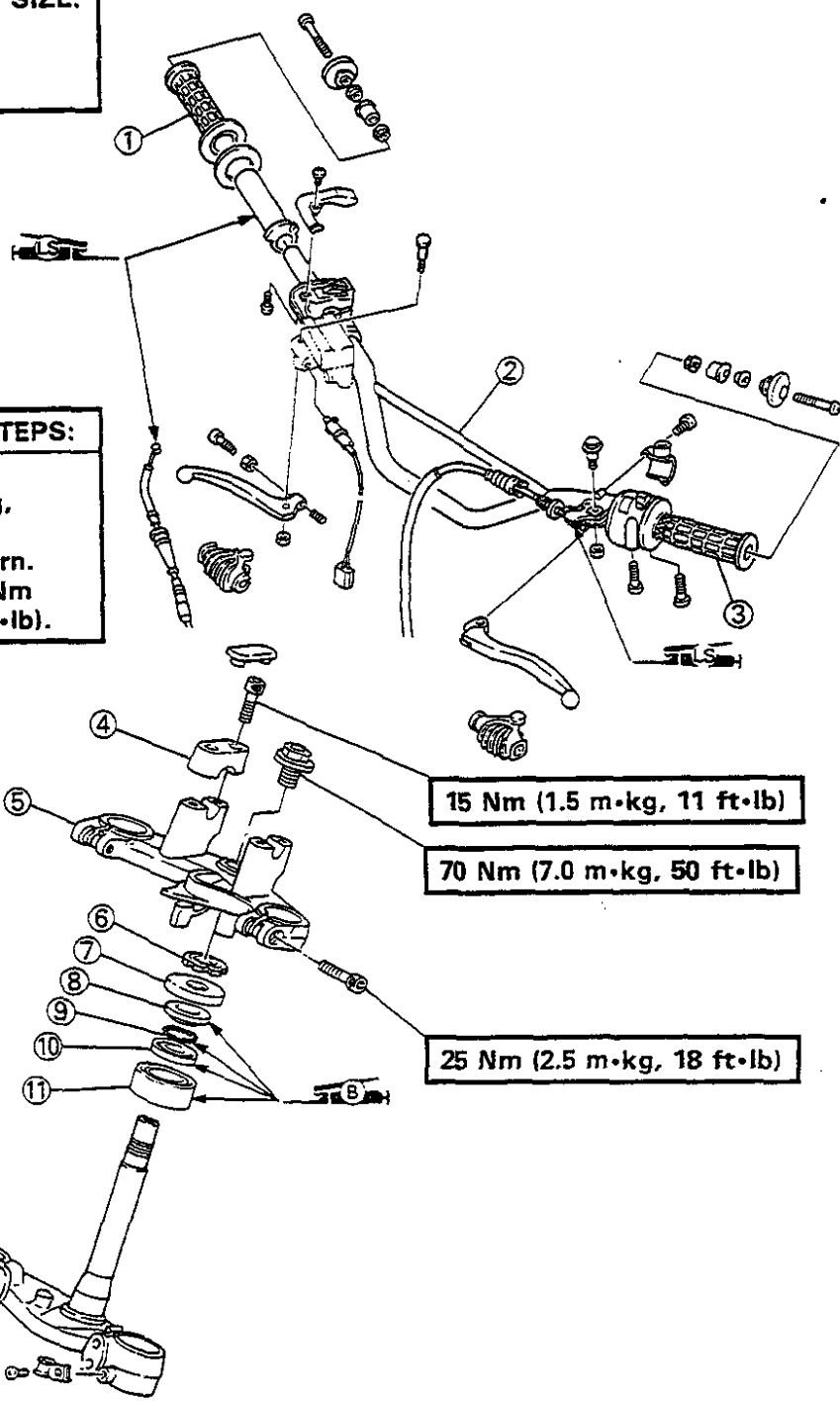



REMOVAL

1. Remove:
 - Upper cowling
 - Lower cowling (Right)
 - Lower cowling (Left)
 Refer to "COWLINGS" section in CHAPTER 3.
2. Elevate the front wheel by placing a suitable stand under the engine.

WARNING:

Securely support the motorcycle so there is no danger of it falling over.

3. Remove:
 - Front wheel
 Refer to "FRONT WHEEL—REMOVAL" section in CHAPTER 7.

4. Remove:
 - Bolts ① (Master cylinder bracket)

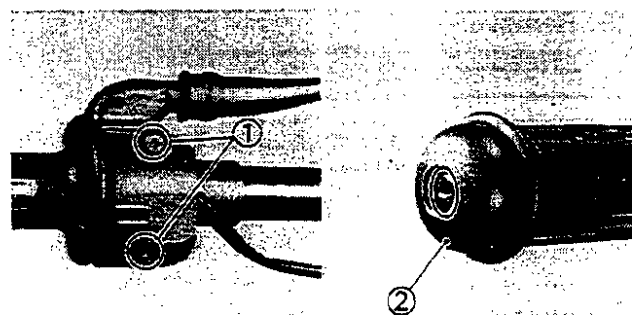
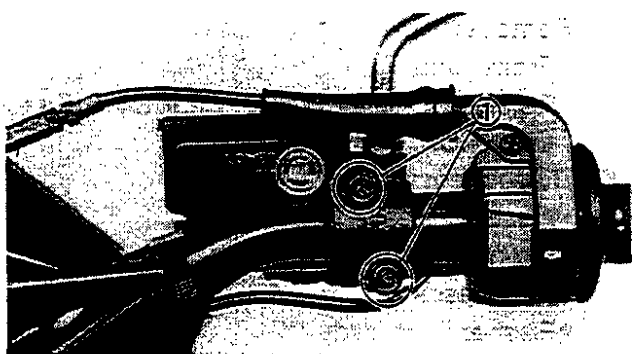

5. Loosen:
 - Screws ① (Right-hand handlebar switch)

6. Remove:
 - Handlebar grip end ②

7. Loosen:
 - Locknut ①
 - Adjuster ②

8. Disconnect:
 - Clutch cable ③

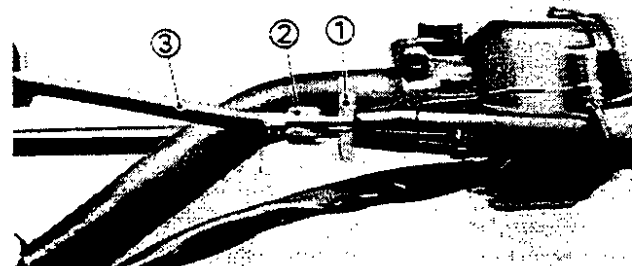

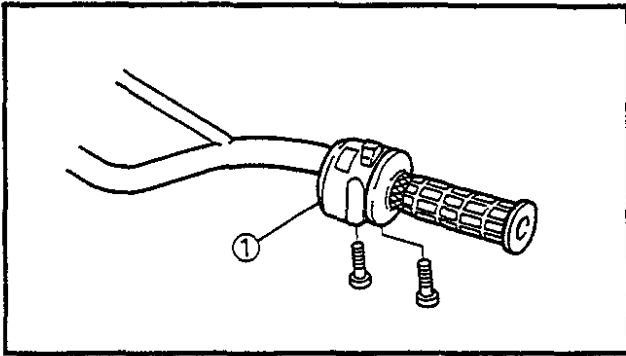

9. Remove:
- Handlebar switch ① (Left)

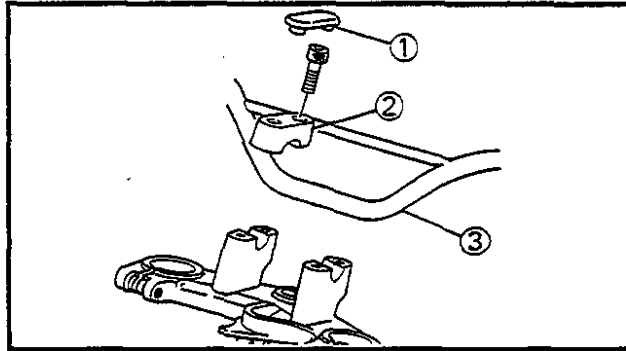

10. Remove:
- Cap ①
 - Handlebar holder ②
 - Handlebars ③

11. Remove:
- Front forks
- Refer to "FRONT FORK—REMOVAL" section in CHAPTER 7.

12. Disconnect:
- Headlight leads
 - Indicator light leads
 - Horn leads
 - Flasher light leads
 - Main switch leads

13. Remove:
- Headlight unit ①

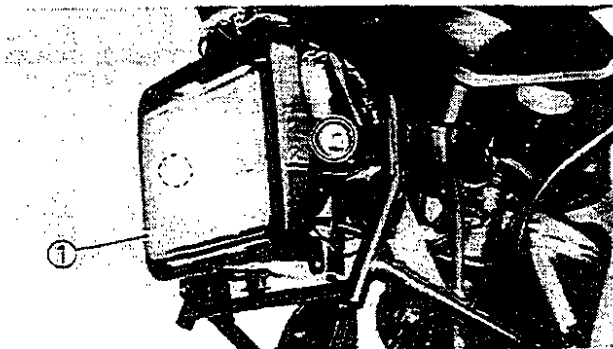

14. Remove:
- Headlight stay ①

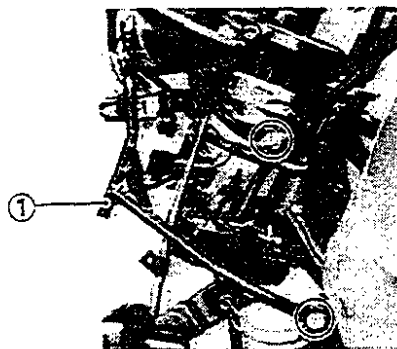

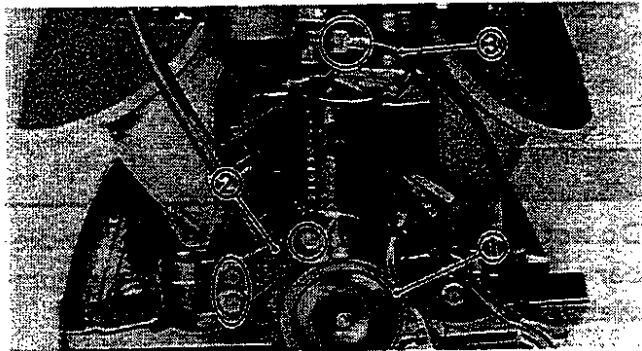

15. Remove:
- Horn ①
 - Brake hose clamp ②
16. Disconnect:
- Speedometer cable ③

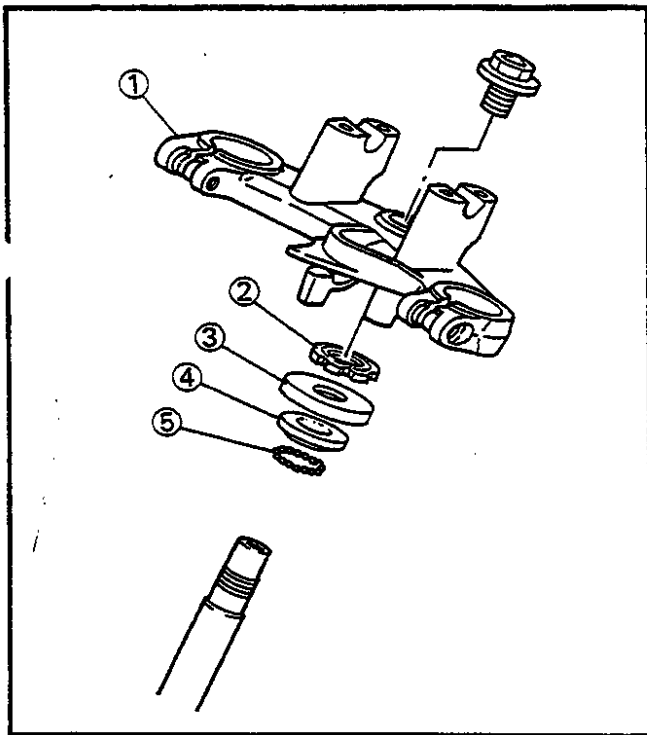

17. Remove:
- Handlebar crown ①
 - Ring nut ②
 - Bearing race cover ③
 - Bearing race ④
 - Ball bearing ⑤

NOTE: _____
Remove the ring nut by the Ring Nut Wrench.

	Ring Nut Wrench: 90890-01403
--	---

WARNING: _____
Support the lower bracket so that it may not fall down.

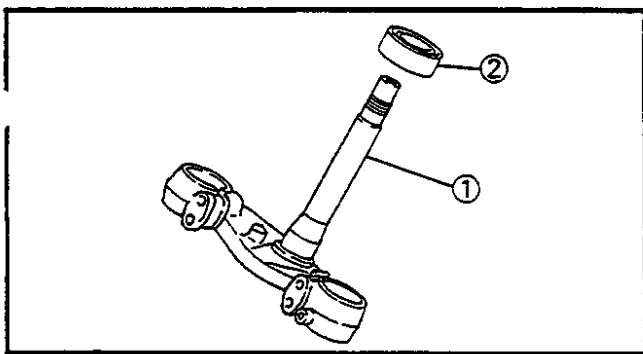

18. Remove:
- Lower bracket ①
 - Taper roller bearing ②

INSPECTION

1. Wash the bearings and races with a solvent.
2. Inspect:
 - Bearing ①
 - Bearing race
 Pitting/Damage → Replace.

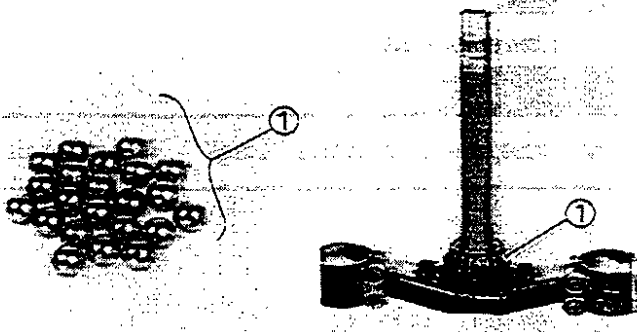

REMOVAL

Rear Shock Absorber

1. Remove:

- Seat
- Side covers

Refer to "SIDE COVERS" section in CHAPTER 3.

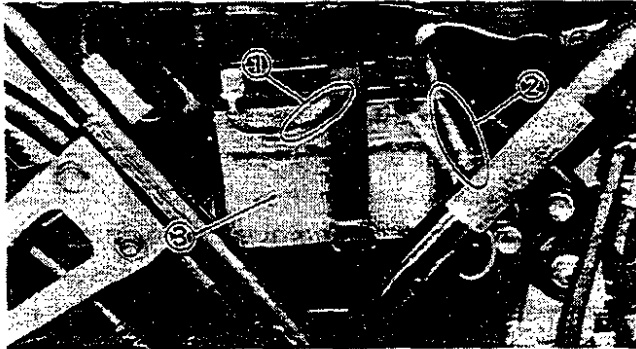

2. Disconnect:

- Battery negative lead ①
- Battery positive lead ②

CAUTION:

Disconnect the negative lead first, and then disconnect the positive lead.

3. Remove:

- Battery ③

4. Elevate the rear wheel by placing a suitable stand under the engine.

WARNING:

Securely support the motorcycle so there is no danger of it falling over.

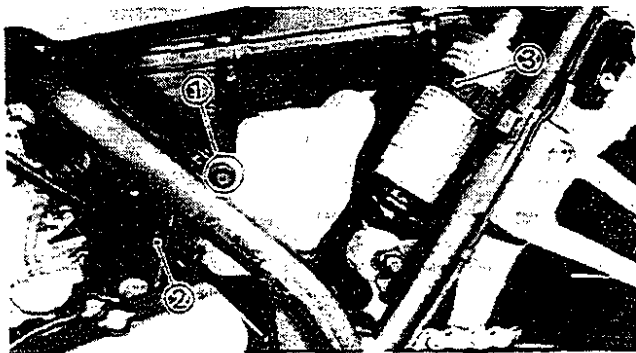

5. Remove:

- Bolt ① (Reservoir tank)

NOTE:

Do not disconnect the hose ②.

6. Unhook

- Band ③ (Sub tank)

7. Remove:

- Bolt ① (Relay arm—connecting arm)
- Bolt ② (Rear shock absorber)

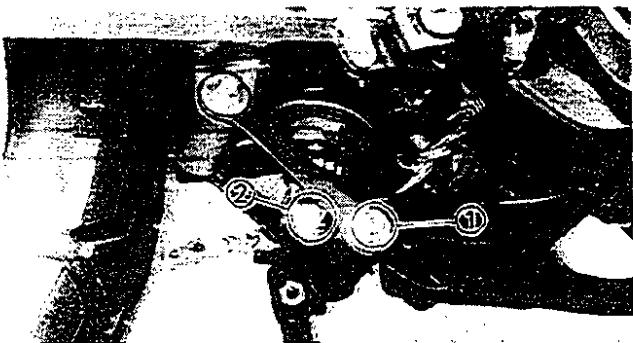

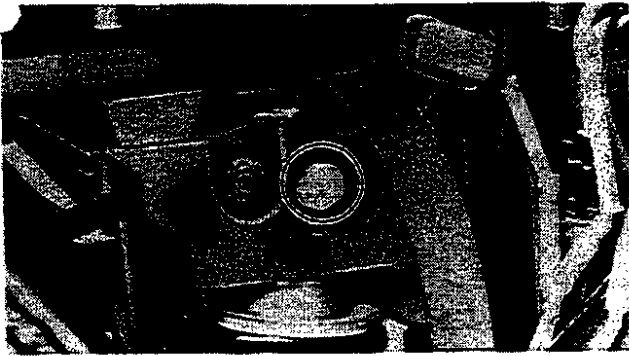

8. Remove:
 - Rear shock absorber

Swingarm

1. Elevate the rear wheel by placing a suitable stand under the engine.

WARNING: _____

Securely support the motorcycle so there is no danger of it falling over.

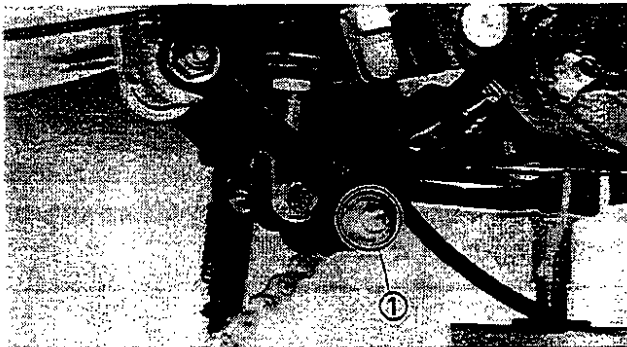

2. Remove:
 - Rear wheel
 Refer to "REAR WHEEL—REMOVAL" section in CHAPTER 7.

3. Remove:
 - Bolt ① (Relay arm—connecting arm)

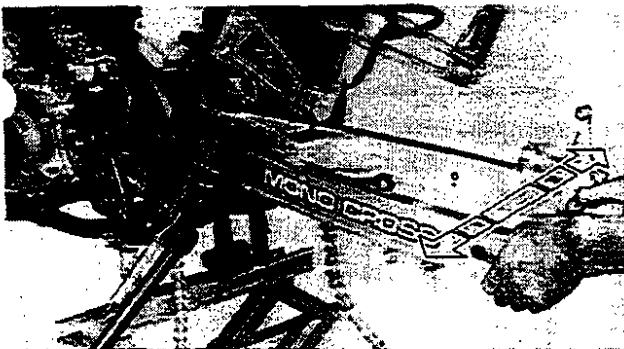

4. Check:
 - Swingarm (side play)
 Move swingarm from side to side.
 Over specified limit → Replace bearings

	Side Play (At End of Swingarm): 3.0 mm (0.12 in)
---	--

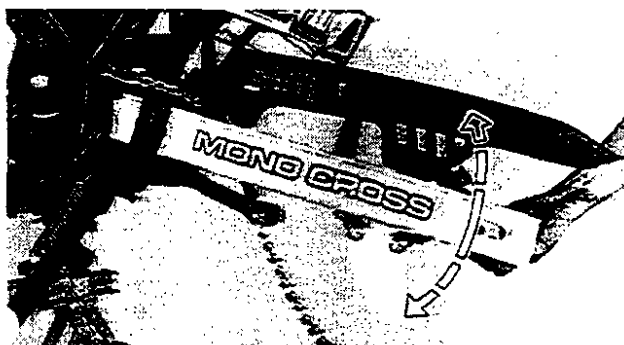

5. Check:
 - Swingarm (Vertical movement)
 Move swingarm up and down.
 Tightness/ Binding/ Rough Spots → Replace Bearings.

REAR SHOCK ABSORBER AND SWINGARM

CHAS 

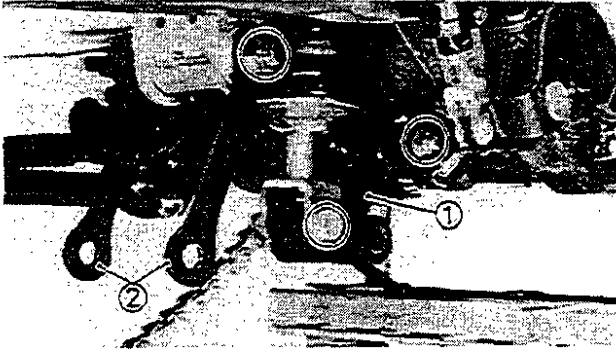

6. Remove:
- Relay arm ①
 - Connecting arm ②

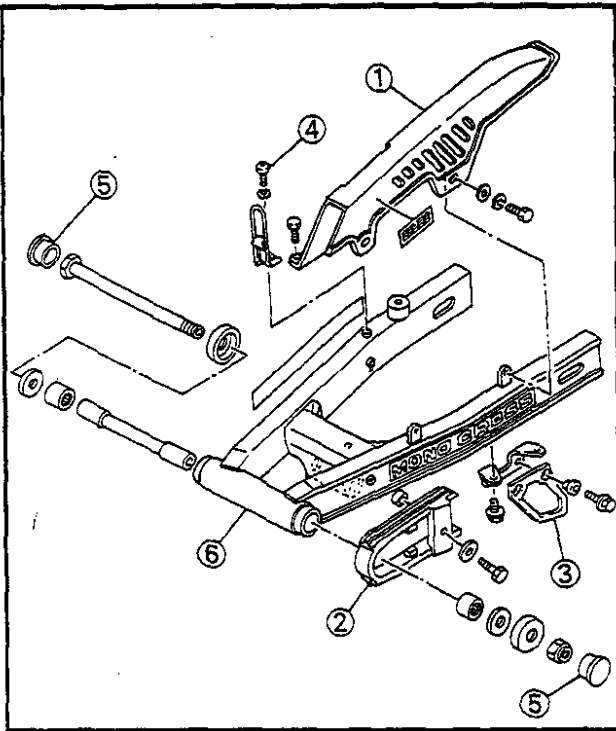

7. Remove:
- Chain case ①
 - Chain guard ②
 - Chain guide ③
 - Screw ④ (Brake hose clamp)
 - Blind plug ⑤
 - Swingarm ⑥

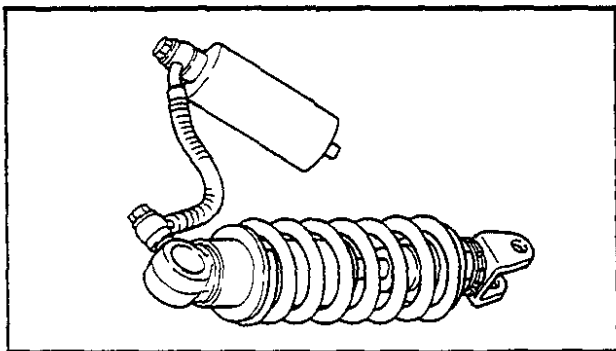

INSPECTION

1. Inspect:
- Shock absorber
Oil leaks/Damage → Replace.

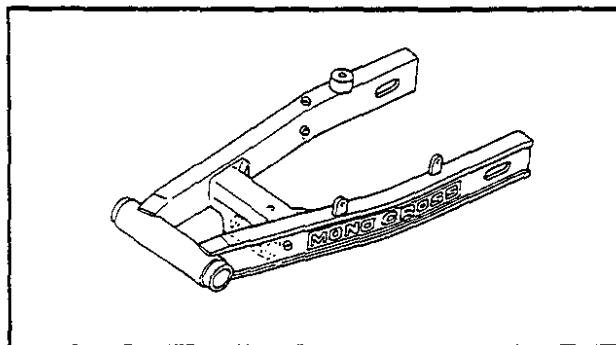

2. Inspect:
- Swingarm
Bends/Cracks/Damage → Replace.

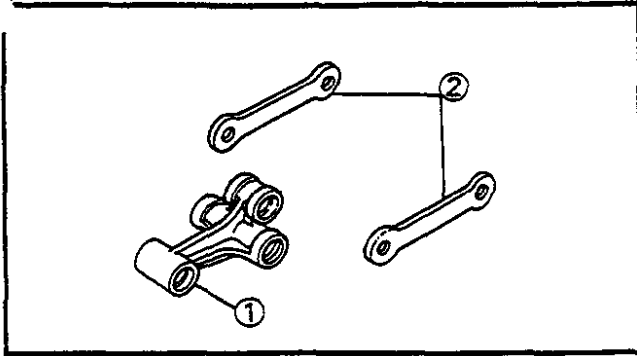

3. Inspect:

- Relay arm ①
- Connecting arm ②
- Bends/Cracks/Damage → Replace.

4. Inspect:

- Oil seals
- Damage → Replace.
- Thrust covers
- Damage → Replace.
- Bushes
- Scratches/Damage → Replace.
- Bearings
- Pitting/Damage → Replace.

NOTE:

When replacing the bearings of swingarm pivot, install new bearings ① as shown.

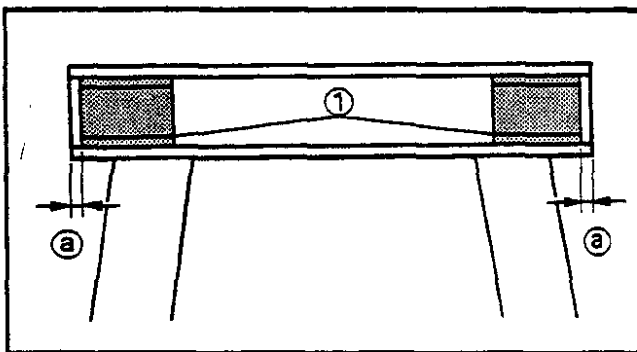

Ⓐ 0.5–1.0 mm (0.02–0.04 in)

INSTALLATION

Swingarm

Reverse the "REMOVAL" procedure.
Note the following points.

1. Apply:

- Lithium soap base grease
- To oil seals, bearings, bushes and inside of thrust covers.

2. Install:

- Swing arm



Pivot Shaft:

100 Nm (10.0 m•kg, 72 ft•lb)



3. Install:

- Relay arm
- Connecting arm



Nut (Connecting Arm— Swingarm):

50 Nm (5.0 m•kg, 36 ft•lb)

Nut (Relay Arm—Frame):

40 Nm (4.0 m•kg, 29 ft•lb)

Nut (Relay Arm—Connecting Arm):

50 Nm (5.0 m•kg, 36 ft•lb)

Nut (Relay Arm—Rear Shock Absorber):

40 Nm (4.0 m•kg, 29 ft•lb)

4. Install:

- Rear wheel

Refer to "REAR WHEEL—INSTALLATION"
section in CHAPTER 7.



Axle Nut:

100 Nm (10.0 m•kg, 72 ft•lb)

Locknut (Wheel Axle):

45 Nm (4.5 m•kg, 32 ft•lb)

Bolts (Brake Caliper):

35 Nm (3.5 m•kg, 25 ft•lb)

Bolt (Brake Caliper Bracket):

45 Nm (4.5 m•kg, 32 ft•lb)

5. Adjust:

- Drive chain slack

Refer to "DRIVE CHAIN SLACK ADJUST-
MENT" section in CHAPTER 3.



Drive Chain Slack:

20 ~ 30 mm (0.8 ~ 1.2 in)

Rear Shock Absorber

Reverse the "REMOVAL" procedure.

Note the following points.

1. Apply:

- Lithium soap base grease
To oil seals and collar.



2. Install:

- Rear shock absorber



Nut (Upper):

40 Nm (4.0 m•kg, 29 ft•lb)

Nut (Lower):

40 Nm (4.0 m•kg, 29 ft•lb)

Nut (Relay Arm—Connecting Arm):

50 Nm (5.0 m•kg, 36 ft•lb)

3. Connect:

- Battery positive lead
- Battery negative lead

CAUTION:

Connect the positive lead first, and then connect the negative lead.

4. Install:

- Side covers
- Seat

Refer to "SIDE COVERS" section in CHAPTER 3.

DRIVE CHAIN AND SPROCKETS**NOTE:**

Before removing the drive chain and sprockets, drive chain slack and 10-link length of drive chain should be measured.

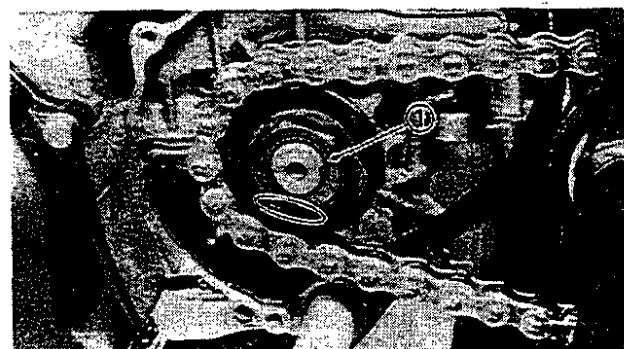
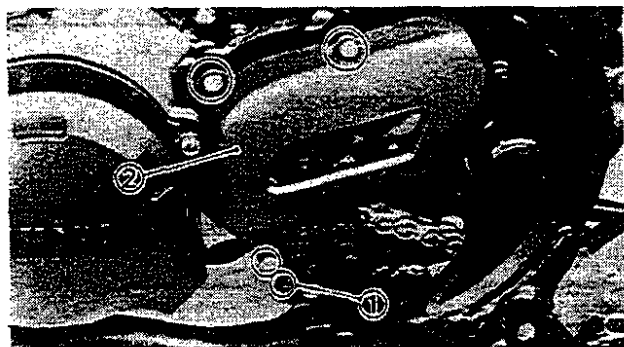
**REMOVAL**

1. Remove:
 - Bolt ① (Shift arm)
 - Crankcase cover ② (Left-hand)

2. Straighten:
 - Lock washer tab

3. Remove:
 - Drive sprocket ①

4. Elevate the rear wheel by placing a suitable stand under the engine.

WARNING:

Support the motorcycle securely so there is no danger of it falling over.

5. Remove:
 - Rear WheelRefer to "REAR WHEEL—REMOVAL" section in CHAPTER 7.

6. Remove:
 - Swingarm
 - Drive chainRefer to "REAR SHOCK ABSORBER AND SWINGARM—REMOVAL" section in CHAPTER 7.

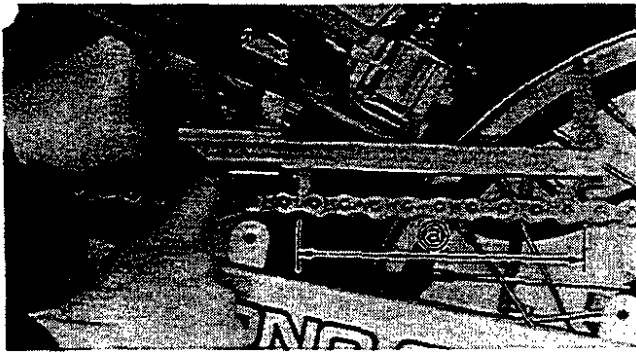

INSPECTION

1. Measure:

- 10-link length (a) (Drive chain)
Out of specification → Replace drive chain.



10-Link Length Limit:
150.1 mm (5.91 in)

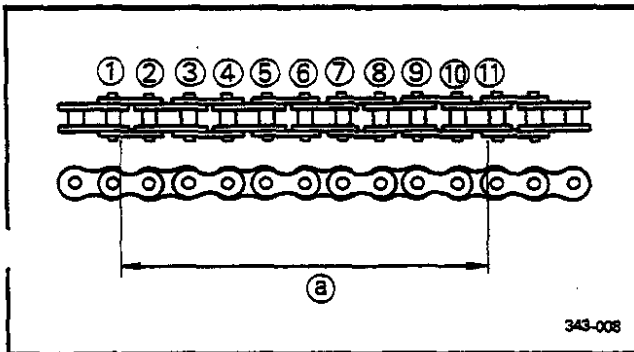

NOTE:

- For measurement make the chain tense by finger.
- 10-link length is a measurement between the insides of the ① and ⑪ rollers as shown.
- Two or three different 10-link lengths should be measured.

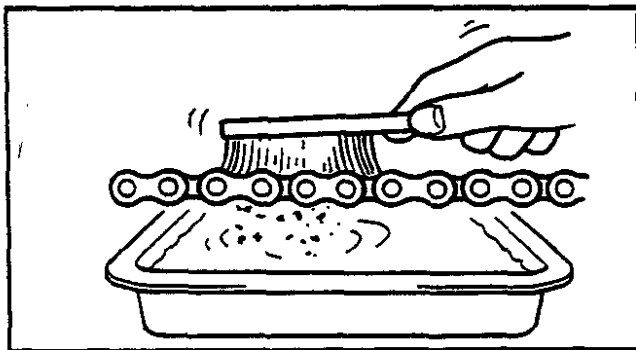

2. Clean:

- Drive chain
Place it in kerosene, and brush off as much dirt as possible. Then, dry the chain.

CAUTION:

- The solvents can damage the O-rings. Use only kerosene to clean the chain.
- Do not use wire brush to clean the chain.

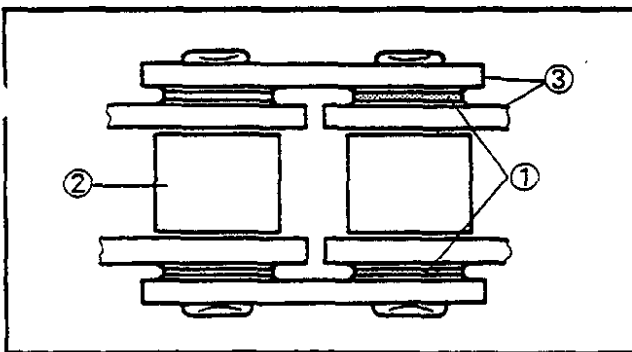

3. Inspect:

- O-rings ① (Drive Chain)
Damage → Replace drive chain.
- Rollers ② and side plates ③
Damage/Wear → Replace drive chain.

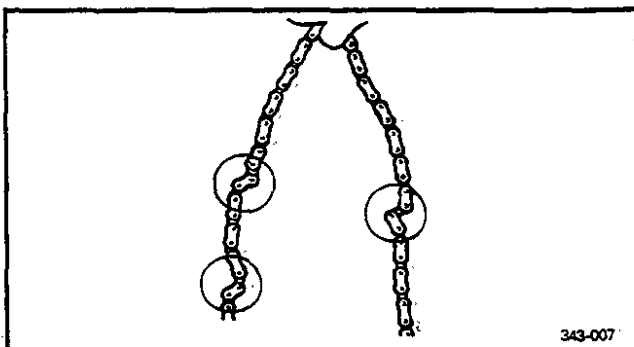

4. Inspect:

- Drive chain
Stiff → Lubricate or replace.

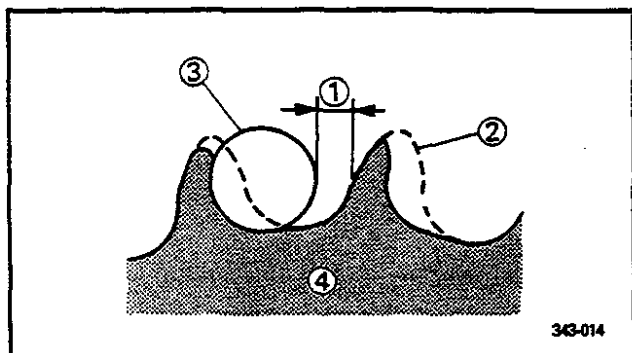

5. Inspect:
- Drive and driven sprockets
- Wear/Damage → Replace.

- ① 1/4 tooth
- ② Correct
- ③ Roller
- ④ Sprocket

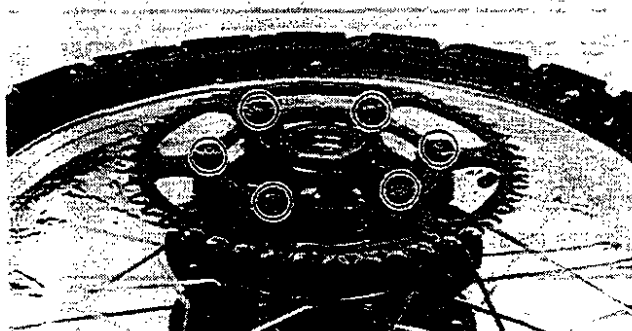

- Driven sprocket replacement steps:**
- Straighten the lock washer tabs and remove the driven sprocket.
 - Install a new driven sprocket and lock washers.

WARNING:

Always use new lock washers.



Nuts (Driven Sprocket):
37 Nm (3.7 m•kg, 27 ft•lb)

- Bend the lock washer tabs along the nut flats.

INSTALLATION

Reverse the "REMOVAL" procedure.
Note the following points.

1. Install:
- Swingarm
 - Drive chain
- Refer to "REAR SHOCK ABSORBER AND SWINGARM—INSTALLATION" section in CHAPTER 7.



Nut (Pivot Shaft):
100 Nm (10.0 m•kg, 72 ft•lb)

Nut (Swingarm—Connecting Arm):
50 Nm (5.0 m•kg, 36 ft•lb)



2. Install:

- Drive sprocket



Nut (Drive Sprocket):
90 Nm (9.0 m•kg, 65 ft•lb)

WARNING:

Always use a new lock washer.

NOTE:

After tightening the nut, bend the lock washer tab along the nut flats.

3. Install:

- Rear wheel

Refer to "REAR WHEEL—INSTALLATION" section in CHAPTER 7.



Axle Nut:
100 Nm (10.0 m•kg, 72 ft•lb)
Locknut (Wheel Axle):
45 Nm (4.5 m•kg, 32 ft•lb)
Bolts (Brake Caliper):
35 Nm (3.5 m•kg, 25 ft•lb)
Bolt (Brake Caliper Bracket):
45 Nm (4.5 m•kg, 32 ft•lb)

4. Adjust:

- Drive chain slack

Refer to "DRIVE CHAIN SLACK ADJUSTMENT" section in CHAPTER 3.



Drive Chain Slack:
20 ~ 30 mm (0.8 ~ 1.2 in)

5. Install:

- Crankcase cover (Left-hand)
- Shift arm



Bolts (Crankcase Cover):
5 Nm (0.5 m•kg, 3.6 ft•lb)
Bolt (Shift Arm):
14 Nm (1.4 m•kg, 10 ft•lb)

ELECTRICAL

TDR CIRCUIT DIAGRAM

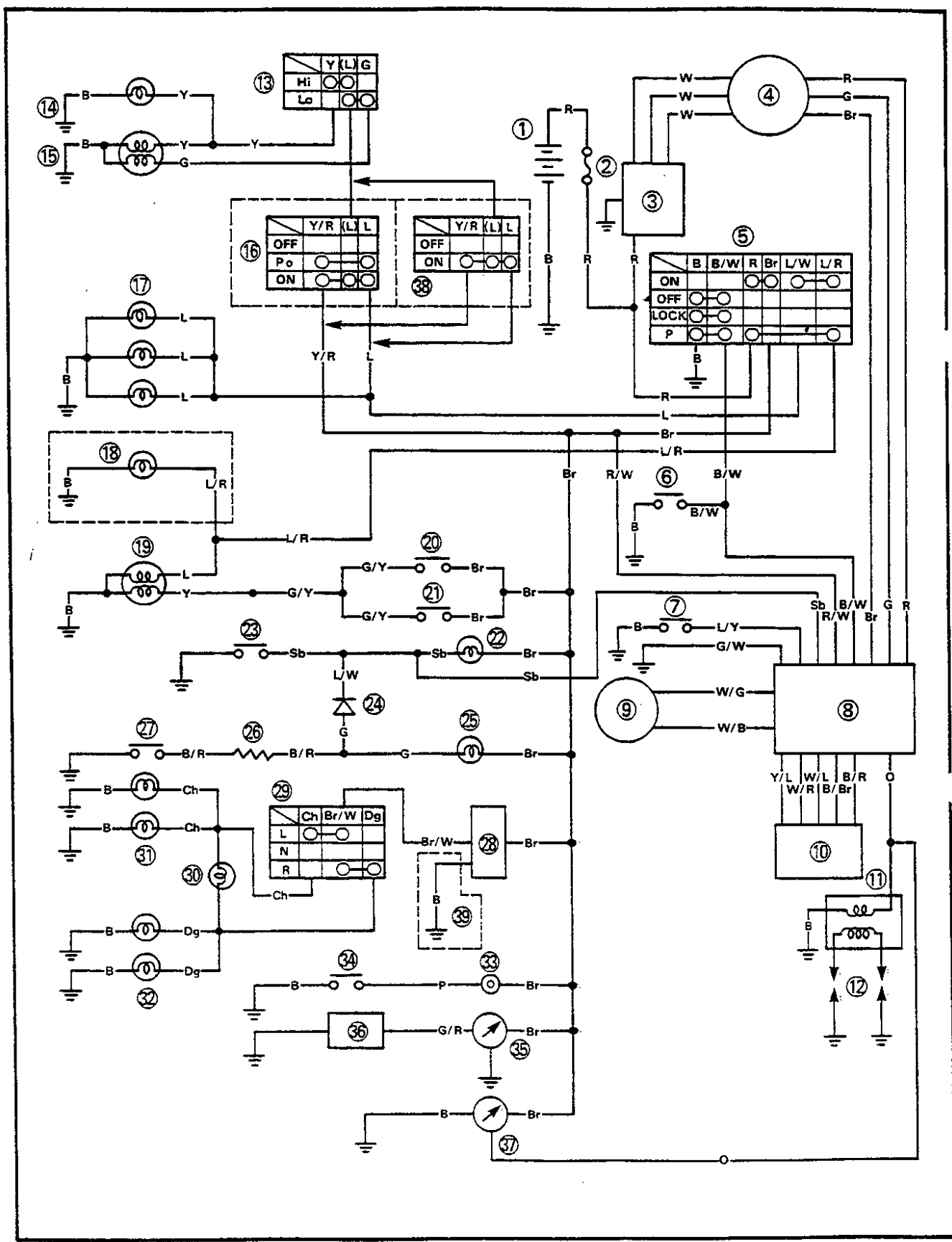

TDR CIRCUIT DIAGRAM



- | | |
|---|----------------------------------|
| ① Battery | ②① Rear brake switch |
| ② Circuit breaker | ②② "NEUTRAL" indicator light |
| ③ Rectifier/Regulator | ②③ Neutral switch |
| ④ CDI magneto (Source coil/Stator coil) | ②④ Diode |
| ⑤ Main switch | ②⑤ "OIL" indicator light |
| ⑥ "ENGINE STOP" switch | ②⑥ Resistor |
| ⑦ Sidestand switch | ②⑦ Oil level gauge |
| ⑧ CDI unit/YPVS control unit | ②⑧ Flasher relay |
| ⑨ CDI magneto (Pickup coil) | ②⑨ "TURN" switch |
| ⑩ Servomotor | ③⑩ "TURN" indicator light |
| ⑪ Ignition coil | ③① Flasher light (Left) |
| ⑫ Spark plug | ③② Flasher light (Right) |
| ⑬ "LIGHTS" (Dimmer) switch | ③③ Horn |
| ⑭ "HIGH BEAM" indicator light | ③④ "HORN" switch |
| ⑮ Headlight | ③⑤ Temperature gauge |
| ⑯ "LIGHTS" switch (Except for England) | ③⑥ Thermo unit |
| ⑰ Meter light | ③⑦ Tachometer |
| ⑱ Auxiliary light (Except for England) | ③⑧ "LIGHTS" switch (For England) |
| ⑲ Tail/Brake light | ③⑨ For Germany |
| ⑳ Front brake switch | |

COLOR CODE

B	Black	Sb	Sky blue	W/B	White/Black
R	Red	Br	Brown	W/G	White/Green
O	Orange	L/B	Blue/Black	Y/L	Yellow/Blue
L	Blue	L/W	Blue/White	Y/R	Yellow/Red
P	Pink	L/Y	Blue/Yellow	Y/B	Yellow/Black
Y	Yellow	L/R	Blue/Red	G/R	Green/Red
G	Green	B/Y	Black/Yellow	G/Y	Green/Yellow
W	White	B/W	Black/White	Br/W	Brown/White
Ch	Chocolate	B/R	Black/Red	R/Y	Red/Yellow
Dg	Dark green	B/L	Black/Blue		
Gy	Gray	W/R	White/Red		



ELECTRICAL COMPONENTS

- ① Servomotor
- ② Flasher relay
- ③ Thermo unit
- ④ Oil level gauge
- ⑤ Sidestand switch
- ⑥ Neutral switch
- ⑦ Horn
- ⑧ Main switch

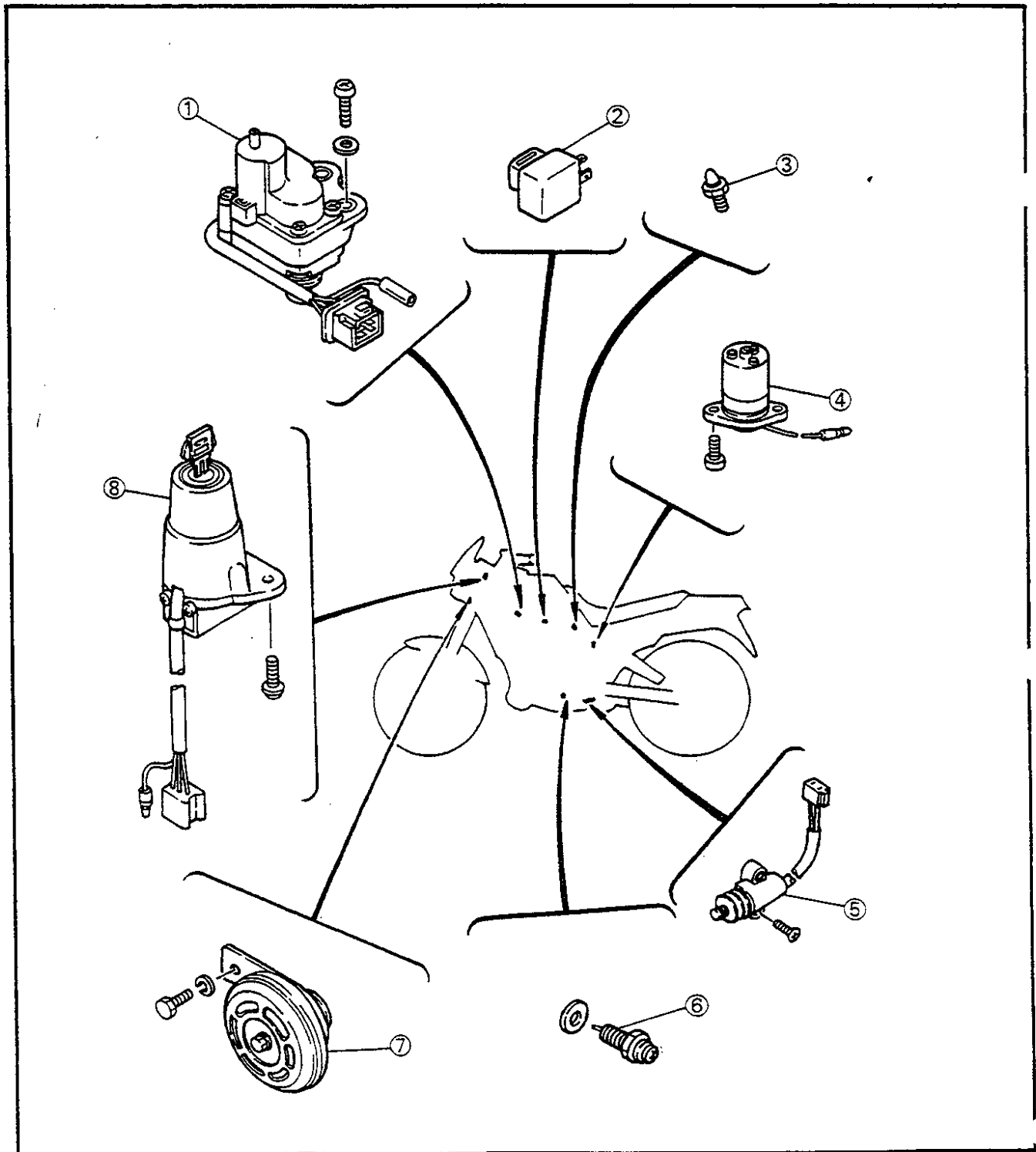

ELECTRICAL COMPONENTS

ELEC



- ① Wireharness
- ② Battery
- ③ Rear brake switch
- ④ Circuit breaker
- ⑤ Ignition coil
- ⑥ CDI unit/YPVS control unit
- ⑦ Rectifier/Regulator
- ⑧ Diode unit

BATTERY:

CAPACITY: 12V 4AH

SPECIFIC GRAVITY: 1.280

IGNITION COIL:

PRIMARY COIL RESISTANCE:

0.28 ~ 0.38Ω at 20°C (68°F)

SECONDARY COIL RESISTANCE:

4.7 ~ 7.0kΩ at 20°C (68°F)

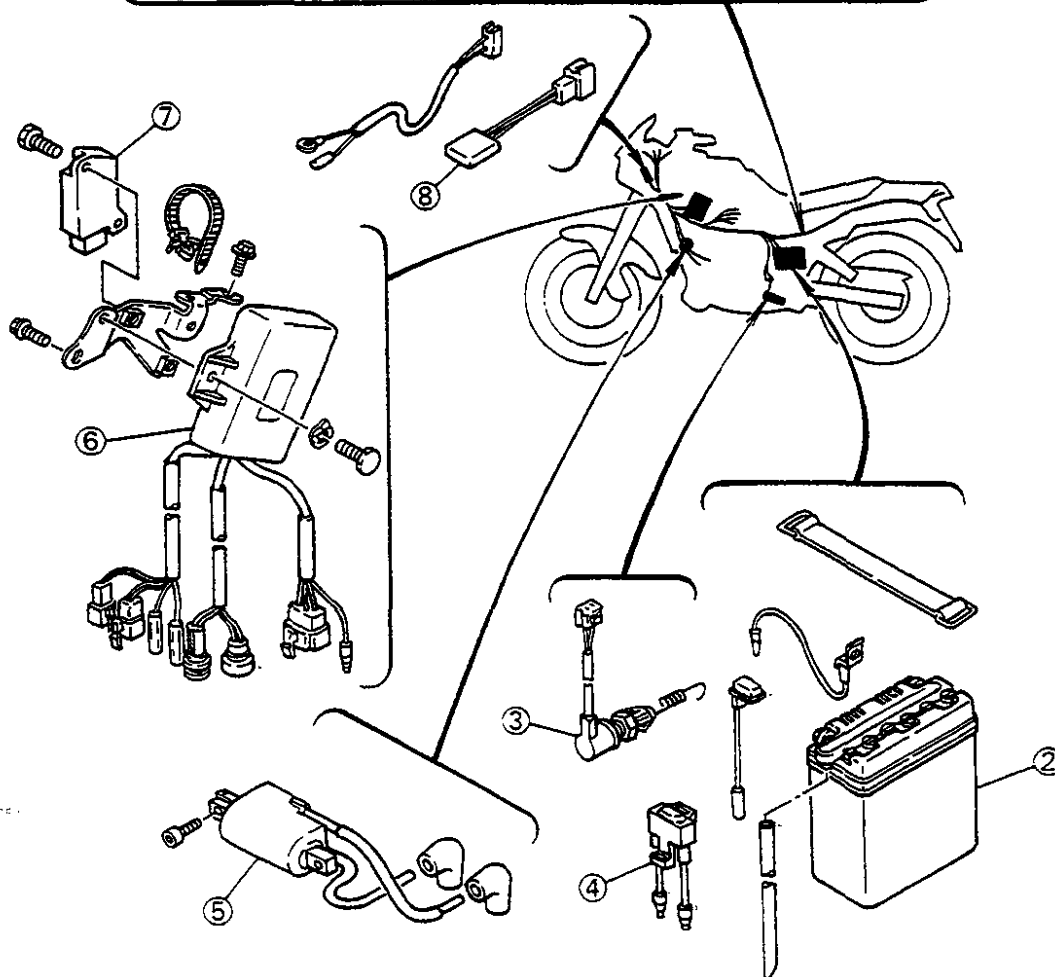
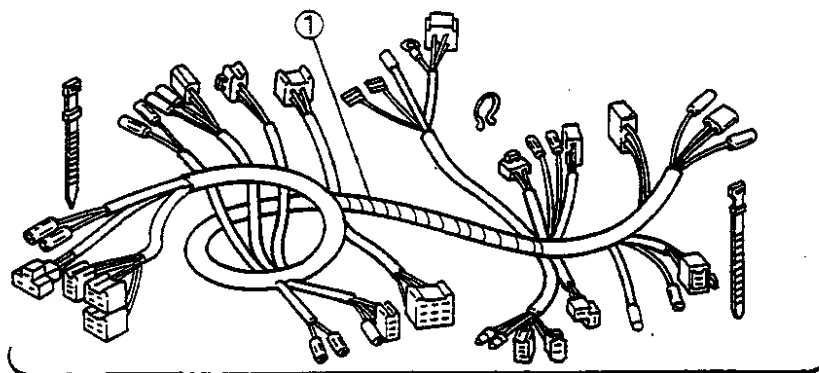

CHECKING OF SWITCHES

Check the switches for the continuity between the terminals to determine correct connection.

Read the following for switch inspection.

SWITCH CONNECTION AS SHOWN IN MANUAL

The manual contains a connection chart as shown left showing the terminal connections of the switches (e.g., main switch, handlebar switch, brake switch, lighting switch, etc.)

The extreme left column indicates the switch positions and the top line indicates the colors of leads connected with the terminals in the switch component.

“○—○” indicates the terminals between which there is a continuity of electricity; i.e., a closed circuit at the respective switch positions.

In this chart:

“R and Br” and “L/W and L/R” are continuous with the “ON” switch position.

“B and B/W” is continuous with the “OFF” switch position.

“B and B/W” is continuous with the “LOCK” switch position.

“B and B/W” and “R and L/R” are continuous with the “P” switch position.

	B	B/W	R	Br	L/W	L/R
ON			○—○		○—○	
OFF	○—○					
LOCK	○—○					
P	○—○		○—○			○—○

CHECKING SWITCH FOR TERMINAL CONNECTION

Before checking the switch, refer to the connection chart as shown above and check for the correct terminal connection (closed circuit) by the color combination.

To explain how to check the switch, the main switch is taken for example in the following.

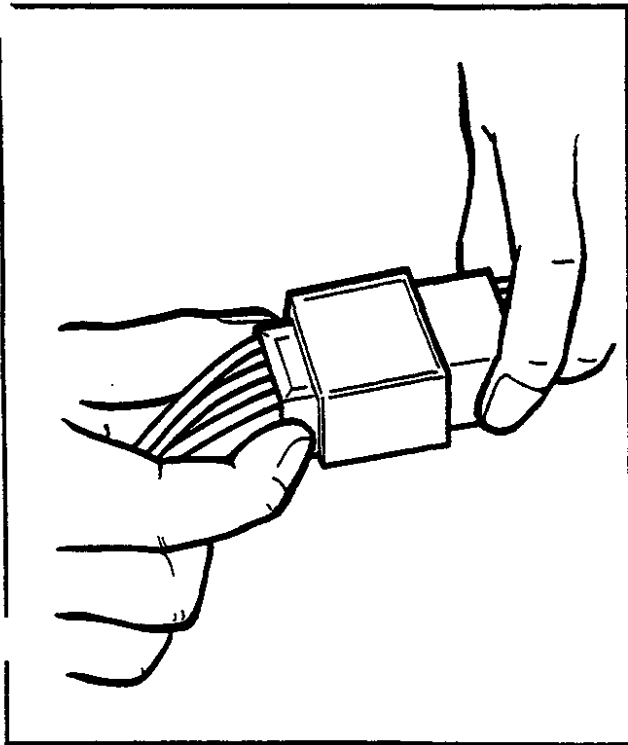

1. Disconnect the main switch coupler from the wireharness.

CAUTION:

Never disconnect the main switch coupler by pulling the leads. Otherwise, leads may be pulled off the terminals inside the coupler.

2. Inspect whether any lead is off the terminal inside the coupler. If it is, repair it.

NOTE:

If the coupler is clogged with mud or dust, blow it off by compressed air.

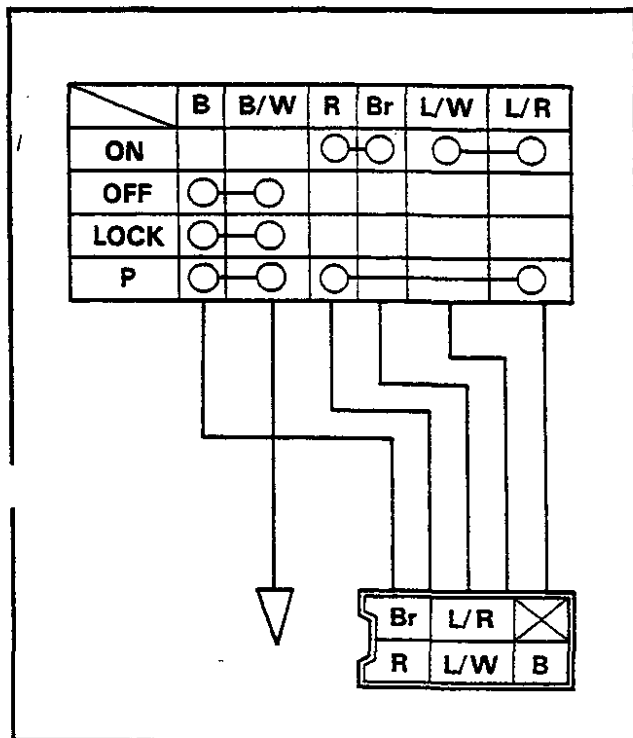

3. Use the connection chart to check the color combination for continuity (a closed circuit). In this example, the continuity is as follows.

“R and Br” and “L/W and L/R” are continuous with the “ON” switch position.

“B and B/W” is continuous with the “OFF” switch position.

“B and B/W” is continuous with the “LOCK” switch position.

“B and B/W” and “R and L/R” are continuous with the “P” switch position.

Please note that there is no continuity (an open circuit) at all for the color combinations other than the above.

4. Check the switch component for the continuity between “R and Br”.

Checking steps:

- Turn the switch key to the “ON”, “OFF”, “LOCK”, and “P” several times.
- Set the pocket tester selector to the “ $\Omega \times 1$ ”.
- Connect the tester (+) lead to the “R” lead terminal in the coupler and the (-) lead to the “Br” lead terminal.

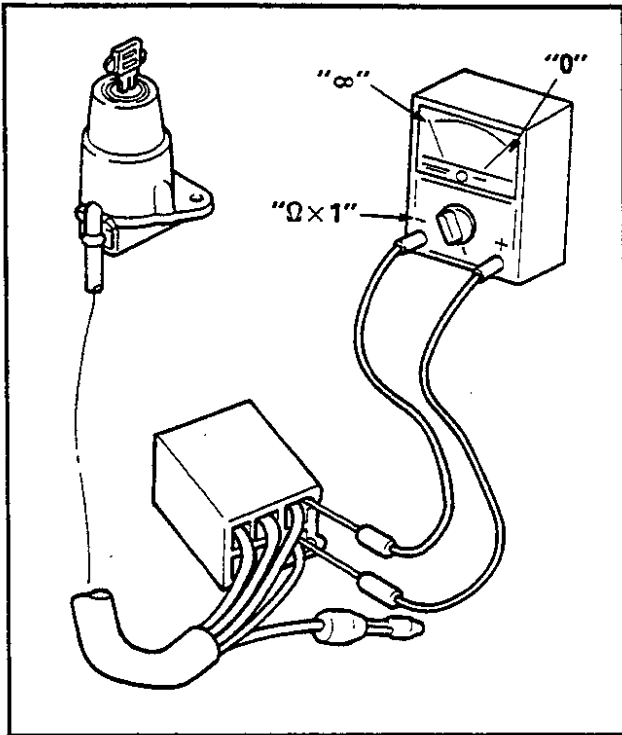

NOTE:

Use thin probes for checking the continuity. Otherwise, the probes may contact other terminals inside the coupler.

- Check the continuity between "R" and "Br" at the respective switch positions of "ON" ①, "OFF" ②, "LOCK" ③, and "P" ④. There must be continuity (the tester indicating "0") at the "ON" switch position, and there must be no continuity (the tester indicating "∞") at "OFF", "LOCK", or "P". There is something wrong between "R" and "Br" if there is no continuity at the "ON" position or if there is some continuity either at the "OFF" or "LOCK" or "P".

NOTE:

Check the switch for continuity several times.

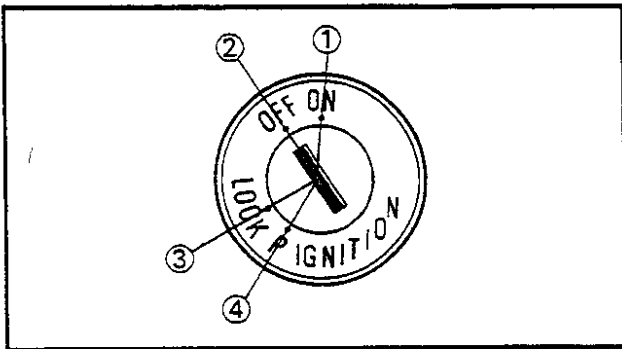

5. Next go on to checking of the continuity between "B and B/W", "L/W and L/R", and "R and L/R" at the respective switch positions, as in the same manner mentioned above.

6. If there is something wrong with any one of the combinations, replace the switch component.



CHECKING OF BULBS (FOR HEADLIGHT, TAIL/BRAKE LIGHT, FLASHER LIGHT, METER LIGHT, ETC.)

Check the bulb terminal continuity for the condition of the bulb.

KINDS OF BULBS

The bulbs used in the motorcycle are classified as shown left by the shape of the bulb socket.

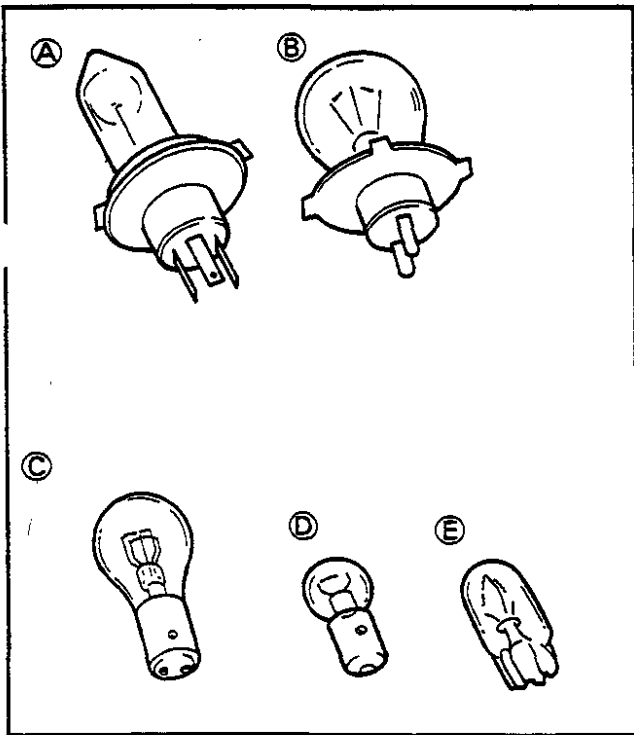

Ⓐ and Ⓑ are mainly used for the headlight.

Ⓒ is mainly used for the flasher light and tail/brake light.

Ⓓ and Ⓔ are mainly used for the meter light and other indicator lights.

CHECKING BULB CONDITION

1. Remove the bulb.

NOTE:

- Bulbs of the Ⓐ and Ⓑ type uses a bulb holder. Remove the bulb holder before removing the bulb itself. Most of the bulb holders for this type can be removed by turning them counter-clockwise.
- Most of the bulbs of Ⓒ and Ⓓ type can be removed from the bulb sockets by pushing and turning them counterclockwise.
- Bulbs of the Ⓔ type can be removed from the bulb sockets by simply pulling them out.

CAUTION:

Be sure to hold the socket firmly when removing the bulb. Never pull the lead. Otherwise, the lead may be pulled off the terminal in the coupler.

WARNING:

Keep flammable products or your hands away from the headlight bulb while it is on. It will be hot. Do not touch the bulb until it cools down.



2. Check the bulb terminals for continuity.

Checking steps:

- Set the pocket tester selector to the " $\Omega \times 1$ ".
- Connect the tester leads to the respective bulb terminals. Take for example a 3-terminal bulb as shown left. First check the continuity between the ① and ② terminals by connecting the tester (+) lead to the ① terminal and the tester (-) lead to the ② terminal. Then check the continuity between the ① and ③ terminals by connecting the tester (+) lead still to the ① terminal and the tester (-) lead to the ③ terminal. If the tester shows " ∞ " in either case, replace the bulb.

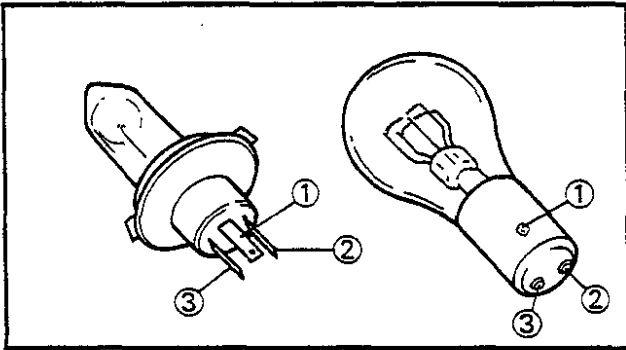

3. Check the bulb socket by installing a proven bulb to it. As in the checking of bulbs, connect the pocket tester leads to the respective leads of the socket and check for continuity in the same manner as mentioned above.



IGNITION AND STARTING SYSTEM CIRCUIT DIAGRAM

Below circuit diagram shows ignition and starting circuit.

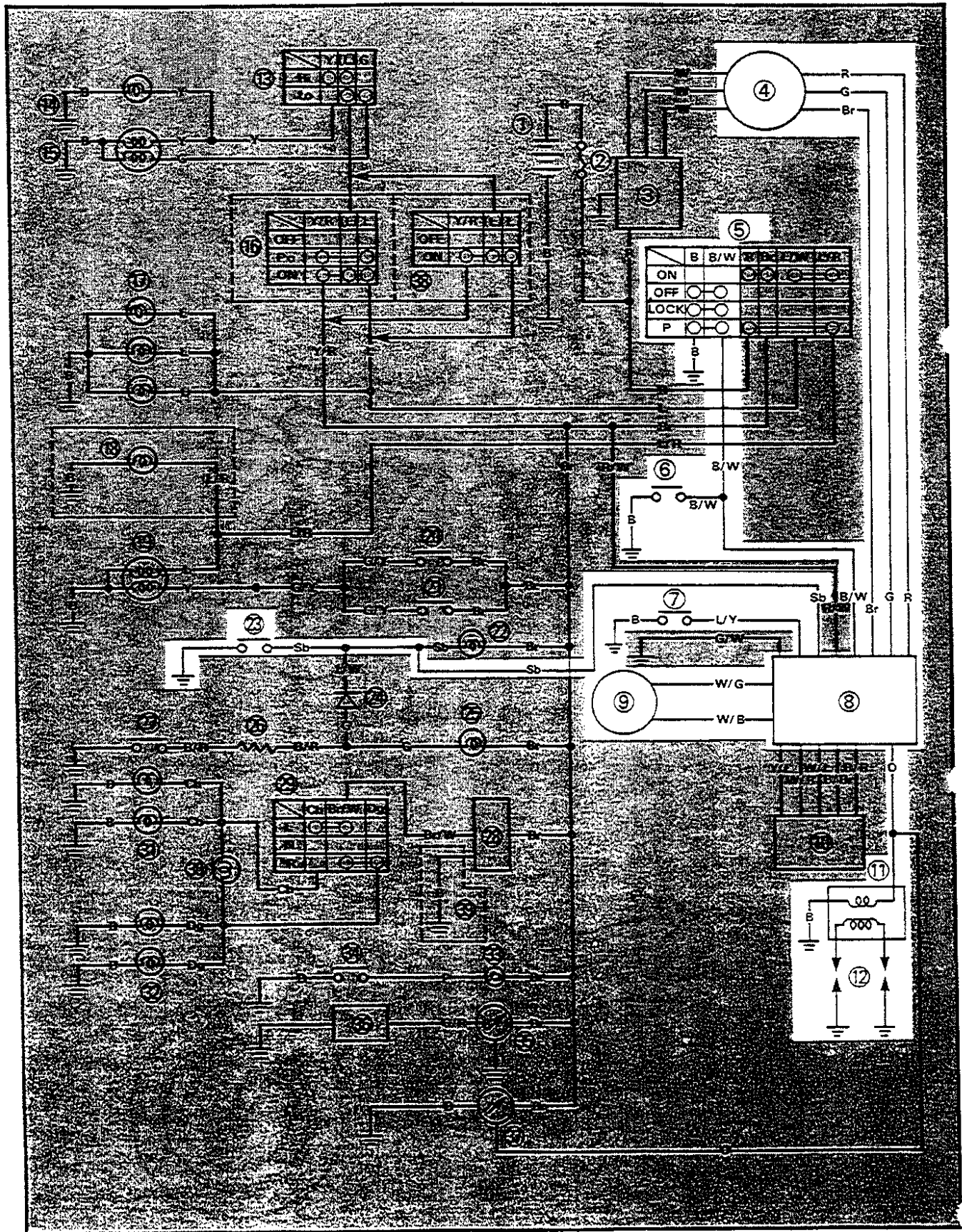

IGNITION AND STARTING SYSTEM

ELEC



NOTE: _____

For the color codes, see page 8-2.

- ④ CDI magneto (Source coil/Stator coil)
- ⑤ Main switch
- ⑥ "ENGINE STOP" switch
- ⑦ Sidestand switch
- ⑧ CDI unit/Ignition control unit
- ⑨ CDI magneto (Pickup coil)
- ⑪ Ignition coil
- ⑫ Spark plug
- ⑬ Neutral switch

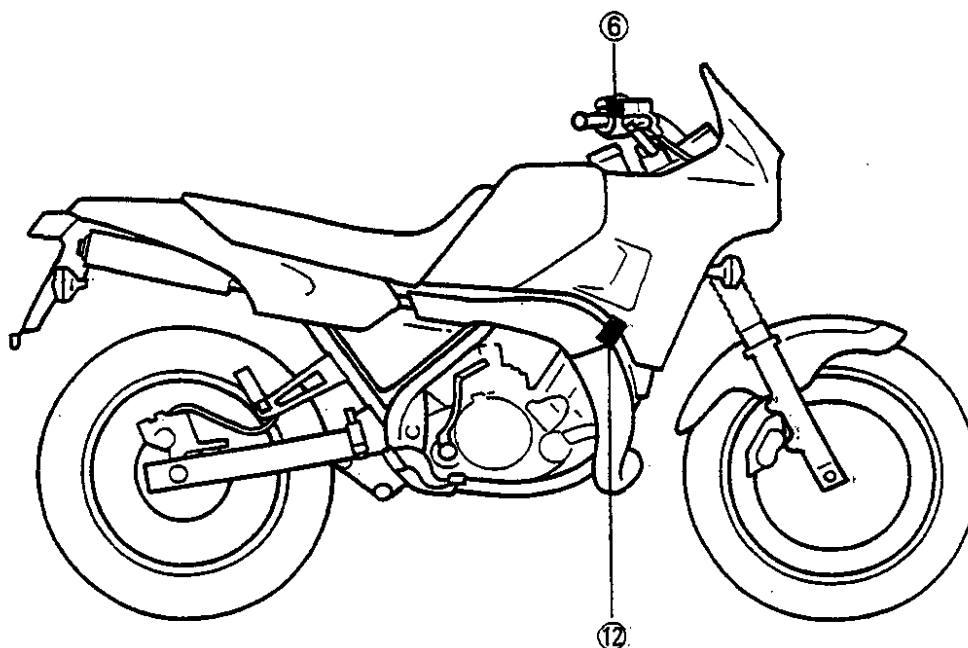
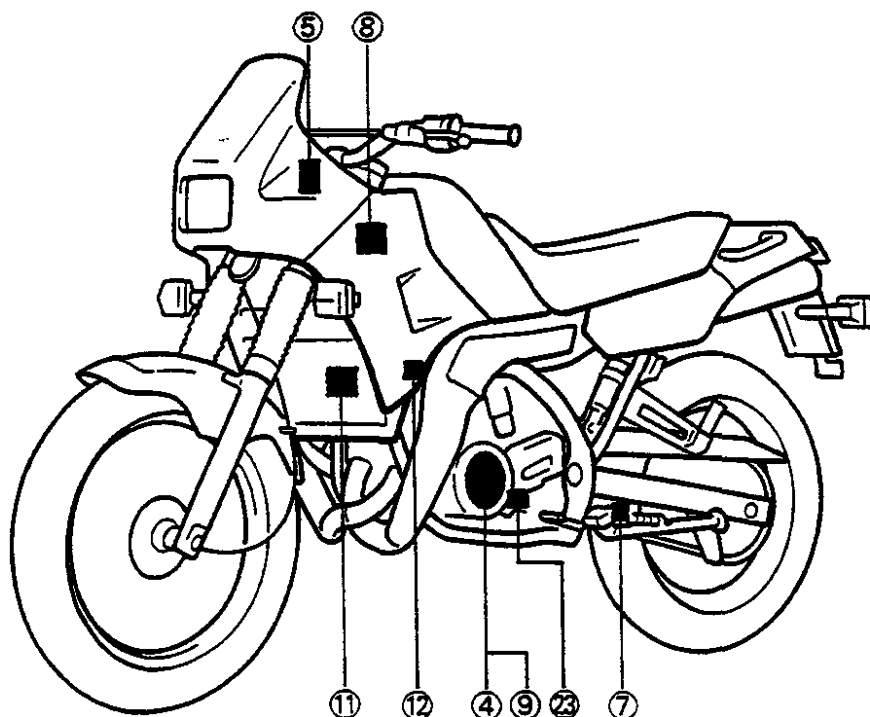



TROUBLESHOOTING

IF IGNITION SYSTEM SHOULD BECOME INOPERATIVE (NO SPARK OR INTERMITTENT SPARK).

Procedure

Check;

- | | |
|------------------------------|----------------------------|
| 1. Spark plug | 7. Sidestand switch |
| 2. Ignition spark gap | 8. Neutral switch |
| 3. Spark plug cap resistance | 9. Pickup coil resistance |
| 4. Ignition coil resistance | 10. Source coil resistance |
| 5. "ENGINE STOP" switch | 11. Wiring connection. |
| 6. Main switch | (Entire ignition system) |

NOTE:

• Remove the following parts before troubleshooting.

- | | |
|--------------------------|-----------------------|
| 1) Seat | 5) Fuel tank |
| 2) Upper cowling | 6) Side cover (Right) |
| 3) Lower cowling (Left) | 7) Side cover (Left) |
| 4) Lower cowling (Right) | |

• Use the following special tools in this troubleshooting.



Dynamic Spark Tester:
P/N. 90890-03144



Pocket Tester:
P/N. 90890-03112

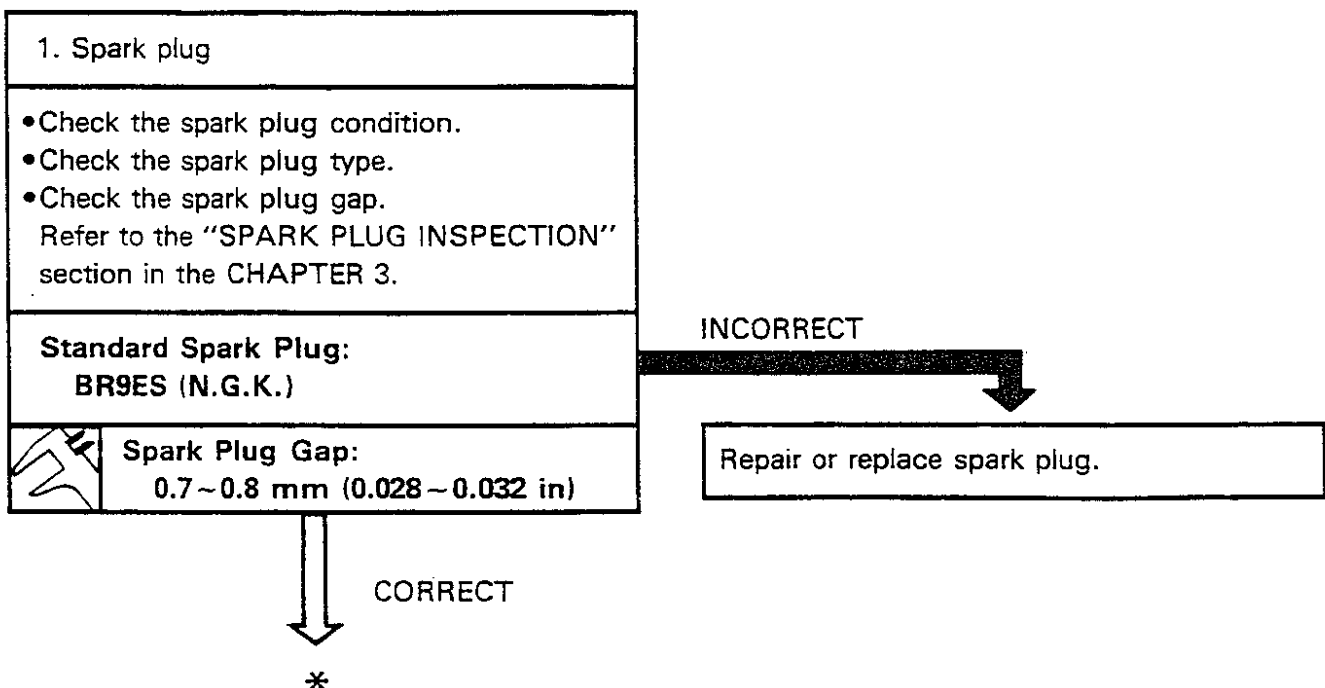



*
↓
CORRECT

2. Ignition spark gap

- Disconnect the spark plug cap from spark plug.
- Connect the Dynamic Spark Tester ① as shown.
- ② Spark plug cap
- ③ Spark plug
- Turn the main switch to "ON".
- Kick the kick crank.

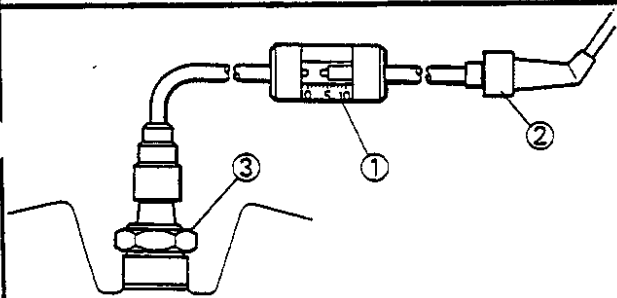

- Check the ignition spark gap.
- Start engine, and increase spark gap until mis-fire occurs.



Minimum Spark Gap:
6.0 mm (0.24 in)

MEETS SPECIFICATION

Ignition system is good.

↓
OUT OF SPECIFICATION
OR NO SPARK

3. Spark plug cap resistance

- Remove the spark plug cap.
- Connect the pocket Tester ($\Omega \times 1k$) to the spark plug cap.

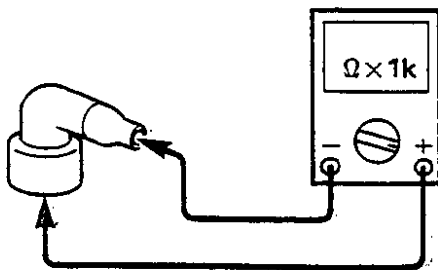

- Check the spark plug cap for specified resistance.



Spark Plug Cap Resistance:
4–6k Ω at 20°C (68°F)

OUT OF SPECIFICATION

Spark plug cap is faulty, replace it.

↓
*
MEETS
SPECIFICATION



4. Ignition coil resistance

- Disconnect the ignition coil leads (Orange and Black) from the wireharness.
- Connect the Pocket Tester ($\Omega \times 1$) to the ignition coil.

Tester (+) Lead \rightarrow \oplus Terminal
 Tester (-) Lead \rightarrow \ominus Terminal

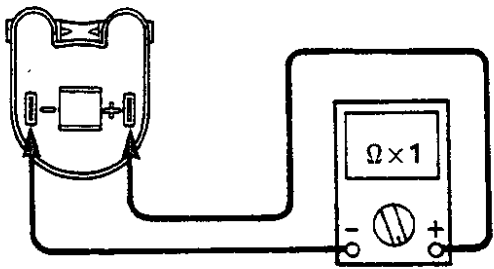

- Check the primary coil for specified resistance.



Primary Coil Resistance:
 $0.28 - 0.38 \Omega$ at 20°C (68°F)
 (\oplus Terminal $-\ominus$ Terminal)

- Connect the Pocket Tester ($\Omega \times 1\text{k}$) to the ignition coil.

Tester (+) Lead \rightarrow Spark Plug Lead ①
 Tester (-) Lead \rightarrow Spark Plug Lead ②

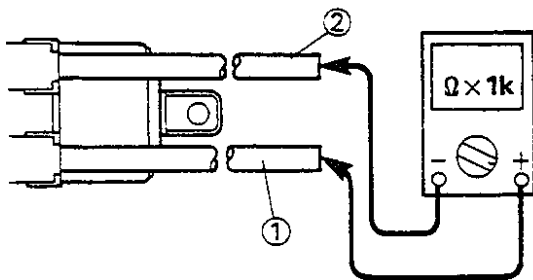

- Check the secondary coil for specified resistance.



Secondary Coil Resistance:
 $4.7 - 7.0\text{k}\Omega$ at 20°C (68°F)
 (Spark Plug Lead $-\text{Spark Plug Lead}$)

OUT OF SPECIFICATION

Ignition coil is faulty, replace it.

* BOTH MEET SPECIFICATIONS



5. "ENGINE STOP" switch

- Disconnect the "ENGINE STOP" switch leads from the wireharness.
- Check the switch component for the continuity between "Black/White ① and Black ②". Refer to the "CHECKING OF SWITCHES" section.

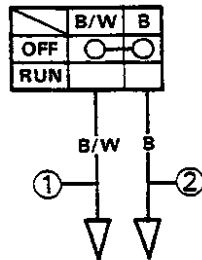
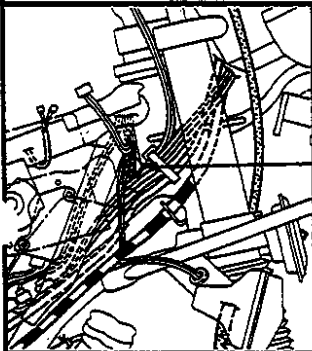

INCORRECT

"ENGINE STOP" switch is faulty, replace handlebar switch (Right).

↓
CORRECT

6. Main switch

- Disconnect the main switch coupler and lead from the wireharness.
- Check the switch component for the continuity between "Black/White ① and Black ②". Refer to the "CHECKING OF SWITCHES" section.

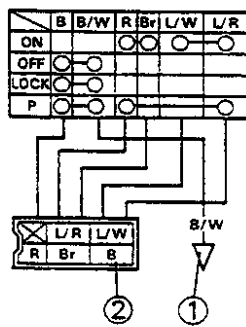
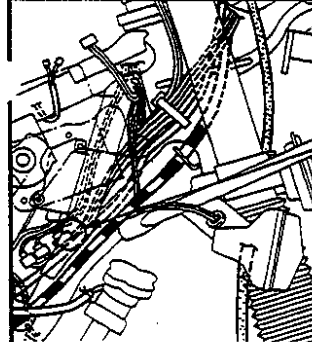

INCORRECT

Main switch is faulty, replace it.

↓
CORRECT

7. Sidestand switch

- Disconnect the sidestand switch coupler from the wireharness.
- Check the switch component for the continuity between "Blue/Yellow ① and Black ①". Refer to the "CHECKING OF SWITCHES" section.

IGNITION AND STARTING SYSTEM

ELEC

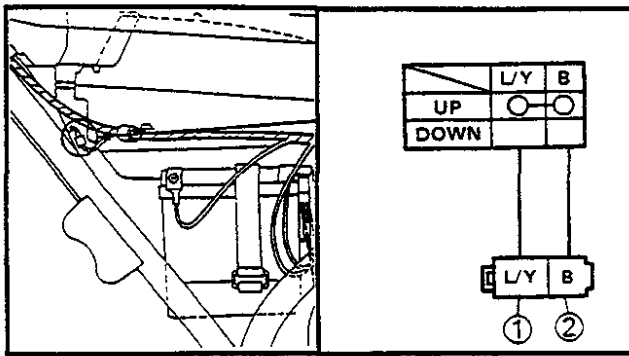

INCORRECT

Sidestand switch is faulty, replace it.

CORRECT

8. Neutral switch

- Disconnect the neutral switch lead from the wireharness.
- Check the switch component for the continuity between "Sky blue ① and Ground". Refer to the "CHECKING OF SWITCHES" section.

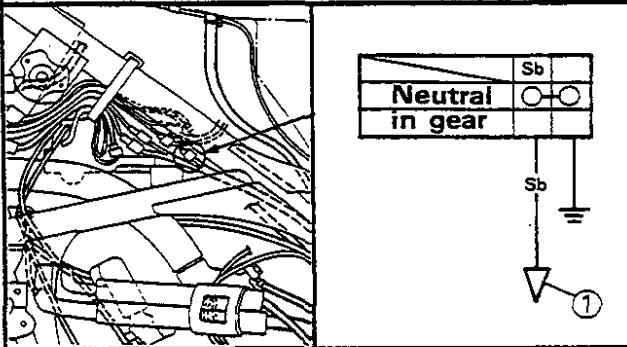

INCORRECT

Neutral switch is faulty, replace it.

CORRECT

9. Pickup coil resistance

- Disconnect the CDI magneto coupler from the wireharness.
- Connect the Pocket Tester ($\Omega \times 100$) to the pickup coil leads.

Tester (+) Lead → White/Green ① Lead
 Tester (-) Lead → White/Black ② Lead

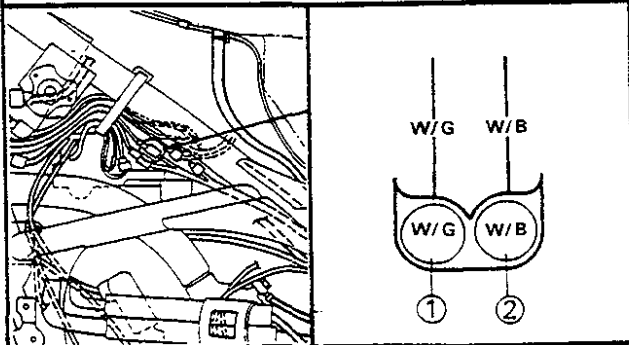



- Check the pickup coil for specified resistance.



Pickup Coil Resistance:
 188 ~ 282Ω at 20°C (68°F)
 (White/Green—White/Black)

OUT OF SPECIFICATION

Pickup coil is faulty, replace it.

MEET SPECIFICATION

10. Source coil resistance

- Disconnect the CDI magneto coupler from the wireharness.
- Connect the Pocket Tester ($\Omega \times 10$) to the source coil leads.

For Source Coil (1):

Tester (+) Lead → Brown ① Lead
 Tester (-) Lead → Green ② Lead

For Source Coil (2):

Tester (+) Lead → Brown ① Lead
 Tester (-) Lead → Red ③ Lead

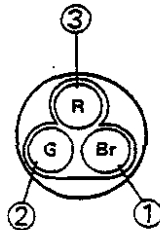
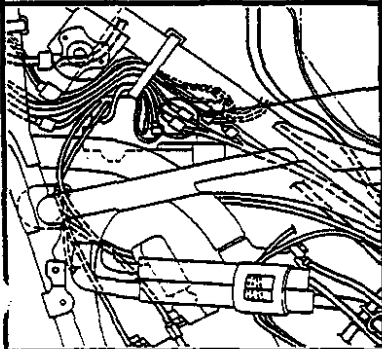

- Check the source coil for specified resistance.



Source Coil (1) Resistance:
 129 ~ 193Ω at 20°C (68°F)
 (Brown—Green)
Source Coil (2) Resistance:
 3.6 ~ 5.4Ω at 20°C (68°F)
 (Brown—Red)

OUT OF SPECIFICATION

Source coil is faulty, replace it.

BOTH MEET SPECIFICATIONS

*

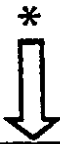

11. Wiring connection
Check the entire ignition system for connections. Refer to the "WIRING DIAGRAM" section.

POOR CONNECTION



Correct.



CORRECT

CDI unit/YPVS control unit is faulty, replace it.



CHARGING SYSTEM

CIRCUIT DIAGRAM

Below circuit diagram shows charging circuit.

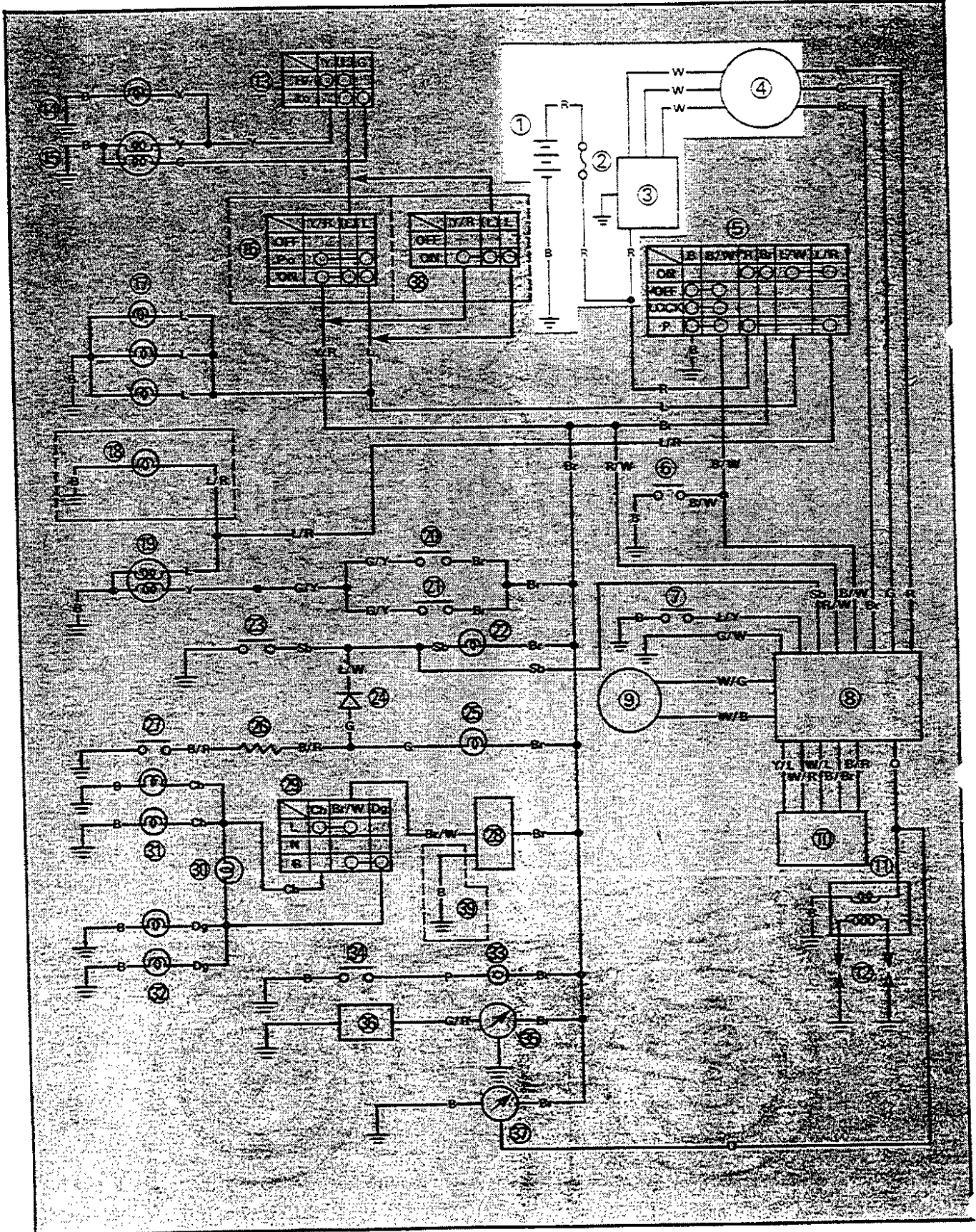

CHARGING SYSTEM

ELEC



NOTE: _____

For the color codes, see page 8-2.

- ① Battery
- ② Circuit breaker
- ③ Rectifier/Regulator
- ④ CDI magneto (Stator coil)

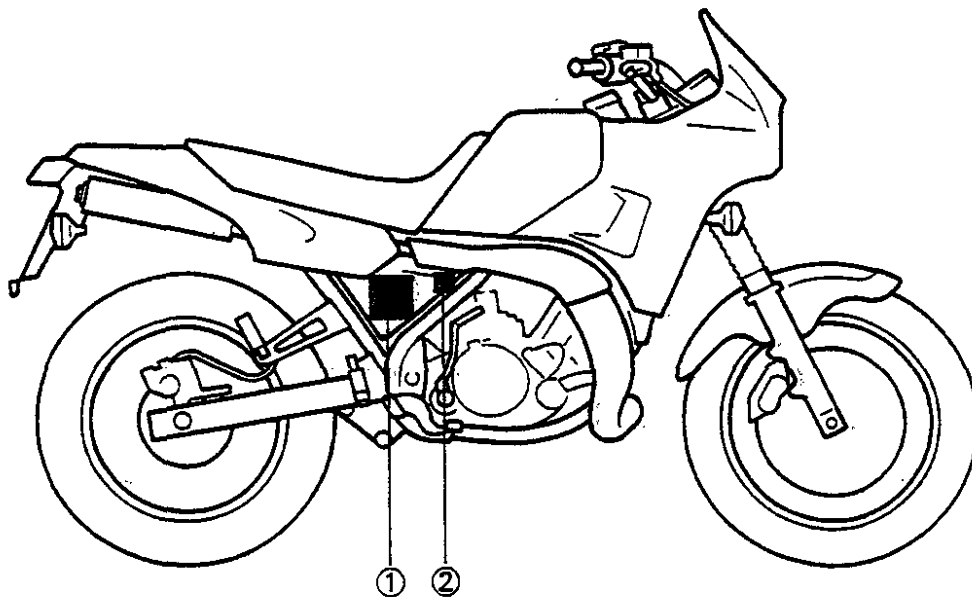
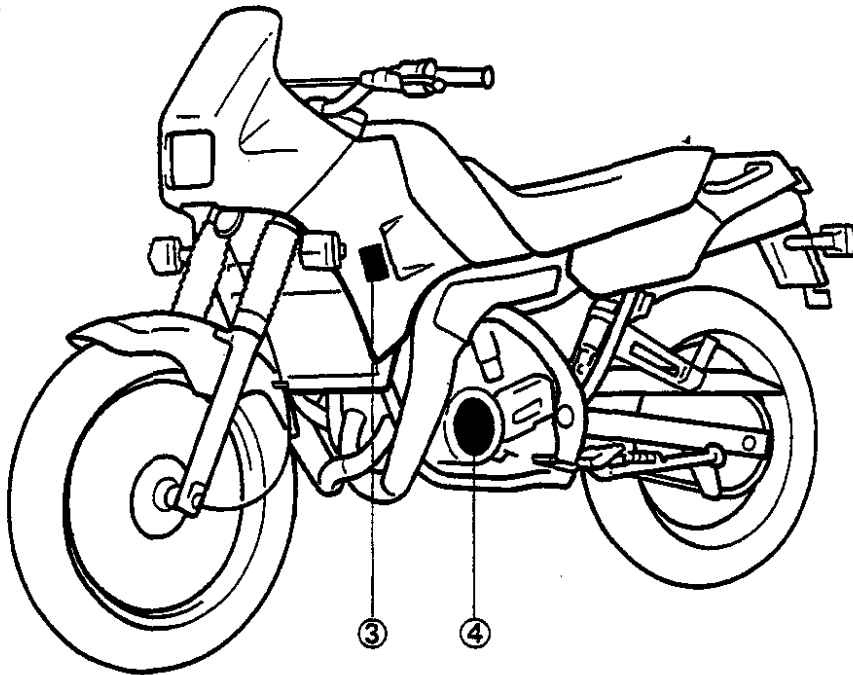



TROUBLESHOOTING

THE BATTERY IS NOT CHARGED.

Procedure

Check;

- | | |
|--------------------|---------------------------|
| 1. Circuit breaker | 4. Stator coil resistance |
| 2. Battery | 5. Wiring connection |
| 3. Charging output | (Entire charging system) |

NOTE:

- Remove the following parts before troubleshooting.

1) Lower cowling (Left)	4) Seat
2) Lower cowling (Right)	5) Side cover (Left)
3) Fuel tank	6) Side cover (Right)
- Use the following special tool(s) in this troubleshooting.



Inductive Tachometer:
P/N. 90890-03113



Pocket Tester:
P/N. 90890-03112

1. Circuit breaker

- Disconnect the circuit breaker leads from the wireharness.
- Connect the Pocket Tester ($\Omega \times 1$) to the circuit breaker leads.
- Push in the breaker knob and check the circuit breaker for continuity.

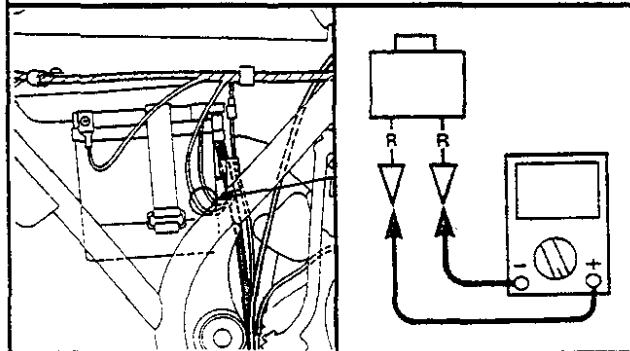

NOCONTINUITY

Circuit breaker is faulty replace it.

CONTINUITY

*



2. Battery

Check the battery condition. Refer to the "BATTERY INSPECTION" section in the CHAPTER 3.

Specific Gravity:
1.280 at 20°C (68°F)

INCORRECT

- Refill battery fluid.
- Clean battery terminals.
- Recharge or replace battery.



CORRECT

3. Charging output

- Disconnect the battery positive lead (Red) from the wireharness.
- Connect the Inductive Tachometer to the spark plug lead.
- Connect an ammeter ("DC A" range) to the battery positive lead.

Tester (+) Lead → Circuit Breaker ① Lead

Tester (-) Lead → Battery Positive ② Lead

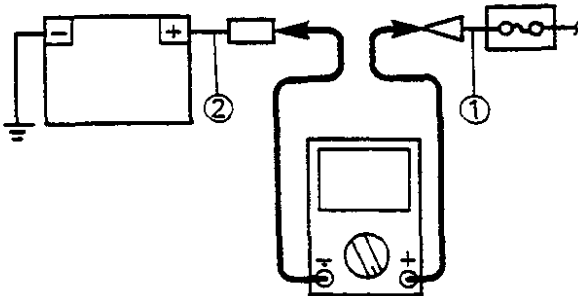

- Start the engine.
- Accelerate the engine to specifications and check the charging amperage.

CAUTION:

Never disconnect the leads from the battery before stopping the engine.



Charging Output Amperage:
7.0A or more at 2.000 r/min
12.0A or more at 5.000 r/min

MEETS SPECIFICATION

Charging system is good.



OUT OF SPECIFICATION



4. Charging coil resistance

- Disconnect the CDI magneto coupler from the wireharness.
- Connect the Pocket Tester ($\Omega \times 1$) to the stator coil leads.

Stator Coil (1):
 Tester (+) Lead → White Lead ①
 Tester (-) Lead → White Lead ②

Stator Coil (2):
 Tester (+) Lead → White Lead ①
 Tester (-) Lead → White Lead ③

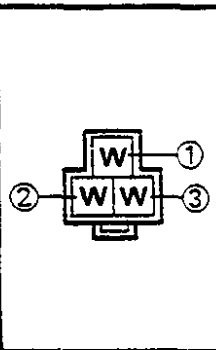

- Check the stator coil for specified resistance.

 **Stator Coil Resistance:**
 White ① – White ②
 0.44 – 0.66 Ω at 20°C (68°F)
 White ① – White ③
 0.44 – 0.66 Ω at 20°C (68°F)

OUT OF SPECIFICATION

Stator coil is faulty, replace it.

BOTH RESISTANCES MEET SPECIFICATIONS

5. Wiring connection

Check the entire charging system for connections. Refer to the "WIRING DIAGRAM" section.

POOR CONNECTION

Correct.

CORRECT

Rectifier/Regulator is faulty, replace it.



LIGHTING SYSTEM

CIRCUIT DIAGRAM

Below circuit diagram shows lighting circuit.

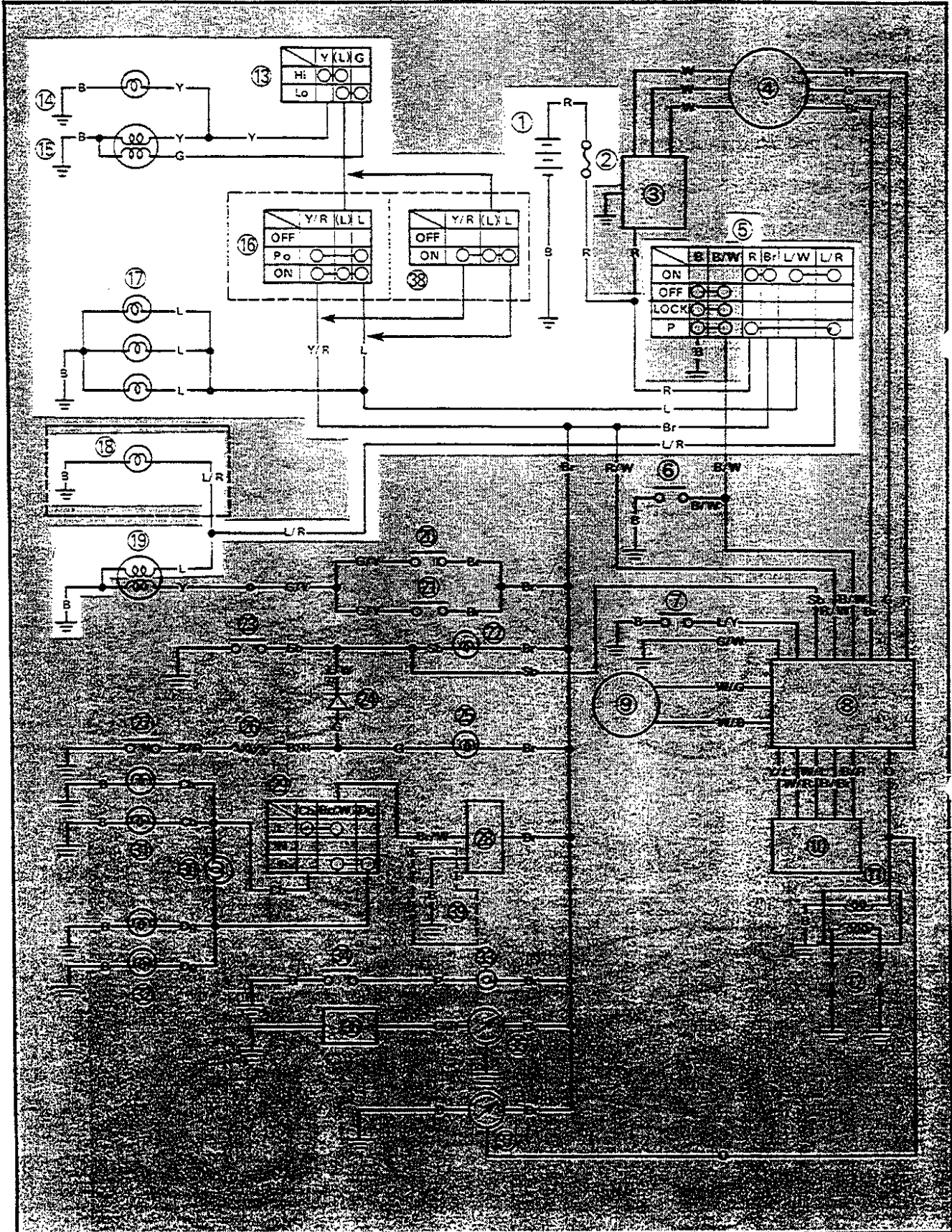

LIGHTING SYSTEM

ELEC



NOTE: _____

For the color codes, see page 8-2.

- ① Battery
- ② Circuit breaker
- ⑤ Main switch
- ⑬ "LIGHTS" (Dimmer) switch
- ⑭ "HIGH BEAM" indicator light
- ⑮ Headlight
- ⑯ "LIGHTS" switch (Except for England)
- ⑰ Meter light
- ⑱ Auxiliary light (Except for England)
- ⑲ Tail/Brake light
- ⑳ "LIGHTS" switch (For England)

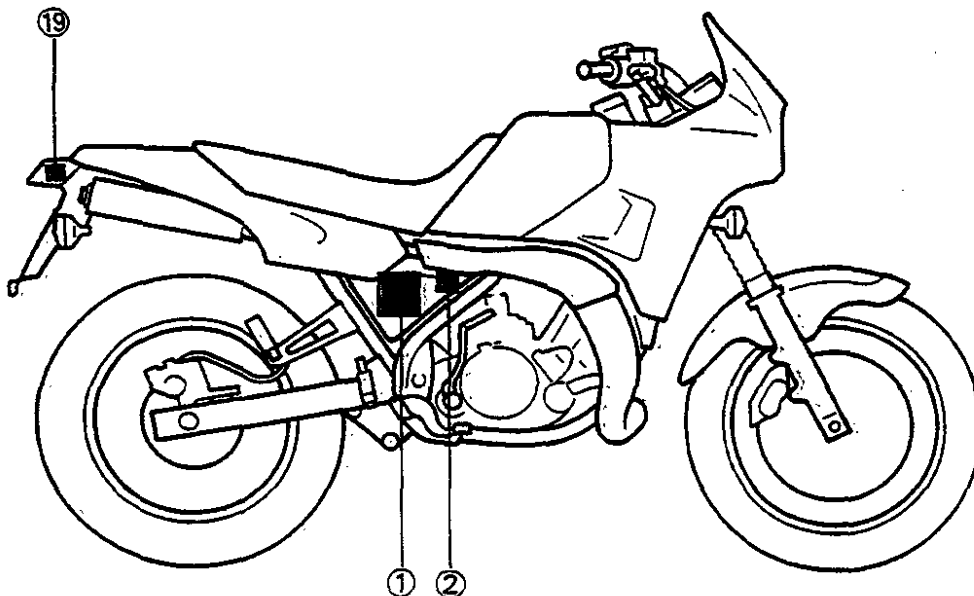
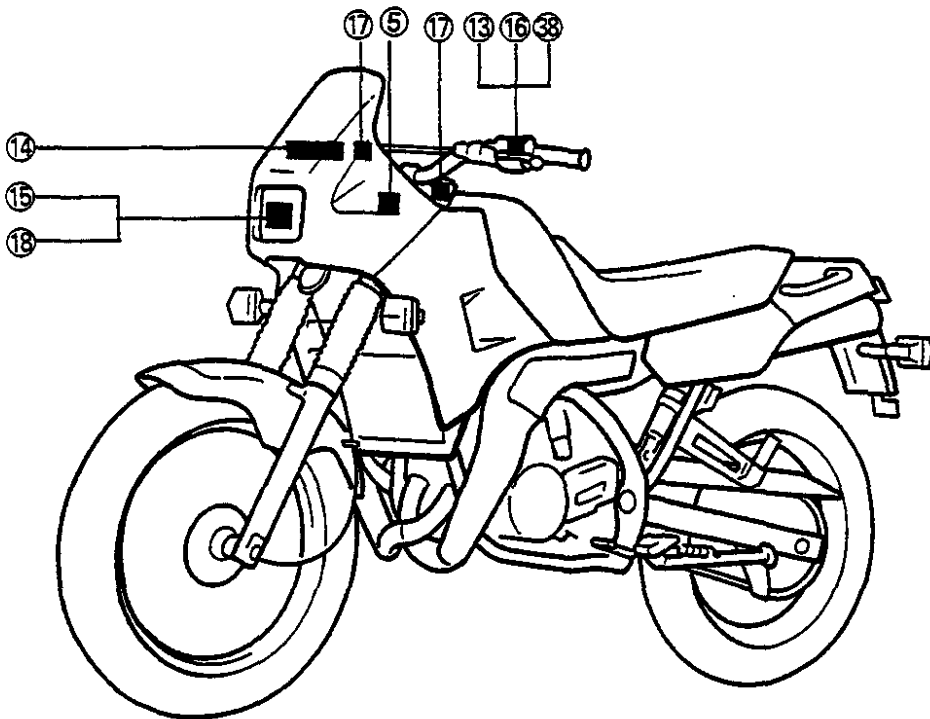



TROUBLESHOOTING

HEADLIGHT "HIGH BEAM" INDICATOR LIGHT, TAILLIGHT, AUXILIARY LIGHT AND/OR METER LIGHT DO NOT COME ON.

Procedure

Check;

1. Circuit breaker
2. Battery
3. Main switch
4. "LIGHTS" switch
5. "LIGHTS" (Dimmer) switch
6. Wiring connection
(Entire lighting system)

NOTE:

- Remove the following parts before troubleshooting.
 - 1) Upper cowling
 - 2) Lower cowling (Left)
 - 3) Lower cowling (Right)
 - 4) Fuel tank
 - 5) Seat
 - 6) Side cover (Right)
- Use the following special tool(s) in this troubleshooting.



Pocket Tester:
P/N. 90890-03112

1. Circuit breaker

- Disconnect the circuit breaker leads from the wireharness.
- Connect the Pocket Tester ($\Omega \times 1$) to the circuit breaker leads.
- Push in the breaker knob and check the circuit breaker for continuity.

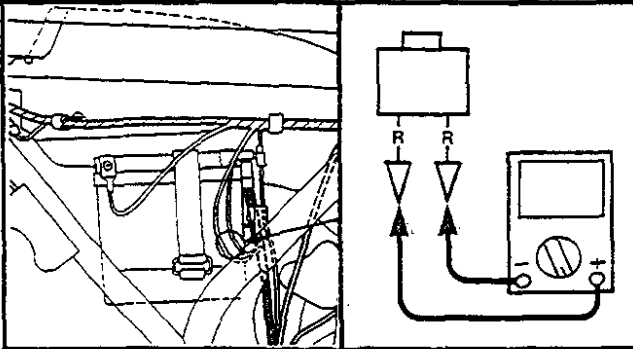

NOCONTINUITY

Circuit breaker is faulty replace it.

CONTINUITY

*



2. Battery

Check the battery condition. Refer to the "BATTERY INSPECTION" section in the CHAPTER 3.

Specific Gravity:
1.280 at 20°C (68°F)

INCORRECT

- Refill battery fluid.
- Clean battery terminals.
- Recharge or replace battery.

CORRECT

3. Main switch

- Disconnect the main switch coupler from the wireharness.
- Check the switch component for the continuity between "Red ① and Brown ②", "Blue/White ③ and Blue/Red ④" and "Red ① and Blue/Red ④". Refer to the "CHECKING OF SWITCHES" section.

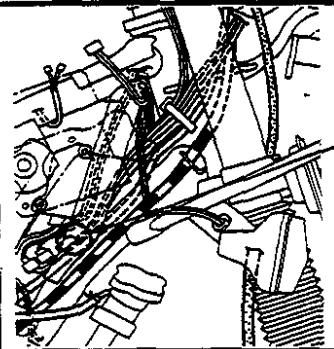

	B	B/W	R	B	L/W	L/R
ON	○	○	○	○	○	○
OFF	○	○	○	○	○	○
LOCK	○	○	○	○	○	○
P	○	○	○	○	○	○

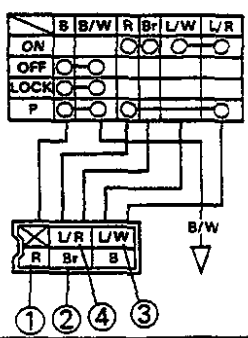

INCORRECT

Main switch is faulty, replace it.

CORRECT

4. "LIGHTS" switch

- Disconnect the handlebar switch (Left) coupler from the wireharness.
- Check the switch component for the continuity between "Yellow/Red ① and Blue ②". Refer to the "CHECKING OF SWITCHES" section.

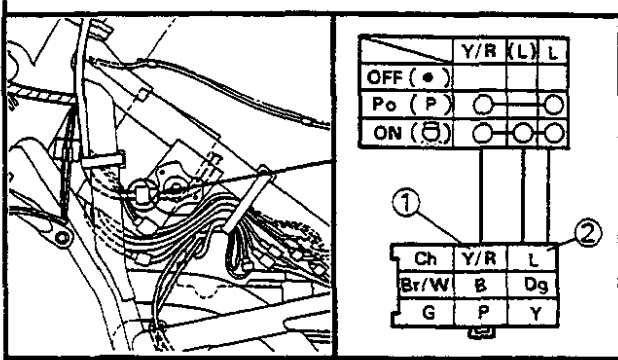

INCORRECT

"LIGHTS" switch is faulty, replace handlebar switch (Left).

CORRECT

5. "LIGHTS" (Dimmer) switch

- Turn the "LIGHTS" switch to "ON" position.
- Check the switch component for the continuity between "Blue ① and Yellow ②" and "Blue ① and Green ③". Refer to the "CHECKING OF SWITCHES" section.

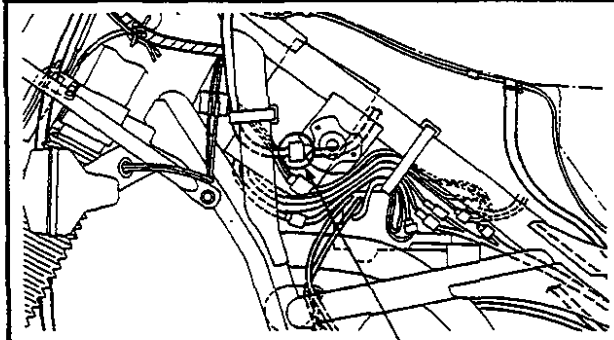

INCORRECT

"LIGHTS" (Dimmer) switch is faulty, replace handlebar switch (Left).

CORRECT

6. Wiring connection

Check the entire lighting system for connections. Refer to the "WIRING DIAGRAM" section.

POOR CONNECTION

Correct.

CORRECT

*



Check condition of each circuit for lighting system. Refer to "LIGHTING SYSTEM CHECK" section.

LIGHTING SYSTEM CHECK

1. Headlight and "HIGH BEAM" indicator light do not come on.

1. Bulb and bulb socket

Check the bulb and bulb socket for continuity. Refer to the "CHECKING OF BULBS" section.

NOCONTINUITY

Bulb and/or bulb socket are faulty, replace.

CONTINUITY

2. Voltage

- Connect the Pocket Tester (DC20V) to the "LIGHTS" switch connector.

Tester (+) Lead → Yellow/Red ① Lead
 Tester (-) Lead → Black ② Lead

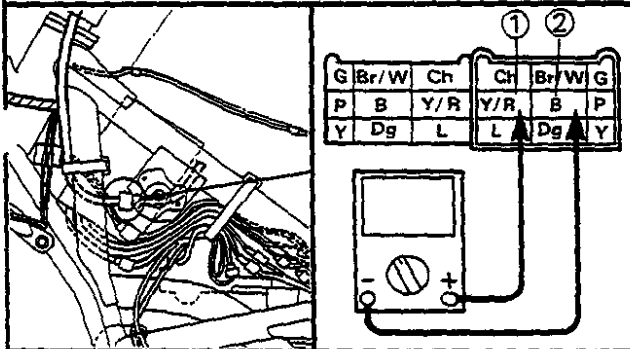

OUT OF SPECIFICATION

Wiring circuit from main switch to "LIGHTS" switch connector is faulty, repair.

MEETS SPECIFICATION (12V)

This circuit is good.



2. Meter light does not come on.

1. Bulb and bulb socket

Check the bulb and bulb socket for continuity. Refer to the "CHECKING OF BULBS" section.

NOCONTINUITY

Bulb and/or bulb socket are faulty, replace.

CONTINUITY

2. Voltage

• Connect the Pocket Tester (DC20V) to the bulb socket leads.

Tester (+) Lead → Blue ① Lead
 Tester (-) Lead → Black ② Lead

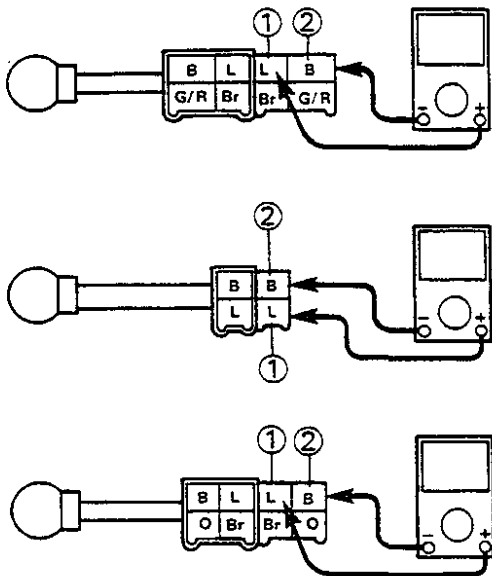

- A** Bulb of the temperaturer gauge
- B** Bulb of the speedometer
- C** Bulb of the tachometer

OUT OF SPECIFICATION

• Turn the main switch to "ON".
 • Turn the "LIGHTS" switch to "ON".
 • Check for voltage (12V) on the "Blue" lead at the bulb socket connector.

Wiring circuit from main switch to bulb socket connector is faulty, repair.

MEETS SPECIFICATION (12V)

This circuit is good.



3. Auxiliary light does not come on.

1. Bulb and bulb socket

Check the bulb and bulb socket for continuity. Refer to the "CHECKING OF BULBS" section.

NOCONTINUITY

Bulb and/or bulb socket are faulty, replace.

CONTINUITY

2. Voltage

- Connect the Pocket Tester (DC20V) to the bulb socket connector.

Tester (+) Lead → Blue/Red ① Lead
 Tester (-) Lead → Black ② Lead

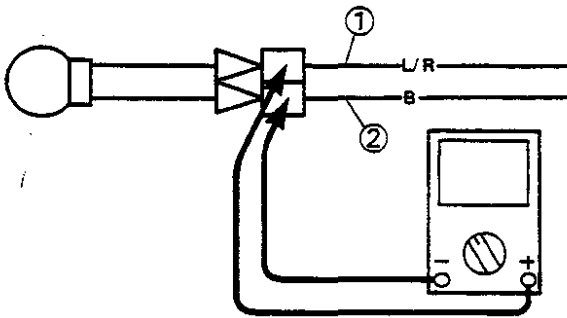

OUT OF SPECIFICATION

Wiring circuit from main switch to bulb socket connector is faulty, repair.

- Turn the main switch to "ON".
- Turn the "LIGHTS" switch to "ON".
- Check for voltage (12V) on the "Blue/Red" lead at the bulb socket connector.

MEETS SPECIFICATION (12V)

This circuit is good.



4. Taillight does not come on.

1. Bulb and bulb socket

Check the bulb and bulb socket for continuity. Refer to the "CHECKING OF BULBS" section.

NOCONTINUITY

Bulb and/or bulb socket are faulty, replace.

CONTINUITY

2. Voltage

•Connect the Pocket Tester (DC20V) to the bulb socket connector.

Tester (+) Lead → Blue ① Lead
 Tester (-) Lead → Black ② Lead

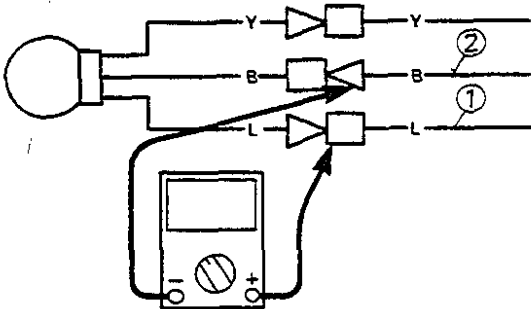

OUT OF SPECIFICATION

Wiring circuit from main switch to bulb socket connector is faulty, repair.

•Turn the main switch to "ON".
 •Turn the "LIGHTS" switch to "ON".
 •Check for voltage (12V) on the "Blue" lead at the bulb socket connector.

MEETS SPECIFICATION (12V)

This circuit is good.



SIGNAL SYSTEM

CIRCUIT DIAGRAM

Below circuit diagram shows signal circuit.

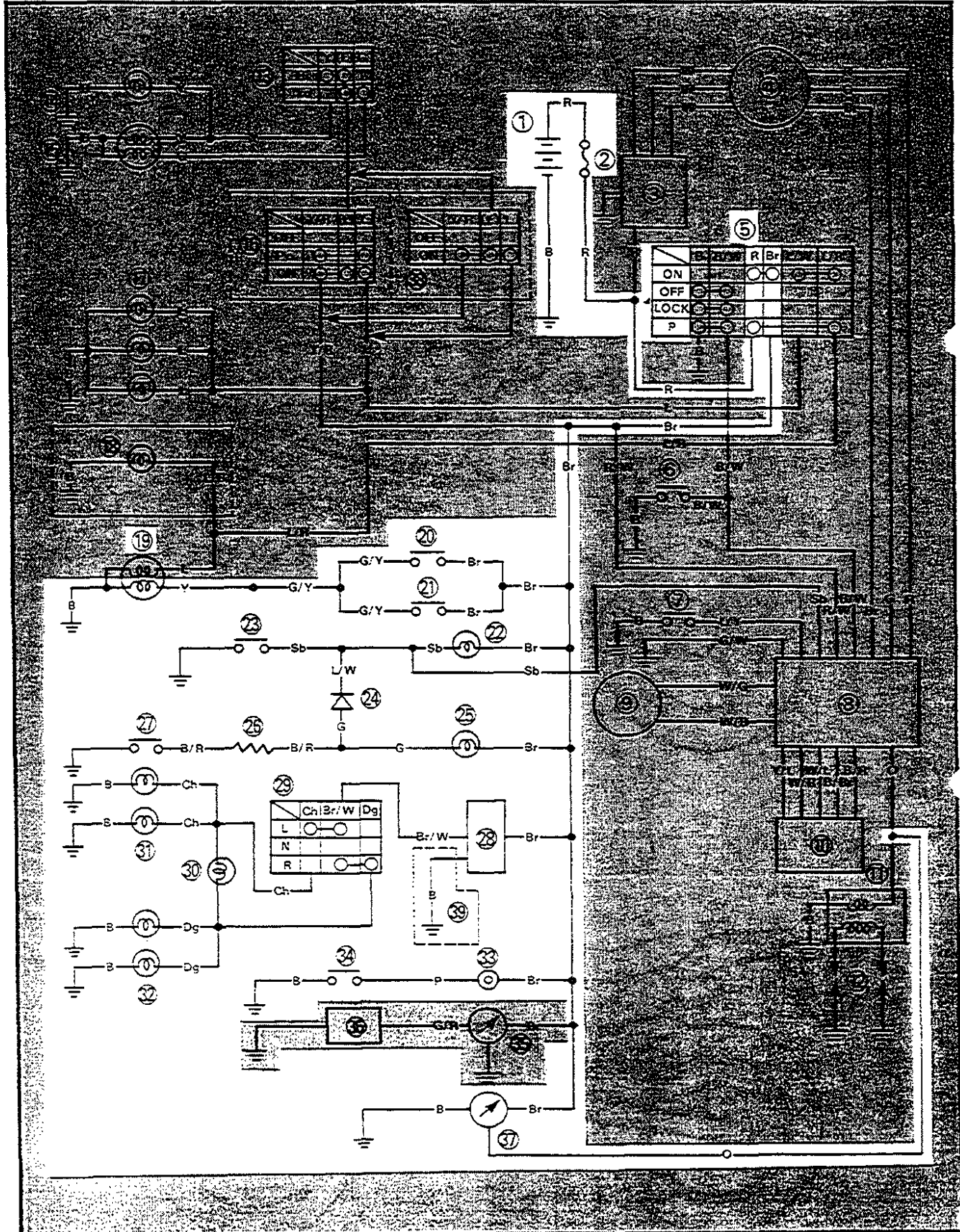

SIGNAL SYSTEM

ELEC



NOTE: _____

For the color codes, see page 8-2.

- | | |
|------------------------------|---------------------------|
| ① Battery | ②⑥ Resistor |
| ② Circuit breaker | ②⑦ Oil level gauge |
| ⑤ Main switch | ②⑧ Flasher relay |
| ①⑨ Tail/Brake light | ②⑨ "TURN" switch |
| ②⑩ Front brake switch | ③⑩ "TURN" indicator light |
| ②⑪ Rear brake switch | ③① Flasher light (Left) |
| ②⑫ "NEUTRAL" indicator light | ③② Flasher light (Right) |
| ②⑬ Neutral switch | ③③ Horn |
| ②⑭ Diode | ③④ "HORN" switch |
| ②⑮ "OIL" indicator light | ③⑦ Tachometer |

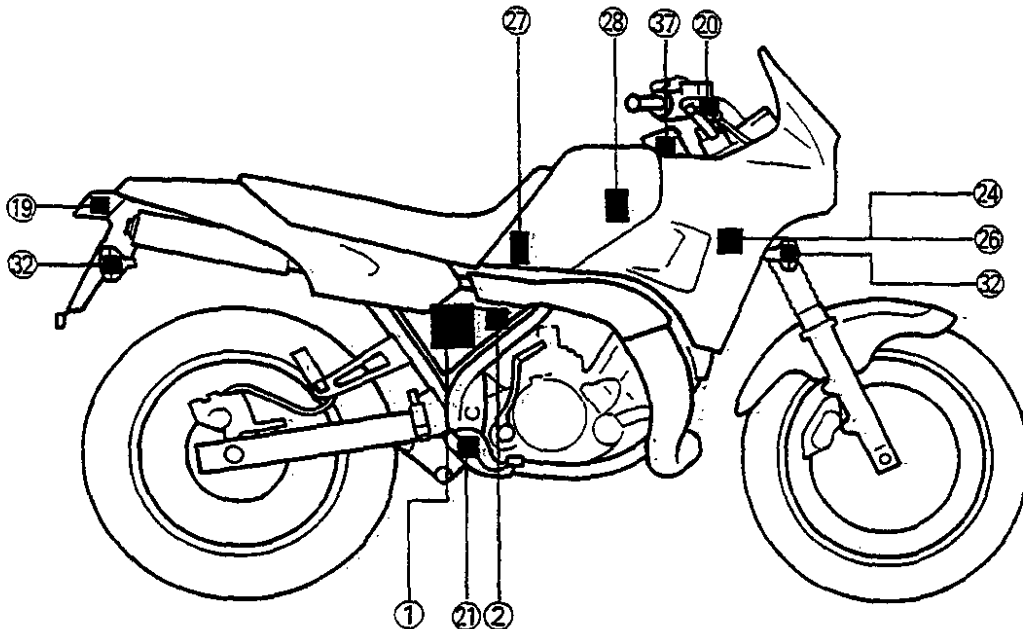
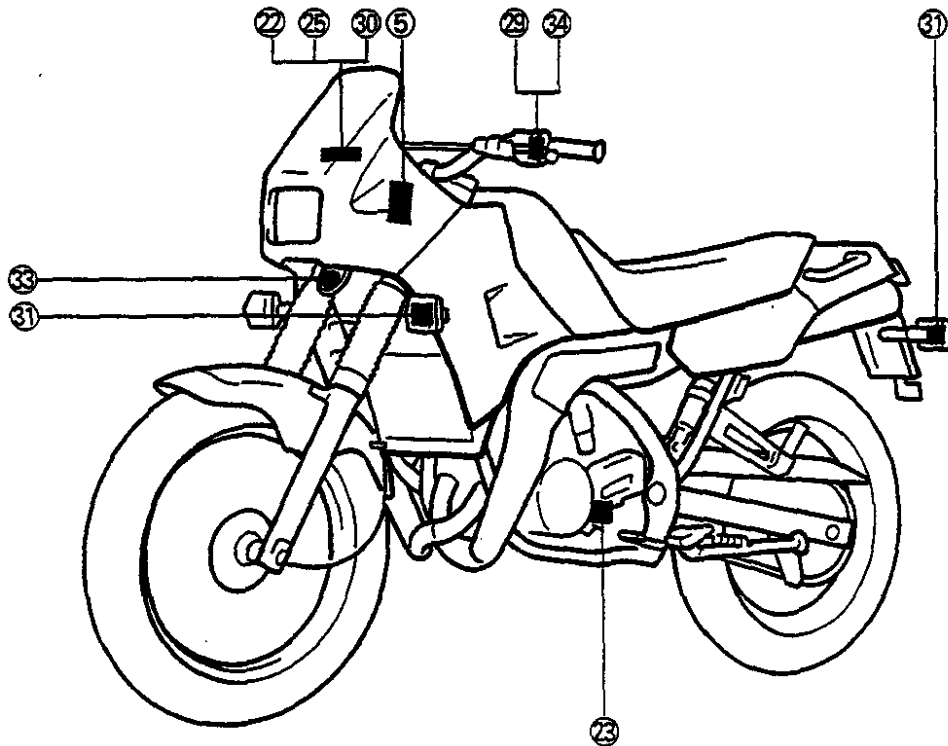

TROUBLESHOOTING

- FLASHER LIGHT, BRAKE LIGHT AND/OR INDICATOR LIGHT DO NOT COME ON.
- HORN DOES NOT SOUND.
- TACHOMETER DOES NOT OPERATE.

Procedure

Check;

1. Circuit breaker
2. Battery
3. Main switch
4. Wiring connection
(Entire signal system)

NOTE:

- Remove the following parts before troubleshooting.
 - 1) Seat
 - 2) Upper cowling
 - 3) Lower cowling (Left)
 - 4) Lower cowling (Right)
 - 5) Fuel tank
 - 6) Side cover (Right)
- Use the following special tool(s) in this troubleshooting.

	<p>Pocket Tester: P/N. 90890-03112</p>
--	---

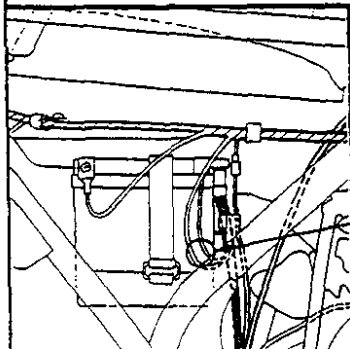
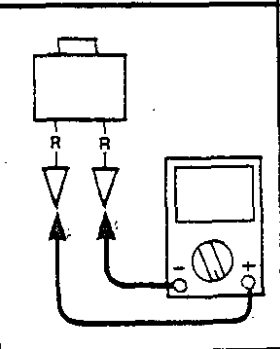
<p>1. Circuit breaker</p> <ul style="list-style-type: none"> • Disconnect the circuit breaker leads from the wireharness. • Connect the Pocket Tester ($\Omega \times 1$) to the circuit breaker leads. • Push in the breaker knob and check the circuit breaker for continuity. 	
	

NOCONTINUITY

Circuit breaker is faulty, replace it.

CONTINUITY

*



2. Battery

Check the battery condition. Refer to the "BATTERY INSPECTION" section in the CHAPTER 3.

Specific Gravity:
1.280 at 20°C (68°F)

INCORRECT

- Refill battery fluid.
- Clean battery terminals.
- Recharge or replace battery.

CORRECT

3. Main switch

- Disconnect the main switch coupler from the wireharness.
- Check the switch component for the continuity between "Red ① and Brown ②". Refer to the "CHECKING OF SWITCHES" section.

INCORRECT

Main switch is faulty, replace it.

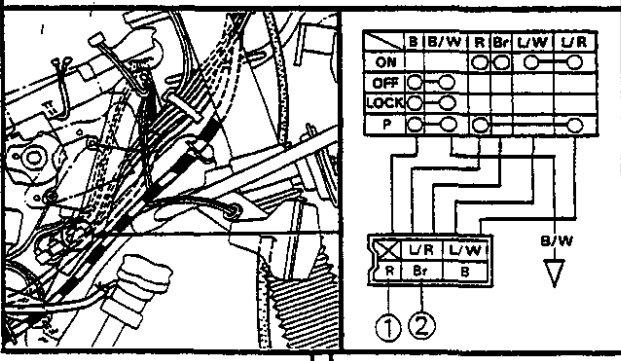

CORRECT

4. Wiring connection

Check the entire signal system for connections. Refer to the "WIRING DIAGRAM" section.

POOR CONNECTION

Correct.

CORRECT

Check condition of each circuit for signal system. Refer to "SIGNAL SYSTEM CHECK" section.

SIGNAL SYSTEM CHECK

1. Horn does not sound.

1. "HORN" switch.

- Disconnect the handlebar switch coupler from the wireharness.
- Check the switch component for the continuity between "Pink ① and Black ②". Refer to the "CHECKING OF SWITCHES" section.

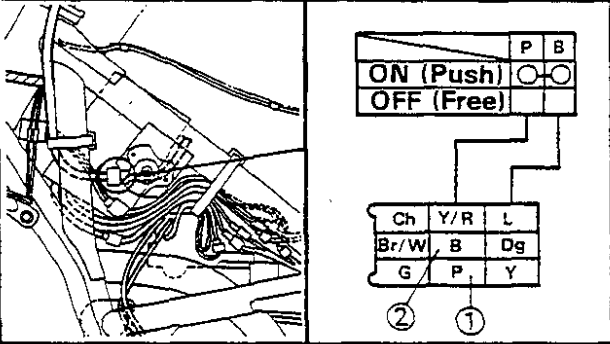

INCORRECT

"HORN" switch is faulty, replace handlebar switch (Left).

CORRECT

2. Voltage

- Connect the Pocket Tester (DC20V) to the horn lead.

Tester (+) Lead → Brown ① Lead
 Tester (-) Lead → Frame Ground

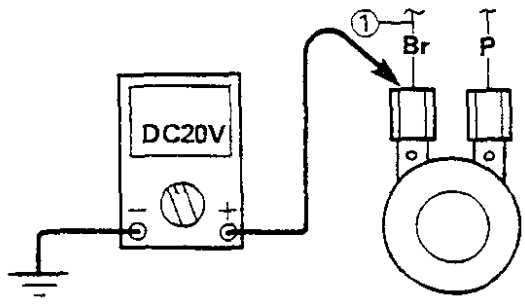

- Turn the main switch to "ON".
- Check for voltage (12V) on the "Brown" lead at the horn terminal.

OUT OF SPECIFICATION

Wiring circuit from main switch to horn terminal is faulty, repair.

MEETS SPECIFICATION (12V)

*



3. Horn

- Disconnect the "Pink" lead at the horn terminal.
- Connect a jumper lead ① to the horn terminal and ground the jumper lead.
- Turn the main switch to "ON".

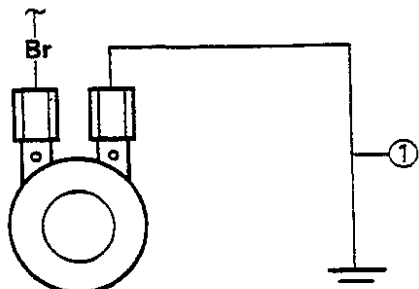

HORN IS SOUNDED

Horn is good.

HORN IS NOT SOUNDED

4. Voltage

- Connect the Pocket Tester (DC20V) to the horn at the Pink terminal.

Tester (+) Lead → Pink ① Lead
 Tester (-) Lead → Frame Ground

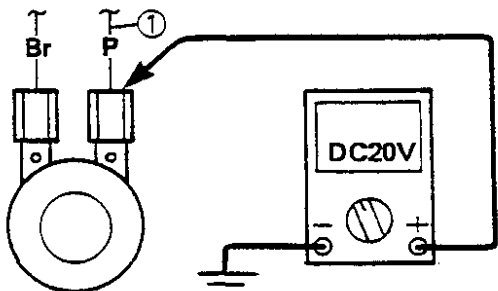

OUT OF SPECIFICATION

Horn is faulty, replace it.

- Turn the main switch to "ON".
- Check for voltage (12V) on the "Pink" lead at the horn terminal.

MEETS SPECIFICATION
 (12V)

Adjust or replace horn.



2. Brake light does not come on.

1. Bulb and bulb socket

Check the bulb and bulb socket for continuity. Refer to the "CHECKING OF BULBS" section.

NOCONTINUITY

Bulb and/or bulb socket are faulty, replace.

CONTINUITY

2. Brake switch

- Disconnect the brake switch coupler from the wireharness.
- Check the switch component for the continuity between "Brown ① and Green/Yellow ②". Refer to the "CHECKING OF SWITCHES" section.

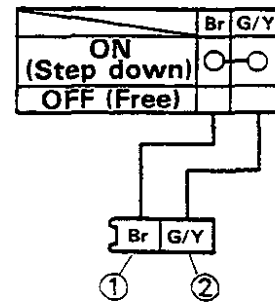
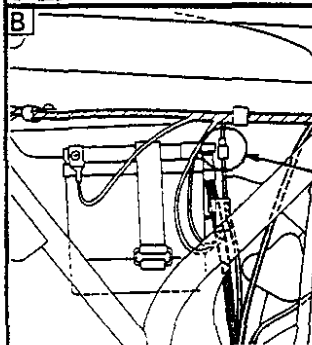
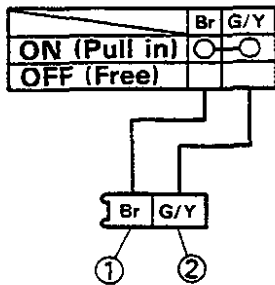
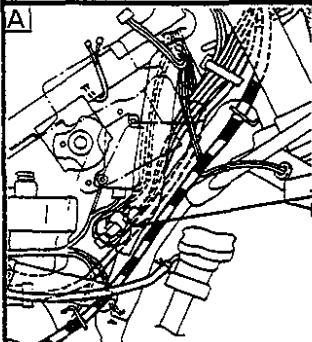

A Front brake switch
B Rear brake switch

INCORRECT

Brake switch is faulty, replace it.

CORRECT

3. Voltage

- Connect the Pocket Tester (DC20V) to the bulb socket connector.

Tester (+) Lead → Blue ① Lead
Tester (-) Lead → Black ② Lead

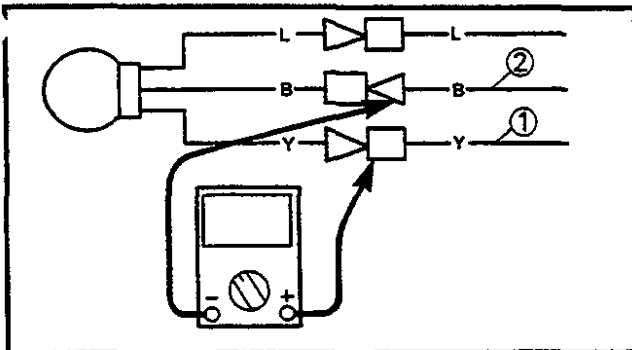

- Turn the main switch to "ON".
- The brake lever is pulled in or brake pedal is stepped down.
- Check for voltage (12V) on the "Yellow" lead at the bulb socket connector.

OUT OF SPECIFICATION

Wiring circuit from main switch to bulb socket connector is faulty, repair.

MEETS SPECIFICATION (12V)

This circuit is good.

3. Flasher light and/or "TURN" indicator light do not blink.

1. Bulb and bulb socket

Check the bulb and bulb socket for continuity. Refer to the "CHECKING OF BULBS" section.

NOCONTINUITY

Bulb and/or bulb socket are faulty, replace.

CONTINUITY

2. "TURN" switch

- Disconnect the handlebar switch coupler from the wireharness.
- Check the switch component for the continuity between "Brown/White ① and Chocolate ②" and "Brown/White ① and Dark green ③". Refer to the "CHECKING OF SWITCHES" section.

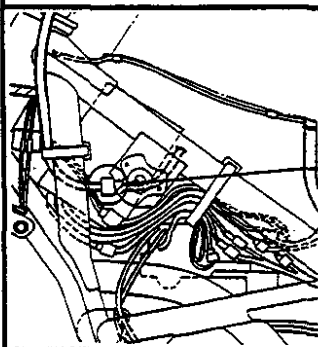

	Ch	Br/W	Dg
L	○	○	
N			
R			○

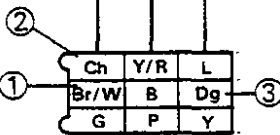

INCORRECT

"TURN" switch is faulty, replace handlebar switch (Left).

CORRECT

*



3. Voltage

- Connect the Pocket Tester (DC20V) to the flasher relay.

Tester (+) Lead → Brown ① Lead
Tester (-) Lead → Frame Ground

- Turn the main switch to "ON".
- Check for voltage (12V) on the "Brown" lead at the flasher relay terminal.

OUT OF SPECIFICATION

Wiring circuit from main switch to flasher relay connector is faulty, repair.

MEETS SPECIFICATION (12V)

4. Voltage

- Connect the Pocket Tester (DC20V) to the flasher relay.

Tester (+) Lead → Brown/White ① Lead
Tester (-) Lead → Frame Ground

- Turn the main switch to "ON".
- Check for voltage (12V) on the "Brown/White" lead at the flasher relay terminal.

OUT OF SPECIFICATION

Flasher relay is faulty, replace it.

MEETS SPECIFICATION (12V)





5. Voltage

- Connect the Pocket Tester (DC20V) to the bulb socket connector.

At Flasher Light (Left):
 Tester (+) Lead → Chocolate ① Lead
 Tester (-) Lead → Frame Ground

At Flasher Light (Right):
 Tester (+) Lead → Dark green ② Lead
 Tester (-) Lead → Frame Ground

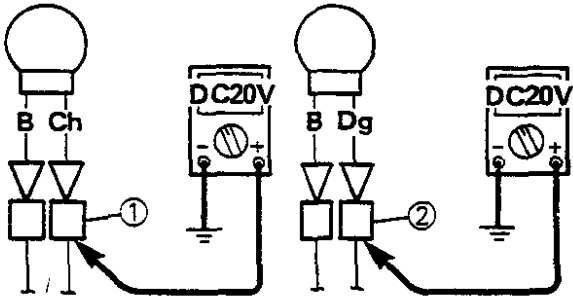

- Turn the main switch to "ON".
- Turn the "TURN" switch to "L" or "R".
- Check for voltage (12V) on the "Chocolate" lead or "Dark green" lead at the bulb socket connector.

OUT OF SPECIFICATION

Wiring circuit from "TURN" switch to bulb socket connector is faulty, repair.

MEETS SPECIFICATION (12V)

This circuit is good.



4. "NEUTRAL" indicator light does not come on.

1. Bulb and bulb socket

Check the bulb and bulb socket for continuity. Refer to the "CHECKING OF BULBS" section.

NOCONTINUITY

Bulb and/or bulb socket are faulty, replace.

CONTINUITY

2. Neutral switch

- Disconnect the neutral switch lead from the wireharness.
- Check the switch component for the continuity between "Sky blue ① and Ground". Refer to the "CHECKING OF SWITCHES" section.

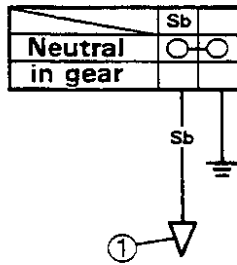
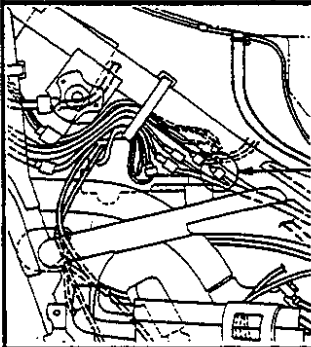

INCORRECT

Neutral switch is faulty, replace it.

CORRECT

3. Voltage

- Connect the Pocket Tester (DC20V) to the bulb socket connector.

Tester (+) Lead → Brown ① Lead
 Tester (-) Lead → Frame Ground

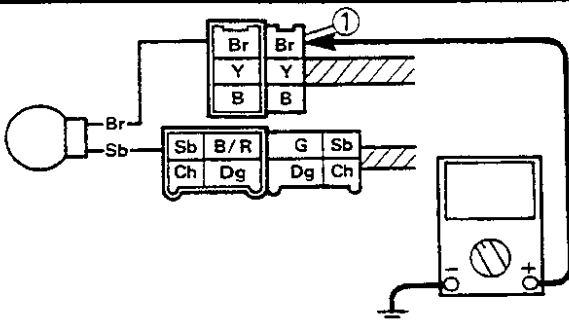

SIGNAL SYSTEM

ELEC



- Turn the main switch to "ON".
- Check for voltage (12V) on the "Brown" lead at bulb socket connector.

OUT OF SPECIFICATION

MEETS SPECIFICATION (12V)

Wiring circuit from main switch to bulb socket connector is faulty, repair.

This circuit is good.

5. "OIL" indicator light does not come on, when transmission is in neutral.

1. Bulb and bulb socket

Check the bulb and bulb socket for continuity. Refer to the "CHECKING OF BULBS" section.

NOCONTINUITY

Bulb and/or bulb socket are faulty, replace.

CONTINUITY

2. Neutral switch

- Disconnect the neutral switch lead from the wireharness.
- Check the switch component for the continuity between "Sky blue ① and Ground". Refer to the "CHECKING OF SWITCHES" section.

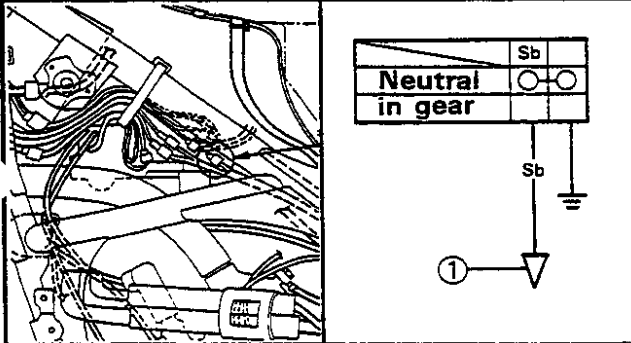

INCORRECT

Neutral switch is faulty, replace it.

CORRECT

3. Diode

- Disconnect the diode unit, coupler from the wireharness.
- Connect the Pocket Tester ($\Omega \times 1$) to the diode leads.

Tester (+) Lead → Blue/White ① Lead
 Tester (-) Lead → Green ② Lead

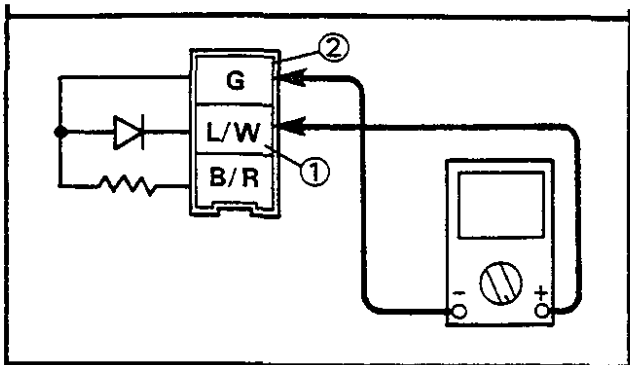

NOCONTINUITY

•Check the diode for continuity.

Diode is faulty, replace diode unit.

CONTINUITY

4. Voltage

•Connect the Pocket Tester (DC20V) to the bulb socket connector.

Tester (+) Lead → Brown ① Lead
Tester (-) Lead → Frame Ground

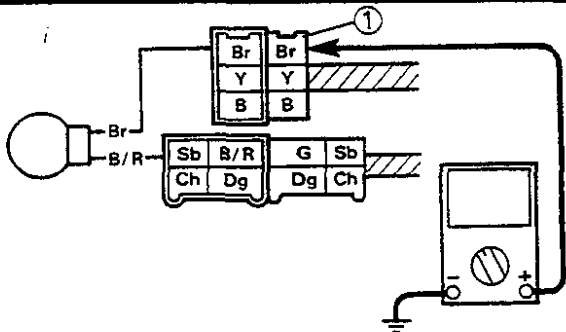

OUT OF SPECIFICATION

•Turn the main switch to "ON".
•Check for voltage (12V) on the "Brown" lead at bulb socket connector.

Wiring circuit from main switch to bulb socket connector is faulty, repair.

MEETS SPECIFICATION (12V)

This circuit is good.



3. "OIL" indicator light does not come on, when transmission is in gear and oil tank is empty.

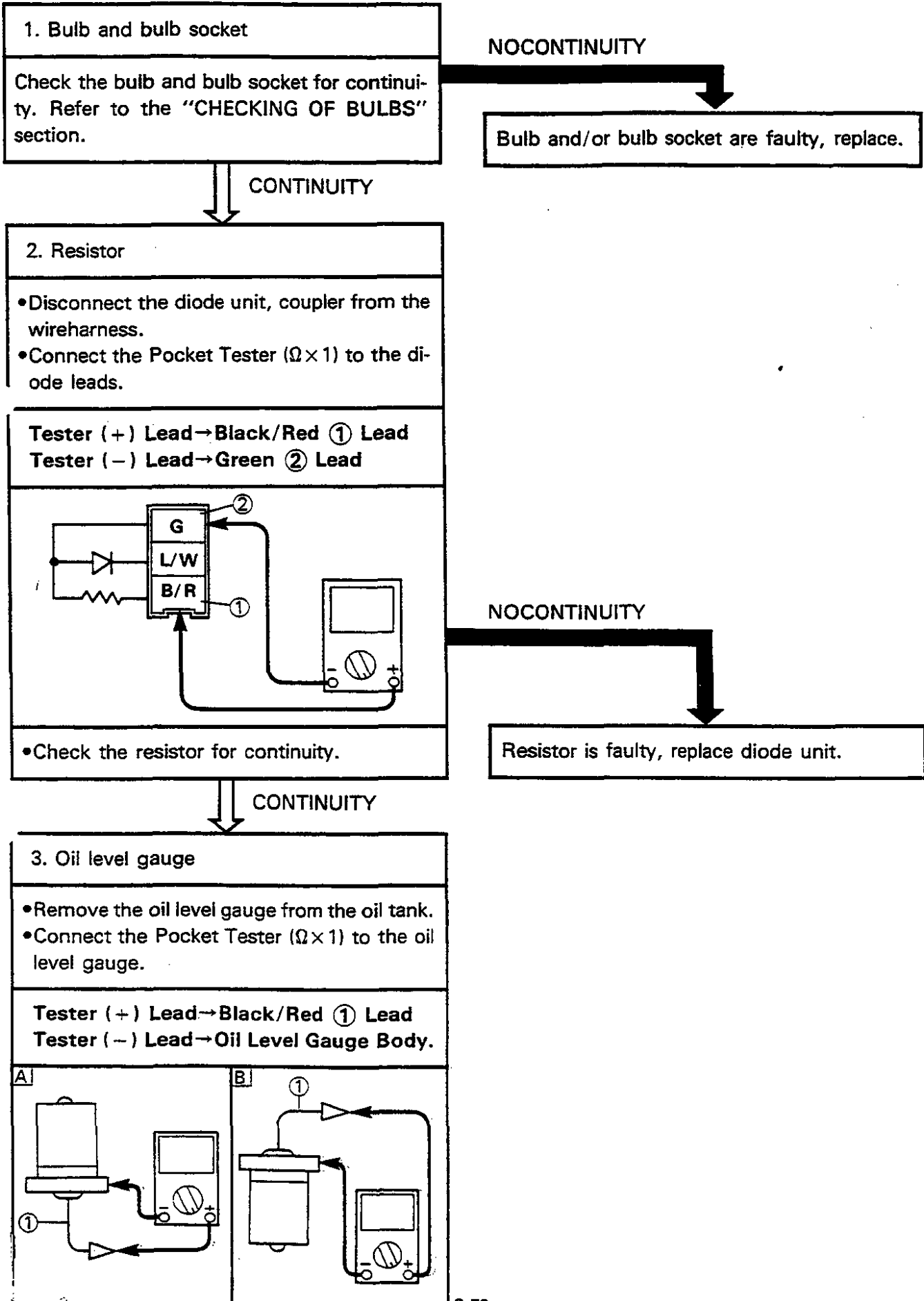

• Check the oil level gauge for continuity.

Switch position	Good condition	Bad condition	
A Upright position	×	○	○
B Upside down position	○	×	○

○: Continuity ×: Nocontinuity

BAD CONDITION

Oil level gauge is faulty, replace it.

GOOD CONDITION

4. Voltage

• Connect the Pocket Tester (DC20V) to the bulb socket connector.

Tester (+) Lead → Brown ① Lead
 Tester (-) Lead → Frame Ground

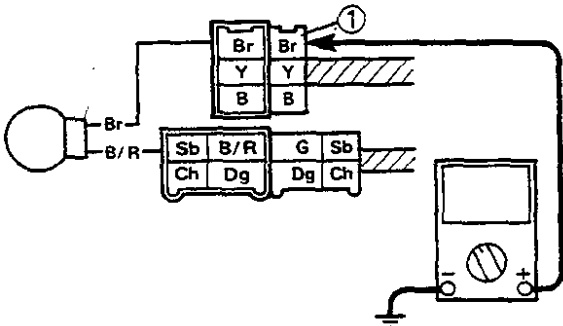

• Turn the main switch to "ON".
 • Check for voltage (12V) on the "Brown" lead at bulb socket connector.

OUT OF SPECIFICATION

Wiring circuit from main switch to bulb socket connector is faulty, repair.

MEETS SPECIFICATION (12V)

This circuit is good.

COOLING SYSTEM

CIRCUIT DIAGRAM

Below circuit diagram shows cooling circuit.

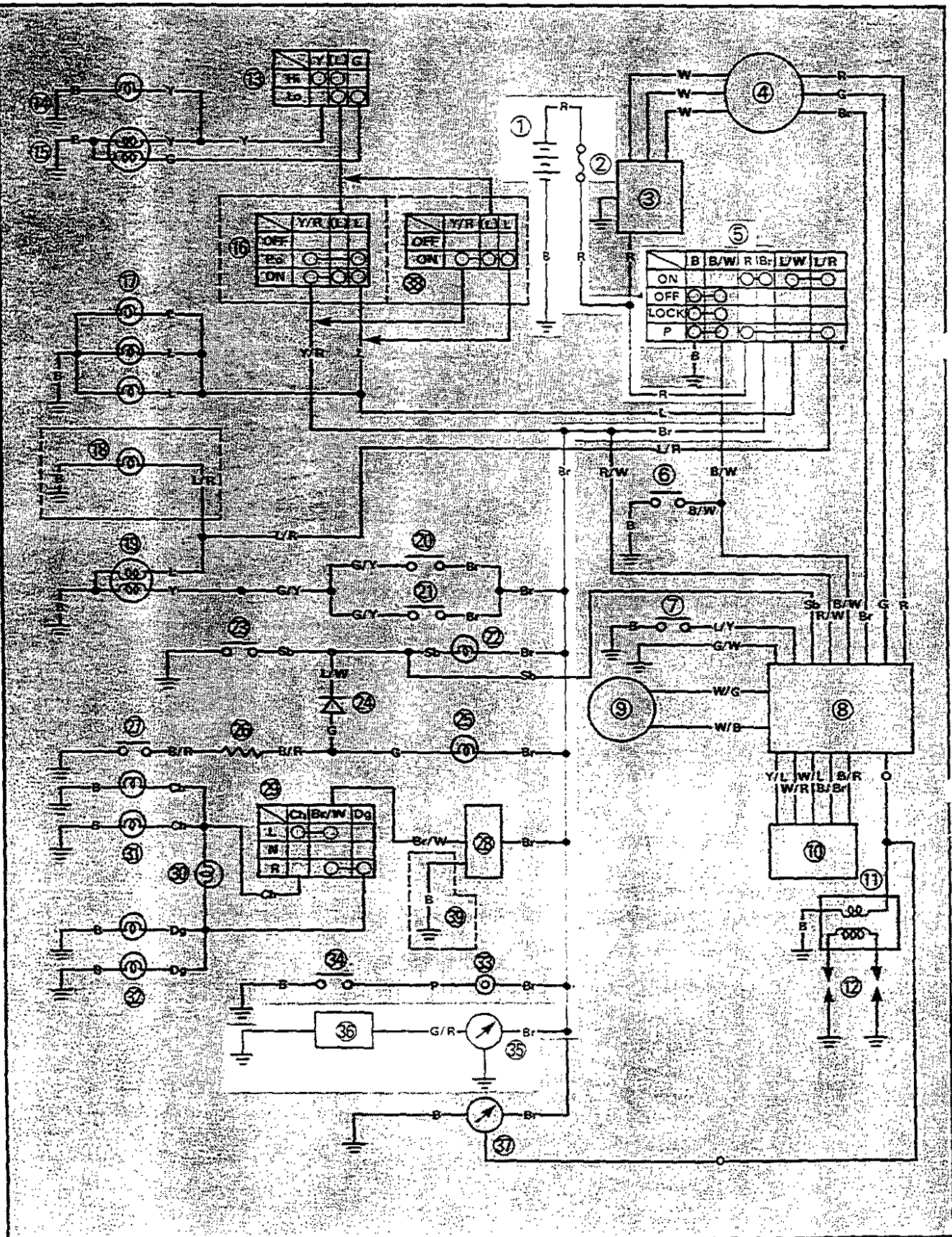

COOLING SYSTEM

ELEC



NOTE: _____

For the color codes, see page 8-2.

- ① Battery
- ② Circuit breaker
- ⑤ Main switch
- ③⑤ Temperature gauge
- ③⑥ Thermo unit

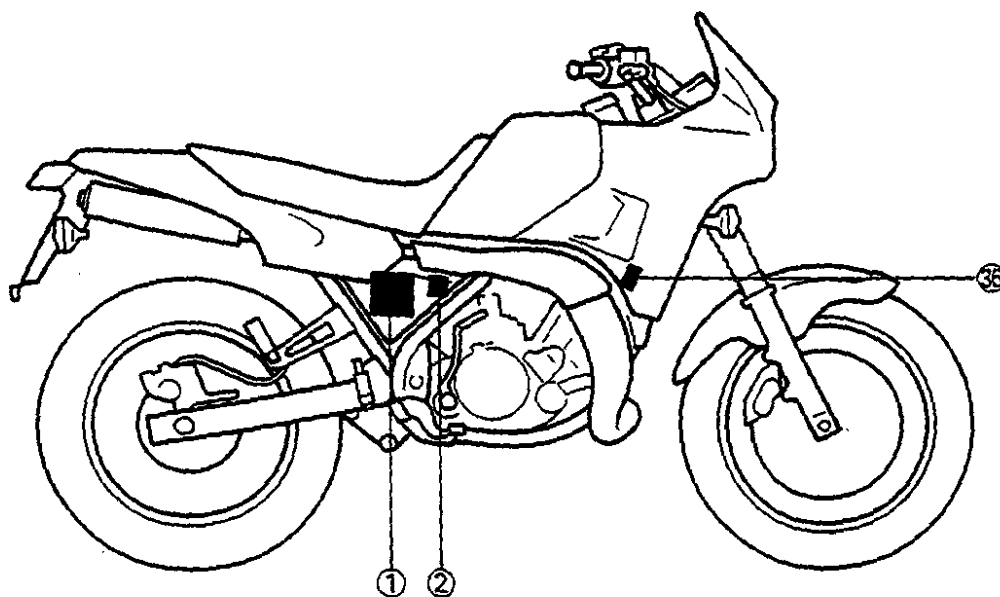
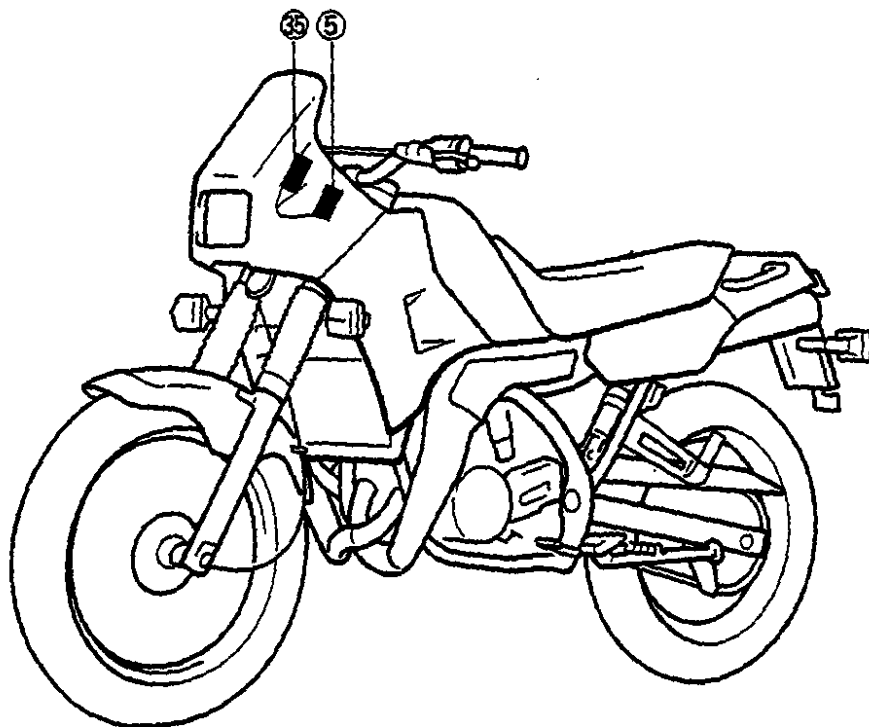



TROUBLESHOOTING

WHEN ENGINE IS HOT, TEMPERATURE GAUGE DOES NOT MOVE.

Procedure

Check;

- | | |
|--------------------|-------------------------|
| 1. Circuit breaker | 5. Voltage |
| 2. Battery | 6. Wiring connection |
| 3. Main switch | (Entire cooling system) |
| 4. Thermo unit | |

NOTE:

- Remove the following parts before troubleshooting.

1) Seat	4) Fuel tank
2) Lower cowling (Left)	5) Side cover (Right)
3) Lower cowling (Right)	
- Use the following special tool(s) in this troubleshooting.



Pocket Tester:
P/N. 90890-03112

1. Circuit breaker

- Disconnect the circuit breaker leads from the wireharness.
- Connect the Pocket Tester ($\Omega \times 1$) to the circuit breaker leads.
- Push in the breaker knob and check the circuit breaker for continuity.

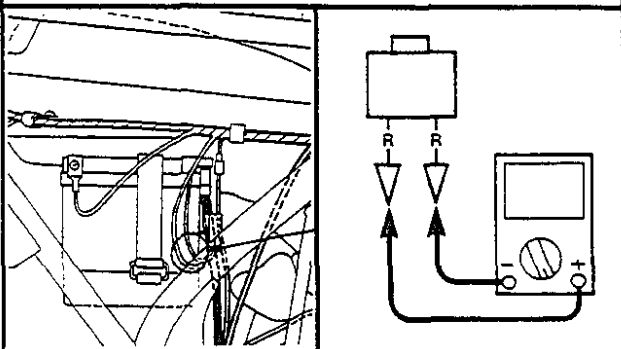

NOCONTINUITY

Circuit breaker is faulty, replace it.

CONTINUITY

*



2. Battery

Check the battery condition. Refer to the "BATTERY INSPECTION" section in the CHAPTER 3.

Specific Gravity:
1.280 at 20°C (68°F)

INCORRECT

- Refill battery fluid.
- Clean battery terminals.
- Recharge or replace battery.

CORRECT

3. Main switch

- Disconnect the main switch coupler from the wireharness.
- Check the switch component for the continuity between "Red ① and Brown ②". Refer to the "CHECKING OF SWITCHES" section.

INCORRECT

Main switch is faulty, replace it.

CORRECT

4. Thermo unit

- Remove the thermo unit.

WARNING:

Handle the thermo unit with special care. Never subject it to strong or allow it to be dropped. Should it be dropped, it must be replaced.



- Immerse the thermo unit ② in coolant ③.
- Measure the resistance at each temperature as tabulated.

① Thermometer

Coolant Temperature	Resistance
50°C (122°F)	154Ω
80°C (176°F)	47 ~ 57Ω
100°C (212°F)	26 ~ 29Ω
120°C (248°F)	16Ω

- After measuring the thermo unit, install the unit.



Thermo Unit:

15 Nm (1.5 m·kg, 11 ft·lb)

Use Water Resistant Sealant.

CAUTION:

Avoid overtightening.

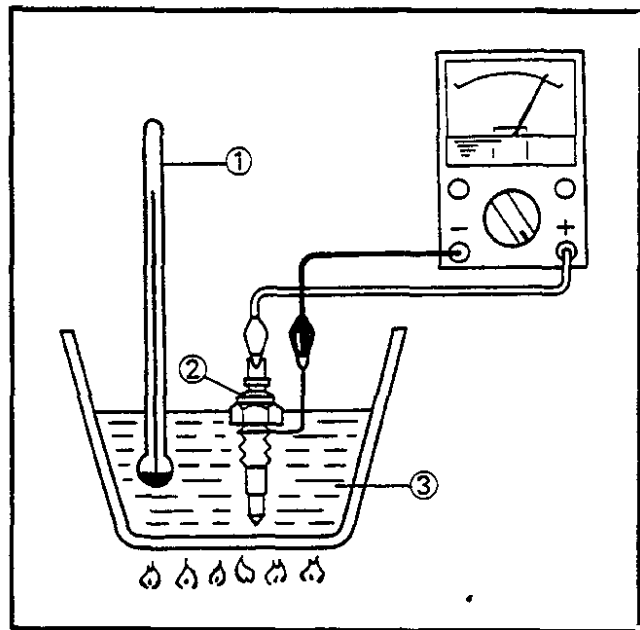

OUT OF SPECIFICATION

Thermo unit is faulty, replace it.

MEET SPECIFICATIONS

5. Voltage

- Connect the Pocket Tester (DC20V) to the temperature gauge leads.

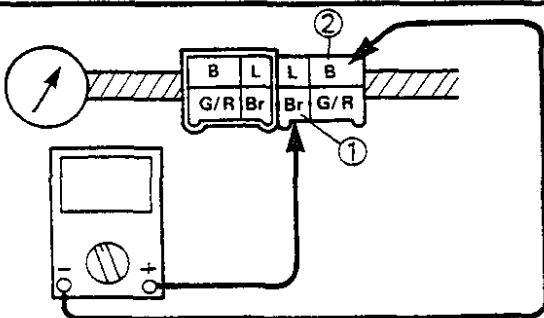

Tester (+) Lead → Brown ① Lead
Tester (-) Lead → Black ② Lead

- Turn the main switch to "ON".
- Check for voltage (12V) on the "Brown" lead at the temperature gauge connector.

OUT OF SPECIFICATION

Wiring circuit from main switch to temperature gauge connector, repair.

MEETS SPECIFICATION (12V)

*



6. Wiring connection

Check the entire cooling system for connections. Refer to the "WIRING DIAGRAM" section.

POOR CONNECTION



Correct.



CORRECT

Temperature gauge is faulty, replace it.

YAMAHA POWER VALVE SYSTEM

ELEC



YAMAHA POWER VALVE SYSTEM

CIRCUIT DIAGRAM

Below circuit diagram shows YPVS circuit.

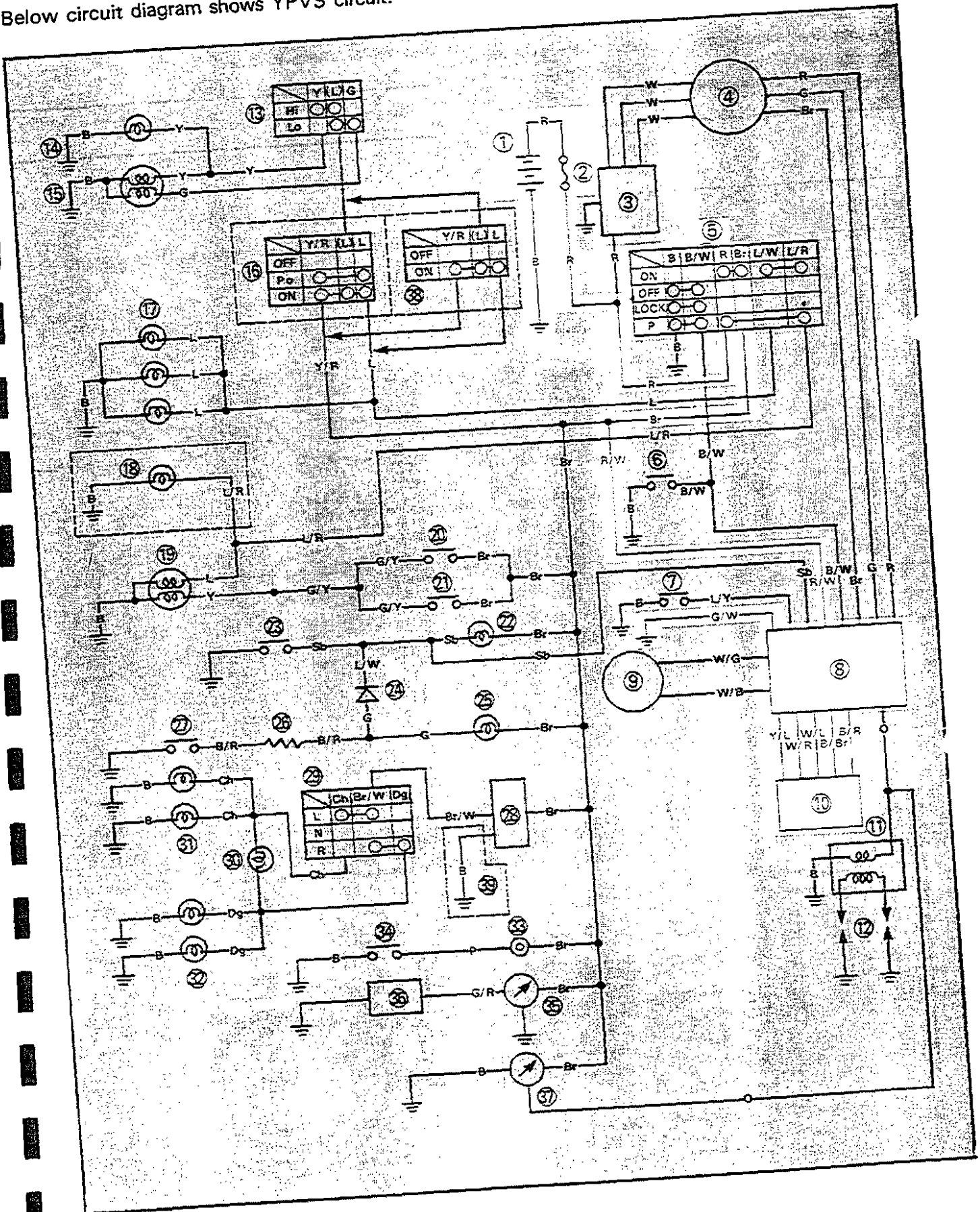

YAMAHA POWER VALVE SYSTEM

ELEC



NOTE: _____

For the color codes, see page 8-2.

- ① Battery
- ② Circuit breaker
- ⑤ Main switch
- ⑧ CDI unit/YPVS control unit
- ⑩ Servomotor

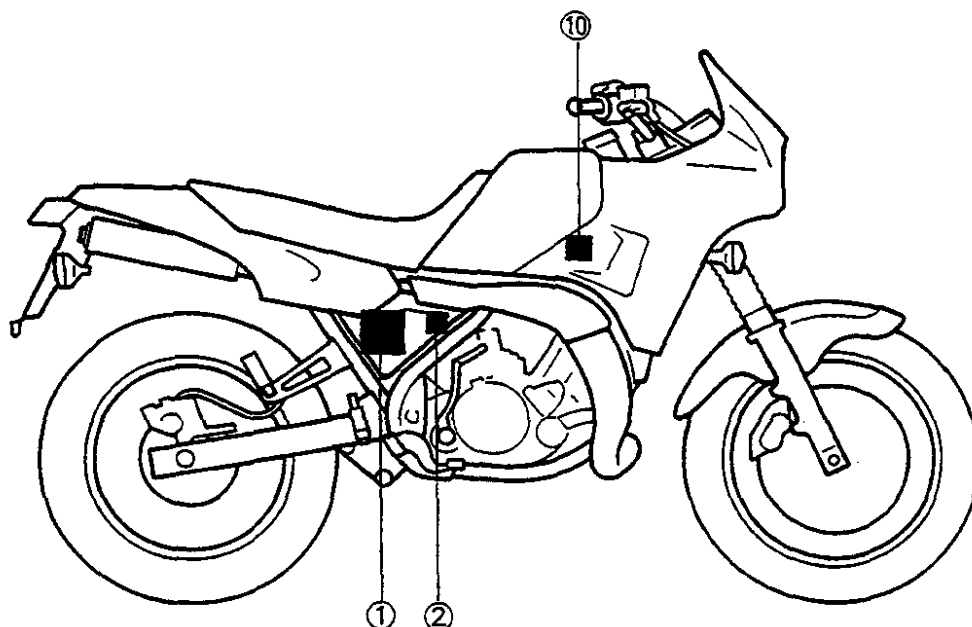
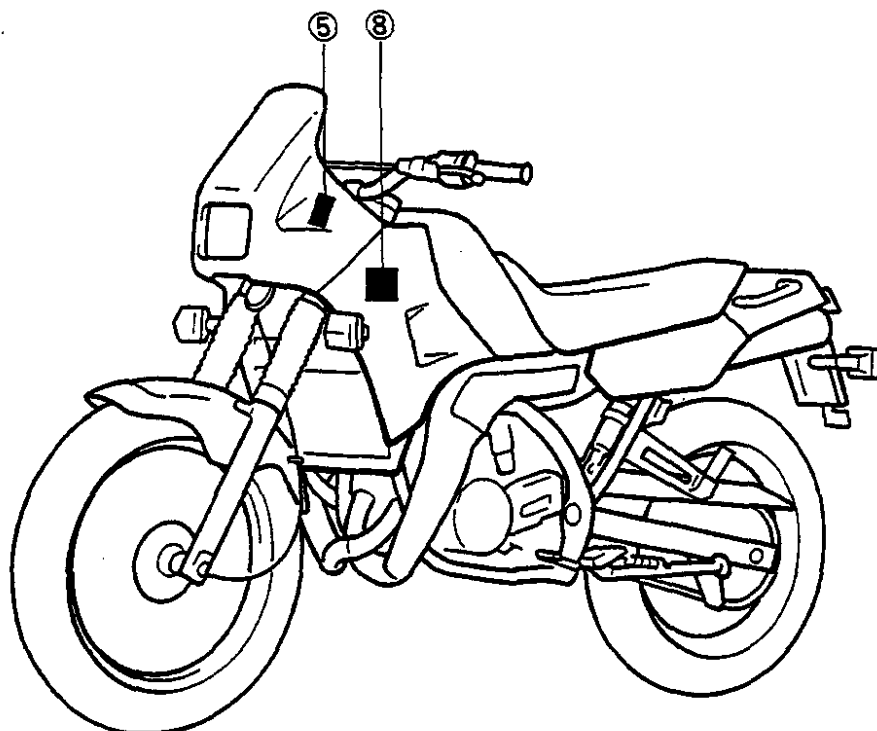



TROUBLESHOOTING

WHEN MAIN SWITCH IS TURNED TO "ON", SERVOMOTOR DOES NOT OPERATE ONE CYCLE.

Procedure (1)

Check;

1. Voltage
2. Servomotor operation
3. Servomotor resistance
(Potentiometer resistance)
4. Servomotor operation
5. Wiring connection
(Entire YPVS system)

Procedure (2)

Check;

1. Circuit breaker
2. Battery
3. Main switch
4. Wiring connection
(Entire YPVS system)

NOTE:

- Remove the following parts before troubleshooting.

1) Seat	4) Fuel tank
2) Lower cowling (Left)	5) Side cover (Right)
3) Lower cowling (Right)	
- Use the following special tool(s) in this troubleshooting.



Pocket Tester:
P/N. 90890-03112

Procedure (1)

1. Voltage

- Connect the Pocket Tester (DC20V) to the "CDI unit/YPVS control unit" ① leads.

Tester (+) Lead → Red/White ② Lead
Tester (-) Lead → Green/White ③ Lead

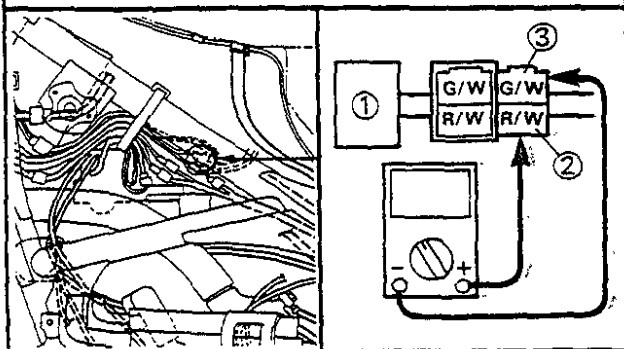

YAMAHA POWER VALVE SYSTEM



• Turn the main switch to "ON" and check for the voltage between "Green/White and Red/White".



Voltage (Green/White—Red/White):
10 ~ 16V

OUT OF SPECIFICATION

Go to the "Procedure (2)"

MEETS SPECIFICATION

2. Servomotor operation

• Disconnect the YPVS cables from the pulley.
• Turn the main switch to "ON" and check the servomotor operation.

SERVOMOTOR OPERATES.

Seized or damaged power valve at cylinder. Refer to the "INSPECTION AND REPAIR" section in the "ENGINE OVERHAUL".

SERVOMOTOR DOES NOT OPERATE.

3. Servomotor resistance (Potentiometer resistance)

• Disconnect the servomotor ① coupler.
• Connect the Pocket Tester ($\Omega \times 1k$) to the servomotor leads.

Tester (+) Lead → Yellow/Blue ② Lead
Tester (-) Lead → White/Black ③ Lead

Tester (+) Lead → Yellow/Blue ② Lead
Tester (-) Lead → White/Red ④ Lead

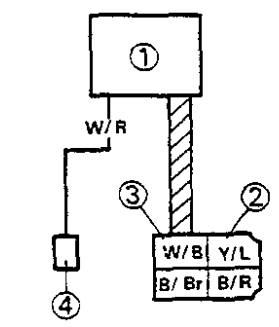
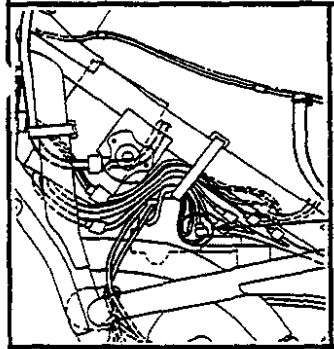

• Check the servomotor for specified resistance.



Servomotor Resistance:
5.3 ~ 9.8k Ω at 20°C (68°F)
(Yellow/Blue—White/Black)
0.6 ~ 4.5k Ω at 20°C (68°F)
(Yellow/Blue—White/Red)

OUT OF SPECIFICATION

Servomotor is faulty, replace it.

BOTH MEET SPECIFICATIONS
*



4. Servomotor operation

- Disconnect the servomotor ① coupler.
- Connect the battery leads to the servomotor leads.

Battery Positive Lead → Black/Brown ② Lead
Battery Negative Lead → Black/Red ③ Lead

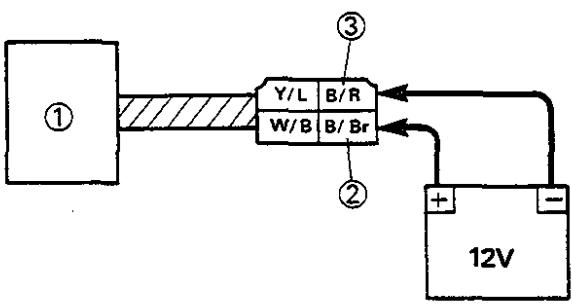

CAUTION: _____
 This test should be performed within a few seconds to prevent further damage.

SERVOMOTOR DOES NOT OPERATE.

Servomotor is faulty, replace it.

SERVOMOTOR OPERATES.

5. Wiring connection

Check the entire YPVS system for connection. Refer to the "WIRING DIAGRAM" section.

POOR CONNECTION

Correct.

CORRECT

CDI unit/YPVS control unit is faulty, replace it.



Procedure (2)

1. Circuit breaker

- Disconnect the circuit breaker leads from the wireharness.
- Connect the Pocket Tester ($\Omega \times 1$) to the circuit breaker leads.
- Push in the breaker knob and check the circuit breaker for continuity.

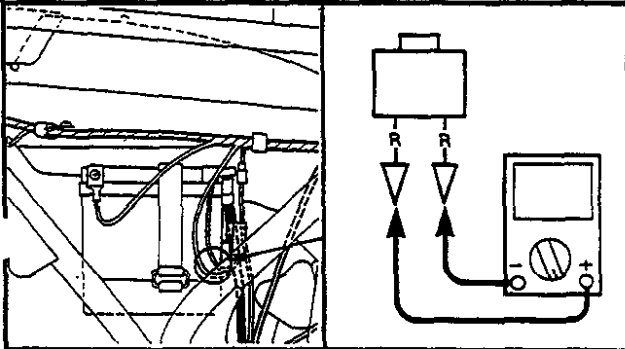

NOCONTINUITY

Circuit breaker is faulty, replace it.

CONTINUITY

2. Battery

Check the battery condition. Refer to the "BATTERY INSPECTION" section in the CHAPTER 3.

Specific Gravity:
1.280 at 20°C (68°F)

INCORRECT

- Refill battery fluid.
- Clean battery terminals.
- Recharge or replace battery.

CORRECT

3. Main switch

- Disconnect the main switch coupler from the wireharness.
- Check the switch component for the continuity between "Red ① and Brown ②". Refer to the "CHECKING OF SWITCHES" section.

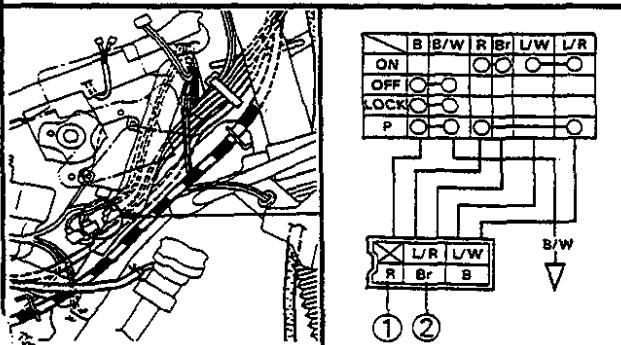

INCORRECT

Main switch is faulty, replace it.

CORRECT

*



4. Wiring connection

Check the entire YPVS system for connection.
Refer to the "WIRING DIAGRAM" section.

POOR CONNECTION

Correct.

CORRECT

Go to "Procedure (1)".

STARTING FAILURE/HARD STARTING



TROUBLESHOOTING

NOTE:

The following troubleshooting does not cover all the possible causes of trouble. It should be helpful, however, as a guide to troubleshooting. Refer to the relative procedure in this manual for inspection, adjustment and replacement of parts.

STARTING FAILURE/HARD STARTING

FUEL SYSTEM	PROBABLE CAUSE
Fuel tank	<ul style="list-style-type: none">• Empty• Clogged fuel filter• Clogged fuel breather hose• Deteriorated fuel or fuel containing water or foreign material
Fuel cock	<ul style="list-style-type: none">• Clogged fuel hose• Clogged or damaged vacuum hose
Carburetor	<ul style="list-style-type: none">• Deteriorated fuel, fuel containing water or foreign material• Clogged pilot jet• Clogged pilot air passage• Sucked-in air• Deformed float• Groove-worn needle valve• Improperly sealed valve seat• Improperly adjusted fuel level• Improperly set pilot jet• Clogged starter jet• Starter plunger malfunction• Improperly adjusted starter cable
Air cleaner	<ul style="list-style-type: none">• Clogged air filter

STARTING FAILURE/HARD STARTING



ELECTRICAL SYSTEM

PROBABLE CAUSE

Spark plug	<ul style="list-style-type: none">• Improper plug gap• Worn electrodes• Wire between terminals broken• Improper heat range• Faulty spark plug cap
Ignition coil	<ul style="list-style-type: none">• Broken or shorted primary/secondary• Faulty spark plug lead• Broken body
CDI unit system	<ul style="list-style-type: none">• Faulty CDI unit• Faulty source coil• Faulty pick-up coil• Broken woodruff key
Switches and wiring	<ul style="list-style-type: none">• Faulty main switch• Faulty engine stop switch• Broken or shorted wiring• Faulty neutral switch• Faulty sidestand switch• Faulty Ignition control unit

STARTING FAILURE/HARD STARTING/POOR IDLE SPEED PERFORMANCE

TRBL	SHTG	?
-------------	-------------	----------

COMPRESSION SYSTEM

PROBABLE CAUSE

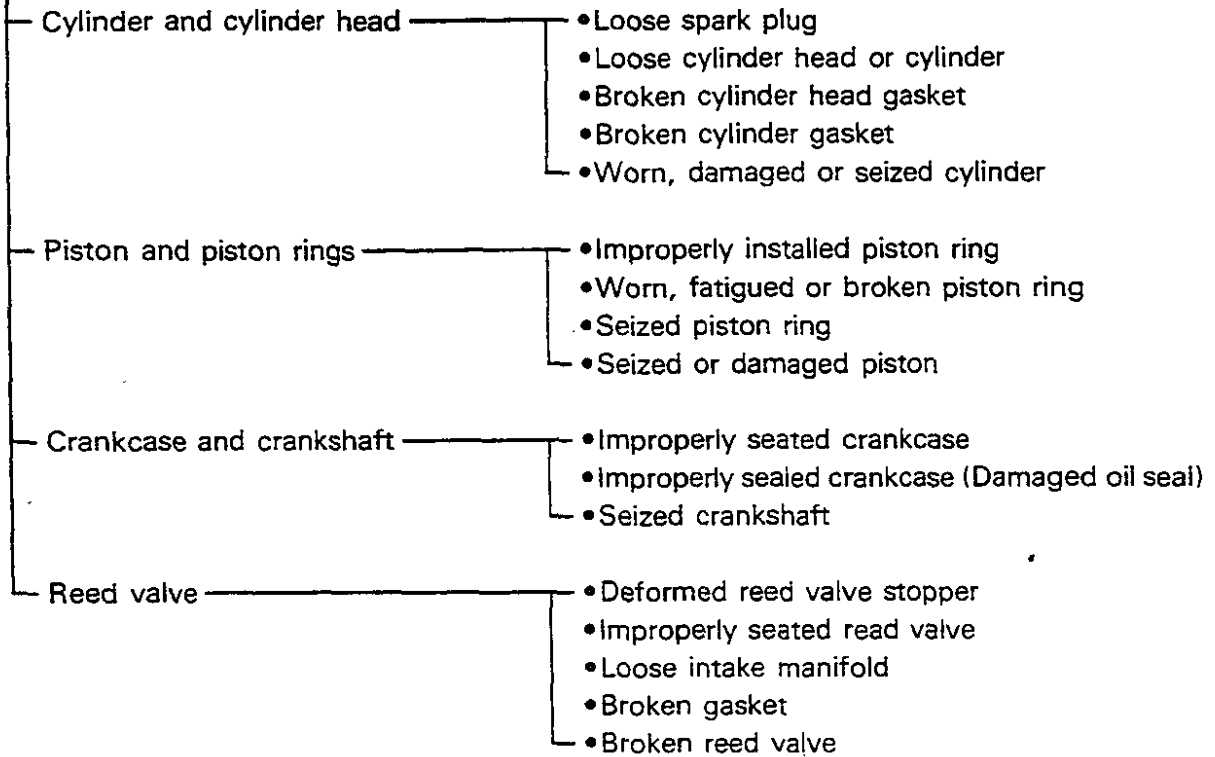

POOR IDLE SPEED PERFORMANCE

POOR IDLE SPEED PERFORMANCE

PROBABLE CAUSE

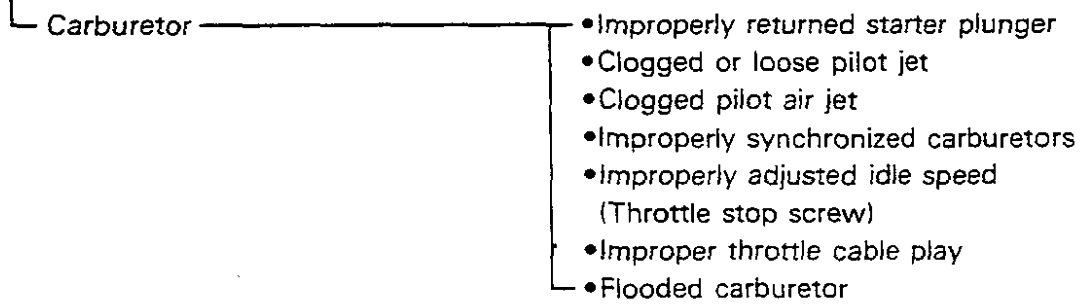

POOR MEDIUM AND HIGH SPEED PERFORMANCE



POOR MEDIUM AND HIGH SPEED PERFORMANCE

FUEL SYSTEM

PROBABLE CAUSE

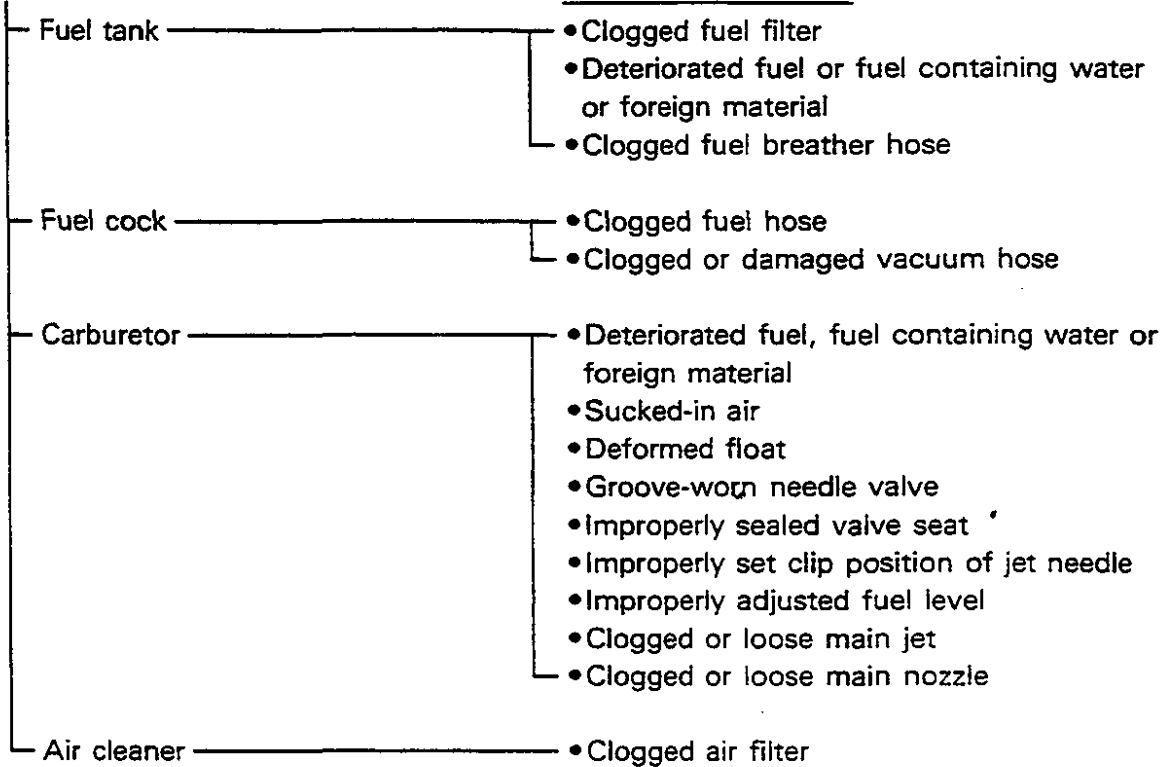

ELECTRICAL SYSTEM

PROBABLE CAUSE

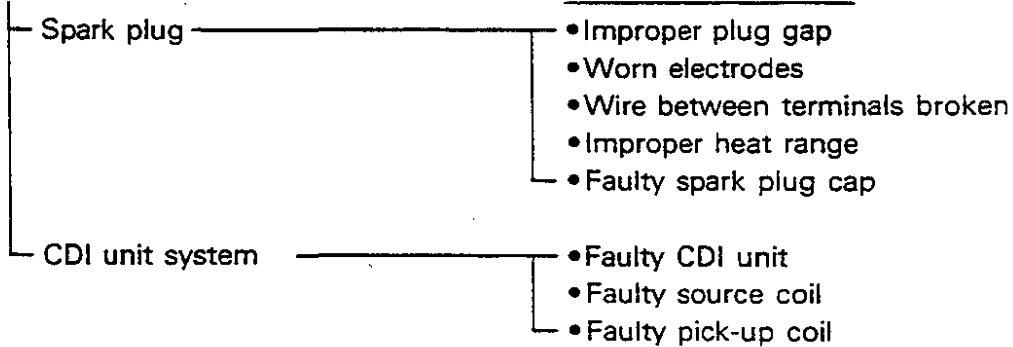

POOR MEDIUM AND HIGH SPEED PERFORMANCE



COMPRESSION SYSTEM

PROBABLE CAUSE

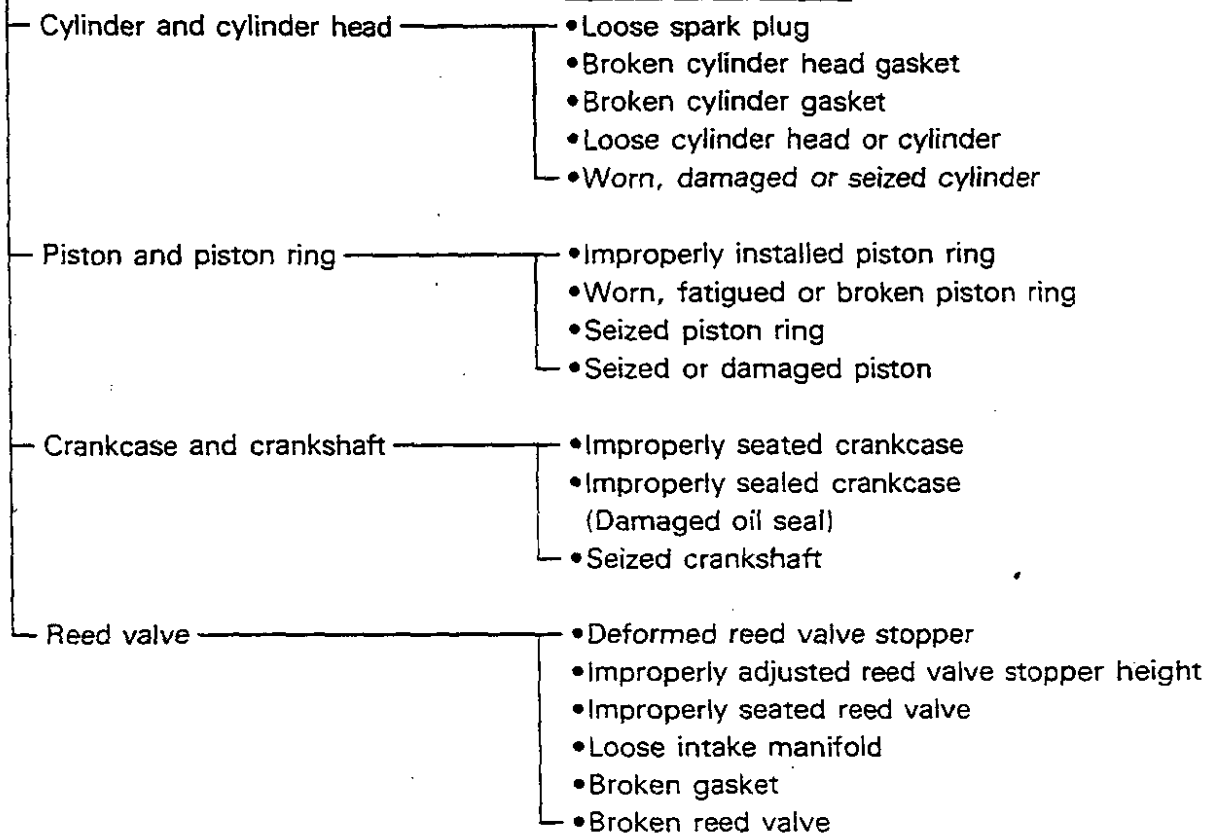

YPVS

PROBABLE CAUSE

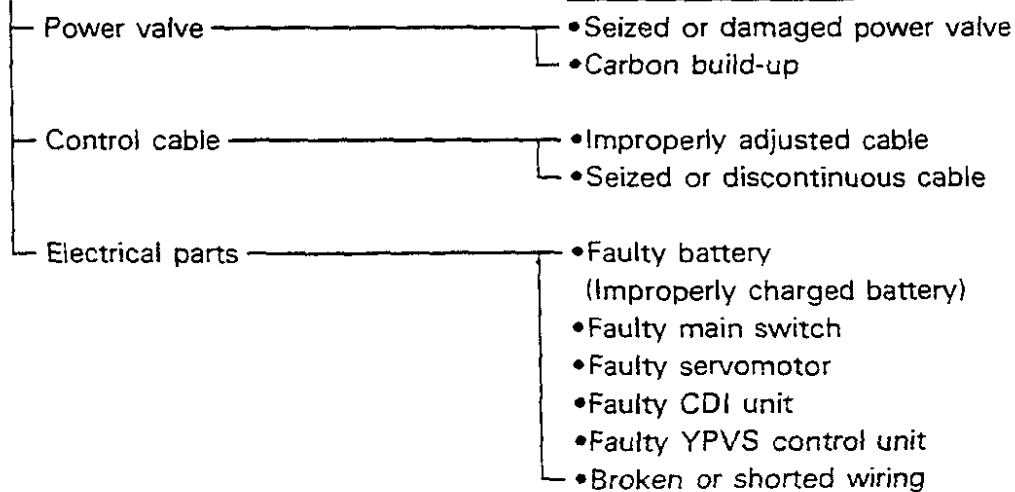

FAULTY GEAR SHIFTING



FAULTY GEAR SHIFTING

HARD SHIFTING

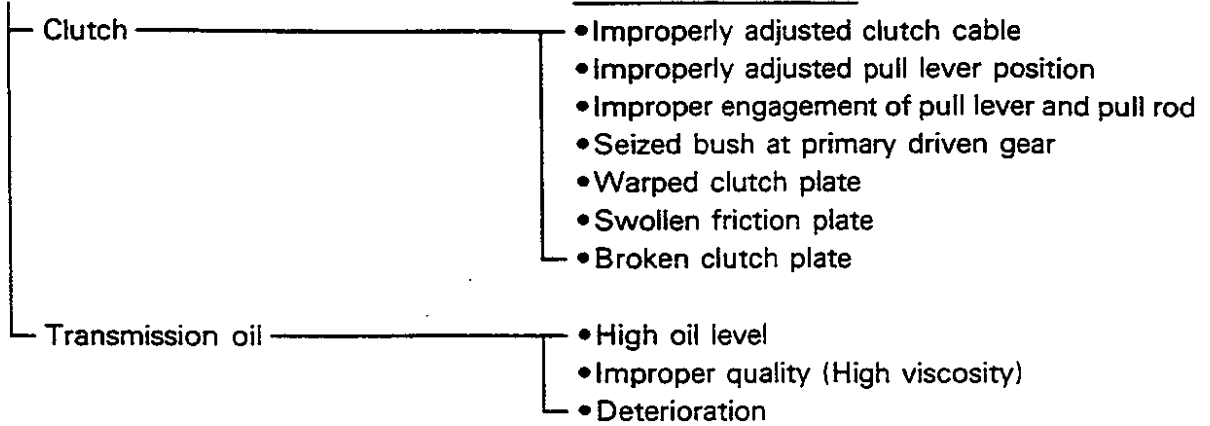

CHANGE PEDAL DOES NOT MOVE

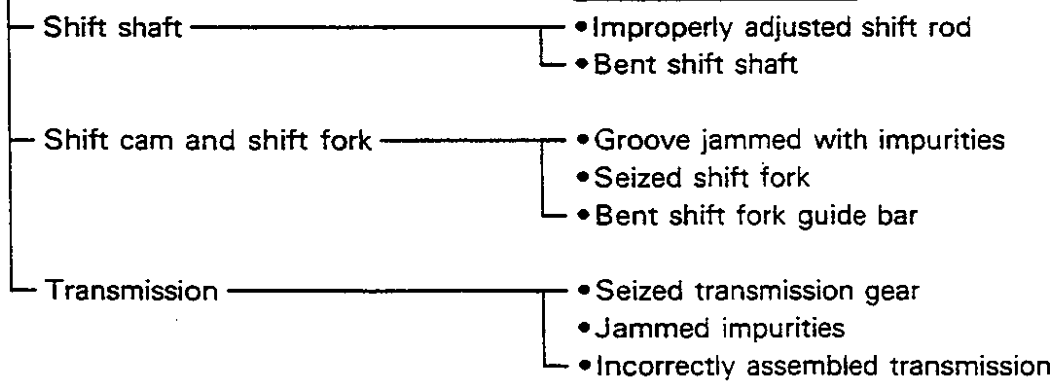

JUMP-OUT GEAR

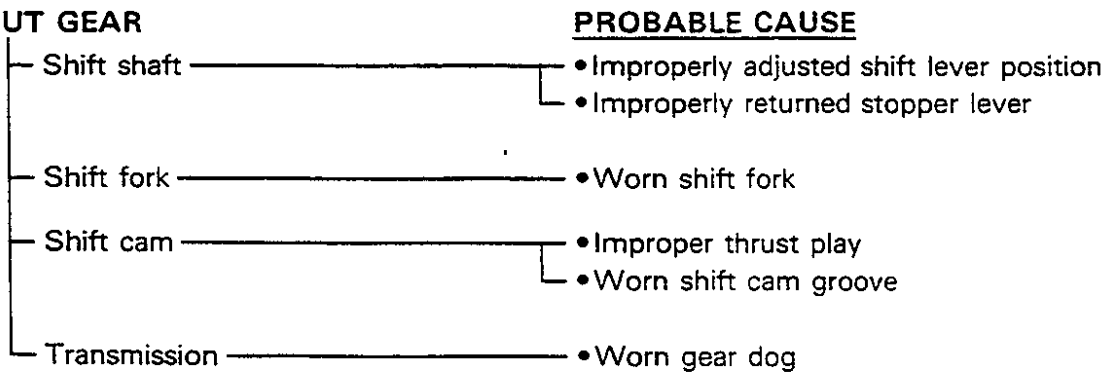

CLUTCH SLIPPING/DRAGGING

TRBL SHTG	?
--------------	---

CLUTCH SLIPPING/DRAGGING

CLUTCH SLIPPING

PROBABLE CAUSE

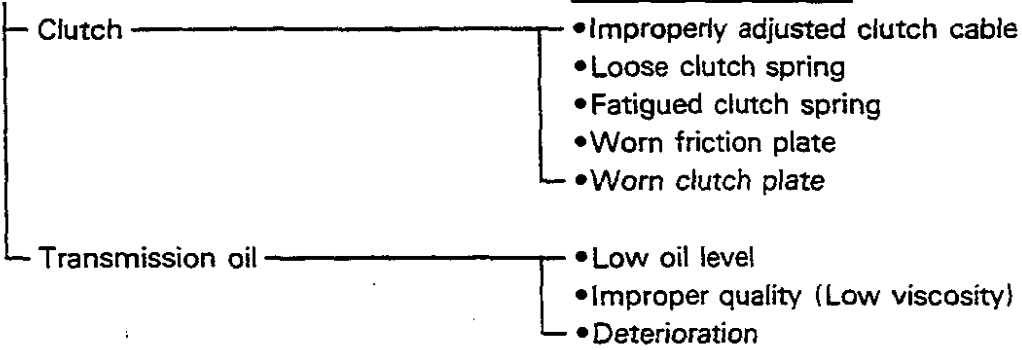

CLUTCH DRAGGING

PROBABLE CAUSE

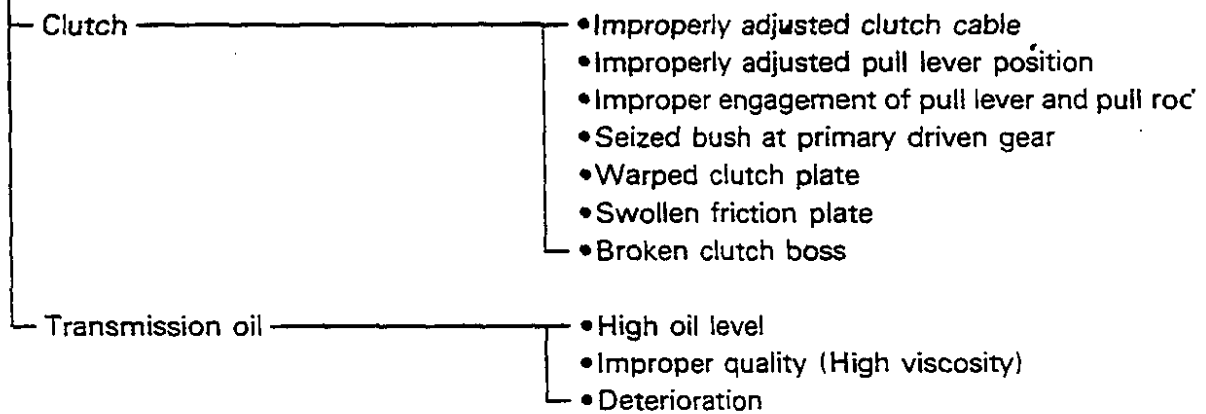

IMPROPER KICKING



IMPROPER KICKING

SLIPPING

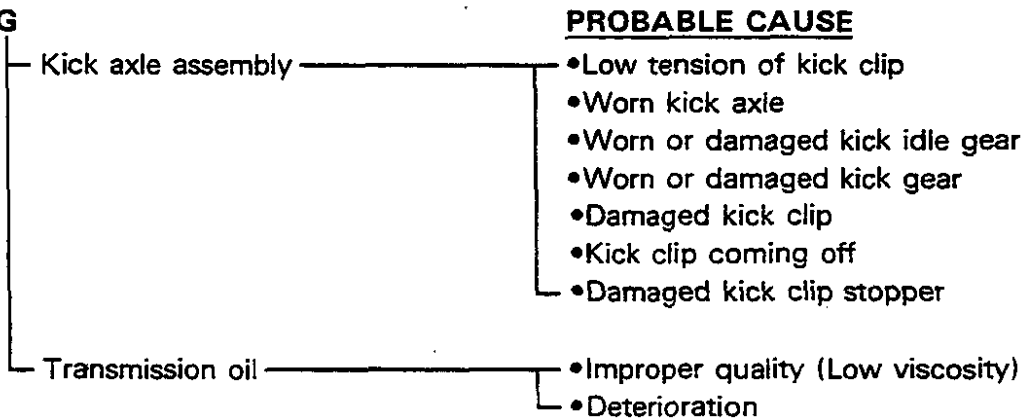

HARD KICKING

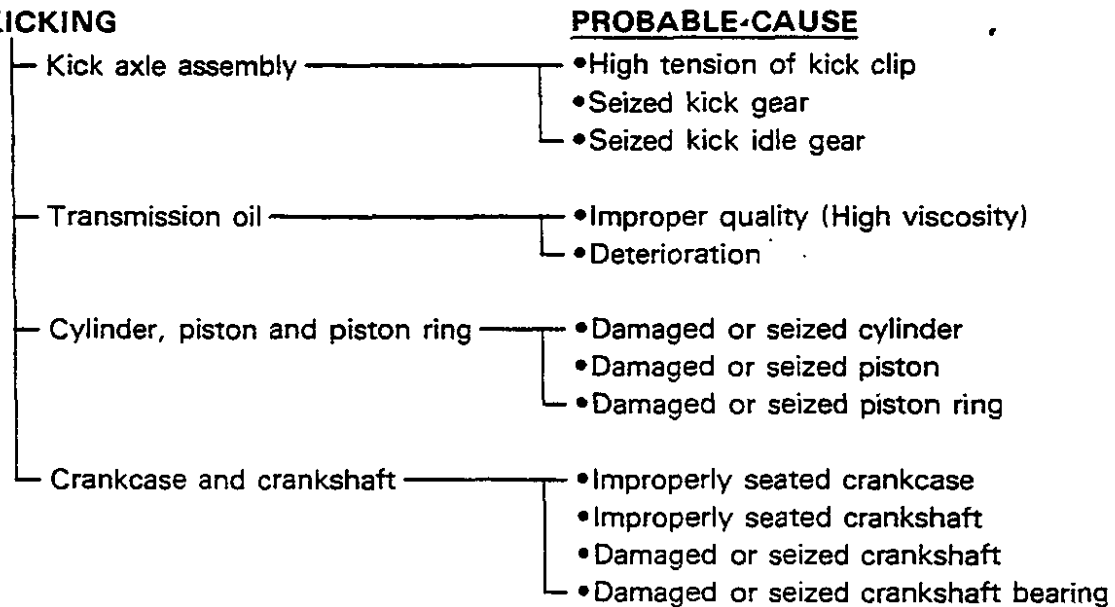

KICK CRANK NOT RETURNING

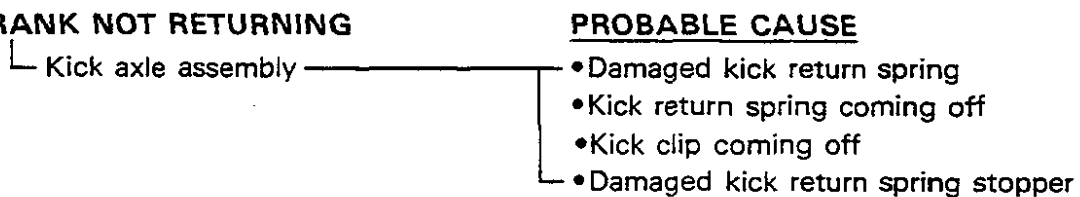

FAULTY BRAKE/FRONT FORK OIL LEAKAGE AND FRONT FORK MALFUNCTION



FAULTY BRAKE

POOR BRAKING EFFECT

PROBABLE CAUSE

- Worn brake pad
- Worn brake disc
- Air in brake fluid
- Leaking brake fluid
- Faulty cylinder kit cup
- Faulty caliper kit seal
- Loose union bolt
- Broken brake hose
- Oily or greasy brake disc
- Oily or greasy brake pad
- Improper brake fluid level

FRONT FORK OIL LEAKAGE AND FRONT FORK MALFUNCTION

OIL LEAKAGE

PROBABLE CAUSE

- Bent, damaged or rusty inner tube
- Damaged or cracked outer tube
- Damaged oil seal lip
- Improperly installed oil seal
- Improper oil level (too much)
- Loose damper rod holding bolt
- Broken cap bolt O-ring
- Loose drain bolt
- Damaged drain bolt gasket

MALFUNCTION

PROBABLE CAUSE

- Bent, deformed or damaged inner tube
- Bent or deformed outer tube
- Damaged fork spring
- Worn or damaged slide metal
- Bent or damaged damper rod
- Improper oil viscosity
- Improper oil level

INSTABLE HANDLING



INSTABLE HANDLING

INSTABLE HANDLING

PROBABLE CAUSE

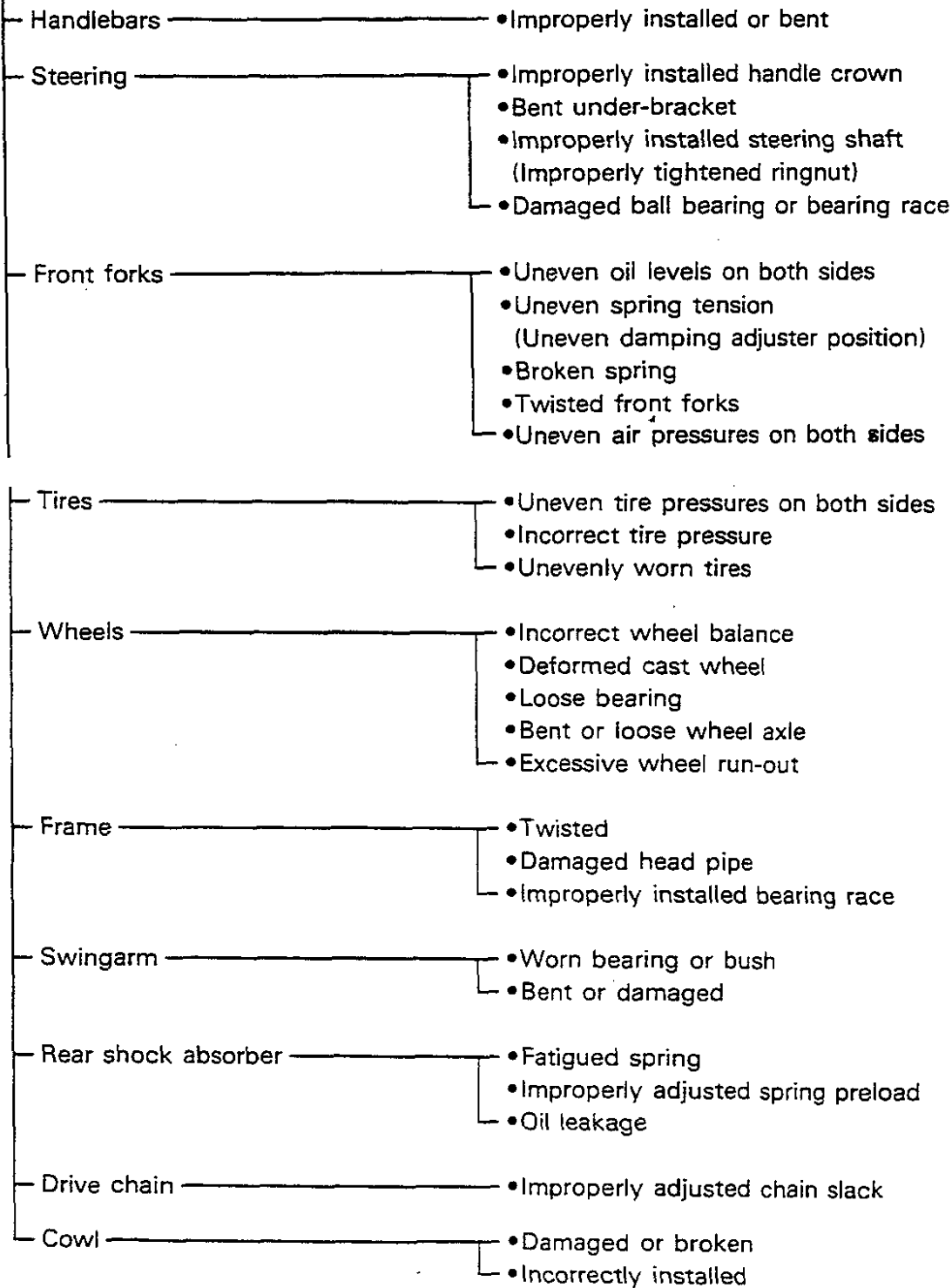

FAULTY SIGNAL AND LIGHTING SYSTEM

TRBL SHTG	?
--------------	---

FAULTY SIGNAL AND LIGHTING SYSTEM

HEADLIGHT DARK

PROBABLE CAUSE

- Improper bulb
- Too many electric accessories
- Hard charging (Broken charging coil and/or faulty rectifier/regulator)
- Incorrect connection
- Improperly grounded
- Poor contacts (main or light switch)
- Bulb life expired

BULB BURNT OUT

PROBABLE CAUSE

- Improper bulb
- Faulty battery
- Faulty rectifier/regulator
- Improperly grounded
- Faulty main and/or light switch
- Bulb life expired

FLASHER DOES NOT LIGHT

PROBABLE CAUSE

- Improperly grounded
- Discharged battery
- Faulty flasher switch
- Faulty flasher relay
- Broken wireharness
- Loosely connected coupler
- Bulb burnt out

FLASHER KEEPS ON

PROBABLE CAUSE

- Faulty flasher relay
- Insufficient battery capacity (nearly discharged)
- Bulb burnt out

FAULTY SIGNAL AND LIGHTING SYSTEM/ FAULTY YPVS

TRBL
SHTG

?

FLASHER WINKS SLOWER

PROBABLE CAUSE

- Faulty flasher relay
- Insufficient battery capacity (nearly discharged)
- Improper bulb
- Faulty main and/or "TURN" switch

FLASHER WINKS QUICKER

PROBABLE CAUSE

- Improper bulb
- Faulty flasher relay

HORN IS INOPERATIVE

PROBABLE CAUSE

- Faulty battery
- Faulty main and/or horn switch
- Improperly adjusted horn
- Faulty horn
- Broken wireharnes

FAULTY YPVS

FAULTY YPVS

PROBABLE CAUSE

- Power valve
 - Seized or damaged power valve
 - Carbon build-up
- Control cable
 - Improperly adjusted cable
 - Seized or discontinuous cable
- Electrical parts
 - Insufficient battery capacity (Improperly charged battery)
 - Faulty main switch
 - Faulty servomotor
 - Faulty CDI unit
 - Faulty YPVS control unit
 - Broken or shorted wiring

OVERHEATING OR OVER-COOLING

TRBL
SHTG

?

OVERHEATING OR OVER-COOLING

OVERHEATING

PROBABLE CAUSE

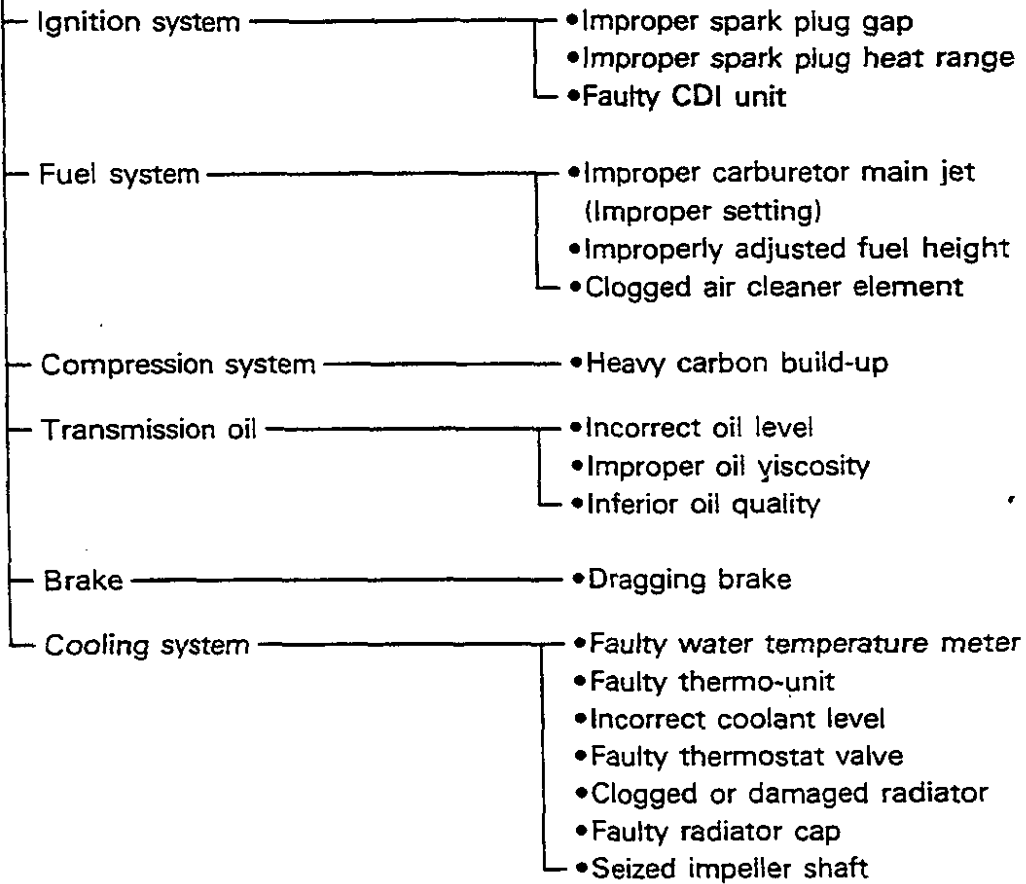

OVER-COOLING

PROBABLE CAUSE

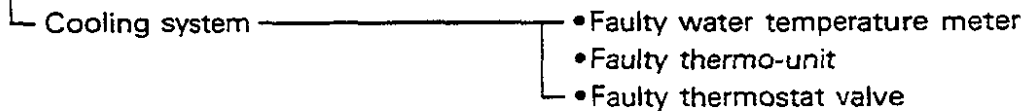

C-9

- ① Main switch
- ② YPVS servo n
- ③ CDI unit (Digital)
- ④ CDI magneto
- ⑤ "NEUTRAL" switch
- ⑥ Meter light
- ⑦ Tachometer
- ⑧ Flasher relay
- ⑨ Rear flasher light (R)
- ⑩ Tail/Brake light
- ⑪ Rear flasher light (L)
- ⑫ Circuit breaker
- ⑬ Battery
- ⑭ Rear brake switch
- ⑮ Diode
- ⑯ Oil level gauge
- ⑰ Front brake switch
- ⑱ Rectifier/Regulator
- ⑲ Earth
- ⑳ "SIDE STAND" switch
- ㉑ Horn
- ㉒ Thermo switch
- ㉓ Ignition coil
- ㉔ "LIGHTS" switch
- ㉕ "LIGHTS" (Dimmer) switch
- ㉖ "HORN" switch
- ㉗ Front flasher light (L)
- ㉘ Temperature gauge
- ㉙ "TURN" indicator light
- ㉚ "OIL LEVEL" indicator light
- ㉛ "NEUTRAL" indicator light
- ㉜ "HIGH BEAM" indicator light
- ㉝ "ENGINE STOP" switch
- ㉞ Front flasher light (R)
- ㉟ Auxiliary light
- ㊱ Headlight

COLOR CODE

B	Black
Br	Brown
Ch	Chocolate
Dg	Dark green
G	Green
L	Blue
O	Orange
P	Pink
R	Red
Sb	Sky blue
W	White
Y	Yellow
B/Br	Black/Brown
B/W	Black/White
Br/W	Brown/White
G/R	Green/Red
G/W	Green/White
G/Y	Green/Yellow
L/R	Blue/Red
L/W	Blue/White
L/Y	Blue/Yellow
R/W	Red/White
W/B	White/Black
W/G	White/Green
W/L	White/Blue
W/R	White/Red
Y/L	Yellow/Blue

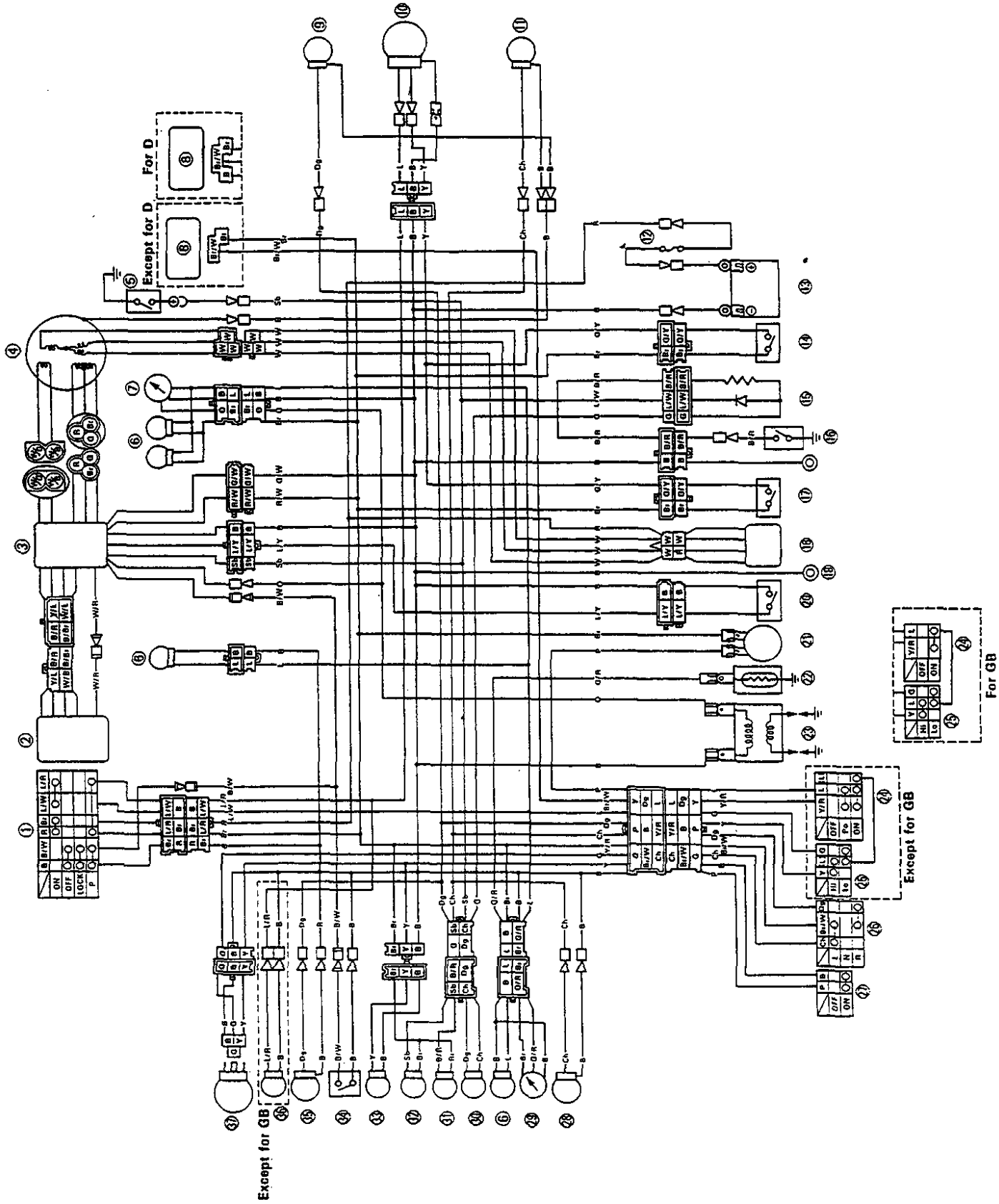



YAMAHA MOTOR CO., LTD.

DAIWA MOTOR

PRINTED IN JAPAN