

# **YAMAHA**

**SINGLE ENDURO  
RT1-B & RT1-MX  
360  
RIDER'S MANUAL**

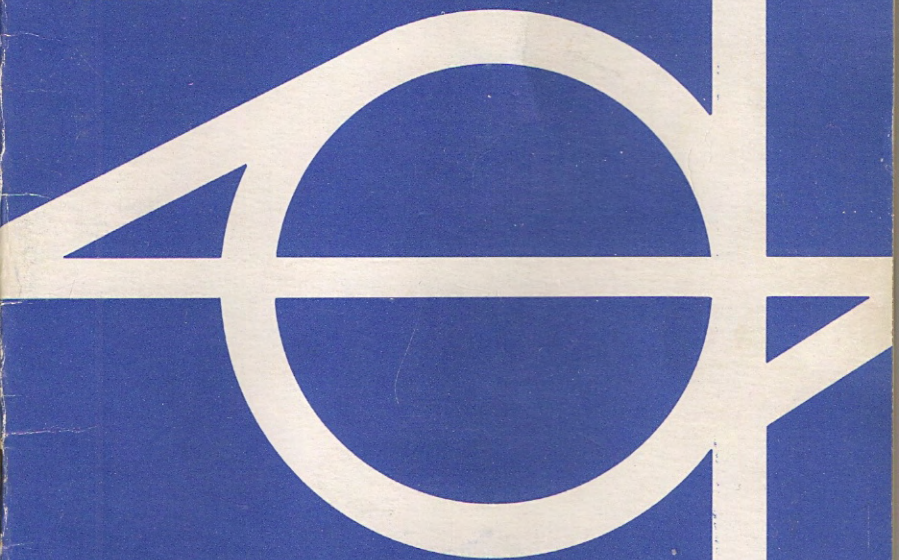

275-28199-10

*Congratulations! You are now the owner of a new Yamaha SINGLE ENDURO 360 RT1-B (RT1-MX). The RT1 is a high performance motorcycle manufactured by the leading manufacturer of motorcycles in Japan.*

*The RT1-B & RT1-MX, the newest and top of the Yamaha ENDURO line is designed for competition and high-speed road use. It features a rugged, powerful, 2-stroke single cylinder engine, and Autolube, the revolutionary lubricating system developed by Yamaha Technical Research Laboratory and proven in all Yamaha models.*

*This manual explains some steps necessary for operating and caring for your new motorcycle. Please read it carefully to become thoroughly familiar with all the features and advantages built into your RT1-B (RT1-MX).*



## CONTENTS

I.	Features and Specifications .....	3
1.	Features .....	3
2.	Specifications .....	5
3.	Performance Curves .....	8
II.	Yamaha Autolube .....	10
III.	Nomenclature .....	11
IV.	Basic Instructions .....	17
1.	Gasoline and Oil .....	17
2.	Familiarization of Equipment .....	17
3.	Pre-operation Check .....	23
4.	Operation .....	24
5.	Break-in Procedure .....	27
6.	Cruising .....	27
V.	Service Tools .....	28
VI.	Inspection and Service .....	29
1.	Periodic Inspection Guide .....	29
2.	Inspection and Adjustment .....	30
VII.	Conversion of the Yamaha RT1-B for racing .....	45
1.	Engine Tune-up .....	45
2.	Modification of the Chassis .....	46
3.	Service Data (Tuning parts specifications) .....	48
4.	Change in Specifications .....	50
5.	Miscellaneous Notes .....	51



# **I. Features and Specifications**

## **1. Features**

### **( 1 ) High-performance Single Cylinder Engine**

The Yamaha Enduro 360 RT1-B utilizes a powerful two-stroke 360 cc engine. The new five-port cylinder, which is another Yamaha technical development, greatly improves engine efficiency and is responsible for high power output throughout a broad R.P.M. range.

### **( 2 ) Highly-dependable Yamaha Autolube**

Yamaha Autolube provides superior engine lubrication that extends the service life of the engine.

### **( 3 ) Easy Starting**

The engine can be started by simply disengaging the clutch and kicking the kick pedal without shifting gears back to neutral. This is a valuable convenience to the rider.

### **( 4 ) Powerful Brakes**

Patented waterproof, dustproof brake drums provide safe, fade-free braking on wet or dusty roads.

### **( 5 ) Adjustable Rear Cushion**

The rear cushions are adjustable to five positions. The rider can adjust spring tension to compensate for varying weights, speeds, and road conditions.

### **( 6 ) Front Fork Design**

The Yamaha Enduro 360 RT1-B employs a front fork design well known for its strength and superior handling characteristics. Its use assures the rider the ultimate suspension for even the roughest terrain.

The RT1MX also employs an oil damper for better driving stability.

### **( 7 ) Speedometer and Tachometer**

A speedometer and tachometer are standard equipment for the RT1-B. The individual units are separately mounted for maximum visibility. An additional feature of the speedometer is an odometer which can be reset by tenths to zero for trip or enduro purposes.



**( 8 ) Tires**

The Yamaha RT1-B is fitted with tires having a universal type tread pattern as standard equipment. This particular tread is one of the most versatile available. It gives maximum trail traction and yet is compatible with road usage.

The RT1-MX is fitted with tires having a knobby type tread pattern.

**( 9 ) Carburetor Starter Feature**

Yamaha's starter feature is already well-known for providing easy starting. Equipped with this unique carburetor, the Yamaha RT1-B is quick starting under all conditions.

**(10) G.Y.T. (Genuine Yamaha Tuning) Kit**

The RT1-MX is furnished with a G.Y.T. kit that converts it into a fully equipped motocrosser.

## 2. Specifications

	RT1-B	RT1-MX
Dimensions:		
Overall length	82.7 in.	82.3 in.
Overall width	35.0 in.	35.0 in.
Overall height	45.7 in.	46.7 in.
Wheelbase	54.7 in.	55.1 in.
Min. ground clearance	10.0 in.	10.0 in.
Weight:		
Net	258 lbs	238 lbs
Performance:		
Max. speed	78 MPH (+)	
Fuel consumption (On paved level road)	82 mile/U.S.gal (37 mph)	
Climbing ability	35°	
Min. turning radius	78.7 in.	78.7 in.
Braking distance	49 ft (31) mph	50.5 ft (31) mph
Engine:		
Model	RT1	RT1
Type	2-stroke gasoline	2-stroke gasoline
Lubricating system	Separate lubrication (Yamaha Autolube)	Mixed Gasoline
Cylinder	Single, forward inclined, 5-port	Single, forward inclined, 5-port
Displacement	21.42cu., in. (351cc)	21.42cu., in. (351cc)
Bore X Stroke	3.150 X 2.756 in. (80 X 70mm)	3.150 X 2.756 in. (80 X 70 mm)
Compression ratio	6.3 : 1	7.5 : 1
Max. power	30 BHP/6,000 r.p.m.	36 BHP/6,500 r.p.m.
Max. torque	26 ft. lb/5,500 r.p.m.	28.7 ft lb/6,500 r.p.m.

Starting	Primary-coupled kick starter system	Primary-coupled kick starter system
Ignition system	Flywheel magneto	Flywheel magneto
Ignition timing	2.9 mm. B.T.D.C. (Advance open)	2.9 mm. B.T.D.C. (Advance open)
Carburetor:		
Type	VM32SH	VM34SH
M. J.	#240	#320
J. N.	6CF1-2 stages	6DH2-3 stages
Air cleaner:	Wet, foam rubber	Wet, foam rubber
Spark plug:	B-9ES	B-9EN
Chassis:		
Frame	Tubular-Double loop	Tubular-Double loop
Suspension Front	Telescopic fork	Telescopic fork
Rear	Swinging arm	Swinging arm
Transmission:		
Clutch	Wet, multiple-disk	Wet, multiple-disk
Primary reduction system	Gear	Gear
Primary reduction ratio	3.095 (65/21)	3.095 (65/21)
Gear Box:	Wide ratio	Close ratio
Gear shifting type	Constant mesh, 5-speed	Constant mesh, 5-speed
Reduction ratio 1st	2.533 (38/15)	2.250 (36/16)
2nd	1.790 (34/19)	1.650 (33/20)
3rd	1.305 (30/23)	1.260 (29/23)
4th	1.000 (26/26)	1.000 (26/26)
5th	0.767 (23/30)	0.793 (23/29)
Secondary reduction system	Chain	Chain
Secondary reduction ratio	2.600 (39/15)	2.933 (44/15)



Steering:		
Steering angle		
Caster	60° 30'	60° 30'
Trail	5.1 in.	5.39 in.
Tire size:		
Front	3.25-19-4PR	2.75-21-4PR
Rear	4.00-18-4PR	4.00-18-4PR
Lighting:		
Headlight	6V 35W/35W	
Taillight	6V 5.3W	
Stoplight	6V 17W	
Meter light	6V 3W X 2	
Battery:		
Model No.	MV1-6D	
Capacity	6V 2AH	
Dynamo model:	FZC-1A1L	FZC-1A1L
Tanks:		
Gasoline tank capacity	2.5 gal. (9.5 l)	2.5 gal. (9.5 l)
Oil tank capacity	1.7 qt. (1.6 l)	1.7 qt. (1.6 l)

### 3. Performance Curves

RT1-B ENGINE PERFORMANCE CURVES

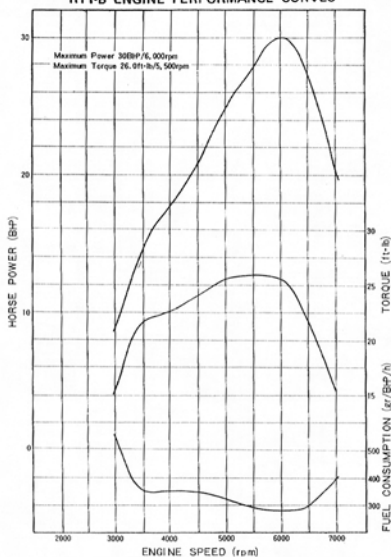

360 RT1-B DRIVING PERFORMANCE CURVES

Maximum Power 36BHP/6,000rpm  
Maximum Torque 26.0ft-lb/5,500rpm  
Primary reduction ratio 65/21 (3.095)  
Secondary reduction ratio 39/15 (2.600)  
Gear ratio 1st 38/15 5th 23/30 Tire size Rear 4.00-18-4PR  
2nd 34/15  
3rd 30/23  
4th 26/26

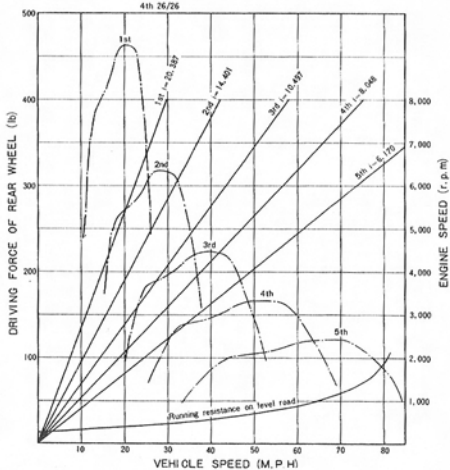

# RT1-MX ENGINE PERFORMANCE CURVES

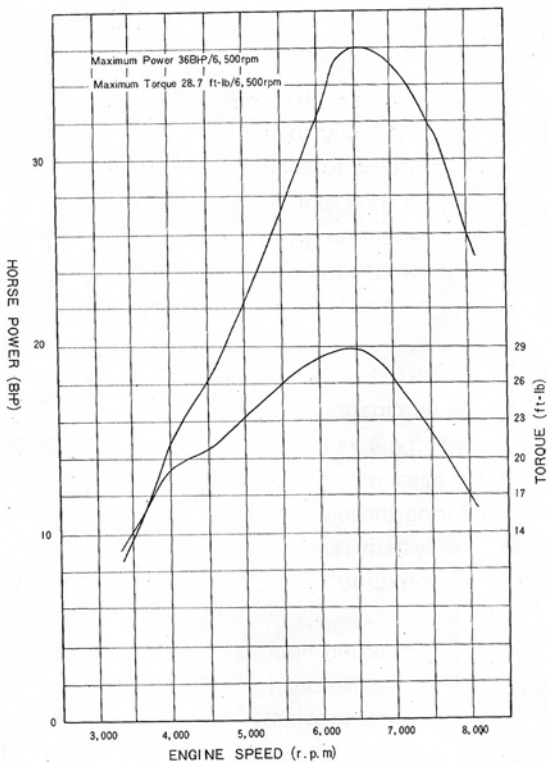



## II. Yamaha Autolube

### What is Yamaha Autolube?

Yamaha Autolube is an automatic lubrication system which obsoletes the conventional two-stroke premixing system. Oil stored in the oil tank is metered automatically to the engine, by an oil pump, with the quantity varying according to engine speed and load. The heart of the system is the compact, precision-built oil pump. Driven off the engine crankshaft through reduction gears, the varying oil needs are regulated by the pump which feeds the oil directly to the engine. Regulation is controlled through engine rpm's and throttle setting.

### Features:

Yamaha Autolube eliminates the lubrication problems peculiar to two-stroke engines with the conventional "Pre-mixing" system. Oil is never contaminated by gasoline prior to delivery to the engine, nor is it subject to de-naturing through storage in the gas tank.

#### 1. The Autolube system results in:

- a) Oil consumption up to 1/3 LESS than that of previous lubrication systems.
- b) Greatly reduced carbon build-up.
- c) Reduced exhaust emission.

#### 2. The Autolube system provides:

- a) Fresh oil supply.
- b) Complete lubrication due to large oil particles.
- c) No worries about the compatibility of oil and oil-fuel mixing ratios.

### III. Nomenclature

(RT1-B)

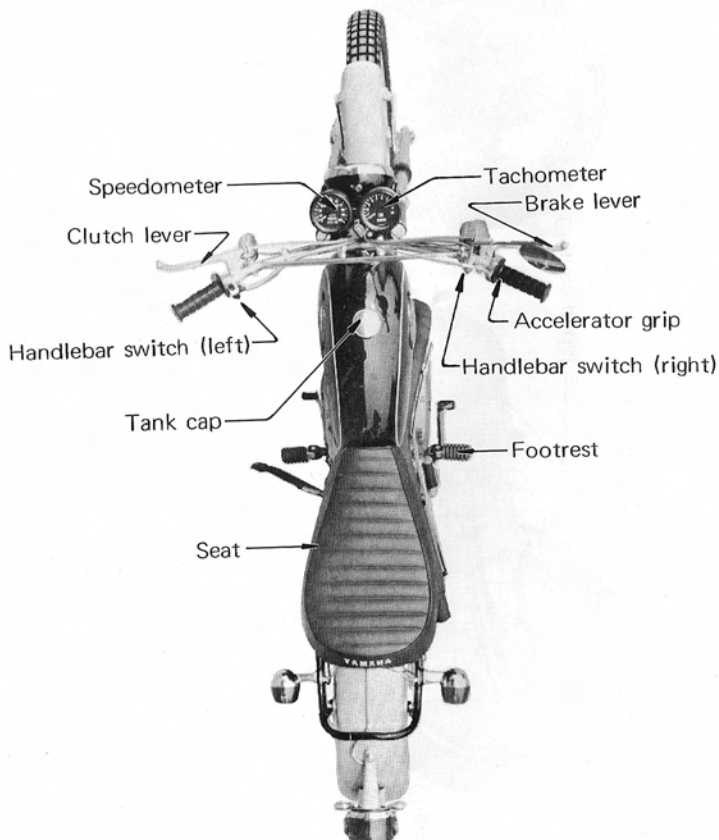

(RT1-B)

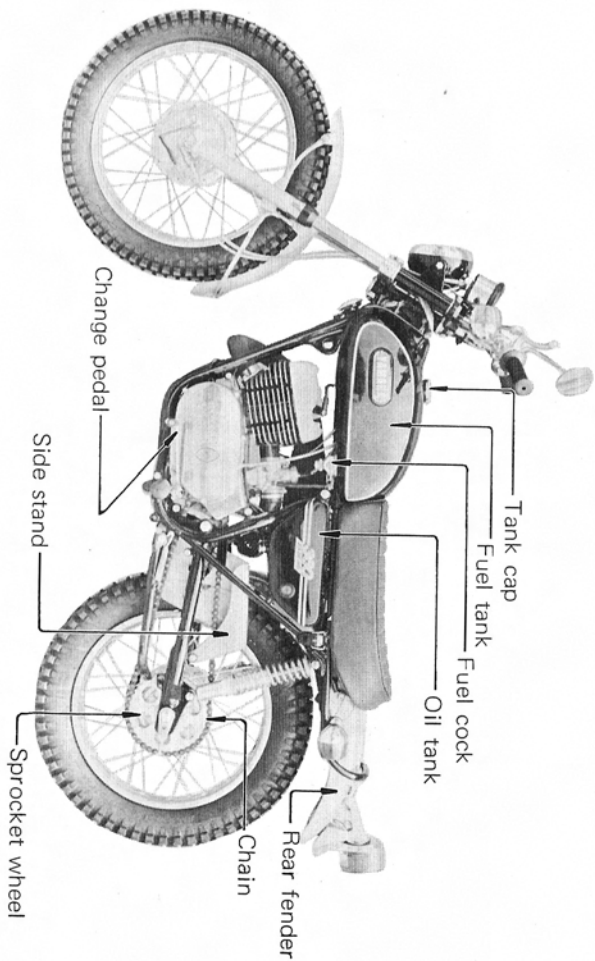



(RT1-B)

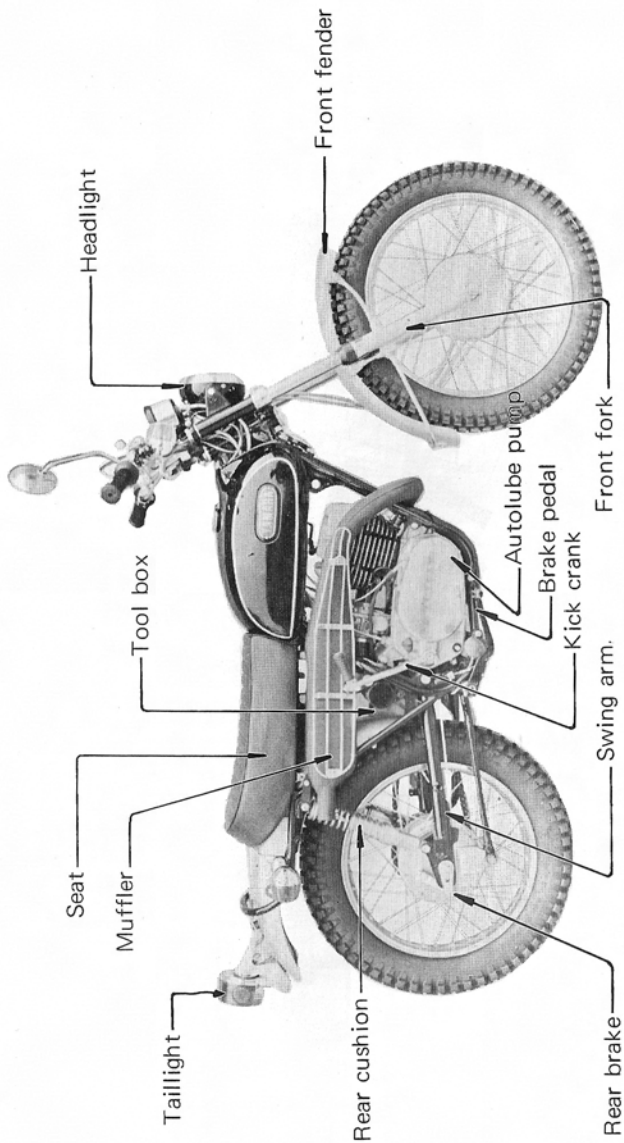

(RT1-MX)

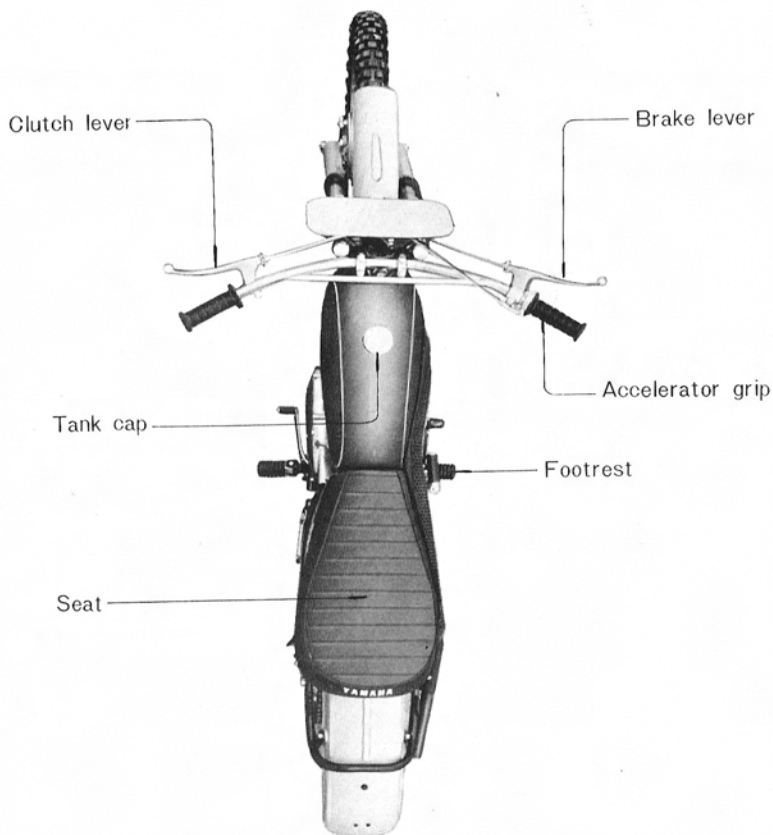

(RT1-MX)

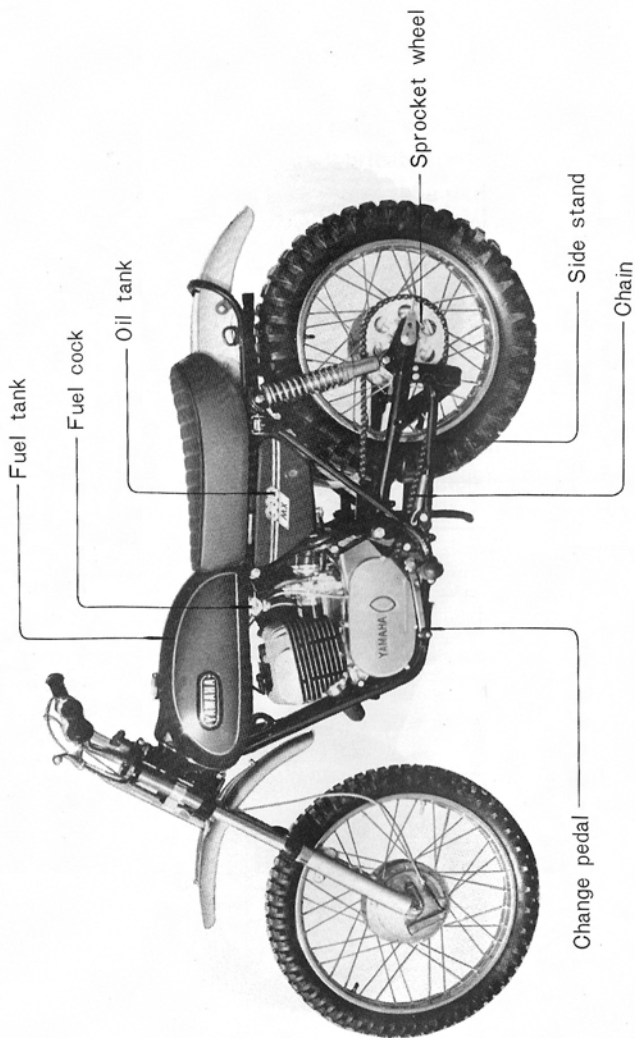

(RT1-MX)

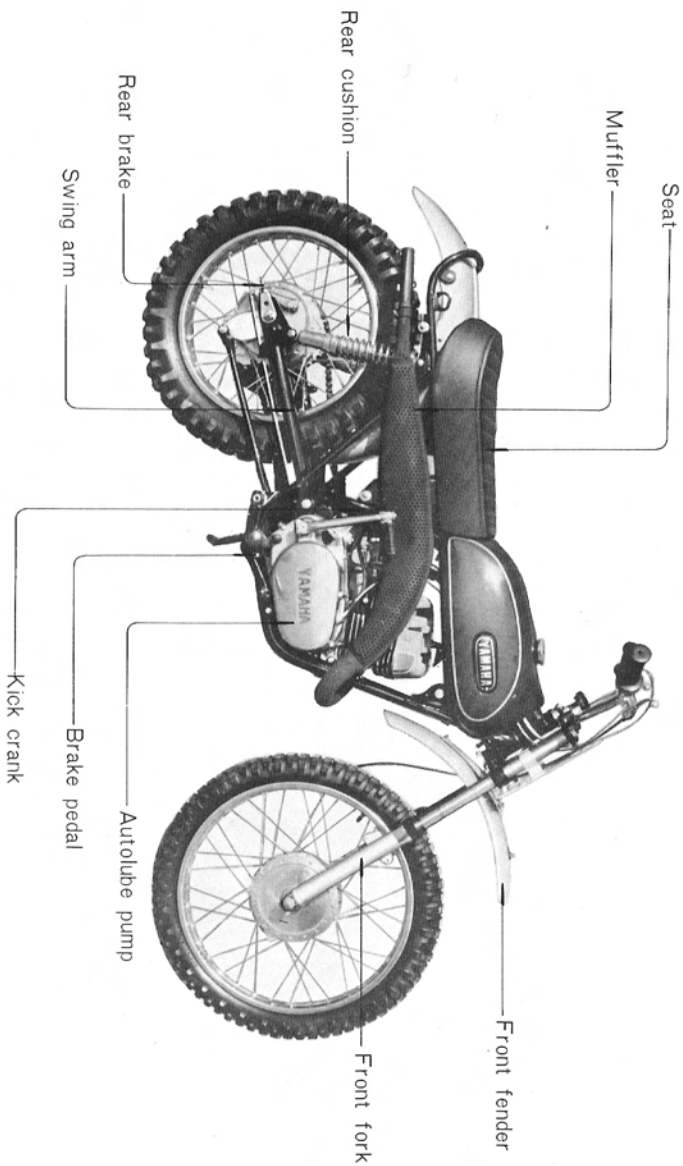

## IV. Basic Instructions

### 1. Gasoline and Oil

The Yamaha Enduro 360 RT1-B, equipped with the Yamaha Autolube system, uses straight gasoline as fuel.

Gasoline: Use gasoline of 90 octane rating or more.

Oil : Use Yamalube for engine lubrication.

Store oil in the separate oil tank located under the seat. The fuel/oil mixing ratio for RT1-MX is 15 : 1 when not using the Autolube pump. It is advisable to use high-octane gasoline (more than 100 octane) and Shell Super 2-stroke oil or racing oil of similar quality in the RT1-MX.

#### [Autolube Oil]

Yamaha Autolube Oil (YAMALUBE), refined especially for this new lubricating device, excels in lubrication, cleanliness and liquidity at low temperatures. The performance of the Autolube system depends on the oil quality. Yamaha Autolube Oil is recommended for higher performance and longer engine life.

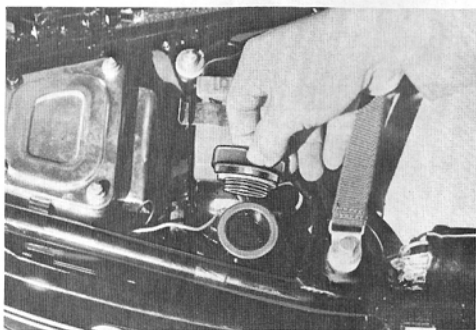

### 2. Familiarization of Equipment

#### (1) Main Switch

The main switch has three key positions, Off, Ignition, and Ignition + Lights.

The following chart shows the key positions at which the various system are switched on or off. (The circle (○) denotes "Switch on.")

	OFF	I	II	Instructions
Engine		<input type="radio"/>	<input type="radio"/>	To start the engine, kick the kick pedal
Neutral light		<input type="radio"/>	<input type="radio"/>	The change pedal is in neutral.
Meter lamp			<input type="radio"/>	
Headlight			<input type="radio"/>	
Taillight			<input type="radio"/>	
Stoplight		<input type="radio"/>	<input type="radio"/>	The brake is applied.
Horn		<input type="radio"/>	<input type="radio"/>	The horn button is depressed.
Flasher light		<input type="radio"/>	<input type="radio"/>	Turn on left handlebar switch.

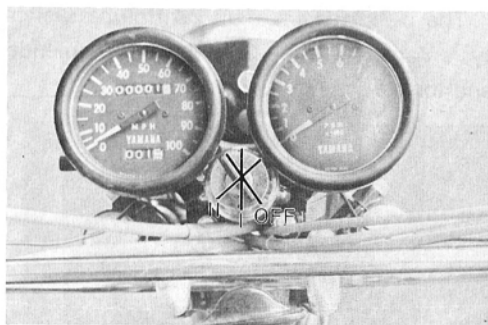

The RT1-MX is not provided with a main switch. When stopping the engine engage the clutch and depress the change pedal. Then apply the brake and slowly disengage the clutch.

**(2) Fuel Petcock**

To allow the fuel to flow to the carburetor, turn the fuel petcock lever to ON. Should you run low of fuel while driving, turn it to RESERVE. The reserve position will enable you to drive approximately 25 miles (40 km). When parking, the lever should be turned to STOP.



**(3) Left Handlebar Switches (Applicable to the RT1-B only)**

- a. To sound the horn, depress the horn button.
- b. To raise the headlight beam, pull the switch toward you. To lower the beam, push the switch toward the front.

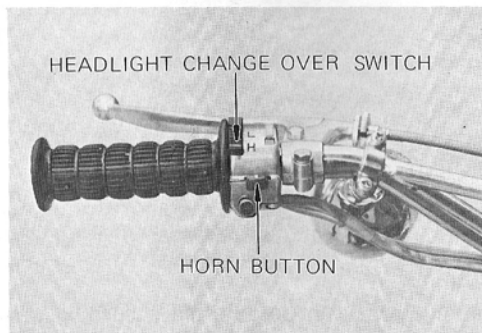



## 2. Inspection and Adjustments

The methods of inspection and adjustment are discussed below. This information will be of value in your daily inspections.

### 1) Adjusting the Brakes

#### a) Front Brake

The correct free play of the front brake lever pivot point is 0.2 ~ 0.3 in. (5 ~ 8 mm.)

To adjust, turn the cable adjusting bolt located at the lever. After adjustment, be sure to tighten the lock nut fully.

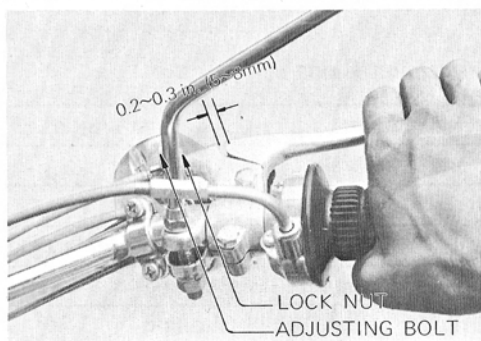

**Note:** The RT1-B is equipped with a front brake operated stoplight switch. During the above operation check the stoplight for proper operation.

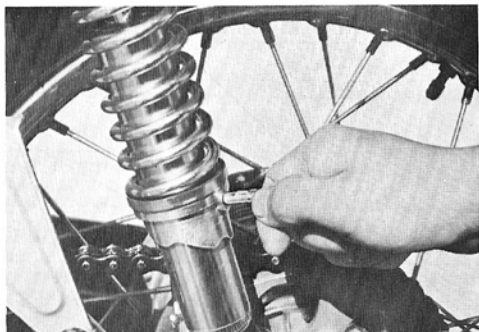

- (7) **How to Read the Tachometer (Applicable to the RT1-B only)**  
A tachometer is provided so that the rider can easily maintain engine RPM sufficient to keep the engine within the power curve. The standard Yamaha RT1-B is designed to run best in the power range between 2,000 r.p.m. and 6,000 r.p.m. Never lug your engine! It is also recommended not to use red-zone 6,500 ~ 10,000 r.p.m.

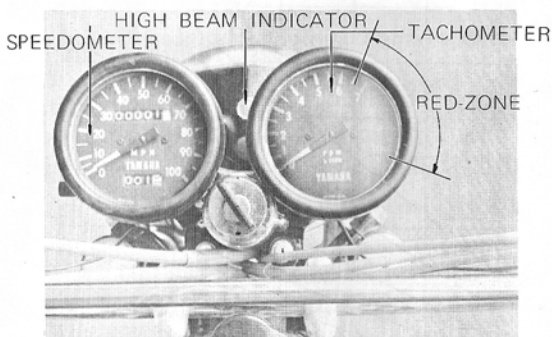

The relationship between engine RPM's and gears is shown in the diagram on the next page.

### RT1-B

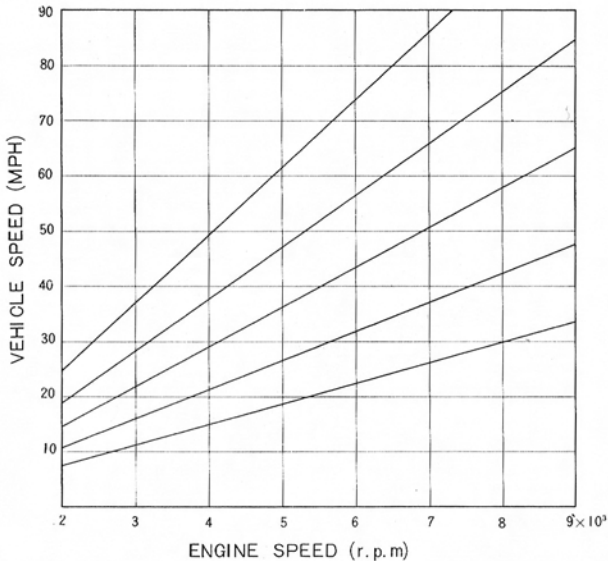

### RT1-MX

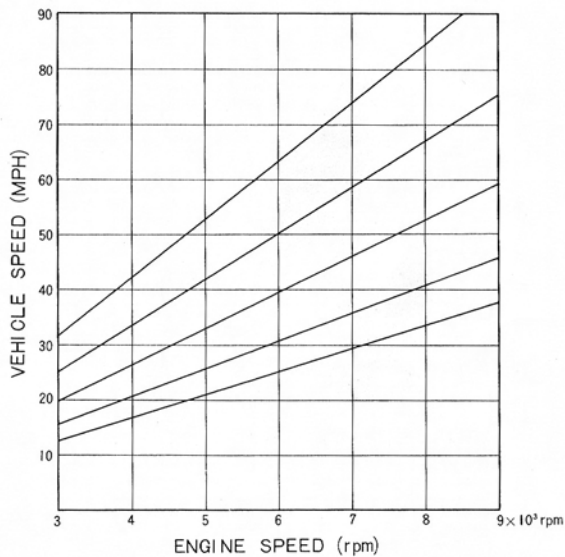

### 3. Pre-operation Check

You should check the following points before each usage.

(1) **Is there sufficient fuel?**

Make sure that there is sufficient fuel for your driving plan. Fill the fuel tank with gasoline only.

(2) **Is there sufficient oil?**

If the oil is below the center hole on the glass view port, refill the oil tank with Yamaha Autolube Oil (YAMALUBE).



(3) **Is the tire pressure correct?**

The wrong tire pressure affects riding comfort, steering, and life of tires.

Correct tire pressure:

Front — 14 lbs/in<sup>2</sup> (1.0 kg/cm<sup>2</sup>)

Rear — 17 lbs/in<sup>2</sup> (1.2 kg/cm<sup>2</sup>)

For on-the-road riding.

When the tire pressure is reduced below the specified value, the tire may slip around the rim. To prevent this slipping of the tire, bead stoppers should be used.

(4) **Do the front and rear brakes work effectively?**

Try the brake lever (right handlebar) and the foot brake (pedal on the right side of the engine). Check to see if the stoplight is functioning.

(5) **Do the lights and horn function well?**

Check the horn, stoplight, headlight, meter lamp, etc.

increase), and release the clutch lever gently. Done properly, the machine will accelerate smoothly.

c) Shifting

After starting off, accelerate to approximately 10 m.p.h. (15 km/h).

- Disengage the clutch while closing the accelerator grip.
- Shift into SECOND by raising the toe section of the change pedal one full position. (In this case, the neutral position is bypassed)
- Increase engine speed slowly and release the clutch lever. Accelerate to approximately 20~25 m.p.h. (30~40 km/h), and Shift into THIRD.
- Decelerate by reversing the above procedure. Close the accelerator grip, disengage the clutch, and then depress the change pedal.

No tachometer nor speedometer is provided for the RT1-MX. Shift gears according to the sound of the engine. Do not over-rev.

d) Notes on Riding with the RT1-B

Off-the-road Riding:

When you ride your motorcycle over rough land, safety parts may break or fall off due to shocks from the ground or due to accidents such as falling. It is advisable to remove all safety parts before you start riding.

Parts to be removed: Headlight, taillight, speedometer, tachometer, battery and side stand.

Caution on Riding over Paved Roads at High Speeds:

The RT1-B is equipped with tires having a block pattern. As a result, the area where the tire contacts the ground is smaller compared with other types of tires.

Therefore, take care not to slip your motorcycle when you are cornering at high speeds and at sharp angles.

### **(3) Stopping**

To stop the machine, gradually reduce speed by closing the throttle and apply the front and rear brakes simultaneously.

Applying only one brake may cause skidding or overturning.

Note: Braking procedure must allow for differing road conditions such as ice, snow, etc. Reduce brake pressure, apply the rear brake first, and, if necessary, intermittently operate the brakes to maintain stability on poor traction surfaces.

### **5. Break-in Procedure**

To secure a longer life for your Yamaha 360 RT1-B, a certain period of breaking-in operation is very important.

During the first 600 miles (1,000 km), the various parts of the engine wear and polish themselves to the correct operating clearances. It is important to avoid prolonged full throttle operation which might result in excessive heating during this critical period. Care taken at this time will result in longer life, better dependability and higher performance.

### **6. Cruising**

After break-in, a general rule of thumb for cruising is to operate at 1/2 ~ 3/4 throttle bearing in mind engine r.p.m., road conditions and the legal speed limit.

Vary your speed occasionally to "rest" the engine and avoid prolonged, full throttle operation.

## V. Service Tools

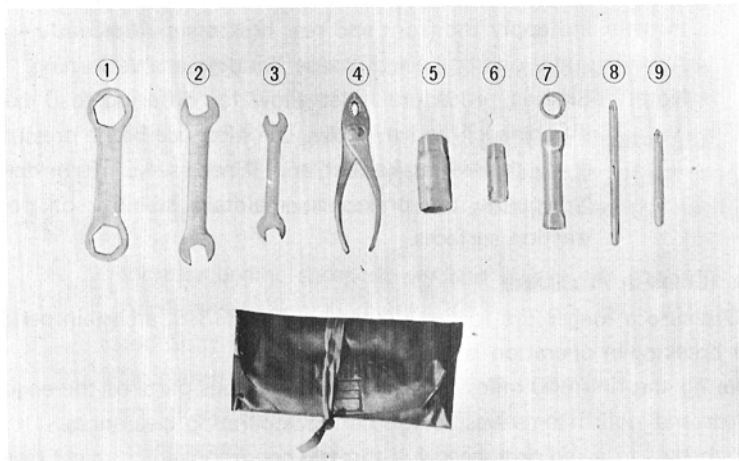

- ① 22X26 mm. Double-ended Spanner
- ② 13X17 mm. Spanner
- ③ 8X10 mm. Spanner
- ④ Plier
- ⑤ 17X21 mm. Socket wrench
- ⑥ 10 mm. Socket wrench
- ⑦ Screwdriver handle and 13 mm. socket wrench.
- ⑧ ⊕ ⊖ Screwdriver
- ⑨ ⊕ Screwdriver
- ⑩ Tool bag



## VI. Inspection and Service

Regular inspection and maintenance will keep your motorcycle in top condition.

Daily or periodic inspection by yourself or your Yamaha dealer not only assures a longer life for your motorcycle but prevents any machine trouble.

Remember to have the periodic inspection by your Yamaha dealer; otherwise, your machine will not be entitled to the Yamaha warranty plan. It is advisable, in addition to the periodic inspection at your Yamaha dealer according to the Periodic Inspection Card, that you check the machine parts listed below every 30 ~ 60 days.

### 1. Periodic Inspection Guide

	Check point	Instructions	P. Ref.
1	Front and rear brake	Adjustment	30, 31
2	Clutch	Adjustment	32, 33
3	Gear oil	Level and replacement	34
4	Battery electrolyte	Refilling	35
5	Spark plug	Cleaning	36
6	Air cleaner	Checking and cleaning	37, 38
7	Carburetor	Adjustment	38
8	Drive chain	Adjustment and oiling	39, 40
9	Muffler	Cleaning	40
10	Cylinder head and piston	Cleaning	41, 42
11	Screws, bolts and nuts	Retightening	43

Be sure to check the above points before long-distance touring.

## 2. Inspection and Adjustments

The methods of inspection and adjustment are discussed below. This information will be of value in your daily inspections.

### 1) Adjusting the Brakes

#### a) Front Brake

The correct free play of the front brake lever pivot point is 0.2 ~ 0.3 in. (5 ~ 8 mm.)

To adjust, turn the cable adjusting bolt located at the lever. After adjustment, be sure to tighten the lock nut fully.

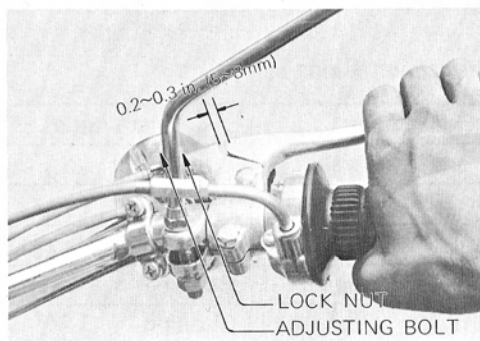

Note: The RT1-B is equipped with a front brake operated stoplight switch. During the above operation check the stoplight for proper operation.

## b) Rear Brake

The correct free play of the rear brake pedal is approximately 1 in. (25 mm.). To adjust the play, turn the adjusting nut that is attached to the rear brake cable end one-half turn at a time. After the adjustment, check the stoplight to see if it functions properly.

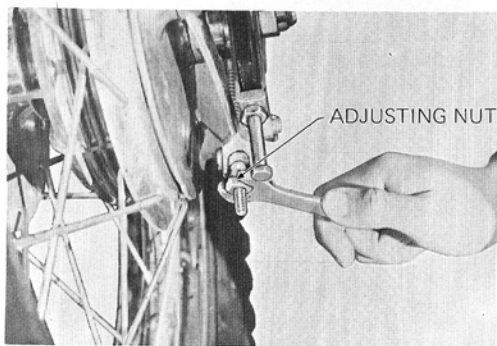
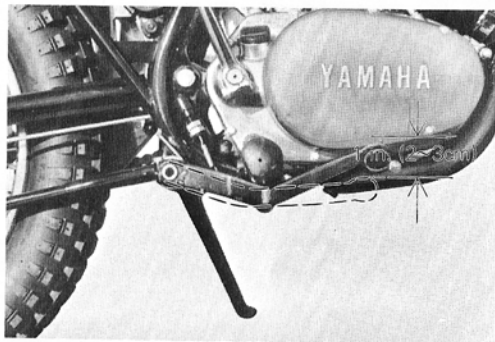

**Note:** This adjustment must be checked any time the chain is adjusted or the rear wheel is removed.

c) Checking the Brake Lining

Disassemble the wheel assembly every 3,000 miles (5,000 km), and check it for wear and clean the brake shoe and brake drum. Take care not to get any oil on the lining friction surface.

d) Adjusting the Clutch

The clutch lever should have 0.08 ~ 0.12 in. (2 ~ 3 mm) free play to maintain full pressure against the clutch facing. If the play is excessive, clutch engagement will be impaired. If the play is insufficient, the clutch will slip.

How to Adjust the Clutch:

To adjust the clutch, turn the adjusting bolt attached to the clutch lever holder. After the adjustment, fully tighten the lock nut(s).

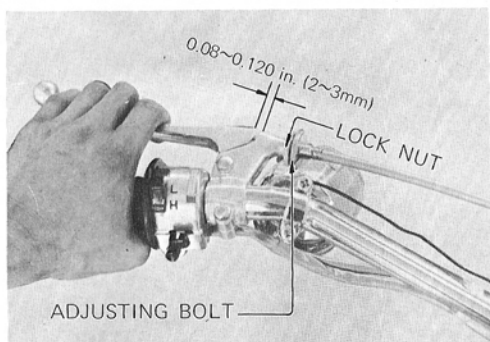

### Precision Adjustment Method:

- a) Remove the clutch adjusting cover from the left side of the crankcase cover. Fig. 17, and loosen the lock nut.
- b) Loosen the clutch adjusting screw (turn it to the left), and then tighten it slowly by turning it clockwise.
- c) Back it off 1/4 turn from a lightly seated position and lock it with the lock nut.
- d) Then re-adjust the play of the clutch cable with the adjusting bolt attached to the clutch lever holder.

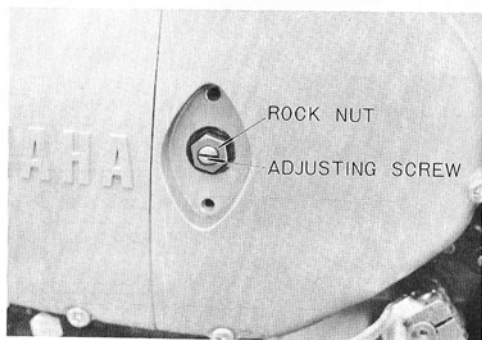
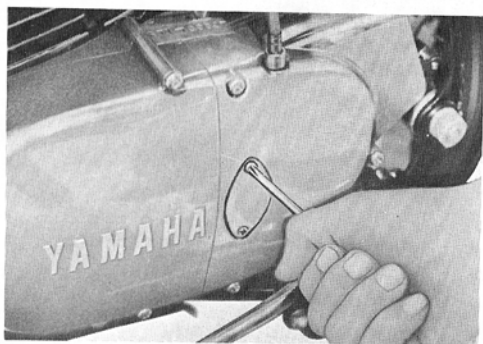

e) Replacing the Gear Oil

During the break-in period, replace the gear oil after 30 days from the date of purchase or after 300 miles (500 km) running. After the first time, replacement should be made every three months or 1,200 miles (2,000 km).

To drain the oil from the bottom of the crankcase, remove the oil drain plug.

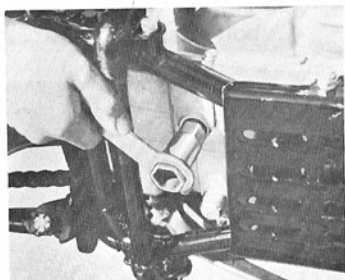
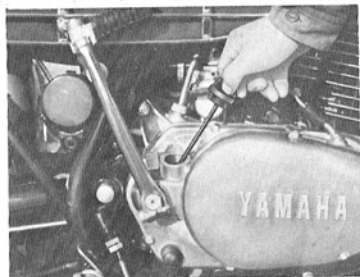

After draining the oil, fully tighten the oil drain bolt, and fill with new oil to the specified level.

Oil . . . . .SAE 10W/30 Motor Oil

Oil Amount . . . 1.0 U.S. qt. (1 lit.)

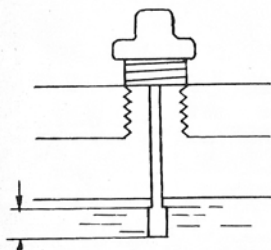

Keep the oil level between these level marks.

f) Checking the Battery Electrolyte (Applicable to the RT1-B only)

If the battery electrolyte is below the minimum level, remove the battery and add distilled water.

Check the overflow pipe to make sure it is not clogged or pinched Shut.

If your motorcycle will not be used for several months, remove the battery and keep it in dry, cool place, or have it kept in a service shop.

If sotred for more than 60 days, it should receive an occasional recharge. Before reinstallation, it should be fully charged.

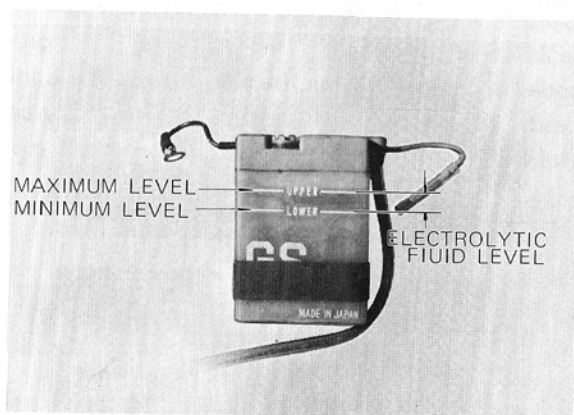



### g) Checking the Spark Plug

The spark plug ignites the air/fuel mixture in the cylinder. A dirty plug causes hard starting, engine misfiring and other problems. Clean carbon from the electrodes and adjust the point gap.

- Remove carbon build-up with a soft wire brush.
- Adjust the spark plug point gap to 0.020 ~ 0.024 in. (0.5 ~ 0.6 mm.).

Standard Spark Plug	RT1-B. . . . .	B-9ES
	RT1-MX . . . . .	B-9EN

- Porcelain around the center electrode should be a light tan color.
- Replace the spark plug if the electrodes and porcelain are eroded or cracked. If your machine is frequently ridden at low speeds, the spark plug will become somewhat oily and sooty. Replace it with a hotter B-8ES but, first, consult your dealer.

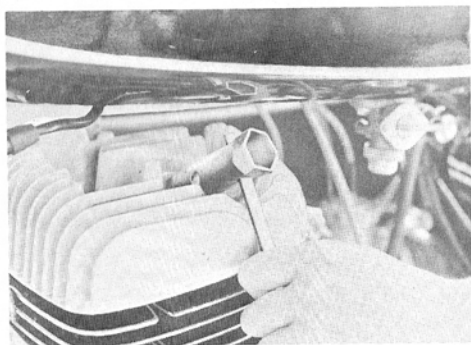
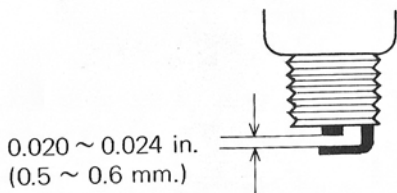

#### h) Cleaning the Air Cleaner

This model is equipped with a reusable, oil impregnated, foam air filter. **IT MUST BE REMOVED AND CLEANED AT LEAST ONCE A MONTH, MORE OFTEN IF THE MOTORCYCLE IS RIDDEN MAINLY IN THE DIRT** (preferably each time after you spend an entire day in the dirt).

- 1) Remove the air cleaner case cap fitting bolts.
- 2) The cleaner element can be pulled out.

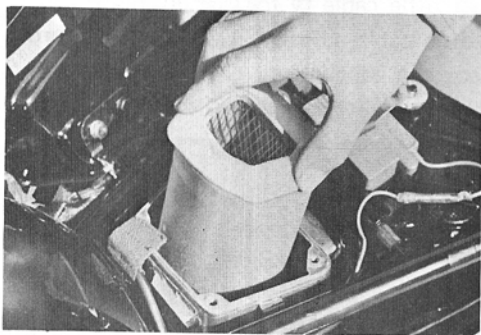
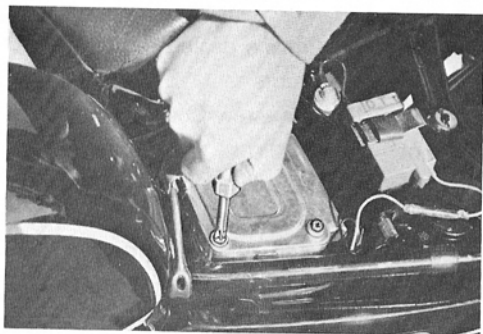

Wash the foam filter thoroughly in solvent until all dirt has been removed. Squeeze all the solvent out. Pour oil onto the filter (any grade of 20 or 30 wt), work it completely in, and then squeeze out the surplus oil. The filter should be completely impregnated with oil, but not "dripping" with it.

Under no circumstances should you run the motorcycle without the air filter. First, dirt and dust will be able to pass through into the cylinder. Premature engine failure will be the result. Secondly, more air will flow to the engine and there will not be enough gasoline for all the air. The lean mixture will result in higher engine temperatures and possibly severe engine damage.

i) Checking the Carburetor

Each carburetor is set by the factory after careful tests. Except for the following, do not change the carburetor setting without consulting your local Yamaha dealer.

1) Idling Speed Adjustments

- Tighten the pilot air screw ① until it lightly seats, and then back it off it 1-3/4 turns.
- Slightly loosen the adjusting screw of the throttle cable connected to the accelerator grip, and start the engine.
- After warming up the engine, turn the idle stop screw ② so that engine speed increases to 1,400 ~ 1,500 r.p.m. After this adjustment, loosen lock nut ⑤ to adjust the play of throttle cable ③ to 1/32 in. (0.5~1.0 mm.); and turn throttle cable adjuster ④ while pulling throttle cable ③ to check the adjustment. Then lock the throttle cable with lock nut ⑤.

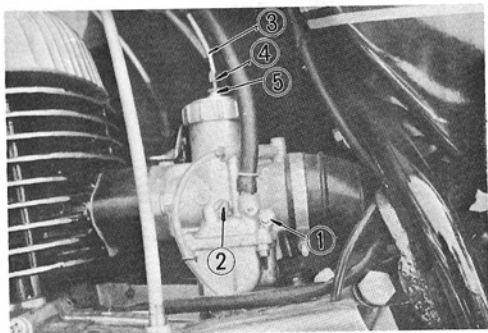

- Finally, check cable slack at the grip and adjust to 1/32" there also.

## 2) Adjusting the Pump Cable

After adjusting the carburetor, adjust the pump cable which is coupled with the throttle valve in the carburetor.

- Slightly turn the accelerator grip from the closed position so that free play of the accelerator grip is nil. (In other words, the throttle valve is ready to open with another slight turning of the throttle).
- Turn the pump cable adjusting nut so that the marking on the adjusting pulley is aligned with the guide pin.

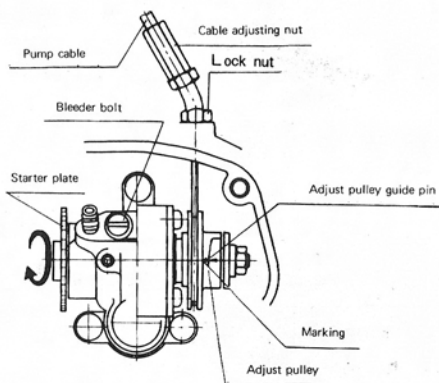

## j) Adjusting the Drive Chain

The drive chain should have approximately  $3/4 \sim 1$  in. (20~25 mm) up and down play at the center of the lower section with the rear wheel on the ground and rider in position. Since a dirty, dry chain causes excessive sprocket wear, apply oil at regular intervals. In addition, wash it in gasoline before oiling at every periodic inspection.

Adjusting Chain Tension:

- (1) Loosen the rear brake adjusting screw.
- (2) Loosen the tension bar nuts.
- (3) Loosen the chain adjusting bolt lock nuts ②.

- (4) Loosen the rear axle nut ①, and shift the wheel shaft so that both ends of the wheel shaft are positioned evenly by utilizing the marks on the swing arms.
  - (5) After adjusting by adjusting bolt ③, tighten the adjusting bolt lock nuts ② and axle nut ①.
  - (6) Adjust the play of the brake pedal.
- \* After these adjustments, check the play of the brake pedal and stoplight operation.

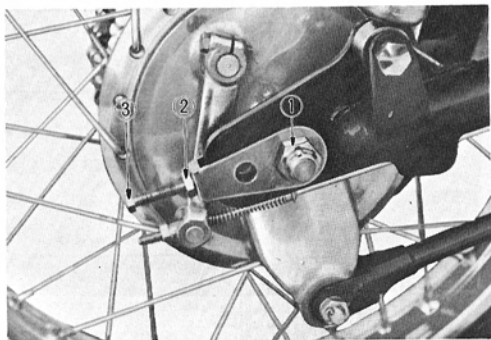

k) Cleaning the Muffler (Applicable to the RT1-B only)

To remove the inner cylinder from the muffler, remove the set screw and pull out the tail pipe.

Remove carbon with a wire brush. Check the inner bore for carbon. If is clogged, clean it with a wire.

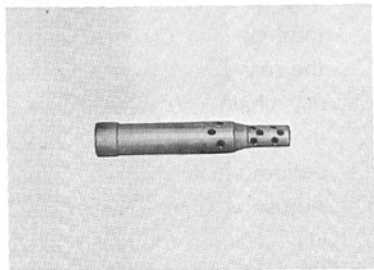

### 1) Cleaning the Combustion Chamber and Piston

Carbon deposits in the combustion chamber, on the head of the piston, in the exhaust port, and in the muffler are a constant cause of engine power loss. Decarbonization of these parts is relatively simple, requiring only a few tools. A torque wrench is one of the necessary tools. Going any further though, such as removing the carbon from ring grooves, should be done by a certified mechanic, as this requires cylinder removal.

Begin this servicing step by gradually loosening the four cylinder retaining nuts and the four bolts, in a pattern. **DO NOT LOOSEN EACH NUT COMPLETELY ALL AT ONCE**, but work around

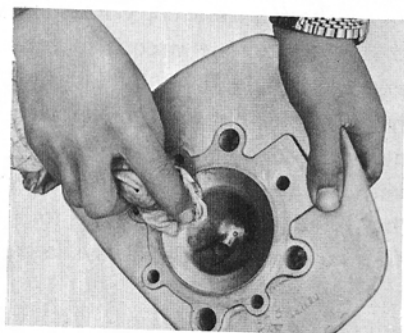
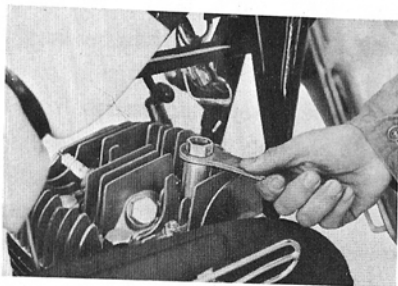

the cylinder head, loosening each nut 1/2 turn at a time. Slip the head off and use a dull or round edged scraper to remove the carbon from the combustion chamber (do not remove the spark plug). The round end of a hacksaw blade works quite well. Use a rag dipped in solvent and thoroughly clean the area. Do not scratch the gasket surface.

Bring the piston up to the very top and use the same scraping tool to remove the carbon from the top of the piston. Blow off as much of the loosened carbon as possible, then use the solvent soaked rag to pick up as much of the rest as possible.

Next, rotate the piston as far down as possible. Slip a dry rag down over the piston for protection. Disconnect the muffler. Very carefully use a small scraper and remove the carbon from the port opening (take care that it does not fall back into the cylinder).

As soon as possible, scrape the carbon from the exhaust port from the outside opening.

The head can now be put back onto the cylinder. Carefully wipe off the gasket surfaces of both parts. Position the head gasket (which should be a new one) on the cylinder. Slip the head into place and tighten the four retaining bolts and nuts until they are finger tight. Use the torque wrench to tighten them further. Total torquing pressure is 18 ft/lbs. for the four nuts and 30 ft/lbs. for the four bolts; but you should torque all four nuts and bolts in sequence, and in three progressive steps of increasing torque. First, you should torque all four bolts and four nuts with 10 ft/lbs. Next torque the four bolts to 30 ft/lbs. first, then torque the four nuts to 18 ft/lbs., always in cross pattern.

#### m) Cleaning the Fuel Cock Filter

The fuel cock filter removes impurities from gasoline before they flow into the carburetor. A dirty filter clogs the system, and



as a result, the engine will not run properly. Clean it from time to time. Remove the cup from the fuel cock and remove the filter. Wash it carefully in gasoline and reinstall.

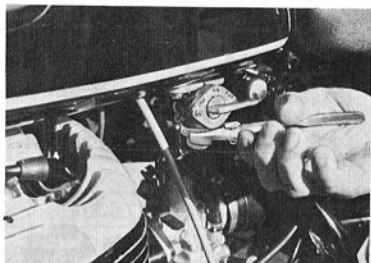

#### n) Retightening Screws, Bolts and Nuts

Check the screws, bolts and nuts in the parts listed below and retighten them if necessary.

Front and rear wheels

Foot rests

Swing arm shaft

Muffler

Side stand

Engine mountings

Carburetor

Air cleaner cover

Exhaust nuts

Rear cushions

Handlebars

o) Greasing and Oiling

	Parts to be lubricated	Distance of driving at 1st lubr., miles	Lubrication interval, miles	Type of Lubricant
1	Front brake cam shaft	600	2,000	cup grease
2	Rear brake cam shaft	600	2,000	"
3	Front brake cable	600	2,000	motor oil
4	Rear brake rod	600	2,000	cup grease
5	Accelerator grip	600	2,000	"
6	Stand shaft	600	2,000	"
7	Brake linkage	600	2,000	"
8	Drive chain	300	600	motor oil
9	Gear oil	300	1,200	"
10	Swinging arm shaft	600	2,000	cup grease

## VII. Conversion of the Yamaha RT1-B for racing\*

The Yamaha 360 RT1-B is easily converted into a high-performance motocrosser by installing GYT kit parts which convert it to RT1-MX.

\* It is suggested that when you desire to make this conversion, you enlist the services of your local Yamaha dealer.

### 1. Engine Tune-up

The engine can be tuned up by simply replacing standard parts with the bolt-on GYT kit accessory parts.

List of G. Y. T. Kit Parts.

Ref. No.	Parts No.	Parts Name	Description	Q'ty	Remarks
1	284-11111-00	HEAD, cylinder		1	
2	284-11311-00	CYLINDER		1	
3	284-11631-00-95	PISTON (STD)	79.95mm	} U.R.	
	284-11631-00-96	PISTON (STD)	79.96mm		
	284-11631-00-97	PISTON (STD)	79.97mm		
	284-11631-00-98	PISTON (STD)	79.98mm		
	284-11635-00	PISTON (1st O.S.)	80.25mm	1	
	284-11636-00	PISTON (2nd O.S.)	80.50mm	1	
4	183-16333-70	SPRING, clutch		6	
5	214-17411-60	AXLE, main	16T	1	
6	214-17121-60	GEAR, 2nd pinion	20T	1	
7	214-17211-60	GEAR, 1st wheel	36T	1	
8	214-17221-60	GEAR, 2nd wheel	33T	1	
9	214-17231-60	GEAR, 3rd wheel	29T	2	
10	241-17819-00	CAP, housing		1	
11	94700-00016	PLUG, spark	NGK B-9EN	1	
12	161-15426-00	COVER, oil pump		1	
13	284-14101-60	CARBURETOR ASS'Y	VM34SH	1	MIKUNI
14	137-14143-62	.JET, main	#310	1	
	137-14143-64	.JET, main	#320	1	
	137-14143-66	.JET, main	#330	1	S.T.D
	137-14143-68	.JET, main	#340	1	

26	92901-08100	WASHER, spring		2	
27	284-21786-00	EMBLEM MX		1	
28	94127-21071	TIRE, front	2.75-21-4PR	1	
29	94227-21031	TUBE, front	2.75-21	1	
30	94327-21024	BAND, rim	2.75-21	1	
31	94416-21038	RIM, front	1.60-21	1	
32	214-25104-10	SPOKE SET		1 set	
33	152-25139-00	PLUG, blind		1	
34	94140-18070	TIRE, rear	4.00-18-4PR	1	
35	214-25394-10	SPACER, beed		2	

RT1-MX is provided with these tuning parts.

### 3. Service Data (Tuning parts specifications)

Piston clearance ..... 0.0020 ~ 0.0022 in. (0.050 ~ 0.055 mm.)

Spark plug ..... Standard B-9EN

Ignition timing ..... B.T.D.C. 3.4 mm

Fuel mixing ratio (only for racing)

Autolube disconnected: 15 : 1 Oil in Gas.

Carburetor Setting Table

Name of Parts	Abbreviation	Specifications
Main Jet	M. J.	#320
Air Jet Diameter	A. J.	2.5 mm.
Jet Needle	J. N.	6DH2-3 stages
Needle Jet	N. J.	P-0
Throttle Valve Cut Away	C. A.	# 3.5
Bypass Port Diameter	B. P.	1.4 mm.
Pilot Outlet Diameter	P. O.	0.6 mm.
Pilot Jet	P. J.	#60
Air Screw	A. S.	Turns out 1¼
Valve Seat Diameter	V. S.	3.3 mm.
Starter Jet	G. S.	#60

## Float Level Adjustment

The carburetor float level is checked by the Yamaha factory during assembly and testing. But rough riding, worn needle valve, or bent float arm can cause the float level to fluctuate. If the float level raises, this will cause a rich fuel/air mixture that can cause poor performance and spark plug fouling. If the float level decreases, this can cause a lean fuel/air mixture that can result in engine damage. If the machine is subjected to continuous rough riding or many miles of travel, the float level should be checked and set regularly and in the following manner.

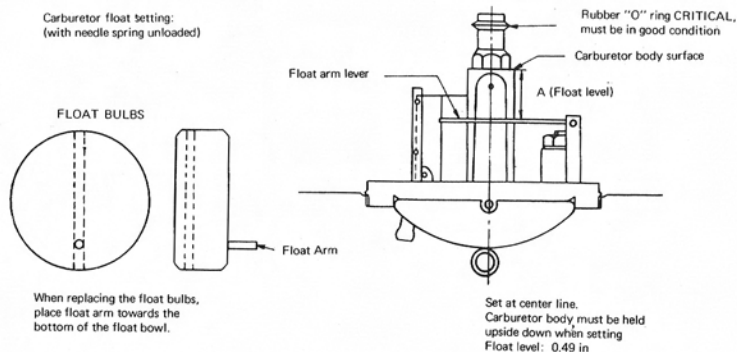

- 1) Remove the float chamber body, and turn over the mixing body. Let the float arm rest on the needle valve without compressing the spring.
- 2) Then measure the distance from the top of the float to the float bowl gasket surface.  
Standard measurement = 0.49"
- 3) When the distance measures less than the recommended distance, bend the tang up. If it is greater, bend the tang down. (with carburetor body upside down.)

#### **4. Change in Specifications**

Participants in racing must change specifications of the machine depending on conditions of the racing course, road surface, soil, length of straightaways, angles of curves, number of curves, slopes, weather, temperatures, and skill of the rider. These factors and conditions must be determined by the rider himself after trial running over the whole race course.

##### **Main Points to be Modified**

###### **1) Carburetor Setting**

In addition to the specified main jet, the rider should carry with him spare main jets whose numbers are several sizes larger and smaller.

###### **2) Secondary Reduction Ratio**

Consideration should be given to a combination of the drive sprocket and rear wheel sprocket so that the motorcycle pulls easily in 3rd and 4th.

###### **3) Spark Plug**

Change the plug if necessary by judging discoloration of the spark plug.

Choose the most suitable one from B-8EN, B-9EN, or B-10EN.

###### **4) Tire Pressure**

Adjust the tire pressure according to track conditions and the rider's choice. When the tire pressure is reduced below the specified value the tire may slip around the rim. To prevent this slipping of the tire, bead stoppers should be used.

###### **5) Front Fork**

Adjust the front fork by adjusting the quantity or weight of oil. The oil amount is in the range of 210 to 220 cc. each.

###### **6) Rear Cushions**

Adjust the spring depending on the rider's choice.

###### **7) Handlebar**

Loosen the handle lever holder before racing. It will protect the rider's hands or fingers from getting injured in case of an accidental crash during the race. (The lever can easily turn when the machine turns over).

This should occur after 1 ~ 2 hours of slow speed operation. The racer should devote the maximum possible time to inspection and service of the machine prior to racing. **“Thorough inspection and service are the first step to victory.”**

## **5. Miscellaneous Notes**

Racing demands the most out of the machine as well as high performance and extra durability.

Accordingly, thorough inspection and service of the machine before racing are very important. In particular, the engine will be operated at high speeds for many consecutive hours. Hence, even a minor defect may result in engine troubles.

Be sure to check and service the machine with special care prior to racing.

The newly tuned engine must be handled in the same manner as a brand new machine, so it requires a certain period of breaking-in. In contrast to a street machine, the piston should be inspected after break-in which should, for racing, include a period of riding under racing conditions. The racer should devote the maximum possible time to inspection and service of the machine prior to racing. **“Thorough inspection and service are the first step to victory.”**

# RT1-MX WIRING DIAGRAM

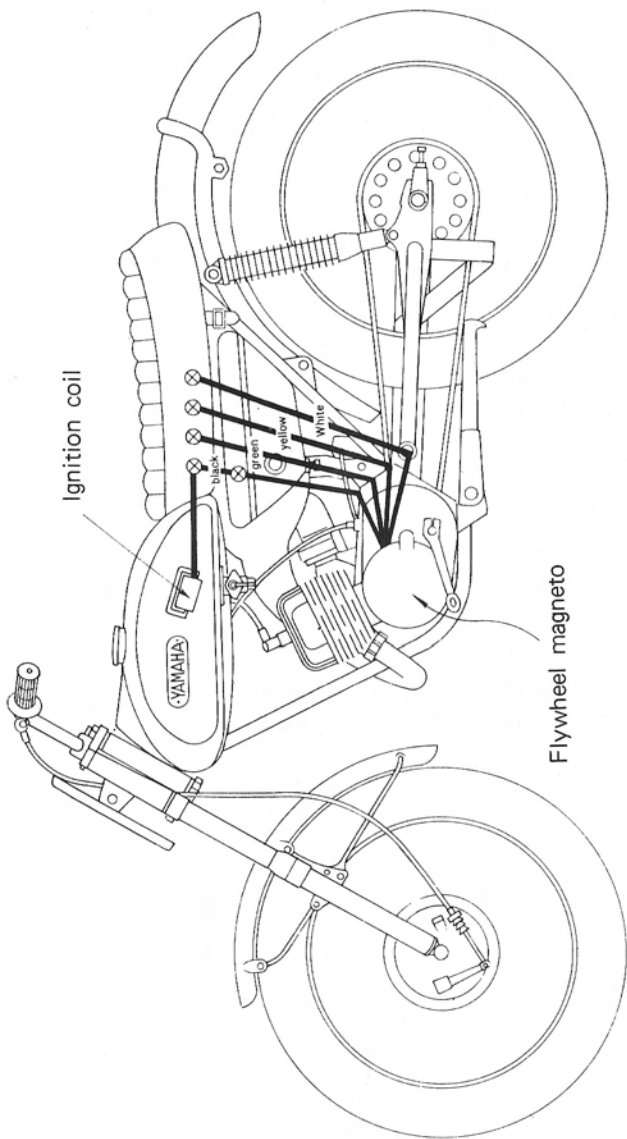



# WIRING DIAGRAM

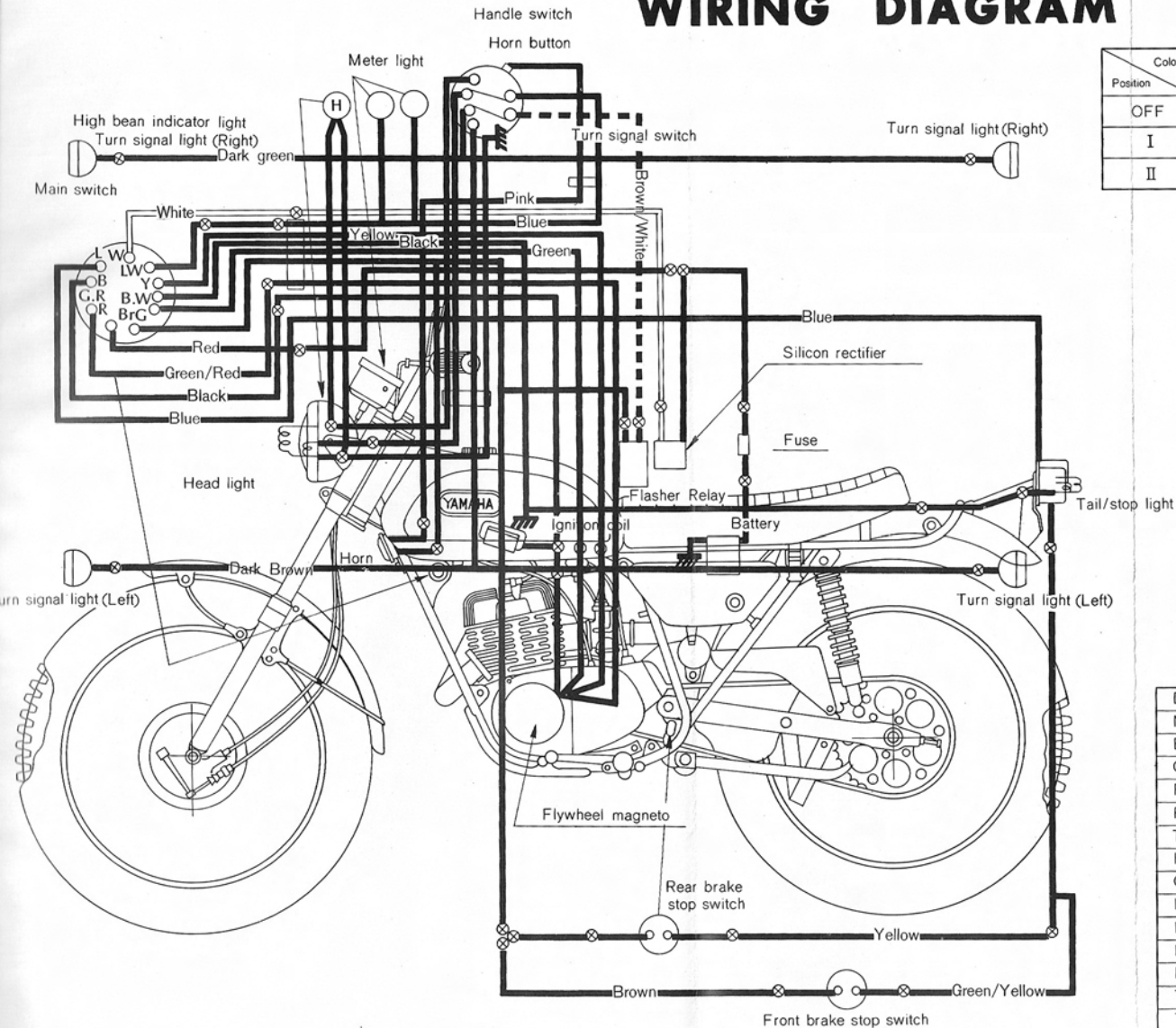

Position	Color										
	E	B	R	Br	L	G	W	GR	LW	Y	
OFF	○	○									
I			○	○		○	○				
II			○	○	○		○	○	○	○	

Chart of wire colors

Daytime charging circuit	Green
Night time charging circuit	Green/Red
Battery (+) circuit	Red
Ground circuit	Black
Front brake stop light circuit	Green/Yellow
Rear brake stop light circuit	Yellow
Tail light circuit	Blue
Head/Meter light circuit	Blue(L, W)
Common circuit	Brown
Head light main circuit	Yellow
Head light sub circuit	Green
Horn circuit	Pink
Rectifier circuit	White
Turn signal light (Right) circuit	Dark green
Turn signal light (Left) circuit	Dark Brown
Turn signal relay circuit	Brown/White



**YAMAHA MOTOR CO, LTD.**

PRINTED IN JAPAN