



YAMAHA

IT250E/400E

OWNER'S SERVICE MANUAL

IMPORTANT NOTICE

This motorcycle may be equipped either for competition use or general off-road use. It may be illegal to operate this vehicle off-road when it is equipped for competition use. Check your state and local riding area regulations. This vehicle is not manufactured for use on public streets, roads or high ways. Such use is prohibited by law. An off-road riding kit is provided with each vehicle to

comply with noise level and spark arrester laws and regulations for installation instructions see directions in this manual. Performance will be substantially decreased. Returning is not required.

IT250E/IT400E OWNER'S SERVICE MANUAL

1st Edition, July 1977

2nd Printing, July 1978

ALL RIGHTS RESERVED BY
YAMAHA MOTOR CORPORATION, U. S. A.
BUENA PARK, CALIFORNIA 90620

LIT-11626-00-89

TO THE NEW OWNER

Yamaha's IT250E/400E are designed and built by Yamaha engineers for both the rigors of off-road use. It offers many outstanding features, not found on previous Yamaha machines. This owner's service manual provides the basic information for operation and proper care and maintenance. Careful attention to the procedures described in this manual will help insure trouble free operation and optimum performance.

Additional information regarding major repairs, such as crank case disassembly, can be found in other publications available from your authorized Yamaha dealer.

Particularly important information is distinguished in this manual by the following notations:

NOTE:

A NOTE provides key information to make procedures easier or clearer.

CAUTION:

A CAUTION indicates special procedures that must be followed to avoid damage to the machine.

WARNING:

A WARNING indicates special procedures that must be followed to avoid injury to a machine operator or person inspecting or repairing the machine.

CONTENTS

NOMENCLATURE	1
MACHINE IDENTIFICATION	2
CONTROL FUNCTIONS	3
OPERATION	9
PERIODIC MAINTENANCE	13
MECHANICAL ADJUSTMENT	19
ENGINE MAINTENANCE AND MINOR REPAIRS	30
CHASSIS MAINTENANCE AND MINOR REPAIR	56
ELECTRICAL	73
INTERCHANGEABILITY OF C.D.I. MAGNETO AND TRANSMISSION	77
INSTALLATION OF THE OFF-ROAD RIDING KIT	80
CLEANING AND STORAGE	84
MISCELLANEOUS	86
SPECIFICATIONS	87
WARRANTY INFORMATION	93

NOMENCLATURE

Right hand side

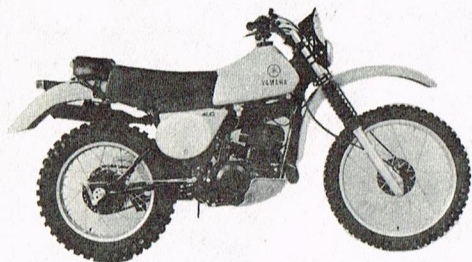

Left hand side

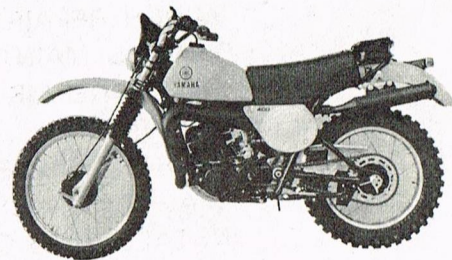

MACHINE IDENTIFICATION

Frame serial number

The frame serial number is stamped on the right side of the steering head stock.

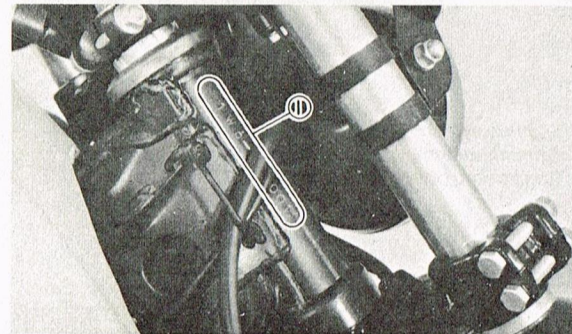

1. Frame serial number

Engine serial number

The engine serial number is stamped into the raised part of the right rear section of the engine.

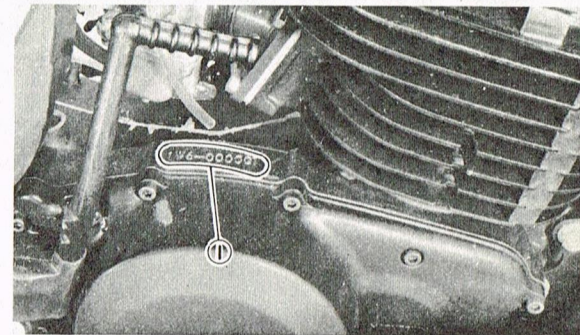

1. Engine serial number

NOTE:

The first three digits of these numbers are for model identifications; the remaining digits are the unit production number. The engine and frame serial numbers are usually identical.

CONTROL FUNCTIONS

Handlebar switches

The handlebar switches are located near the left handle grip. They have the following functions.

Engine stop button

The engine stop button is located on the left handlebar. Push and hold to stop engine.

Lighting switch

If the light switch is turned forward, headlight and taillight come on.

Dimmer switch

Turn to the "H" position for the high beam and to the "L" position for the low beam.

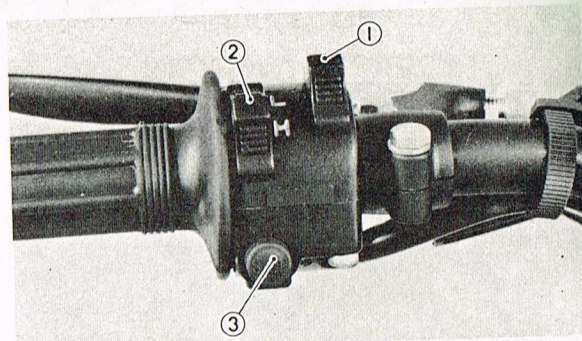

1. Lighting switch
2. Dimmer switch
3. Engine stop button

Fuel petcock

The fuel petcock conducts fuel from the tank to the carburetor and also filters the fuel. The fuel petcock has the following three positions:

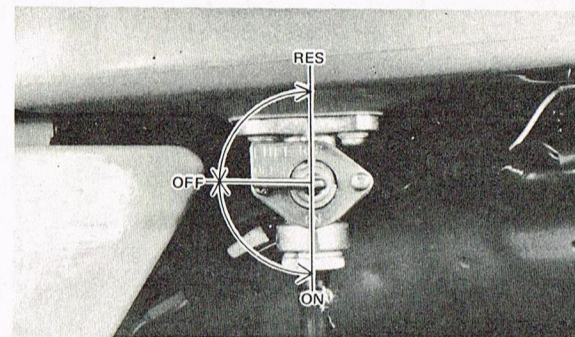

- OFF:** With the lever in this position fuel will not flow. Return the lever to this position when the engine is not running.
- ON:** With the lever in this position fuel flows to the carburetor. Normal riding is done with the lever in this position.
- RES:** This indicates "RESERVE". If you run out of fuel while riding, move the lever to this position. Then, fill the tank at the first opportunity.

Front brake lever

Located on the right handlebar. The front brake lever actuates the single leading-shoe front brake when the brake lever is squeezed.

Rear brake pedal

Located directly in front of the right-side rider's foot rest. The rear brake pedal actuates the single-leading shoe rear brake when the pedal is depressed.

Clutch lever

Located on the left handlebar. The clutch lever will disengage the wet-type, multiplate clutch when the lever is squeezed.

Throttle

The throttle is the positive return type, and is located on the right handlebar grip.

Kick crank (Kick starter)

The kick starter crank is located on the right, rear side of the engine. Rotate the crank out, press your foot upon it firmly, push down until the gears engage the primary drive train and kick briskly to start the engine. Fold the crank in after engine starts.

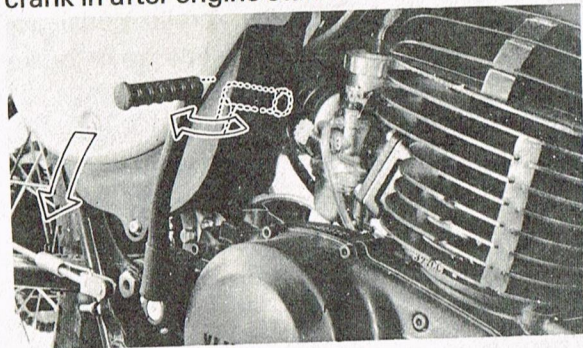

The kick mechanism is of the primary type. Therefore, the engine may be started in any gear, provided the clutch is disengaged.

Gear shifting

The gear ratios of the constant mesh 5-speed

(IT400E) and 6-speed (IT250E) transmission are ideally spaced.

The gears can be shifted by using the change pedal on the left side of the engine.

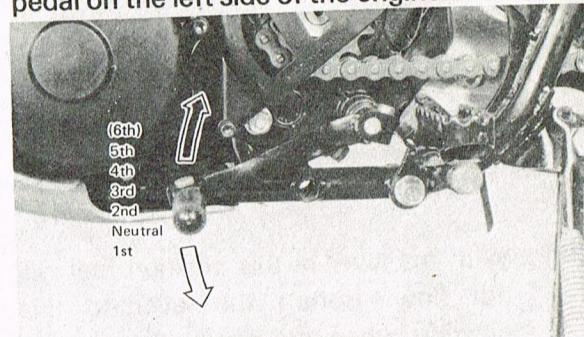

Carburetor starter jet (Lever)

The carburetor starter jet is located on the left-side of the carburetor assembly. The jet is designed to supply an extra-rich fuel/air mixture for cold engine starts. It is actuated by a lever. Push the lever down to open the jet. Always close the jet after the engine is running smoothly. Never ride the machine with the lever down.

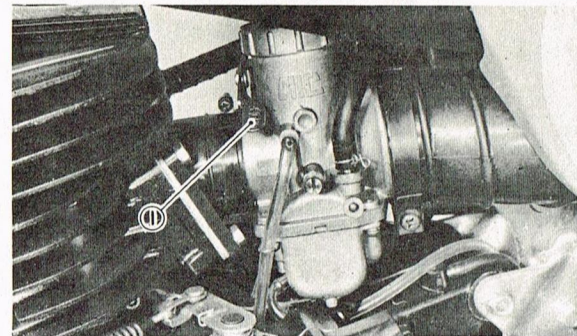

1. Starter jet lever

Speedometer

The odometer and trip odometer are built into the speedometer. The trip odometer can be reset to "0" by turning the reset knob in the following two manners:

1. Turn the knob counter clockwise for resetting the entire place numbers to zeros.
2. Pull the knob and turn it either way for place-by-place reading adjustment.

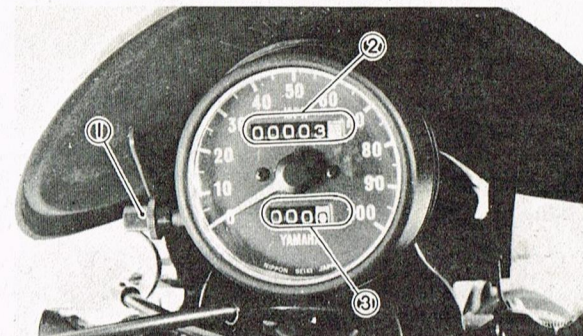

1. Reset knob
2. Odometer
3. Trip odometer

Tool kit

The owner's tool kit contains the tools which enable the owner to perform simple adjustments or periodic maintenance.

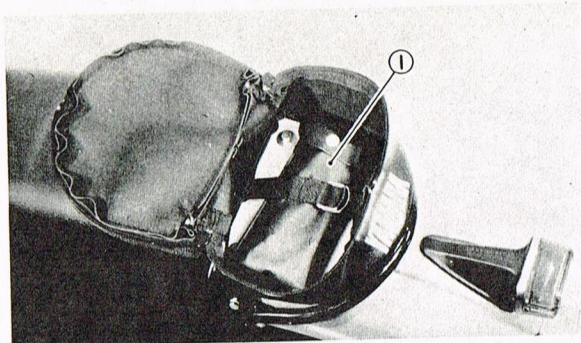

1. Tool kit

Fuel

Use premium gasoline with an octane rating of 90+ mixed with oil at a gas/oil ratio of 20:1. Always use fresh, name-brand gasoline. Always mix a fresh batch of fuel the morning of the race and do not retain a mixed batch overnight.

Fuel tank capacity: 12 lit (12.7 U.S. qt)

Oil

1. Engine Mixing Oil:

Recommended oil: Yamalube "R"
(Yamalube Racing 2-cycle oil)

If for any reason you should use another type, the oil should meet BIA certification. "TC-W".

Check the container top or label for service specification and mixing ratios.

2. Transmission Oil:

Recommended oil: Yamalube 4-cycle
oil or SAE 10W/30 "SE" name-
brand motor oil

The transmission filler plug is located above the kick starter.

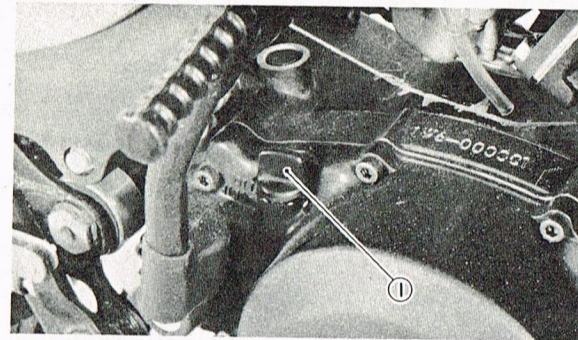

1. Filler plug

On the bottom of the engine there is a drain plug. Remove it and drain all the oil from the transmission. Reinstall the drain plug (make sure it is tight). Add oil through filler hole.

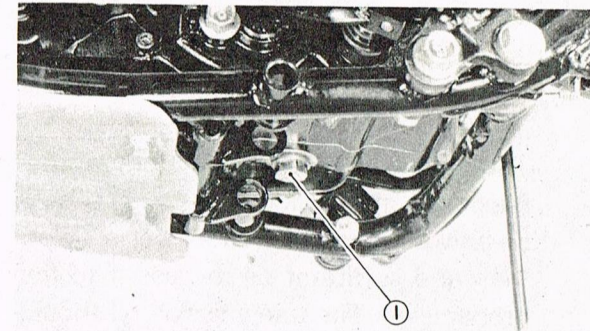

1. Drain plug

Transmission oil capacity

Oil change	1,050~1,150 cc (1.1~1.2 U.S.qt)
Total	1,150~1,250 cc (1.2~1.3 U.S.qt)

To check the level, warm the engine up for several minutes, stop engine, screw the dip stick completely out and then just reset the stick in the hole.

NOTE:

Be sure the machine is positioned straight up and on both wheels.

The dip stick has a minimum and a maximum marks, and the oil level should be between the two. If the level is lower, then add sufficient oil to raise it to the proper level. The transmission oil should be drained and refilled every second meet.

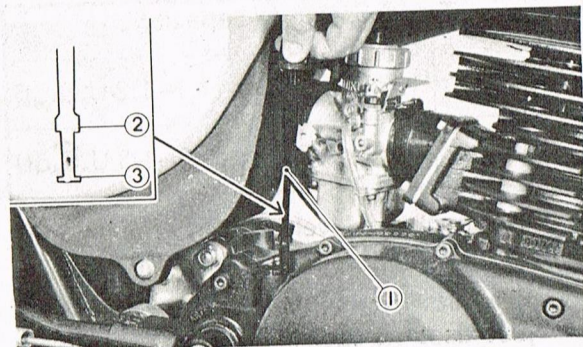

1. Dip stick
2. Maximum mark
3. Minimum mark

OPERATION**CAUTION:**

1. Before riding this motorcycle, become thoroughly familiar with all operating controls and their function. Consult your Yamaha Dealer regarding any control or function you do not thoroughly understand.
2. Observe the break-in procedures to preclude mechanical failures.
3. This model is designed for OFF-ROAD use only. It is not equipped with highway approved lighting, mirrors, horn or directional signals. In most instances, it is illegal to ride this model (either day or night) on any public street or highway.

PRE-OPERATION CHECK LIST

ITEM	ROUTINE	PAGE
BRAKES	Check operation/adjustment	19 - 21
CLUTCH	Check operation/lever adjustment	21 - 22
FUEL TANK	Fill with proper fuel/oil mix	7
TRANSMISSION	Change oil as required	7 - 9
DRIVE CHAIN	Check alignment/adjustment/lubrication	22 - 23
SPARK PLUG	Check condition/clean or replace as required	26 - 27
THROTTLE	Check for proper cable operation	24
AIR FILTER	Foam type - must be clean and damp with oil always	30 - 32
WHEELS & TIRES	Check pressure/runout/spoke tightness/axle nuts	59 - 64
FITTINGS/FASTENERS	Check all/tighten as necessary	-
LIGHTS	Check for proper operation	3

NOTE:

Pre-operation checks should be made each time machine is used. Such an inspection can be thoroughly accomplished in a very short time and the added safety it assures is more than worth the time involved.

BREAK-IN PROCEDURE

1. Prior to starting, fill tank with a break-in gasoline/oil mixture of 12:1 to 14:1.
2. After fueling and pre-operational checks have been made, refer to Starting and Operation and start engine.
3. Allow engine to warm up. Check engine idle speed. Check operating controls and engine stop button operation.
4. Operate machine in lower gears at moderate throttle settings for 3 — 5 minutes. Check spark plug condition.
5. Allow engine to cool. Repeat procedure, running for 5 minutes. Very briefly, shift to higher gears (4th or 5th) and check full throttle response. Check spark plug condition.
6. Allow engine to cool. Repeat procedure, running for 5 minutes. Full throttle and higher gears may be used, but avoid sustained full throttle operation. Check spark plug condition.
7. Allow engine to cool. Remove top end and inspect. Remove "high" spots on piston with No. 600 grit, wet sandpaper. Clean, and carefully reassemble.
8. Remove break-in fuel/oil mixture from tank. Refill with 20:1 operating fuel/oil mixture. Check entire unit for loose or misadjusted fittings/controls/fasteners.
9. Re-start engine and check through entire operating range thoroughly. Stop. Check spark plug condition. Re-start. After 10 — 15 minutes operation, machine is ready to OFF-ROAD riding.

STARTING AND OPERATION

CAUTION: Prior to operating the machine, perform steps listed in pre-operation check list.

NOTE: Observe break-in procedures for initial operation

Starting cold

1. Turn the fuel petcock to "ON".
2. Operate the carburetor starter jet (choke) lever and completely close the throttle grip.
3. Kick the kick crank with full strength to start the engine.
4. After the engine starts, warm up for one or two minutes. Make sure the starter jet (choke) lever is returned to the original position before riding.

Starting with engine warm

Do not engage starter jet. Open throttle slightly. Engage the kick starter and start the engine.

Warm-up

Run the engine at idle or slightly higher using the starter jet as required until the engine is warm. This procedure normally takes 1 to 2 minutes. To check, see if the engine responds normally to throttle with starter jet off.

CAUTION: Do not operate engine for extended warm-up periods.

Shifting

A 5-speed transmission is used for IT400E and a 6-speed transmission for IT250E. Low gear is at the bottom of the shift pattern; high gear at the top of the shift pattern; neutral is located half-way between first and second positions.

The shift mechanism is of the ratcheting type common to most motorcycles. Allow the lever to return to its "at rest" position prior to selecting another gear. Neutral is selected by pulling up or depressing on the shift lever halfway between first and second gears. With the engine running in the neutral position, disengage the clutch (pull in clutch lever), press down on the shift lever until low gear is engaged, remove foot from shift lever, increase engine speed slightly, slowly release clutch lever while advancing throttle. Repeat procedure for remaining gears.

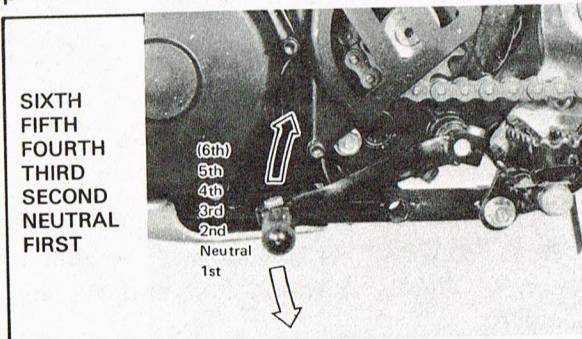

PERIODIC MAINTENANCE

The maintenance and lubrication schedule chart should be considered strictly as a guide to general maintenance and lubrication intervals. You must take into consideration that weather, terrain, geographical locations, and a variety of individual uses all tend to demand that each owner alter this time schedule to match his environment. For example, if the motorcycle is continually operated in an area of high humidity then all parts must be lubricated much more frequently than shown on the chart to avoid rust and damage. If you are in doubt as to how closely you can follow these time recommendations, check with the YAMAHA dealer in your area.

MAINTENANCE AND LUBRICATION SCHEDULE CHART

	After Every Ride	Every 500 km	Every 1,300 km	After Every Event	As Required	Recommended Lubricant type
WASH MACHINE	(This item is also essential to proper performance)				x	
PISTON Inspect Clean Replace		x x		x x	x	
PISTON RING Inspect Replace		x	x	x	x	
CYLINDER Inspect Head torque Replace		x x		x x	x	
CLUTCH Adjust Replace (Plates)					x x	
TRANSMISSION Oil change Inspect gears/ Shift mech. Replace bearings		x	x	x	x x	NO. 1

	After Every Ride	Every 500 km	Every 1,300 km	After Every Event	As Required	Recommended lubricant type
CRANKSHAFT Main bearing check Big end check Small end check Piston pin check			x x	x x		
CARBURETOR Clean, inspect, & adjust		x		x		
EXHAUST SYSTEM Inspect & tighten Clean and decarbonize		x		x	x	
FRAME Clean & inspect		x		x		
SWING ARM Check lubricate		x	x	x	x	NO. 5
CONTROLS & CABLES Check & adjust Lubricate	x	x		x x		NO. 2
BRAKES Check & adjust Replace linings		x		x	x	

	After Every Ride	Every 500 km	Every 1,300 km	After Every Event	As Required	Recommended lubricant type
WHEELS & TIRES Check runout Check spokes Check bearings	x	x x		x x x		
STEERING HEAD Check Clean, lube & repair		x	x	x x (every two events)		NO. 6
CDI Check connectors		x		x		
AIR FILTER Clean & oil Replace	x			x	x	NO. 3
SPARK PLUG Check condition	x					
DRIVE CHAIN Clean & lubricate Check tension Replace	x x			x	x	NO. 2
FUEL TANK Clean & flush Clean petcock filter		x	x	x x		

	After Every Ride	Every 500 km	Every 1,300 km	After Every Event	As Required	Recommended lubricant type
REAR SHOCK Clean & inspect				x		
FRONT FORKS Clean & change oil Replace seals		x		x	x	NO. 4
CLUTCH & BRAKE SHAFTS Lubricate		x		x		NO. 5

RECOMMENDED LUBRICANT

- NO. 1 Use Yamaha 4-cycle oil or SAE 10W/30 "SE" motor oil.
- NO. 2 Use Yamaha Chain and Cable Spray lubricant or SAE 10W/30 "SE" motor oil.
- NO. 3 Air filters-foam element air filters must be damp with oil at all times to function properly. Clean and lube every meet and every ride. Do not over-oil. Use SAE 10W/30 "SE" motor oil.
- NO. 4 Use Yamaha Fork Oil 20W.
- NO. 5 Use lithium base grease.
- NO. 6 Medium-weight wheel bearing-grease of quality manufacturer — preferably water-proof.

SPECIAL TOOLS

The maintenance procedures outlined within this manual require special tools and instruments. A list of the special tools is given below.

- * 1. Outside Micrometer (0 ~ 25 mm)
Outside Micrometer (25 ~ 50 mm)
Outside Micrometer (50 ~ 75 mm)
- * 2. Magnetic Base (75 ~ 100 mm)
- * 3. Cylinder Gauge (50 ~ 100 mm)
- * 4. Vernier Caliper (0 ~ 150 mm)
- * 5. Torque Wrench
- * 6. Clutch Holding Tool
- * 7. Steering Nut Wrench
- * 8. Measuring Cylinder (0 ~ 250 cc, 10 cc increments)
- * 9. Dial Gauge
- * 10. 56 mm dial gauge needle
- * 11. Dial Gauge Stand # 2
- * 12. Flywheel Puller
- * 13. Thickness Gauge

* 14. Flywheel holding tool

* 15. Pocket tester

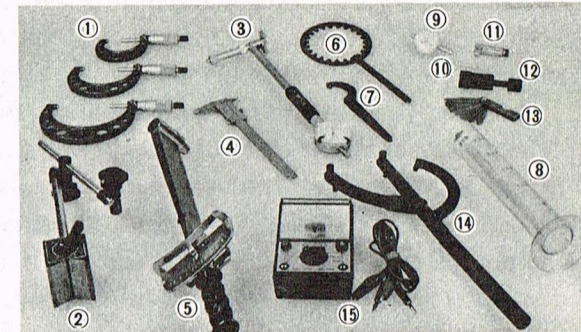

NOTE: _____
Those items marked with an-asterisk (*) available from Yamaha.

NOTE:

The Research and Engineering Departments of Yamaha are continually striving to further perfect all models. Improvements and modifications are therefore inevitable. In light of this fact, the foregoing specifications are subject to change without notice to the owner. Information regarding significant changes is forwarded to all Authorized Yamaha Dealers as soon as available. If a discrepancy is noted, please consult your dealer.

MECHANICAL ADJUSTMENTS

Front brake

Front brake should be adjusted to suit rider preference with a minimum cable slack of 5 — 8 mm (0.2 — 0.32 in) play at the brake lever pivot point.

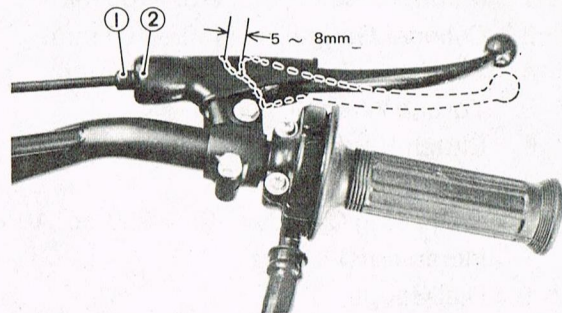

1. Adjuster
2. Lock nut

Adjustment is accomplished at one of two places; either the handle lever holder or the front brake hub.

1. Loosen the adjuster lock nut.
2. Turn the cable length adjuster in or out until adjustment is suitable.
3. Tighten the adjuster lock nut.

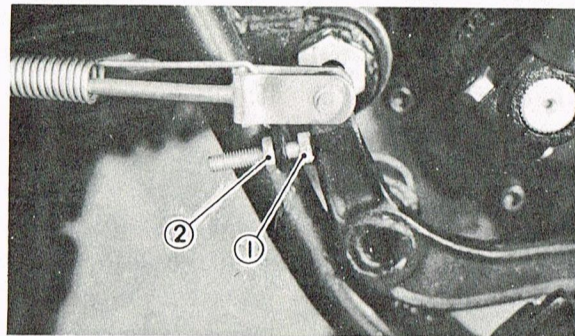

1. Adjuster
2. Lock nut

Brake pedal position

The position of the rear brake pedal should be adjusted with relation to the foot rest. Loosen the lock nut and adjust the pedal height by turning the adjusting bolt.

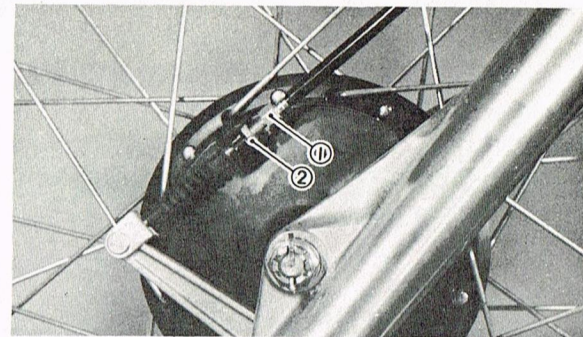

1. Adjuster
2. Lock nut

Rear brake

Adjust rear brake pedal play to suit, providing a minimum of 20 — 30 mm (0.80 — 1.20 in) freeplay. Turn the adjusting nut on the rear brake ferrule in or out until brake pedal freeplay is suitable.

NOTE:

Rear brake pedal adjustment must be checked anytime chain is adjusted or rear wheel is removed and then reinstalled.

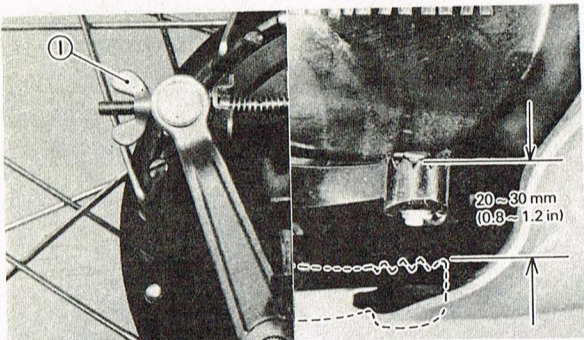

1. Adjuster

Clutch

This model has two clutch cable length adjusters and a clutch mechanism adjuster. Cable length adjusters are used to take up slack from cable stretch and to provide sufficient freeplay for proper clutch operation under various operating conditions. The clutch mechanism adjuster is used to provide the correct amount of clutch "throw" for proper disengagement.

Normally, once the mechanism is properly adjusted, the only adjustment required is maintenance of freeplay at the clutch handle lever.

Freeplay adjustment

Loosen either the handle lever adjuster lock nut or the cable inline length adjuster lock nut. Next, turn the length adjuster either in or out until proper lever freeplay is achieved (see illustration).

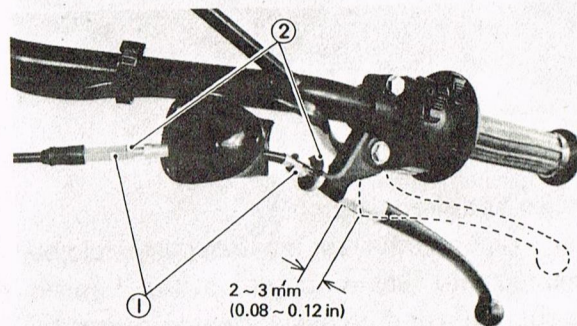

1. Adjuster
2. Lock nut

Mechanism adjustment

1. Fully loosen the cable in-line length adjuster lock nut and screw in the adjuster until tight.
2. Turn the handle lever adjuster in.
3. Remove the rear brake rod from lever. Remove footrest and brake pedal. Remove kick crank.
4. Drain the transmission oil and remove the crankcase cover (R).
5. Loosen the clutch mechanism adjuster lock nut.

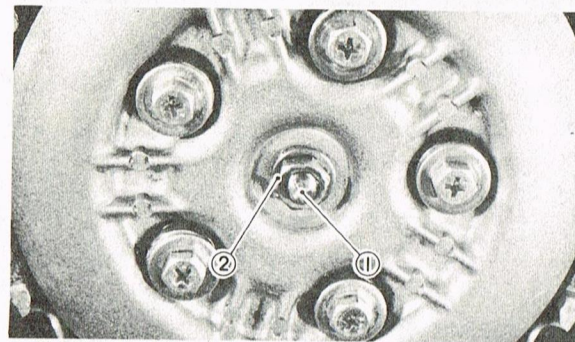

1. Eccentric adjuster
2. Lock nut

6. Push the push lever toward the front with your finger until it stops. With the push lever in this position, turn the adjuster in until the push lever mark and crankcase match mark are aligned. Tighten lock nut.

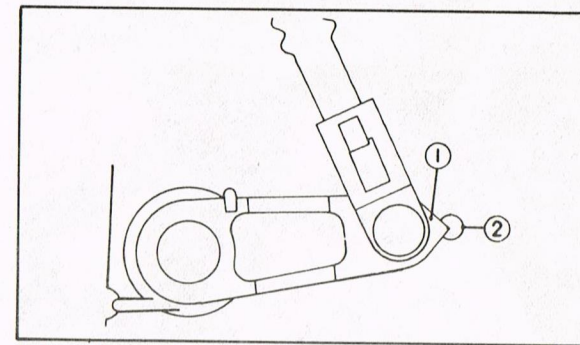

1. Push lever mark
2. Case match mark

7. Install the crankcase cover, kick crank, and footrest, brake pedal and brake rod. Readjust clutch lever freeplay as required.

Drive chain tension check

Inspect the drive chain with both tires touching the ground. Check the tension at the position shown in the illustration. The normal vertical deflection is approximately 40 — 50 mm (1.6 — 2.0 in). If the deflection exceeds 50 mm (2.0 in) adjust the chain tension.

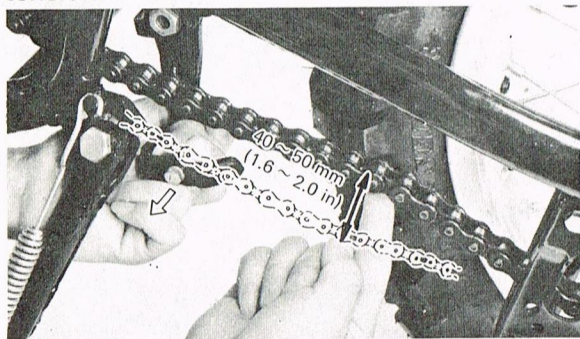

NOTE:

Tension inspection and adjustment should be made with the tensioner in the relaxed position (not touching the chain).

Drive chain tension adjustment

1. Loosen the rear brake adjuster.
2. Loosen the rear wheel axle nut.

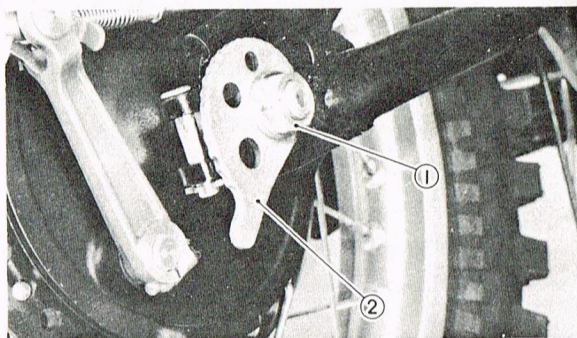

1. Axle nut
2. Chain puller

3. Turn chain puller cam both left and right, until axle is situated in same cam slot position.

NOTE:

Before adjusting, rotate rear wheel through several revolutions and check tension several times to find the tightest

point. Adjust chain tension with rear wheel in this "tight chain" position.

4. Tighten the rear axle nut.

Axle nut torque:

9.0 m·kg (64.8 ft·lb)

5. In the final step, adjust the play in the brake pedal.

Carburetor

Under normal operating conditions, there are only two adjustments to be made to the carburetor.

Throttle cable adjustment

Check play in turning direction of throttle grip. The play should be 3 — 5 mm (0.12 — 0.20 in) at grip flange, loosen the lock nut and turn the wire adjuster to make the necessary adjustment.

Tighten the adjuster lock nut.

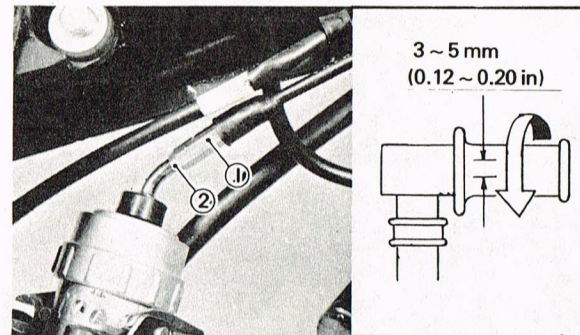

1. Lock nut
2. Adjuster

Idle speed and idle air adjustments

1. Turn idle air screw in until lightly seated.
2. Back out as specified.

Air screw turns out:

IT250E....1.0

IT400E....2-1/4

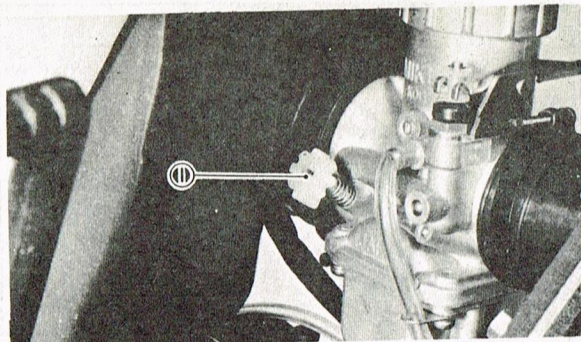

1. Pilot air screw

- Turn the idle speed adjusting screw until idle is at recommended rpm.

NOTE:

A lock nut is incorporated for positive retention of idle adjusting screw.

- Turn the idle air mixture screw in or out until idle speed is at highest rpm.
- Turn the idle speed adjusting screw in or out until idle speed is at desired rpm.

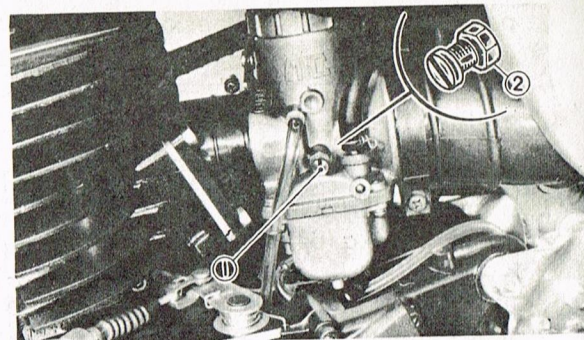

1. Throttle stop screw
2. Lock nut

NOTE:

Idle air mixture and idle speed adjustment screws should be so adjusted that engine response from idle position is rapid and without hesitation.

Idle air screw IT250E: 1.0
turns out: IT400E: 2-1/4

Idle speed: 1,300 ± 50 r/min

If the engine, when warm, hesitates after adjusting as described, turn the idle air mixture screw in or out in 1/4 turn increments until the problem is eliminated.

Spark plug

The spark plug in your machine indicates how the engine is operating. If the engine is operating correctly, and the machine is being ridden correctly, then the tip of the white insulator around the center electrode of the spark plug will be a medium to light tan color. If the porcelain is a very dark brown or black color, then a plug with a hotter heat range may be required.

This situation is quite common during the engine break-in period. However, use the standard plug. If the insulator tip shows a very light tan or white color or is actually pure white or if the electrodes show signs of melting, then a spark plug with a colder heat range is required.

Remember, the insulator must be a medium to-light tan color. If it is not, check carburetion, timing, and ignition adjustments. If the situation persists, consult your Authorized Yamaha Dealer.

Do not attempt to experiment with different heat range spark plugs. This takes an experienced eye, to gauge the proper spark plug heat range to use and to determine if the spark plug itself is at fault.

For normal operation use:

IT250E..... N-2G champion
IT400E..... N-3G champion

Spark plug gap: 0.7 mm (0.028 in)

Engine conditions will cause any spark plug to slowly break down and erode. If erosion begins to increase, or if the electrodes finally become too worn, or if for any reason you

believe the spark plug is not functioning correctly, replace it.

When installing the plug, always clean the gasket surface, use a new gasket, wipe off any grime that might be present on the surface of the spark plug, and torque the spark plug properly.

Spark plug torque: 2.5 m·kg (18 ft·lb)

The spark plug must be removed and checked prior to using the machine. Check electrode wear, insulator color, and electrode gap.

Ignition timing

Ignition timing must be set with a dial gauge (to determine piston position).

Proceed as follows:

1. Remove muffler, spark plug and screw Dial Gauge Stand into spark plug hole.
2. Insert Dial Gauge Assembly with a 56 mm (2.2 in) extension (needle) into stand.

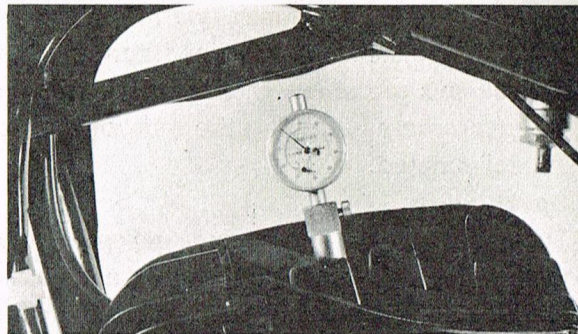

3. Remove left engine crankcase cover.
4. Rotate rotor until piston is at top-dead center (T.D.C.). Tighten set screw on dial gauge stand to secure dial gauge assembly. Set the zero on dial indicator face to line up exactly with dial indicator needle. Rotate flywheel back and forth to be sure that indicator needle does not go past zero.

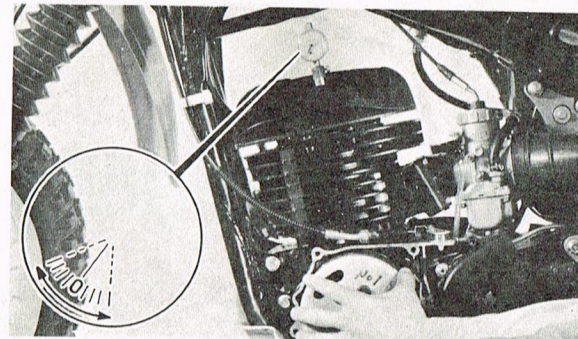

5. Starting at TDC, rotate flywheel clockwise until dial-gauge reads approximately 3 needle revolutions before-top-dead-center.
6. Slowly turn flywheel counter-clockwise until dial gauge reads ignition advance setting listed in specifications table.

Ignition timing (B.T.D.C.)

IT250E: 2.3 mm (0.091 in)

IT400E: 2.7 mm (0.106 in)

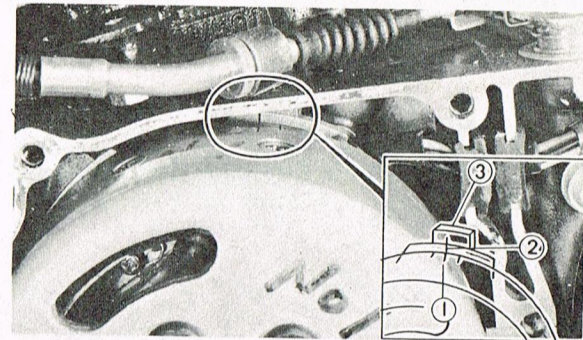

1. Flywheel mark
2. Base mark
3. Case mark

Then check the marks on the flywheel and crankcase for alignment. If they are not aligned or a new crankcase is used for replacement, punch a new mark on the crankcase matching the one on the flywheel.

NOTE:

Be sure to locate the position in the correct position before remarking.

7. Remove the flywheel.

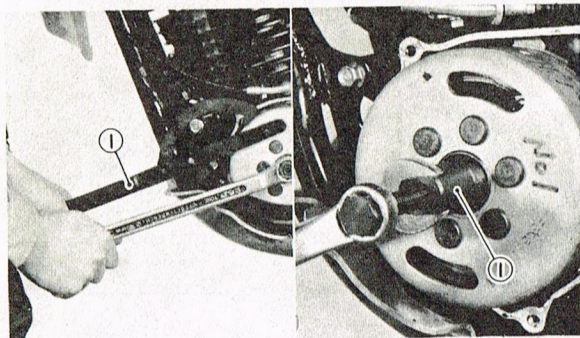

1. Flywheel holding tool
2. Flywheel puller

8. Check the alignment marks on the crankcase and base for alignment. If they are not aligned, loosen the base set screw until alignment is achieved.

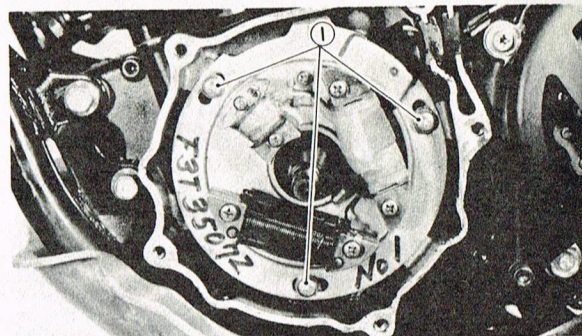

1. Base set screw

9. Remove dial gauge assembly and stand.
Reinstall spark plug:

Spark plug torque:
2.5 m-k (18 ft-lb)

Reinstall crankcase cover and muffler.

ENGINE MAINTENANCE AND MINOR REPAIRS

The following sections provide information for the disassembly, troubleshooting, and maintenance of various components of the machine. If you do not have the necessary tools and an understanding of the mechanical principles involved, please refrain from attempting repairs. The use of improper tools and/or procedures can cause major damage to units with resultant additional repair costs. To properly understand the procedures outlined, we suggest you consult other technical publications.

Finally, we suggest you consult Your Yamaha Dealer prior to attempting any repair procedures.

Air filter

Removal

1. Remove the screws and remove the right number plate.

2. Remove the Phillips-head screws (3) and remove filter case cover.

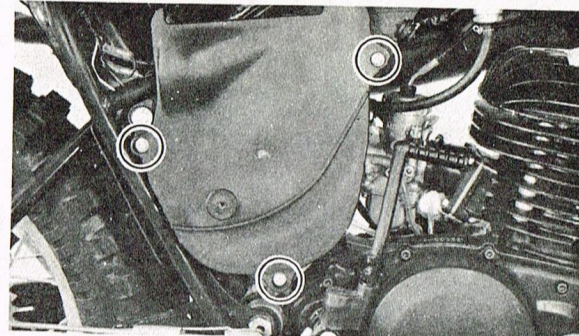

3. Remove the air filter from the filter case.
4. Slip the filter from the guide.

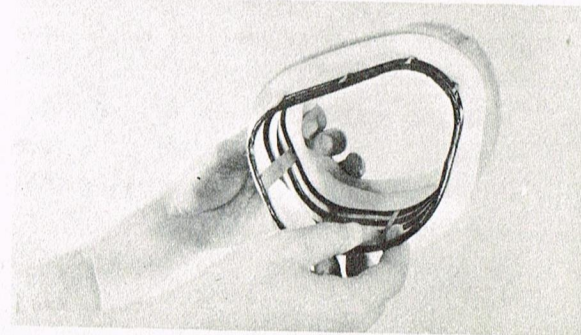

Cleaning method

1. Wash the element gently, but thoroughly, in solvent.
2. Squeeze the excess solvent out of the element and let dry.
3. Pour a small quantity of 30W motor oil onto the filter element and work thoroughly into the porous foam material.

NOTE:

In order to function properly, the element must be damp with oil at all times, but not dripping with oil.

4. Re-insert the filter element guide into the element.
5. Coat the sealing edges of the filter element with light grease. This will provide an airtight seal between the filter case cover and filter seat.

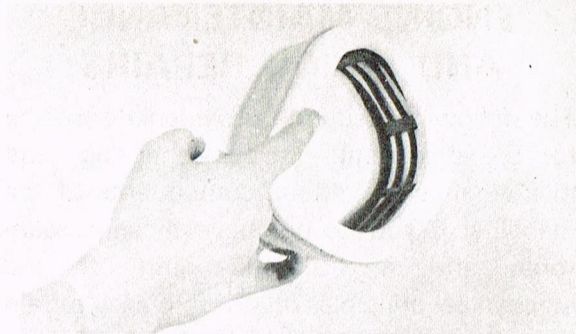

6. Reinstall the element assembly and parts removed for access.

NOTE:

Each time filter element maintenance is performed, check the air inlet to the filter case for obstructions. Check the air cleaner joint rubber to the carburetor and manifold fittings for an airtight seal. Tighten all fittings thoroughly to avoid the possibility of unfiltered air entering the engine.

CAUTION:

Never operate the engine with the air filter element removed. This will allow unfiltered air to enter, causing rapid wear and possible engine damage. Additionally, operation without the filter element will affect carburetor jetting with subsequent poor performance and possible engine overheating.

Carburetor

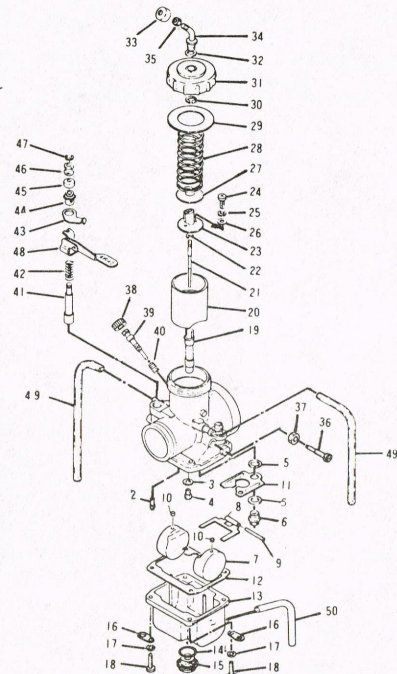

- | | |
|--------------------------|-----------------------------|
| 1. Carburetor ass'y | 26. Plate washer |
| 2. Pilot jet | 27. Seat |
| 3. Main jet washer | 28. Throttle valve spring |
| 4. Main jet | 29. Packing |
| 5. Valve seat washer | 30. Clip |
| 6. Valve seat ass'y | 31. Mixing chamber top |
| 7. Float | 32. Gasket |
| 8. Float arm | 33. Cap |
| 9. Float pin | 34. Wire guide tube |
| 10. Cap | 35. Wire adjusting nut |
| 11. Plate | 36. Throttle screw |
| 12. Float chamber gasket | 37. Lock nut |
| 13. Float chamber body | 38. Cap |
| 14. O-ring | 39. Air adjusting screw |
| 15. Screw plug | 40. Air adjusting spring |
| 16. Plate | 41. Starter plunger |
| 17. Spring washer | 42. Plunger spring |
| 18. Panhead screw | 43. Starter spring plate |
| 19. Main nozzle | 44. Plunger cap |
| 20. Throttle valve | 45. Cap |
| 21. Needle | 46. Starter plunger bushing |
| 22. Clip | 47. Circlip |
| 23. Connector | 48. Starter lever |
| 24. Panhead screw | 49. Air vent pipe |
| 25. Spring washer | 50. Overflow pipe |

Replacement of main jet

1. Turn fuel petcock lever to the "OFF" position.
2. Remove the gasoline tank fuel line into from the fitting at the carburetor.
3. Loosen the manifold and inlet joint bands (hose clamps).

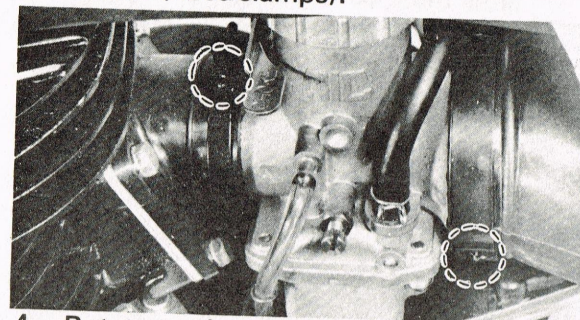

4. Rotate carburetor, exposing main jet cover bolt.
5. Remove bolt. Main jet is located directly behind bolt.

—WARNING:
Removing the main jet cover bolt will allow the fuel in the float bowl to

drain. Do not remove if engine is hot. Place a rag under carburetor to catch overflow. Remove bolt in well-ventilated area. Do not remove near open flame. Always clean and dry machine after reassembly.

6. Remove the main jet. Change as required. Reinstall cover bolt and reassemble, reversing steps 1 through 3.

Main jet: IT250E..... # 360
IT400E..... # 350

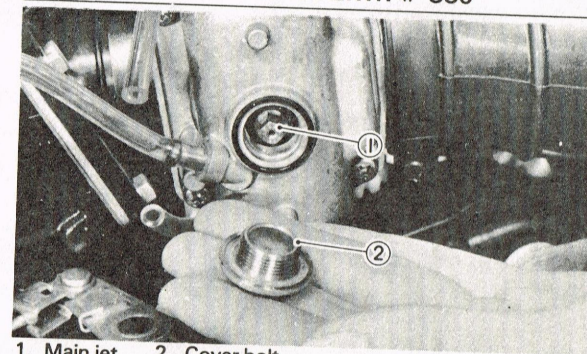

1. Main jet 2. Cover bolt

Inspection

1. Examine carburetor body and fuel passages. If contaminated, wash carburetor in petroleum based solvent. Do not use caustic carburetor cleaning solutions. Blow out all passages and jets with compressed air.
2. Examine condition of floats. If floats are leaking or damaged, they should be replaced.
3. Inspect inlet needle valve and seat for wear or contamination. Replace these components as a set.

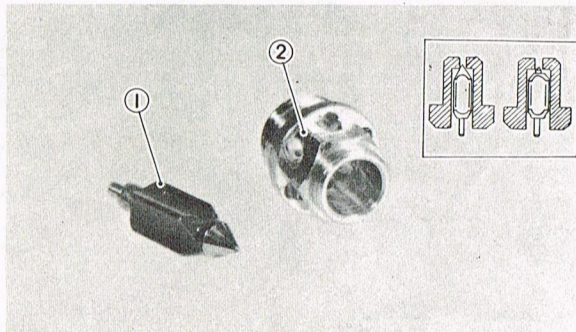

1. Float valve 2. Valve seat

Adjustments

1. Float level

Measure the distance from the float arm to the float bowl gasket surface. Bend the tang on the float arm if any float level adjustment is necessary. Both float arms must be at the same height. If the float level is too high, a lean air/fuel mixture will occur. If too low, a rich mixture will result.

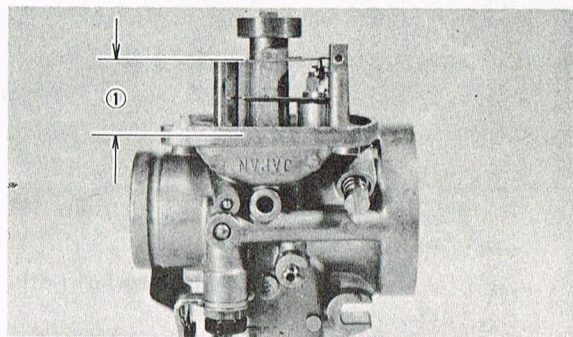

1. Float level

Float level: 18.1 ± 1 mm

2. Jet needle

The mid-range air/fuel supply is affected by the position of the needle in the needle jet. If it is necessary to alter the mid-range air/fuel mixture characteristics of the machine, the jet needle position may be changed. Move the jet needle up for a leaner condition or toward the bottom position for a richer condition.

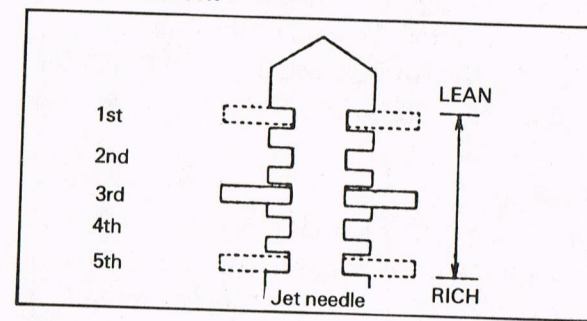

Troubleshooting

A Motocross machine requires immediate, predictable throttle response over a wide

operating range. Cylinder porting, combustion chamber compression, ignition timing, muffler design, and carburetor size and component selection are all balanced to achieve this goal. However, variations in temperature, humidity and altitude will affect carburetion and consequently, engine performance.

The following list gives each of the major components of the carburetor that can be readily changed in order to modify performance if required. If you are unfamiliar with carburetor theory, we suggest you refrain from making changes. Quite often, a performance problem is caused by another related component, such as the exhaust system, ignition timing or combustion chamber compression.

NOTE: See MECHANICAL ADJUSTMENTS for additional carburetor adjustments.

Idle air mixture screw:

Controls the ratio of air-to-fuel in the idle circuit. Turning the screw in decreases the air supply, giving a richer mixture.

OPERATING RANGE MOST AFFECTED BY THIS ADJUSTMENT: ZERO TO 1/8 THROTTLE.

Pilot jet:

Controls the ratio of fuel-to-air in the idle circuit. Changing the jet to one with a higher number supplies more fuel to the circuit giving a richer mixture.

OPERATING RANGE MOST AFFECTED BY THIS JET: ZERO TO 1/8 THROTTLE.

Throttle valve (slide):

The throttle valve (slide) has a portion of the base cut away to control air flowing over the main nozzle. A wider angle (more "cutaway" will create a leaner mixture. Throttle valves are numbered according to the angle of the cutaway. The higher the number, the more cutaway, the leaner the mixture.

OPERATING RANGE MOST AFFECTED BY THE THROTTLE VALVE: 1/8 to 1/4 (+) THROTTLE.

Jet needle:

The jet needle is fitted within the throttle valve. The tapered end of the needle fits into the main nozzle outlet. Raising the needle allows more fuel to flow out of the needle. Moving the needle clip from the first, or top groove, through the fifth, or bottom groove, will give a correspondingly richer mixture.

OPERATING RANGE MOST AFFECTED BY THE JET NEEDLE: 1/4 to 3/4 (+) THROTTLE.

Main jet:

The main jet controls overall fuel flow through the main nozzle. Changing the jet to one with a higher number supplies more fuel to the main nozzle giving a richer mixture.

OPERATING RANGE MOST AFFECTED BY THE MAIN JET: 3/4 TO FULL THROTTLE.

NOTE:

Excessive change in main jet size can affect performance at all throttle positions.

CAUTION:

The fuel/air mixture ratio is a governing factor upon engine operating temperature. Any carburetor changes, whatsoever, must be followed by a thorough spark plug test.

Reed valve

1. With carburetor removed, remove the four bolts holding the intake manifold and reed valve assembly to the cylinder. Remove the reed valve assembly.

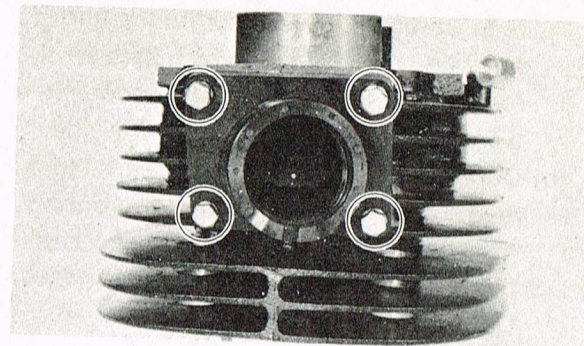

2. Inspect reed petals for signs of fatigue cracks. Reed petals should fit flush or nearly flush against neoprene seats. If in doubt as to sealing ability, apply suction to carburetor side of assembly. Leakage should be slight to moderate.
3. If disassembly of the reed valve assembly is required, proceed as follows:
 - a. Remove philips screws (2) securing stopper plate and reed to block. Handle

reed carefully. Avoid scratches and do not bend. Note from which side of the reed block the reed and stopper plate were removed. Reinstall on same side.

- b. During reassembly, clean reed block, reed, and stopper plate thoroughly. Apply a holding agent, such as "Lock-Tite," to threads of philips screws. Tighten screws gradually to avoid warping, then tighten the screws thoroughly.

CAUTION:
Do not over-tighten securing screws or stopper plates may warp.

Securing screw torque:
8.0 cm-kg (6.9 in-lb)

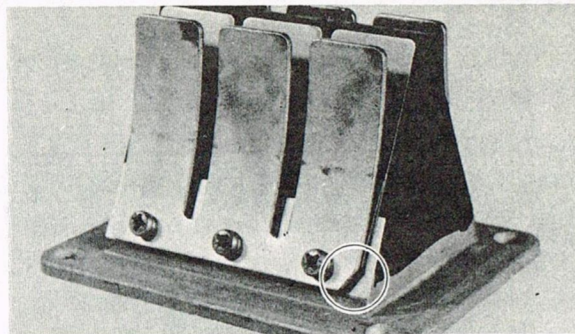

NOTE:
During reassembly, observe the cut in the lower corner of the reed and stopper plate. Use as aid to direction of reed installation.

4. During reassembly of the reed valve assembly and manifold, install new gaskets and torque the securing bolts gradually and in pattern.

MUFFLER AND CYLINDER HEAD REMOVAL (Carburetor Removed)

1. Remove the left side cover.
2. Remove the coil springs at muffler to cylinder joint.
3. Remove the muffler mounting bolts and loosen the muffler joint screws. And remove clutch wire.

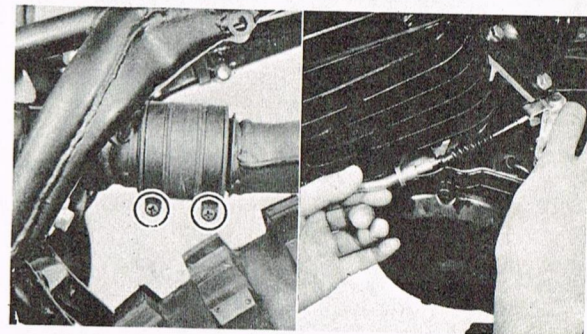
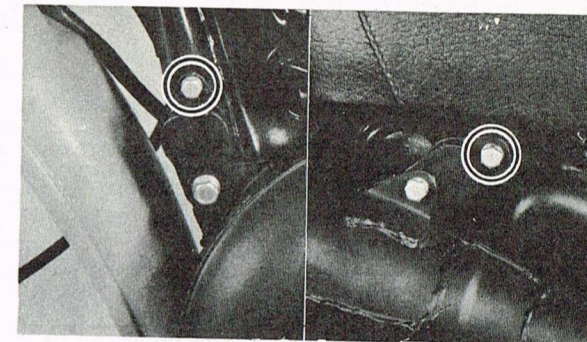
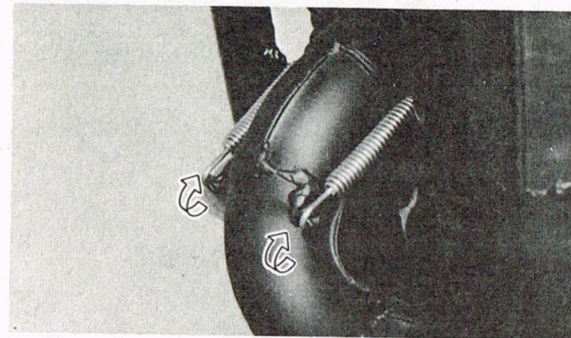

4. Remove nuts securing cylinder and head, 6 nuts. Remove cylinder head and gasket.

NOTE: _____
Break each nut loose (1/4 turn) prior to removing.

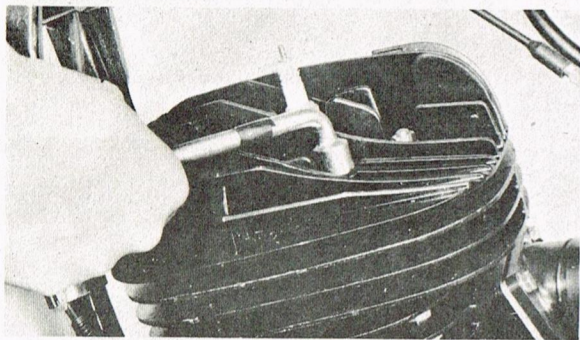

CYLINDER AND PISTON REMOVAL

1. Remove the cylinder holding nuts.

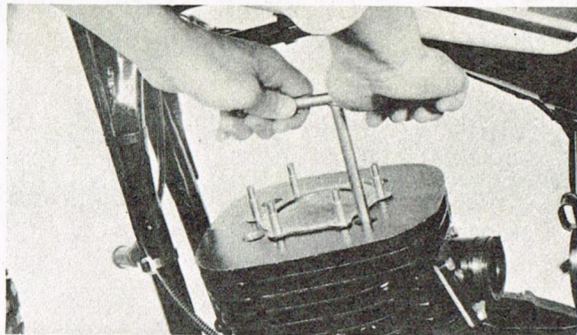

2. With the piston at top dead center, raise the cylinder until the cylinder skirts clear crankcase. Stuff a clean shop rag into crankcase cavity, around rod, to prevent dirt and other foreign particles from entering. Remove cylinder and base gasket.
3. Remove the wrist pin clip (1) from the piston. Push the wrist pin out from opposite side. Remove the piston and small end bearing.

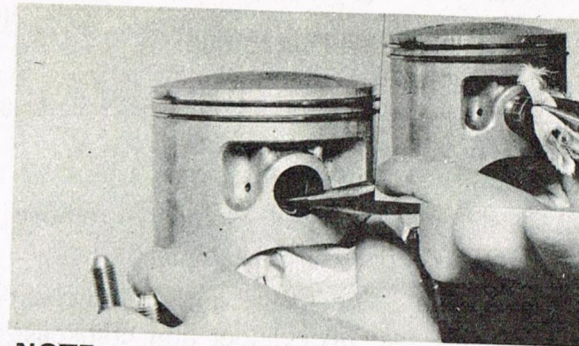

NOTE: _____
If the pin hangs up, use a wrist pin puller. Do not pound on pin as damage to rod, piston and bearing will result.

MAINTENANCE - EXHAUST PIPE

1. Using a rounded scraper, remove excess carbon deposits from manifold area of exhaust pipe. Check muffler gasket condition. The gasket seat is located around the cylinder exhaust port.
2. Carbon deposits within the silencer may be removed by lightly tapping the outer

shell with a hammer and then blowing out with compressed air. Heavy wire, such as a coat hanger, may be inserted to break loose deposits. Use care.

3. Reinstall muffler. MAINTENANCE - CYLINDER HEAD

1. Remove spark plug.
2. Using a rounded scraper, remove carbon deposits from combustion chamber. Take care to avoid damaging the spark plug threads. Do not use a sharp instrument.

Avoid scratching the metal surface.

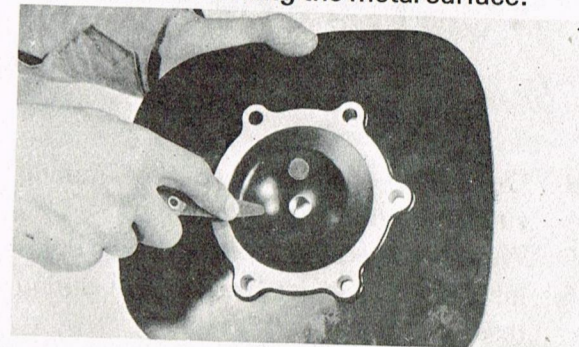

- Place the head on a surface plate. There should be no warpage. Correct by resurfacing. Place 400-600 grit wet emery sandpaper on surface plate and re-surface head using a figure-eight sanding pattern. Rotate head several times to avoid removing too much material from one side.

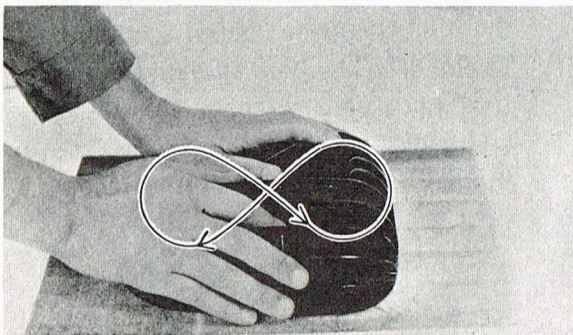

- Clean the spark plug gasket mating surface thoroughly.
- Wash the head in solvent and wipe dry.
- Install new cylinder head gasket during reassembly.

Cylinder head nut torque:
2.5 m-kg (18.0 ft-lb)

MAINTENANCE - CYLINDER

- Remove reed valve assembly.
- Using a rounded scraper, remove carbon deposits from exhaust port.
- Remove cylinder base gasket and clean gasket seat on cylinder and crankcase thoroughly.
- Check cylinder bore. Using a cylinder gauge set to standard bore size,

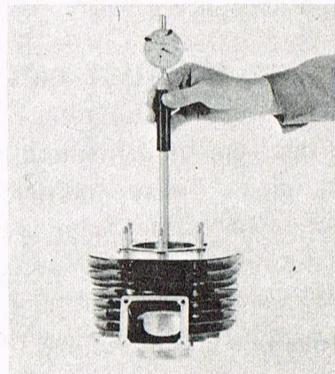

measure the cylinder. Measure at six points; at top, center, and from bottom of piston, in line with the wrist pin and at right angle to pin. Compare to piston a measurements. If over tolerance, and not correctable by honing, rebore to next over-size.

Standard bore size:
IT250E 70.00 mm (2.76 in)
IT400E 85.00 mm (3.35 in)

- Clean cylinder in solvent, then wash with hot soapy water. Dry. Coat walls with light of film.
- During re-assembly, always use a new cylinder base gasket.

Cylinder holding nut torque:
3.5 m-kg (25.2 ft-lb)

Maintenance - Piston

- Using a rounded scraper, remove carbon deposits from piston crown.
- Break a used piston ring in two. File end square. De-burr edges to avoid scratching ring groove and clean carbon deposits from ring groove.
- Using 400 - 600 grit wet sandpaper, lightly sand score marks and lacquer deposits from sides of piston. Sand in cross-hatch pattern. Do not sand excessively.

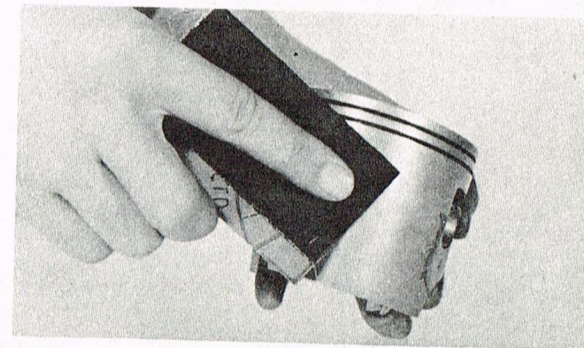

4. Wash piston in solvent and wipe dry.
5. Using an outside micrometer, measure piston diameter. The piston is camground and tapered. The only measuring point is at right-angles to the piston pin holes, 10 mm (0.4 in) from the bottom of the piston skirts. Compare piston diameter to cylinder bore measurements (bottom two measurements at right angles to piston pin line).

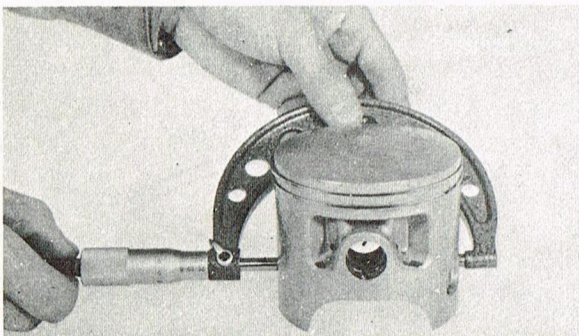

$$\text{Piston clearance} = \text{Minimum cylinder dia.} - \text{Maximum piston dia.}$$

If beyond tolerance, replace piston or rebore cylinder as required.

$$\text{Nominal piston clearance: } 0.045 - 0.050 \text{ mm (0.0018 - 0.0020 in)}$$

$$\text{Maximum wear limit: } 0.1 \text{ mm (0.0039 in)}$$

6. During re-assembly, coat the piston skirt areas liberally with two-stroke oil.
7. Install new piston pin circlips and make sure they are fully seated within their grooves.
8. Take care during installation to avoid damaging the piston skirts against the crankcase as the cylinder is installed.

NOTE: _____
The arrow on piston dome must face forward.

9. Make sure the ring is properly seated as the cylinder is installed.

PISTON RINGS

1. Insert ring into cylinder. Push down approximately 20 mm (0.79 in) using piston crown to maintain right angle to bore. Measure installed end gap. If beyond tolerance, replace ring.

$$\text{Ring end gap, installed (Top and second)} \\ 0.3 - 0.5 \text{ mm (0.012 - 0.020 in)}$$

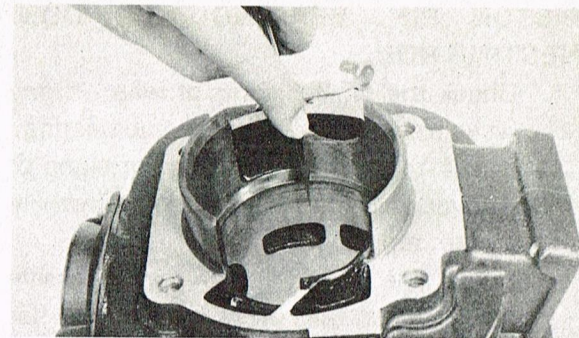

2. Holding cylinder towards light, check for full seating of ring around bore. If not fully seated, check cylinder. If cylinder is not out-of-round, replace ring.
3. During installation, make sure ring ends are properly fitted around ring location pin in piston groove. Apply liberal coating of two-stroke oil to ring.

NOTE: _____
New ring requires break-in. Follow first portion of new machine break-in procedure.

PISTON PIN, BEARING AND CONNECTING ROD

1. Check the pin for signs of wear. If any wear is evident, replace pin and bearing.
2. Check the pin and bearing for signs of heat discoloration. If excessive (heavily blued), replace both.
3. Check the bearing cage for excessive wear. Check the rollers for signs of flat spots. If found, replace pin and bearing.
4. Apply a light film of oil to pin and bearing surfaces. Install in connecting rod small end.

Check for play. There should be no noticeable vertical play. If play exists, check connecting rod small end diameter and wear. Replace pin and bearing or all as required.

5. Mount the dial gauge at right angles to the connecting rod small end, holding the bottom of rod toward the dial indicator. Rock top of rod and measure axial play.

Connecting rod axial play:
0.4 - 0.2 mm (0.016 - 0.079 in)

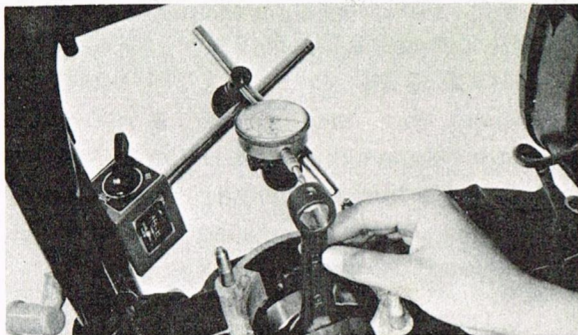

6. Remove the dial gauge and slide the connecting rod to one side. Insert a thickness gauge between the side of the connecting rod big end and the crank wheel. Measure clearance.

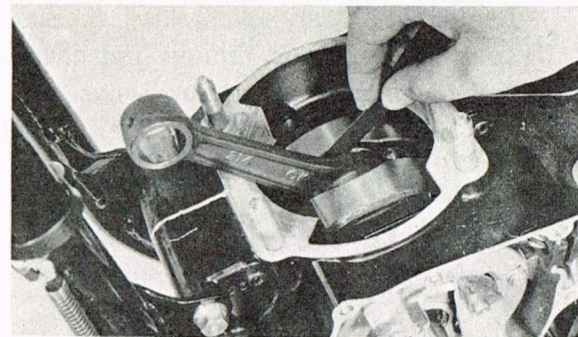

Connecting rod/crank side clearance:
0.25 - 0.75 mm (0.01 - 0.030 in)

7. If any of the above measurements exceed tolerance, crankshaft repair is required. Take the machine to your Authorized Yamaha Dealer.
8. During reassembly, apply a liberal coating of two-stroke oil to the piston pin and bearing. Apply several drops of oil to the connecting rod big end. Apply several drops of oil into each crankshaft bearing oil delivery hole.

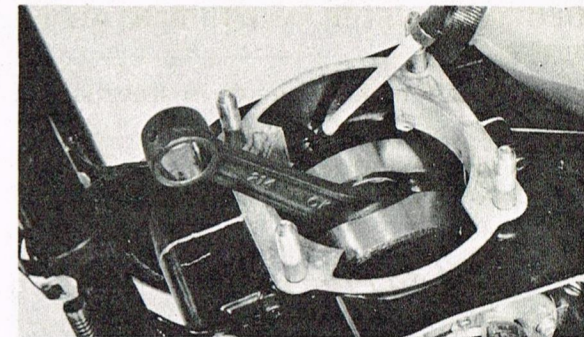

TROUBLESHOOTING - TOP END AND MUFFLER

The following procedure will indicate if top end disassembly is required.

1. Make a spark plug reading. Adjust spark plug and of carburetion as required.
2. Decarbonize muffler/spark arrester assembly. Remove cylinder head and make thorough visual inspection. Decarbonize cylinder head and piston crown. Take care that carbon does not drop into crankcase cavity or foul ring grooves. Reassembly.

CLUTCH, SHIFTER, AND KICK STARTER

NOTE:

Clutch adjustment is covered in "Mechanical Adjustments".

Kick starter and crankcase cover (R) removal

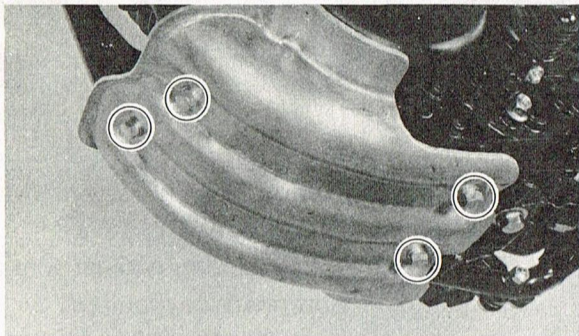

1. Remove the engine protector.
2. Remove the filler plug and drain plug, and drain the transmission oil.
3. Remove the rear brake rod. Remove footrest and brake pedal. Remove the kick starter crank.

4. Remove the Allen bolts holding the side cover in place and remove the cover. Note the position of the dowel pins.

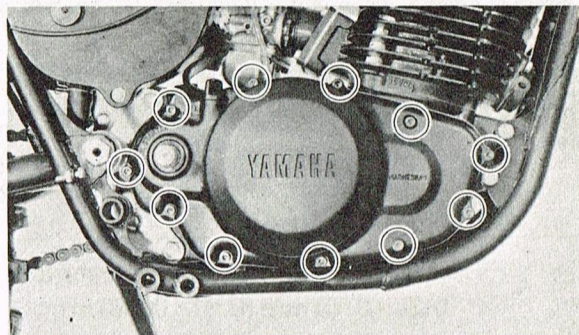

Clutch and kick assembly removal

1. Repeat steps Kick starter and crankcase cover (R) removal.
2. Remove the hexagon head screws holding the pressure plate. Remove the clutch springs, pressure plate and push rod 1. Remove the clutch plates and friction plates.

NOTE:

When removing hexagon head screw, loosen each screw in several stages, working in a crisscross pattern, to avoid any unnecessary warpage. Note the condition of each piece as it is removed and its location within the assembly.

3. Bend lock washer tab down. Using the clutch holding tool, remove the clutch securing nut and lock washer.
4. Remove the clutch boss and driven gear (clutch housing).

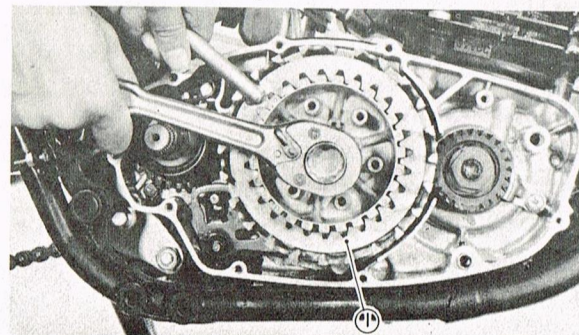

1. Clutch holding tool

5. If the clutch housing spacer remains on the transmission main shaft, remove it. Remove the thrust plate and thrust plate spacers.
6. Remove the circlip and then remove kick idle gear.

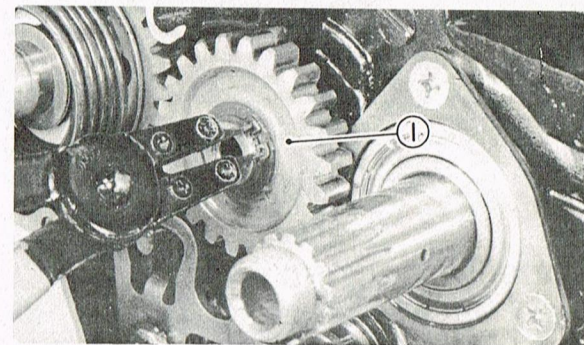

1. Kick idle gear

7. Unhook the kick spring from its post in the crankcase. Allow it to relax. Then remove the kick axle assembly by rotating the shaft counterclockwise and then pulling out the entire assembly.

Check to see that the kick gear spirals freely on the worm shaft. Check the gear teeth for wear and breakage.

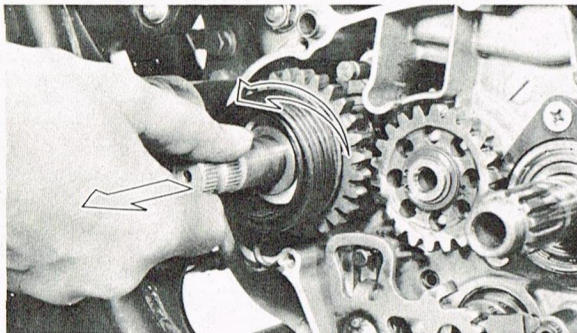

TROUBLESHOOTING-CLUTCH ASSEMBLY

1. Measure the friction plates at three or four points. If their minimum thickness exceeds tolerance, replace all plates.

	New	Wear Limit
Friction plate thickness	3.0 mm (0.12 in)	2.7 mm (0.11 in)

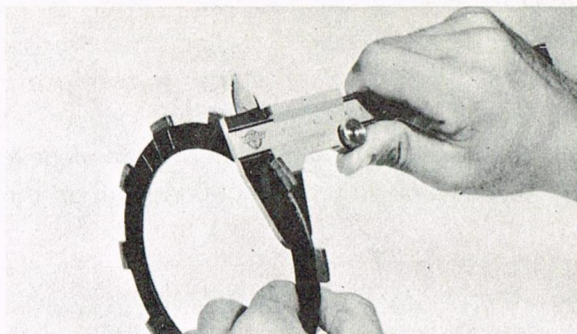

2. Check the plates for signs of warpage and heat damage, replace as required.

NOTE:

For optimum performance, if any plate requires replacement, it is advisable to replace the entire set.

3. Check each clutch plate for signs of heat damage and warpage. Place on surface plate (plate glass is acceptable) and use feeler gauge.

Clutch plate warp allowance:
0.05 mm (0.002 in)

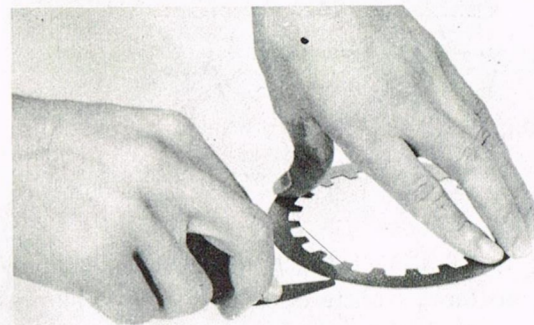

4. Thoroughly clean the clutch housing and spacer. Apply a light film of oil on the bushing surface and spacer. Fit the spacer into the bushing. It should be a smooth, thumb-press fit. The spacer should rotate smoothly within the bushing. If necessary, replace spacer or clutch housing.

5. Check the bushing and spacer for signs of galling, heat damage, etc. If severe, replace as required.
6. Apply thin coat of oil to transmission main shaft and bushing spacer I.D. Slip spacer over main shaft. Spacer should fit with approximately same "feel" as in clutch housing. Replace as required.
7. Check dogs on driven gear (clutch housing). Look for cracks and signs of galling on edges. If moderate, deburr. If severe, replace.
8. Check splines on clutch boss for signs of galling. If moderate, deburr. If severe, replace.

NOTE:

Galling on either the friction plate dogs of the clutch housing or clutch plate splines of the clutch boss will cause erratic clutch operation.

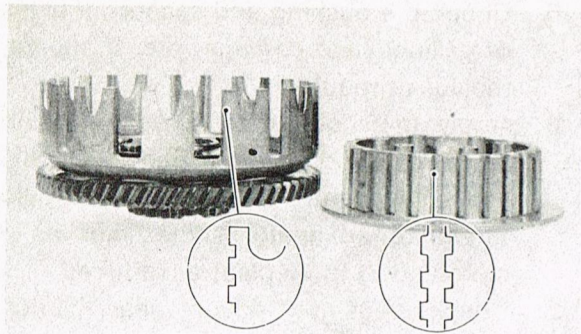

9. Fit the clutch thrust plate with a light film of oil on all parts. Check for smooth rotation. Check for signs of excessive wear, all parts. Replace as necessary.
10. Measure each clutch spring. If beyond tolerance, replace.

	New	Minimum
Clutch spring free length	36 mm (1.42 in)	35 mm (1.38 in)

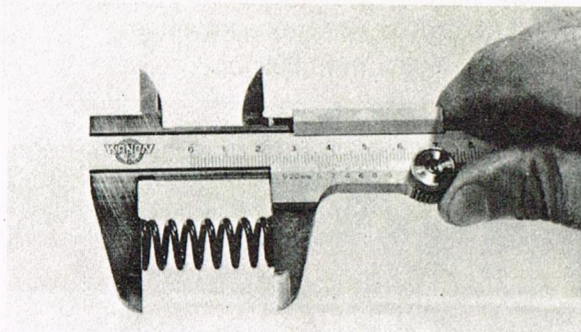

11. Stack the clutch spring set on a level surface. Rotate each spring until all are at approximately the same vertical angle and maximum apparent height. Place straightedge across set. If any spring exceeds tolerance, it is advisable to replace the clutch springs as a set.
12. Before installation, apply grease to push rod 1 and ball.

SHIFT MECHANISM

During installation, match the index mark on change lever 2 and center of change lever 1. Align.

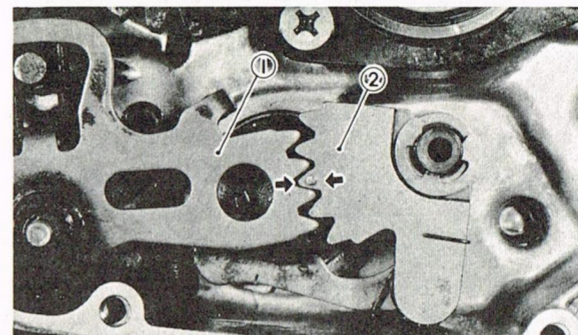

1. Change lever 1
2. Change lever 2

Clutch

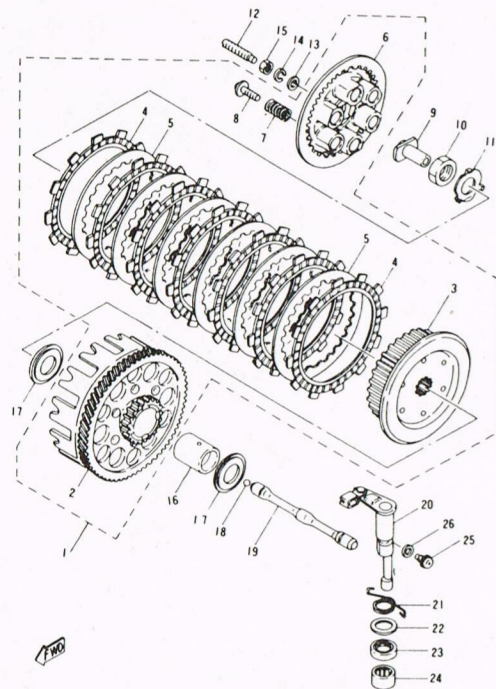

1. Clutch ass'y
2. Primary driven gear comp
3. Boss, clutch
4. Friction plate
5. Clutch plate
6. Pressure plate
7. Compression spring
8. Screw with washer
9. Push rod 1
10. Nut
11. Lock washer
12. Screw
13. Plain washer
14. Spring washer
15. Hexagon nut
16. Spacer
17. Thrust plate
18. Ball
19. Push rod
20. Push lever ass'y
21. Torsion spring
22. Plate washer
23. Oil seal
24. Bearing
25. Screw
26. Gasket

CHASSIS MAINTENANCE AND MINOR REPAIRS

SPROCKETS AND CHAIN

NOTE:

Please refer to Maintenance Intervals and Lubrication Intervals charts.

Drive sprocket

1. Check sprocket wear. Replace if wear decreases tooth height to a point approaching the roller center line.
2. Replace if tooth wear shows a pattern such as that in the illustration, or as precaution and common sense dictate.

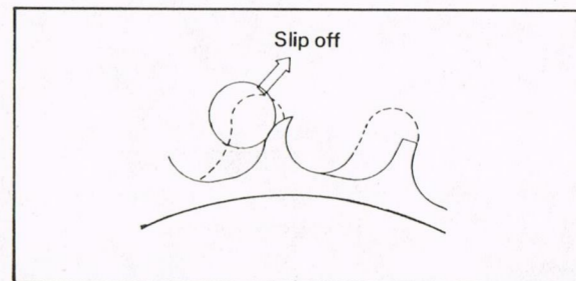

3. During drive sprocket reassembly, make sure the lock washer splines are properly seated on the drive shaft splines. Tighten securing nut thoroughly to specified torque value. Bend lock washer tab fully against securing nut flat.

Drive sprocket securing nut torque:
7.5 m-kg (54 ft-lb)

Driven sprocket

1. Check the sprocket to see that it runs. Do not heat and hammer to straighten. Use a press. If severely bent, replace.

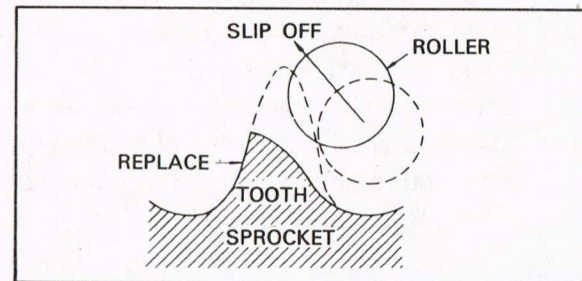

2. During reassembly, make sure the sprocket and sprocket seat are clean. Tighten the securing bolts in a crisscross pattern. Bend the tabs of the lock washers fully against the securing bolt flats.

Driven sprocket securing nut torque:
2.5 m-kg (18 ft-lb)

Chain

1. Check the chain for stiffness. Hold as illustrated. If stiff, soak in solvent solution, clean with medium bristle brush, dry with high pressure air. Oil chain thoroughly and attempt to work out kinks. If still stiff, replace.
2. Check the side plates for visible wear. Check to see if excessive play exists in pins and rollers. Check for damaged rollers. Replace as required.

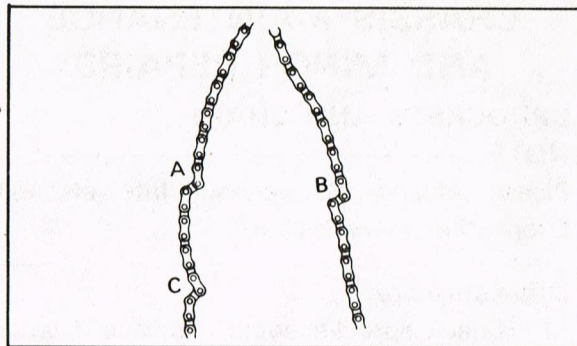

3. During reassembly, the master link clip must be installed with the rounded end facing the direction of travel.

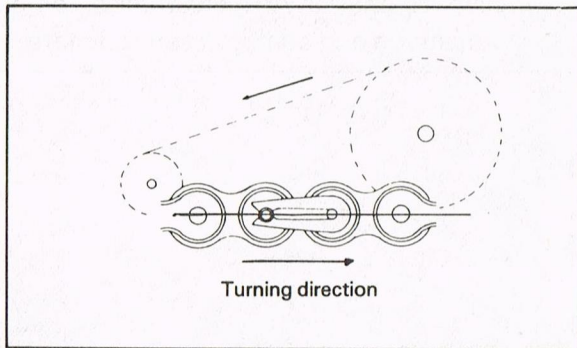

Troubleshooting

With the chain installed on the machine, excessive wear may be roughly determined by attempting to pull the chain away from the rear sprocket. If the chain will lift away more than one-half the length of the sprocket teeth, remove and inspect. If any portion of the chain shows signs of damage, or if either sprocket shows signs of excessive wear, remove and inspect.

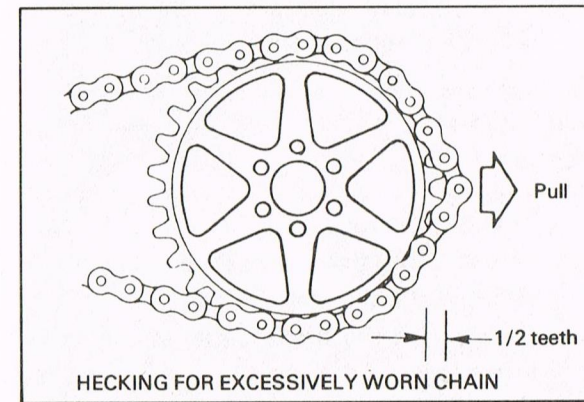

Maintenance

The chain should be lubricated after every use of the machine.

1. Wipe off dirt with shop rag. If accumulation is severe, use wire brush, then rag.
2. Apply lubricant between roller and side plates on both inside and outside of chain. Don't skip a portion as this will cause uneven wear. Apply thoroughly. Wipe off excess.

NOTE:

Chain and lubricant should be at room temperature to assure penetration of lubricant into rollers.

3. Periodically, remove the chain, wipe and/or brush excess dirt off. Blow off with high pressure air.

- Soak chain in solvent, brushing off remaining dirt. Dry with high pressure air. Lubricate thoroughly while off machine. Work each roller thoroughly to make sure lubricant penetrates. Wipe off excess. Re-install.

NOTE: _____
See Maintenance and Lubrication Schedule Charts for additional information.

Cables

Cable maintenance is primarily concerned with preventing deterioration through rust and weathering; and providing for proper lubrication to allow the cable to move freely within its housing.

Cable removal is straightforward and uncomplicated. Removal will not be discussed within this section. For details, see the individual maintenance section for which the cable is an integral part.

Maintenance

- Remove the cable.
- Check for free movement of the cable with its housing. If movement is obstructed, check for fraying of the cable strands. If fraying is evident, replace the cable assembly.
- To lubricate cable, hold in vertical position. Apply lubricant to uppermost end of cable. Leave in vertical position until lubricant appears at bottom end. Allow excess to drain and reinstall.

Use Yamaha Chain and Cable Spray lubricant.

Front wheel removal

- Elevate the front wheel by placing a suitable stand under the engine.
- Disconnect the brake cable at the front brake lever.
- Remove the cotter pin and front wheel axle nut.

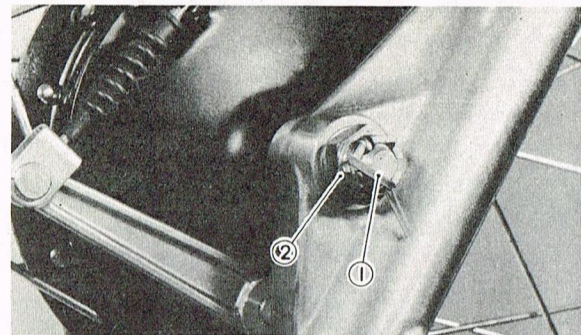

1. Cotter pin
2. Axle nut

- Turn and pull out the front wheel axle; the wheel assembly can be removed.

Rear wheel removal

- Elevate the rear wheel by placing a suitable stand under the engine.
- Remove the brake rod from the cam lever by compressing the rod's spring seat. Then hold it up and place rod on the hook of the rear arm.

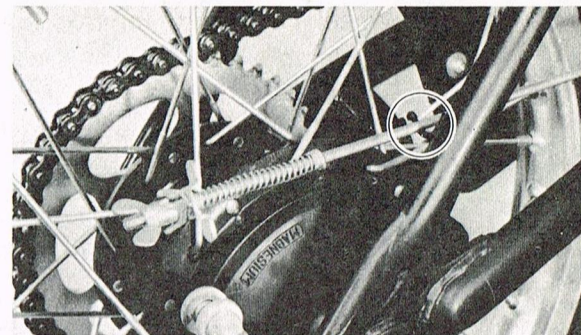

- Loosen the axle nut and remove chain.
- Remove the cotter pins (left and right) from clevis pins. Then remove the clevis pins.

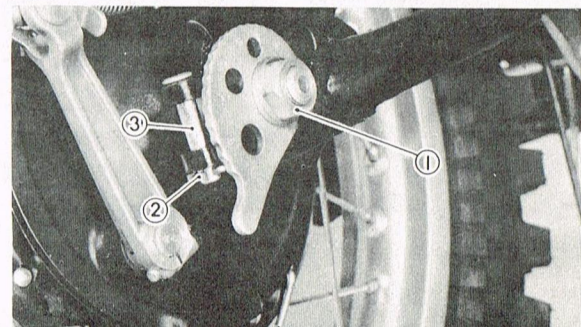

1. Axle nut 2. Cotter pin 3. Clevis pin

5. Pull the wheel backward, remove the rear wheel assembly.

Wheels installation

When installing wheels, reverse the removal procedure, taking care of the following points:

1. Check for proper engagement of the boss on the outer tube (or swing arm) with the locating slot on the brake shoe plate.

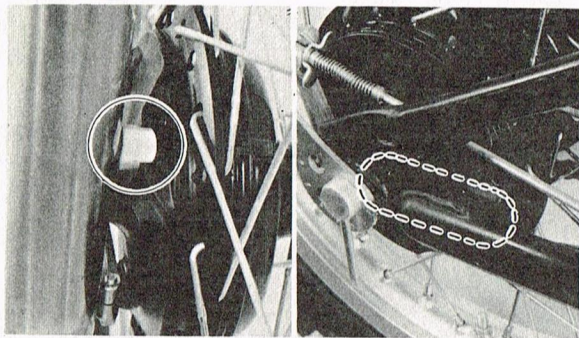

2. Make sure the axle nuts are properly tightened.

Axle nut torque: 9 m-kg (65 ft-lb)

3. Always use new cotter pins.
4. Adjust the play in the brake lever and pedal.
5. When connecting the chain, make certain closed end of master link clip is facing direction of rotation.

Checking brake shoe wear

Measure the outside diameter at the brake shoe with slide calipers. If it measures less than specified limit replace brake shoes.

Minimum brake lining thickness: 2 mm

	Brake shoe dia.	Wear limit
Front	130 mm (5.12 in)	126 mm (4.96 in)
Rear	160 mm (6.30 in)	156 mm (6.14 in)

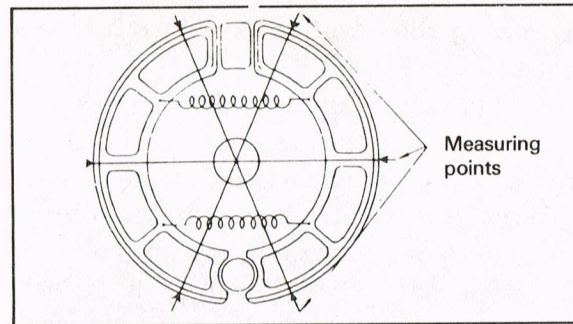

Brake drum

Oil or scratches on the inner surface of the brake drum will impair braking performance or result in abnormal noises. Remove oil by wiping with a rag soaked in lacquer thinner or solvent. Remove scratches by lightly and evenly rubbing with emery cloth.

Replacing wheel bearings

If the bearings allow excessive play in the wheel or if it does not turn smoothly have your dealer replace the wheel bearings. Bearing replacement requires the use of special tools and should be done by a Yamaha dealer.

Spokes

check the spokes. If they are loose or bent, tighten or replace them. The spokes should be checked before each use.

Tire removal

1. Remove valve cap, valve core, valve stem lock nut, and rim lock nuts.
2. When all air is out of tube, separate tire bead from rim (both sides) by stepping on tire with your foot.
3. Use two tire removal irons (with rounded edges) and begin to work the tire bead over the edge of the rim, starting 180° opposite the tube stem. Take care to avoid pinching the tube as you do this.
4. After you have worked one side of the tire completely off the rim, then you can slip the tube out. Be very careful not to damage the stem while pushing it back out to the rim hole.

NOTE: _____

If you are changing the tire itself, then finish the removal by working the tire off the same rim edge.

Installing tire

Re-installing the tire assembly can be accomplished by reversing the disassembly procedure. The only difference in procedure would be right after the tube has been installed, but before the tire has been completely slipped onto the rim. Inflate the tube. This removes any creases that might exist. Release the air and continue with reassembly. Also, right after the tire has been completely slipped onto the rim, check to make sure that the stem is squarely in the center of the hole in the rim.

Tire pressure:

Front 0.9 kg/cm² (13 lb/in²)

Rear 1.1 kg/cm² (15 lb/in²)

Checking rims and spokes (Front & rear wheels)

1. Checking for loose spokes

Loose spokes can be checked by bracing the machine off the ground so that the front wheel can spin freely. Slowly rotate the front wheel and at the same time let the metal shaft of fairly heavy screwdriver bounce off each spoke. If all the spokes are tightened approximately the same then the sound given off by the screwdriver hitting the spokes should sound the same. If one spoke makes a dull flat sound, then check it for looseness.

2. Checking rim "run-out"

While you have the machine up, check the front wheel run-out. "Run-out" is the amount the front wheel deviates from a straight line as it spins. Secure the front forks to keep them from turning. Set up a dial indicator or solidly

anchor a pointer about 3 mm (0.12 in) away from the side of the rim. As the wheel spins, the distance between the pointer and the rim should not change more than 2 mm (0.079 in) total. Any greater fluctuation means that you should remove this rim warpage by properly adjusting the spokes.

Run-out limits: 2 mm (0.079 in)

FRONT FORKS AND STEERING HEAD

Front fork oil charge

1. With the front wheel removed or raised off the floor with a suitable frame stand, remove cap bolts on inner fork tubes.
2. Remove drain screw from each outer tube with open container under each drain hole.

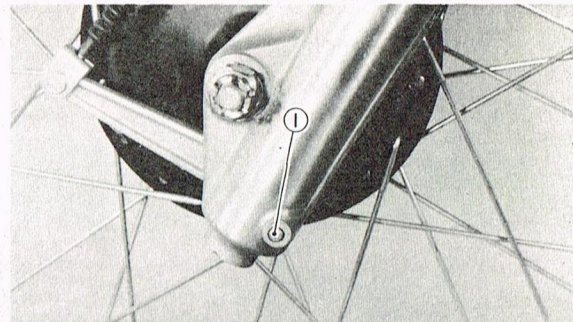

1. Drain screw

3. After most of oil has drained, slowly raise and lower outer tubes to pump out remaining oil.
 4. Replace drain screw.
- NOTE:** _____
Check gaskets, replace if damaged.
5. Measure correct amount of oil and pour into each leg.

Recommended oil:

Yamaha fork oil 20W

Quantity per leg:
250 cc (8.45 oz)

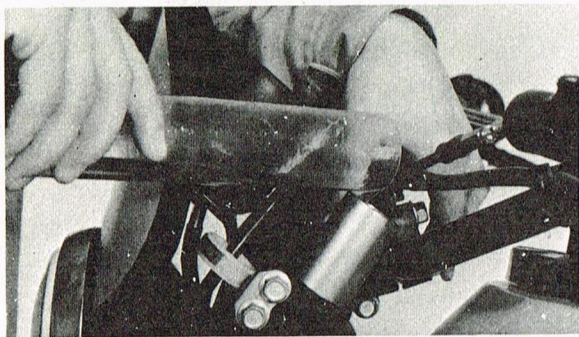

6. After filling, slowly pump the outer tubes up and down to distribute the oil.
7. Inspect O-ring on fork cap bolts and replace if damaged.

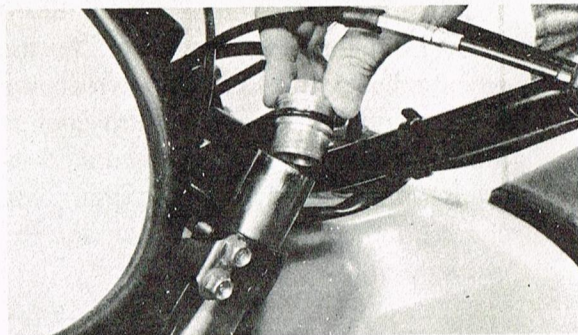

8. Replace fork cap bolts and torque to specification.

Fork cap bolt torque:
2.5 m-k (18 ft-lb)

Steering head adjustment

1. With front wheel elevated, grasp bottoms of fork legs and gently push and pull to check steering head freeplay. There should be no noticeable freeplay.

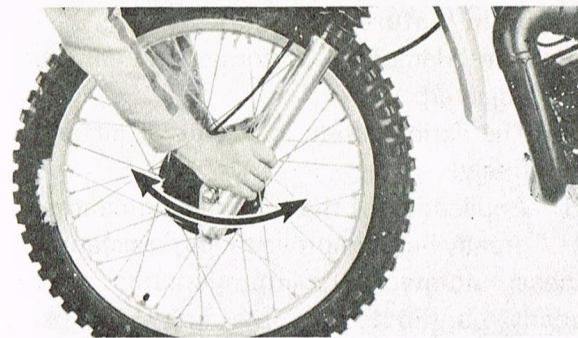

2. To adjust, first loosen upper stem pinch bolt.
3. Loosen stem bolt.
4. Use ring nut wrench to tighten adjust nut. Tighten until freeplay is eliminated.

CAUTION:
Forks must swing from lock to lock without binding or catching.

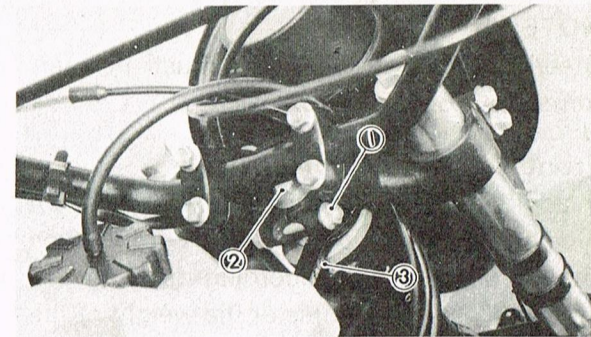

1. Pinch bolt 2. Stem bolt 3. Ring nut wrench

5. Tighten stem bolt and torque to specification.

Stem bolt torque:
6.0 m-k (43.2 ft-lb)

6. Tighten pinch bolts at fork crown and torque to specification.



Stem pinch bolt torque:
1.5 m-k (10.8 ft-lb)

NOTE:

Steering head disassembly must be performed by your Yamaha dealer.

Front fork spring replacement

In addition to the standard type, two different type front fork springs are sold. A proper type should be selected according to the conditions of a racing course or the weight of the rider.

Type		Part No.	Spring rate (kg/mm)	I.D. mark*
Soft	Spring	1W6-23141-10	$k_1 = 0.228, k_2 = 0.310$	
	Spacer	1W6-23118-10	—	—
Standard	Spring	1W6-23141-00	$k_1 = 0.326, k_2 = 0.442$	
	Spacer	—	—	—
Hard	Spring	1W6-23141-20	$k_1 = 0.374, k_2 = 0.508$	
	Spacer	1W2-23118-10	—	—

* I.D. marking can be found scored on the top of the spring end.

REAR SHOCK (MONOCROSS SUSPENSION "DE CARBON" SYSTEM) AND SWING ARM**General features:**

This rear shock absorber, a recent Yamaha development, is of the nitrogen gas enclosed "De Carbon" type.

The main features are:

1. The damping performance can be adjusted.
2. The spring fitting load can be adjusted freely.
3. Application of the thermal compensator greatly helps improve fading resistance.

These noteworthy improvements have greatly contributed to the improved performance of the shock absorber.

—WARNING: —READ CAREFULLY—

This shock absorber contains highly compressed nitrogen gas.

Read and understand the following information before handling the shock absorber. The manufacturer cannot be held responsible for property damage or personal injury that may result from improper handling.

1. **Do not temper with or attempt to open the cylinder assembly. Injury may result.**

2. **Do not subject shock absorber to an open flame or other high heat. This may cause the unit to explode due to excessive gas pressure.**
3. **Do not deform or damage the cylinder in any way. Cylinder damage will result in poor damping performance.**
4. **Handle it with great care, for a score or scratch in the piston rod sliding portion will cause oil leakage.**
5. **Never remove the plug on the cylinder bottom. Injury may result.**

Notes on disposal (Yamaha dealers only)

Gas pressure must be released before disposal of shock absorber. To do so, drill a 2-3 mm hole through the cylinder wall at a point 10-15 mm above the bottom of the cylinder.

At this time, wear eye protection to prevent eye damage from escaping gas and/or metal chips.

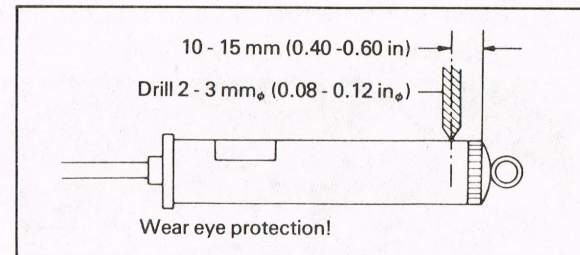
**—WARNING: —**

To dispose of a damaged or worn out shock absorber, take the unit to your Yamaha dealer for this disposal procedure.

Rear shock absorber (Monocross suspension) removal

1. Remove the two bolts holding the fuel tank (petcock lever must be turned OFF). Lift up the front of the tank and remove it. And remove the rear wheel.

2. Remove the cotter pin and nut. Remove the bolt securing the upper bracket to frame.
3. Remove the cotter pin and pull out the pivot shaft from the lower bracket.

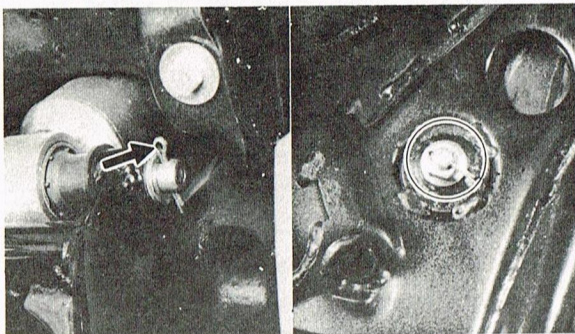

NOTE: _____

Put a proper support under the engine to keep the machine from falling over.

4. Remove the rear shock absorber from the frame. (To remove, pull the rear shock backward while lifting up the frame.)

NOTE: _____

- a. When removing the shock absorber, be careful not to bend the absorber rod.
- b. Take care so the two washers are not lost.

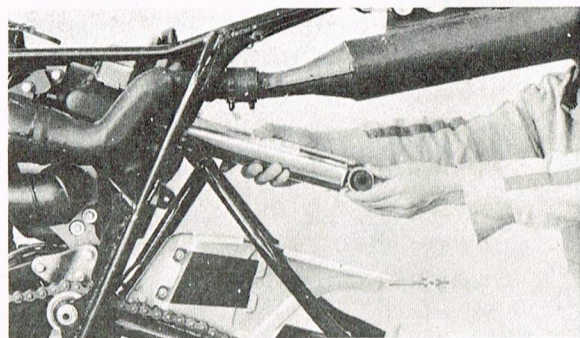

Adjustment

When bottoming feels excessive and too soft:

- a. Increase the spring pre-load
- b. Make damping performance stiffer

When springing feels excessive and too hard:

- a. Decrease the spring pre-load
 - b. Make damping performance softer
1. Changing suspension spring pre-load: Perform this adjustment with a special wrench (in the owner's tool kit).
 - a. Loosen the adjuster lock nut.
 - b. To increase pre-load, screw IN the adjuster. To decrease pre-load, screw OUT the adjuster.
 - c. Tighten the lock nut.

Tightening torque:
6.0 m-kg (43 ft-lb)

NOTE: _____

Initial fitting length is set for 261.5 mm. Adjustable extent is (maximum) 271.5 mm and (minimum) 256.5 mm. Be sure to adjust within the above limits.

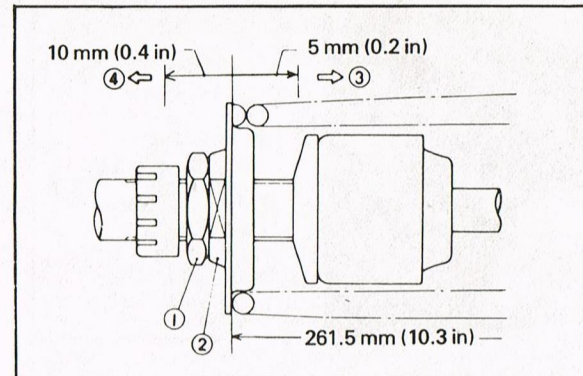

- | | |
|------------------|-------------|
| 1. Lock nut | 3. Increase |
| 2. Adjusting nut | 4. Decrease |

2. Changing damping performance
Adjustment can be made without removing the shock absorber. Turn the adjuster with a slotted-head screwdriver through the hole provided one each on either side of the frame.

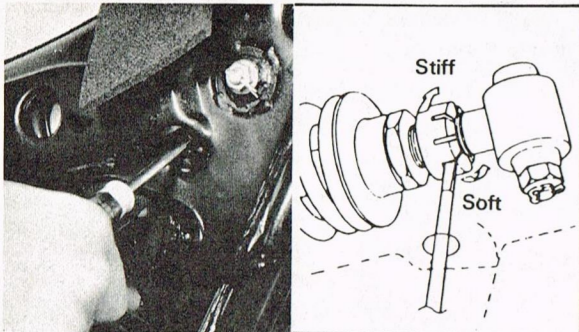

- a. To make it stiffer, screw IN the adjuster.
- b. To make it softer, screw OUT the adjuster. Make notch by notch adjustment and test it by riding after each adjustment.

NOTE: _____

Turn the adjuster until it clicks. Maximum (Minimum) extent can be known by the position where turning suddenly feels heavy (light). Do not give any more turns.

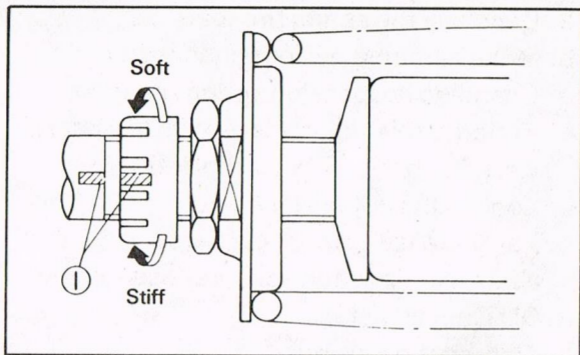

1. Alignment mark (Yellow paint)

3. Gas pressure
The gas pressure can be adjusted. For this adjustment, take the unit to your Authorized Yamaha dealer.

Rear shock spring "B" replacement

In addition to the standard type, two different type rear shock springs are sold. A proper type should be selected according to the conditions of a racing course or the weight of the rider.

Type	Part No.	Spring constant (kg/mm)	Color code
Soft	90501-80483	$k_1 = 3.03$ $k_2 = 6.18$	Yellow
Standard	90501-85470	$k_1 = 3.37$ $k_2 = 6.18$	Blue
Stiff	90501-90482	$k_1 = 3.68$ $k_2 = 6.18$	Red

NOTE: _____

1. Code color is shown on the end of the spring.
2. The spring rate specified above is based on the combination of spring A and B.

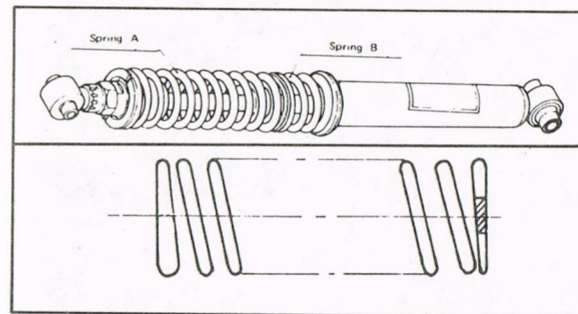

Swing arm inspection

1. With rear wheel and shock absorbers removed, grasp the ends of the arm and move from right to left to check for freeplay.

Swing arm freeplay:
0 – 1 mm (0 – 0.04 in)

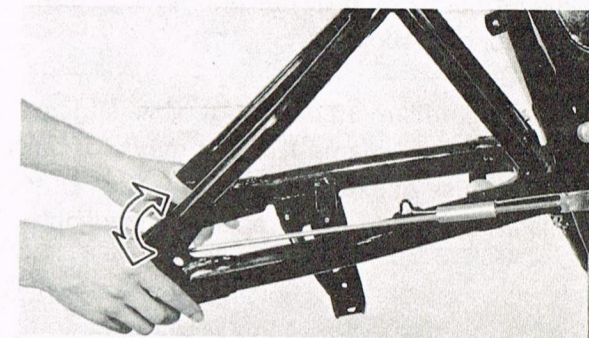

2. If freeplay is excessive, remove swing arm and replace swing arm bushing.

ELECTRICAL

General information

The IT250E/400E use a flywheel magneto to generate electrical current/voltage for the lighting system and uses CDI system for ignition. There are two coils attached to the magneto backing plate. The righthand coil supplies primary voltage to the ignition coil. The lefthand coil provides alternating current (AC) for operation of the lights.

NOTE:

If headlight filament burns out while engine is running, the tail lamp filament may also burn out because of excess voltage. Always check taillight operation when replacing headlight.

CIRCUIT DIAGRAM

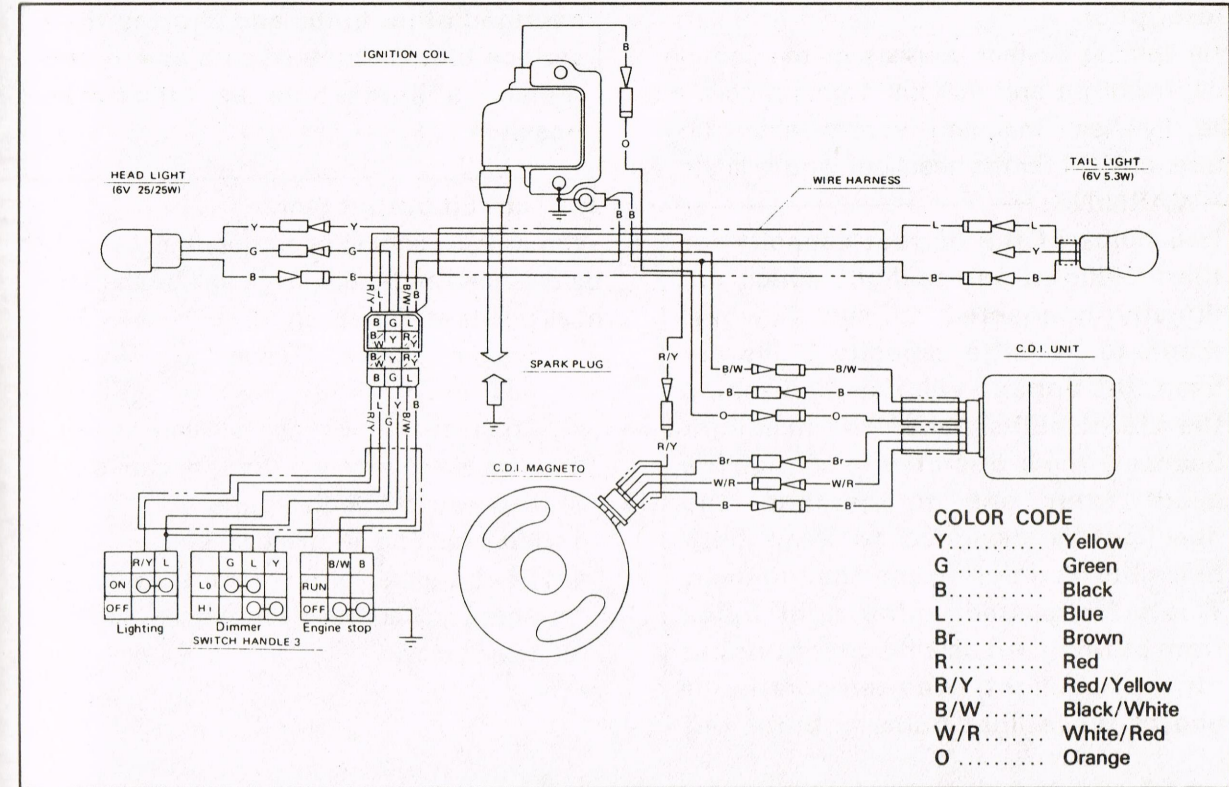

LIGHTING SYSTEMS

Description

The lighting system consists of the lighting coil, headlight and taillight. Lighting coils in the flywheel magneto supply alternating current (A.C.) for the headlight, and taillight.

WARNING:

Use bulbs of the correct capacity for the headlight, and taillight which are directly connected to the flywheel magneto. If large capacity bulbs are used, the voltage will rise, shortening the life of bulbs. When the headlight beam switch is operated to change the beam from one to another, the headlight is designed to keep both bulbs burning during the change over. This is to protect other light bulbs from burning out as a result of turning off the headlight, even temporarily. If one of these light bulbs is burnt out

while the machine is running, it will overload other bulbs and shorten their service life. Reduce engine speed and replace a burnt bulb as quickly as possible.

A.C. circuit output test

With all A.C. light in operation the circuit will be balanced and the voltage will be the same at all points at a given r.p.m.

1. Switch Pocket Tester to "AC20V" position.
2. Connect positive (+) test lead to Red/- Yellow connection and negative (-) test lead to a good ground.
3. Connect Engine speeds meter.
4. Start engine, turn on lights switch and check voltage at each engine speed in table below.

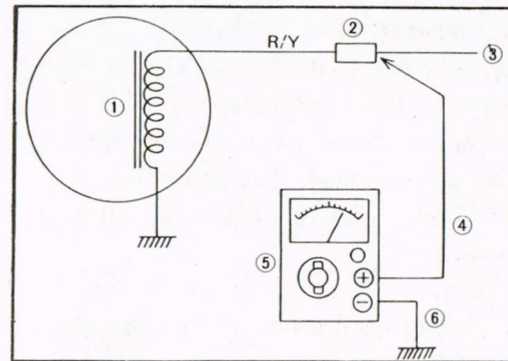

1. Lighting coil
2. Connector
3. To head light and tail light
4. Positive lead wire of tester
5. Pocket tester (Set the tester in A.C. 20V position)
6. Negative lead wire R/Y: Red/Yellow

If measured voltage is too high or too low, check for bad connections, damaged wires, burned out bulbs or bulb capacities are too large throughout the A.C. lighting circuit.

Output voltage:

IT250E: 5.0V or more / 2,500 r/min
IT400E: 7.0V or less / 8,000 r/min

NOTE: _____
Be sure to turn the lighting switch to ON.

NOTE: _____
This voltage test can be made at any point throughout the A.C. lighting circuit and the readings should be the same as specified above.

Lighting coil resistance check

If voltage is incorrect in A.C. lighting circuit, check the resistance of the yellow-red wire windings of the lighting coil.

1. Switch pocket tester to " $\Omega \times 1$ " position and zero meter.
2. Connect positive (+) test lead to Red/- Yellow wire from magneto and negative (-) test lead to a good ground on engine. Read the resistance on ohms scale.

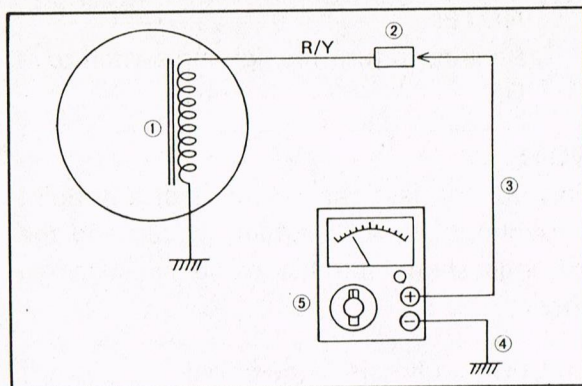

R/Y: Red/Yellow

1. Lighting coil
2. Connector
3. Positive lead wire of tester
4. Negative lead wire
5. Pocket tester (Set the tester "Resistance" position)

Lighting coil resistance:

IT250E: $0.39\Omega \pm 10\%$ at 20°C

IT400E: $0.53\Omega \pm 10\%$ at 20°C

Troubleshooting

1. Check for spark at spark plug — if no spark, check connectors.
2. If connections are clean and tight, refer to Mechanical Adjustments, Ignition Timing. Ensure that the timing is correct.

Any further troubleshooting of the C.D.I. system must be performed by your Yamaha Dealer.

INTERCHANGEABILITY OF CDI MAGNETO AND TRANSMISSION

CDI magneto and transmission from IT250E/400E can be interchangeably used on YZ400E/DT400E.

The following explains this interchangeability for your reference where necessary.

C.D.I. magneto

C.D.I. magneto and C.D.I. unit are installed on each model in a combination as listed

below, each combination being interchangeable for use on IT250E, IT400E and YZ400E.

	IT400E	IT250E	YZ400E
CDI. Magneto P/N Type moment of inertia	Outer rotor 1W6-85500-20 F3T35072 50 kg·cm ²	← 1W5-85500-20 F3T35171 38 kg·cm ²	← 1W4-85500-20 F3T35172 ←
CDI. Unit P/N Type	1M2-85540-21 F8T00372	1W4-85540-20 F8T00375	← ←
Lighting coil	with	←	without

It is not possible to change from inner to outer rotor type or vice versa.

Transmission

The following table shows the reduction ratios of transmission gears of each model. Between the models of IT400E, YZ400E, DT250E and DT400E, any set of wheel and pinion gears is interchangeable, and also the transmission assembly is interchangeable. The IT250E transmission is a 6-speed type and interchangeable as an assembly, with each of the above four models.

On the YZ250E, there is no interchangeability with any other models, whether the transmission assembly or a set of wheel and pinion gears.

Speed		Model				
		IT250E	IT400E	YZ400E	DT250E	DT400E
1st	1st wheel gear	38/14	33/13	32/14	33/13	38/14
	Main axle					
2nd	2nd wheel gear	31/15	29/17	29/17	34/19	34/19
	2nd pinion gear					
3rd	3rd wheel gear	32/20	26/20	26/20	26/20	26/20
	3rd pinion gear					
4th	4th wheel gear	29/23	23/23	23/23	23/23	23/23
	4th pinion gear					
5th	5th wheel gear	21/20	20/26	21/25	20/26	20/26
	5th pinion gear					
6th	6th wheel gear	22/24	—	—	—	—
	6th pinion gear					

Circuit Diagram

YZ400E

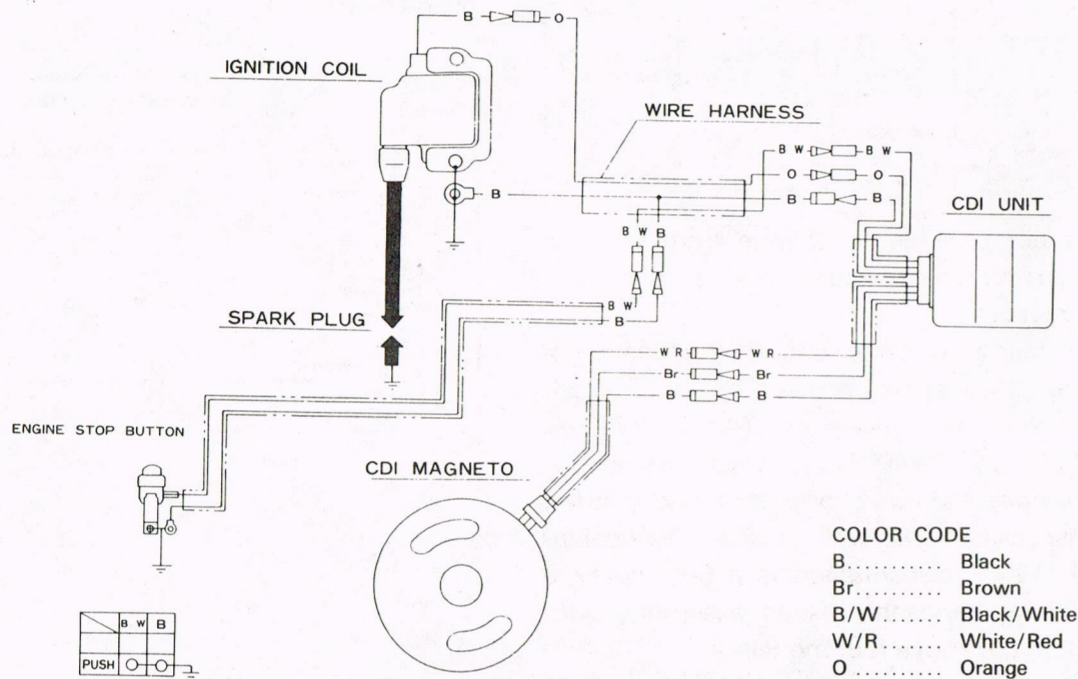

INSTALLATION OF THE OFF-ROAD RIDING KIT

An off-road riding kit is provided with each vehicle to comply with noise level and spark arrester laws and regulations. Performance will be substantially decreased. Returning is not required.

Description of the kit

Part name	Q'ty	
	IT250E	IT400E
Cylinder head gasket (b) (t = 2.0)	-	1
Cylinder head gasket (a) (t = 1.0)	1	1
Choke plate	1	1
Main jet	-	1
Choke pipe	1	1
Silencer cap	1	1
Absorber	12	14

Installing the kit parts

1. Cylinder head gasket

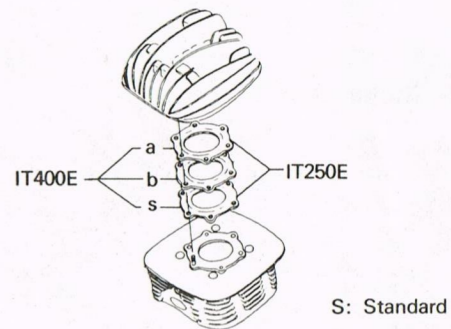

2. Choke plate

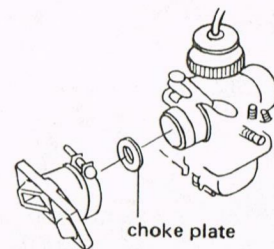

3. Main jet

for main jet installation, refer to page 36.

4. Choke pipe

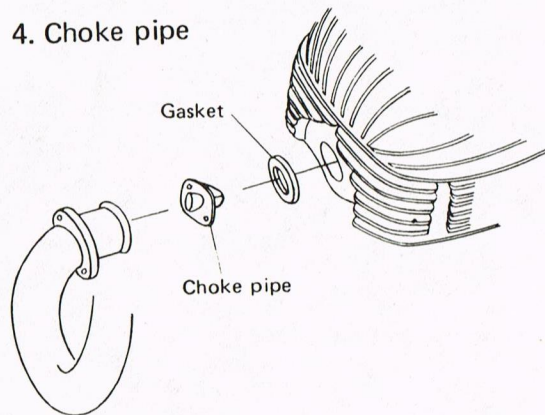

5. Silencer cap

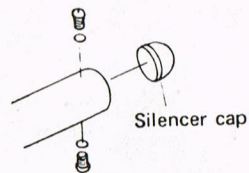

6. Absorber

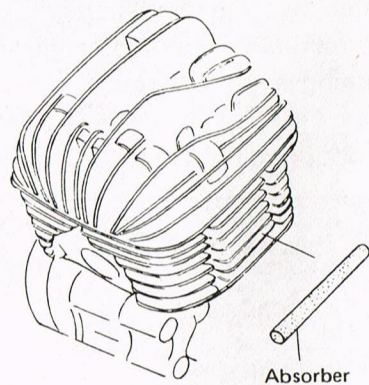

Troubleshooting

Although Yamaha motorcycles are given a rigid inspection before shipment from the factory, trouble may occur in operation. If this happens check the motorcycle in accordance with the procedures given in the troubleshooting chart below. If repair is necessary, ask your Yamaha dealer.

The skilled technicians at your Yamaha dealer provide excellent service. For replacement parts, use only genuine Yamaha parts. Imitation parts are similar in shape but often inferior in quality of materials and workmanship; consequently, service life is shorter and more expensive repairs may be necessitated.

Any fault in the fuel, compression or ignition system can cause poor starting or loss of power while riding. The troubleshooting chart describes quick and easy procedures for checking these systems.

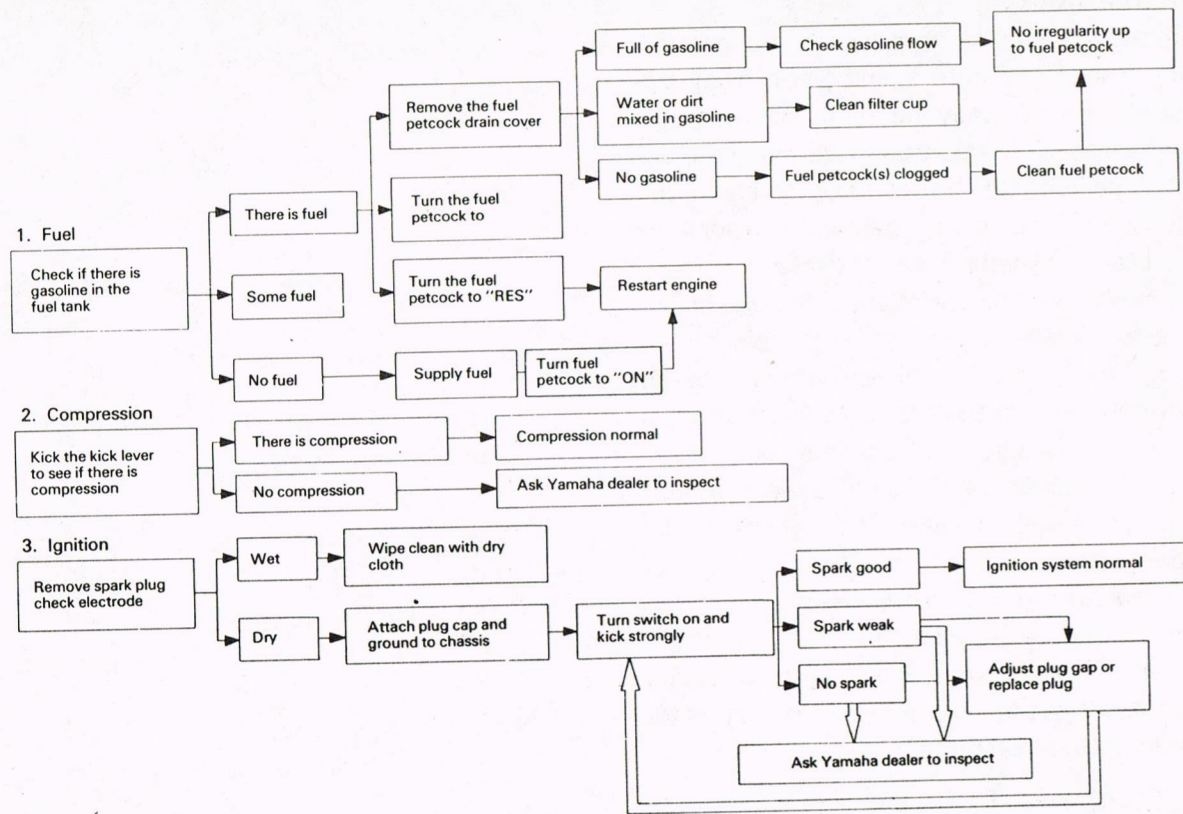

CLEANING AND STORAGE

Cleaning

Frequent thorough cleaning of your motorcycle will not only enhance its appearance, but will improve general performance and extend the useful life of many components.

1. Before Cleaning the Machine:

Block off end of exhaust pipe to prevent water entry; a plastic bag and strong rubber band may be used.

2. If engine case is excessively greasy, apply degreaser with a paint brush. Do not apply degreaser to chain, sprockets, or wheel axles.

3. Rinse dirt and degreaser off with garden hose, using only enough hose pressure to do the job. Excessive hose pressure may cause water seepage and contamination of wheel bearings, front

forks, brake drums, and transmission seals. Many expensive repair bills have resulted from improper high-pressure detergent applications such as those available in coin-operated car washes.

- Once the majority of dirt has been hosed off, wash all surfaces with warm water and mild detergent-type soap. An old toothbrush or bottle brush is handy to reach those hard-to-get-to places.
- Rinse machine off immediately with clean water and dry all surfaces with a chamois skin, clean towel, or soft absorbent cloth.
- Immediately after washing, remove excess moisture from chain and lubricate to prevent rust.
- Clean the seat with a vinyl upholstery cleaner to keep the cover pliable and glossy.

8. Automotive-type wax may be applied to all painted and chrome-plated surfaces. Avoid combination cleaner-waxes. Many contain abrasives which may mar paint or protective finish.
9. After finishing, start the engine immediately and allow to idle for several minutes.

Storage

Long term storage (30 days or more) of your motorcycle will require some preventive procedures to insure against deterioration. After cleaning machine thoroughly, prepare for storage as follows:

1. Drain fuel tank, fuel lines, and carburetor float bowl.
2. Remove empty fuel tank, pour a cup of 10W to 30W oil in tank, shake tank to coat inner surfaces thoroughly and drain off excess oil. Re-install tank.
3. Remove spark plug, pour about one

table-spoon of 10W to 30W oil in spark plug hole and reinstall spark plug. Kick engine over several times (with ignition off) to coat cylinder wall with oil.

4. Remove drive chain. Clean thoroughly with solvent and lubricate with graphite-base chain lubricant. Re-install chain or store in a plastic bag (tie to frame for safe-keeping).
5. Lubricate all control cables.
6. Block up frame to raise both wheels off ground.
7. Deflate tires to 12 lb/in² (0.8 kg/cm²).
8. Tie a plastic bag over exhaust pipe outlet to prevent moisture entering.
9. If storing in humid or salt-air atmosphere, coat all exposed metal surfaces with a light film of oil. Do not apply oil to rubber parts or seat cover.

MISCELLANEOUS

CONVERSION TABLES

Metric to Inch System		
KNOWN	MULTIPLIER (Rounded off)	RESULT
TORQUE		
m-kg	7.233	ft-lb
m-kg	86.80	ft-lb
cm-kg	0.0723	in-lb
cm-kg	0.8680	in-lb
WEIGHT		
kg	2.205	lb
g	0.0353	oz
FLOW/DISTANCE		
km/lit	2.352	mpg
km/h	0.6214	mph
km	0.6214	mi
m	3.2809	ft
m	1.0936	yd
cm	0.3937	in
mm	0.03937	in
VOLUME/CAPACITY		
cc	0.03381	oz(U.S.liq)
cc	0.06103	cu.in
lit	2.1134	pt(U.S.liq)
lit	1.057	qt(U.S.liq)
lit	0.2642	gal(U.S.liq)
MISC		
kg/mm	55.9970	lb/in
kg/cm ²	14.2233	psi(lb/in ²)
Centigrade (°C)	9/5(°C)+32	Fahrenheit(°F)

DEFINITION OF TERMS:

m-kg — Meter-kilogram: Usually torque.
 g — Gram.
 kg — Kilogram: 1,000 grams.
 km — Kilometer.
 lit — Liter.

Inch to Metric System		
KNOWN	MULTIPLIER (Rounded off)	RESULT
TORQUE		
ft-lb	0.1383	m-kg
ft-lb	13.8313	m-kg
in-lb	0.01152	cm-kg
in-lb	1.1522	cm-kg
WEIGHT		
lb	0.4536	kg
oz	28.3286	g
FLOW/DISTANCE		
mi/gal	0.4252	km/lit
mi/h	1.6093	km/h
mi	1.6093	km
ft	0.3048	m
yd	0.9144	m
in	2.540	cm
in	25.40	mm
VOLUME/CAPACITY		
oz(U.S.liq)	29.577	cc
cu.in	16.385	cc
pt(U.S.liq)	0.4732	lit
qt(U.S.liq)	0.9461	lit
gal(U.S.liq)	3.7850	lit
MISC		
lb/in	0.01786	kg/mm
psi(lb/in ²)	0.07031	kg/cm ²
Fahrenheit(°F)	5/9(°F-32)	Centigrade(°C)

km/lit — Kilometer per liter: Mileage.
 km/lit — Cubic centimeter (cm³): Volume or capacity.
 kg/mm — Kilogram per millimeter: Usually spring compression rate.
 kg/mm² — Kilogram per square centimeter: Pressure.

SPECIFICATIONS

These specifications are for general use.

MODEL	IT250E	IT400E
DIMENSIONS/WEIGHT		
Overall length	2,220 mm (87.4 in)	←
Overall width	910 mm (35.8 in)	←
Overall height	1,145 mm (45.1 in)	←
Wheelbase	1,430 mm (56.3 in)	←
Minimum ground clearance	240 mm (9.4 in)	←
Seat height (unloaded)	870 mm (34.3 in)	←
Machine net weight	122 kg (269 lb)	124 kg (273 lb)
ENGINE		
Type	Air cooled, 2-stroke, single	←
Bore/Stroke	70 × 64 mm (2.76 × 2.52 in)	85 × 70 mm (3.35 × 2.76 in)
Displacement	246 cc (8.36 oz)	397 cc (13.5 oz)
Compression ratio	7.8 : 1	7.6 : 1
Starting system	Kick starter	←
Lubricating system	Mixed gas 20 : 1	←
CARBURETION		
Manufacturer/Type	MIKUNI VM36SC	MIKUNI VM38SC
Effective venture size	36 mm	38 mm
Main jet	#360	#350
Needle jet	P-6	P-4

MODEL	IT250E	IT400E
Jet needle	6F 15-2	6F 16-3
Pilot jet	#60	#50
Air screw (Turns out)	1.0	2-1/4
Cut away	2.0	3.0
Float level	18.1 mm (0.71 in)	←
CLUTCH		
Type	Wet multiple disc type	←
Primary reduction system	Helical gear	←
Primary reduction ratio	64/24 (2.666)	←
TRANSMISSION		
Type	Constant mesh, 6 speed forward	Constant mesh, 5 speed forward
Reduction ratio 1st	38/14 2.714	33/13 2.538
2nd	31/15 2.067	29/17 1.706
3rd	32/20 1.600	26/20 1.300
4th	29/23 1.261	23/23 1.000
5th	21/20 1.050	20/26 0.769
6th	22/24 0.917	
SECONDARY DRIVE		
Reduction system	Chain	←
Chain type/size	DK520TR / 103L	DK520TR / 105L
Reduction ratio	46/14 3.286	46/15 3.066

MODEL	IT250E	IT400E
ELECTRICAL		
Magneto type / Manufacturer / Model	C.D.I. Magneto / MITSUBISHI / F3T35171	C.D.I. Magneto / MITSUBISHI / F3T35072
Coil/Manufacturer	F6T41174 / MITSUBISHI	←
C.D.I. unit/Manufacturer	F8T00375 / MITSUBISHI	F8T00372 / MITSUBISHI
Headlight	25W / 25W	←
Taillight	5.3W	←
CHASSIS		
Frame type	Tubular steel double cradle	←
Front suspension travel	215 mm (8.46 in)	←
Rear wheel travel	185 mm (7.28 in)	←
Caster / Trail	58°30' / 142 mm (5.59 in)	←
Front tire size	3.00-21-4PR	←
Nominal pressure	0.9 kg/cm ² (12.8 psi)	←
Rear tire size	4.5-18-4PR	←
Nominal pressure	1.1 kg/cm ² (15.6 psi)	←
Tread type (Front and Rear)	Full knobby	←
Brake type	Drum (leading/trailing)	←
Actuating method, Front/Rear	Cable / Link rod	←
	Drum (leading/trailing)	←
	Link rod	←

MODEL	IT250E	IT400E
VOLUME/TYPE FLUID		
Fuel tank / Type (Gasoline: Oil ratio)	12 lit / premium (20 : 1)	←
Transmission / Type	1,050 ~ 1,150 cc (oil change)	←
	1,150 ~ 1,250 cc (total)	←
	/Yamalube 4-cycle	
Front fork (each) Type	250 cc / SAE 20W	←
Rear shock nitrogen gas pressure	18 kg/cm ² (255.6 psi)	←

NOTE:

The Research and Engineering Departments of Yamaha are continually striving to further improve all models. Improvements and modifications are therefore inevitable. In light of this fact, the foregoing specifications are subject to change without notice to the owner. Information regarding significant changes is forwarded to all Authorized Yamaha Dealers as soon as available. If a discrepancy is noted, please consult your dealer.

MAINTENANCE SPECIFICATIONS

MODEL	IT250E	IT400E
C.D.I. IGNITION		
Ignition coil resistance (Primary)	1.0Ω±10% / 20°C	←
(Secondary)	5.9KΩ±20% / 20°C	←
Ignition timing (Advanced)	2.3 mm (0.09 in)	2.7 mm (0.106 in)
Spark plug (Normal conditions)	N2G Champion	N3G Champion
Spark plug gap	0.7 mm	←

MODEL	IT250E	IT400E
ENGINE - TOP END		
Piston clearance	0.045 - 0.050 mm	←
Piston wear limit	0.1 mm	←
Ring end gap (Installed)	0.3 - 0.5 mm	←
Connecting rod / Axial play	0.4 - 2.0 mm	←
Connecting rod / Crank side clearance	0.25 - 0.75 mm	←
ENGINE - CLUTCH		
Friction plate thickness	3.0 mm (0.12 in) × 6 (2.7 mm minimum)	3.0 mm (0.12 in) × 7 ←
Clutch plate warp allowance	0.05 mm	←
Clutch spring free length	36 mm (1.42 in) (35 mm minimum)	←
CHASSIS		
Front brake shoe diameter	130 mm (5.12 in)	←
Front brake shoe replacement limit	126 mm (4.96 in)	←
Rear brake shoe diameter	160 mm (6.3 in)	←
Rear brake shoe replacement limit	156 mm (6.14 in)	←
Wheel run-out limits vertical	1.0 mm (0.04 in)	←
Wheel run-out limits lateral	0.5 mm (0.02 in)	←
TORQUE VALUES		
Cylinder head	M8 2.5 m-kg (18 ft-lb)	←
Cylinder	M10 3.5 m-kg (25.2 ft-lb)	←
Clutch boss	M20 7.5 m-kg (54 ft-lb)	←

MODEL	IT250E	IT400E
Primary drive gear	M18 7.5 m-kg (54 ft-lb)	←
Drive sprocket	M18 7.5 m-kg (54 ft-lb)	←
C.D.I. rotor	M12 8.0 m-kg (58 ft-lb)	←
Engine mounting bolt (front, upper)	M8 2.5 m-kg (18 ft-lb)	←
Engine mounting bolt (front, lower)	M8 2.5 m-kg (18 ft-lb)	←
Engine mounting bolt (rear, upper)	M8 2.5 m-kg (18 ft-lb)	←
Engine mounting bolt (rear, lower)	M8 2.5 m-kg (18 ft-lb)	←
Handle crown and inner tube	M8 1.5 m-kg (11 ft-lb)	←
Handle crown and steering shaft pinch bolt	M8 1.5 m-kg (11 ft-lb)	←
Steering stem bolt	M14 6.0 m-kg (43 ft-lb)	←
Handle crown and handle holder	M8 1.5 m-kg (11 ft-lb)	←
Under bracket and inner tube	M8 2.5 m-kg (11 ft-lb)	←
Under bracket and steering shaft	M10 2.0 m-kg (15 ft-lb)	←
Front fork cap bolt	M34 2.5 m-kg (18 ft-lb)	←
Front wheel axle	M15 6.0 m-kg (43 ft-lb)	←
Pivot shaft	M16 9.0 m-kg (65 ft-lb)	←
Rear wheel axle	M16 8.0 m-kg (58 ft-lb)	←
Driven sprocket	M8 2.5 m-kg (18 ft-lb)	←
Rear hub stud bolt	M8 2.5 m-kg (18 ft-lb)	←
Rear suspension ass'y (frame)	M8 2.5 m-kg (18 ft-lb)	←
(Adjuster lock nut)	M20 6.0 m-kg (43 ft-lb)	←

WARRANTY INFORMATION

STATEMENT OF PURCHASER'S RESPONSIBILITY

This (model) Yamaha motorcycle is sold AS IS, WITHOUT ANY WARRANTIES EXPRESSED OR IMPLIED REGARDLESS OF THE INTENDED USE.

THE PURCHASER OF THIS MOTORCYCLE, which is intended for competition purposes, IS RESPONSIBLE FOR ALL COSTS OF SERVICE AND/OR REPAIR.