



YAMAHA

**IT250D/IT400D
ASSEMBLY MANUAL**



SINCE 1887

YAMAHA MOTOR CO.,LTD.

IWATA, JAPAN

LIT-11666-00-57

PRINTED IN JAPAN

77-2-2.05 x 1

90894-07706

IMPORTANT NOTICE

This motorcycle may be equipped for general off road use. It may be illegal to operate this vehicle off-road when it is equipped for competition use.

Check your state and local riding area regulations. This vehicle is not manufactured for use on public streets, roads or high ways. Such use is prohibited by law. An off-road riding kit is provided with each vehicle to comply with noise level and spark arrester laws and regulations for installation instructions see directions in this manual.

Performance will be substantially decreased. Retuning is not required.

NOTICE

The service specifications given in this Assembly Manual are based on the model as manufactured. When this model may require improvements, the service specifications may be subject to change in the future. Modifications are inevitable and significant changes in specifications or procedures will be forwarded to Authorized Yamaha dealers. The assembly procedure is described in the order that the mechanic should follow, and the correct service tools should be used in the correct manner. Failure to do this may result in poor performance and harm to the rider.

Particularly important information is distinguished in this manual by the following notations:

NOTE: A NOTE provides key information to make procedures easier or clearer.

CAUTION:.... A CAUTION indicates special procedures that must be followed to avoid damage to the machine.

WARNING: .. A WARNING indicates special procedures that must be followed to avoid injury to a machine operator or person inspecting or repairing the machine.

YAMAHA IT250D/IT400D
ASSEMBLY MANUAL
1st EDITION, JANUARY 1977
OVERSEAS SERVICE DEPARTMENT
YAMAHA MOTOR CO., LTD.
IWATA, JAPAN
LIT-11666-00-57

CONTENTS

PREPARATION	1
UNPACKING	1
PARTS CHECK LIST	2
SET-UP PROCEDURES	3
INSTALLATION OF THE OFF-ROAD RIDING KIT	10
INSPECTION AND ADJUSTMENTS	11

PREPARATION

To assemble the machine correctly, the following supplies and working space are required.

Supplies

Oils, greases, shop rags, electrical contact cleaner, solvent for cleaning.

Workshop

The workshop where the machine is assembled should be clean and large. The floor should be level.

UNPACKING

Note on transportation

Use care not to butt the machine packed in the crate against a hard object or give it a heavy shock during transportation or in the service shop.

Procedure for unpacking

To remove the machine and parts packed in the cardboard crate, cut the vinyl bands around the box using scissors. Next, remove the exterior carton by lifting it straight up and remove the foam tray, front wheel, carrier bag and seat.

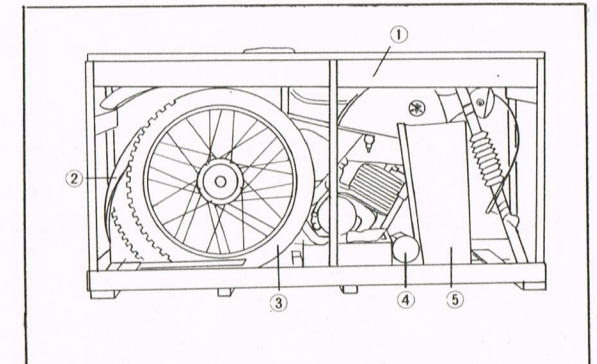

1. Foam tray 2. Front fender 3. Front wheel
4. Carrier bag 5. Seat

Remove the nails from each corner of the crate, and remove the struts. Remove the front fender held between the rear tire and the rear fender.

Lift up the machine, and remove the rear wheel section from the lower wooden case. Then take out the machine.

PARTS CHECK LIST

Before starting the assembly, check for damaged or missing parts (listed below). Also check the machine for damage, scratches and other defects.

Parts List: Carton box

No.	Part name	Q'ty
1	Front wheel	1
2	Semi double seat	1
3	Front fender	1
4	Carrier bag	1

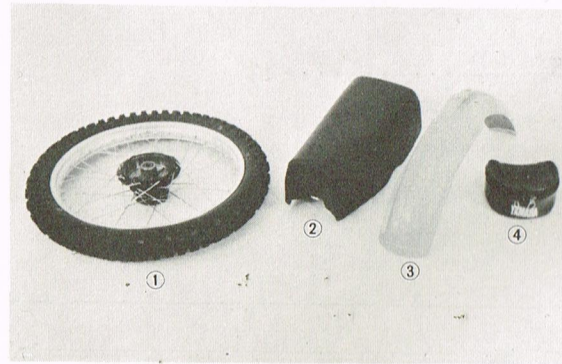

Parts List: Carrier bag (Off-road riding kit)

No.	Part name	Q'ty	
		IT250D	IT400D
1	Cylinder head gasket (t=2.0 mm)	—	1
2	Cylinder head gasket (t=1.0 mm)	1	1
3	Choke plate	1	1
4	Main jet	—	1
5	Choke pipe	1	1
6	Silencer cap	1	1
7	Absorber	12	14

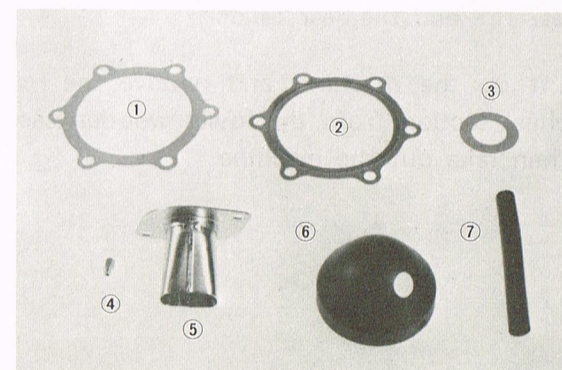

Parts List: Foam tray

No.	Part name	Q'ty
1	Vinyl bag 1	1
2	Vinyl bag 2	1
3	Vinyl bag 3	1
4	Tool assembly	1
5	Brake shoe plate with brake wire	1
6	Speedometer cable	1
7	Breather hose	1
8	Number plate	1
9	Owner's service manual	1
10	Speedometer assembly	1
11	Taillight assembly	1
12	Handlebar assembly	1

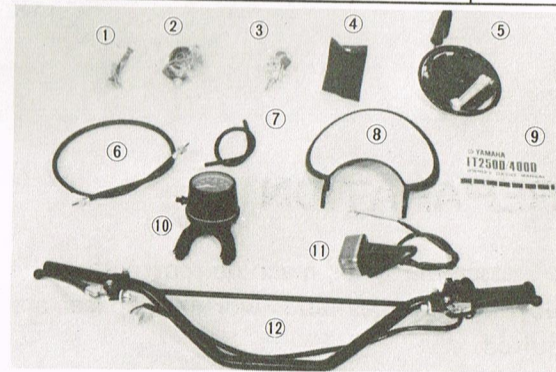

Parts List: Vinyl bag 1

No.	Part name	Q'ty	Remarks
1	Special washer	1	Taillight
2	Clamp	1	
3	Spring washer	2	
4	Nut	2	
5	Band	2	

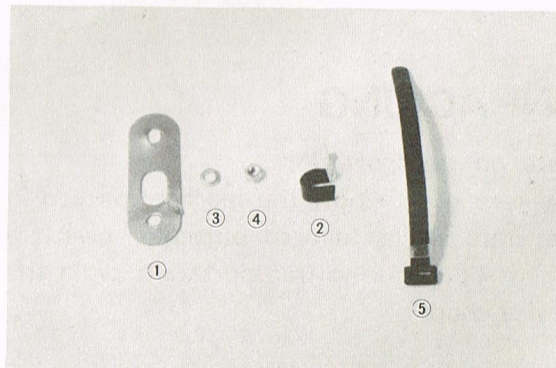

Parts List: Vinyl bag 2

No.	Part name	Q'ty	Remarks
1	Bolt with spring and plain washer	2	Speedometer
2	Gear unit assembly	1	Speedo. cable
3	Handle upper holder	2	Handlebar
4	Flange bolt	4	

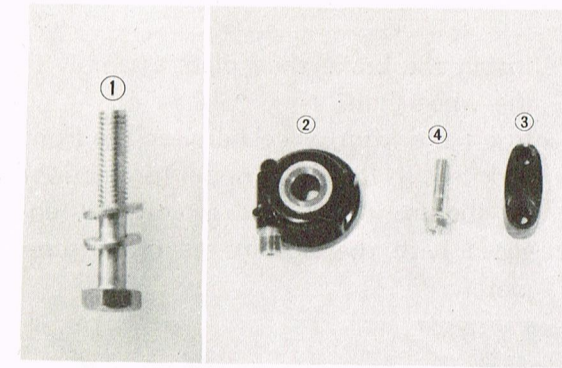

Parts List: Vinyl bag 3

No.	Part name	Q'ty	Remarks
1	Wire holder	1	Front brake
2	Nut	1	
3	Plain washer	1	
4	Panhead screw (5 mm)	1	Front fender
5	Collar	4	
6	Gromet	4	
7	Plain washer	4	
8	Bolt with spring washer (6x25 mm)	4	Carrier bag
9	Plain washer	3	
10	Bolt with spring washer (6x18 mm)	3	Seat
11	U-nut	2	
12	Plain washer	2	Front wheel
13	Bolt (6 mm)	2	
14	Cotter pin	1	Handlebar switch cord
15	Band	2	

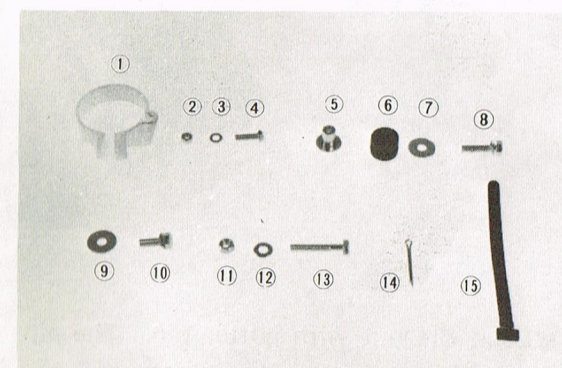

SET-UP PROCEDURES

- To set up the machine, place a proper-size wooden box under the engine to keep the front of the machine raised off the floor. Take care so that the machine does not fall over.
- Insert the front fender between the front fork legs, and secure the fender using the bolts, spring washers, plain washers, fender dampers and collars.

Tightening torque:
0.8 m·kg (5.8 ft·lb)

NOTE:
The front fender should be installed with the arrow mark on the fender facing forward.

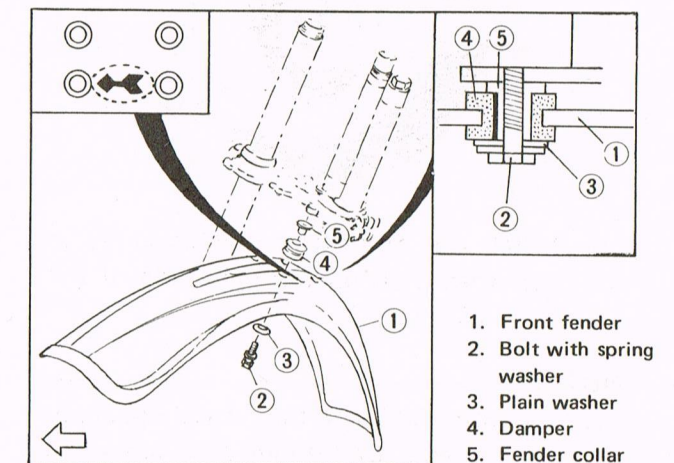

- Remove the front wheel axle nut and plain washer. Then remove the wheel axle.

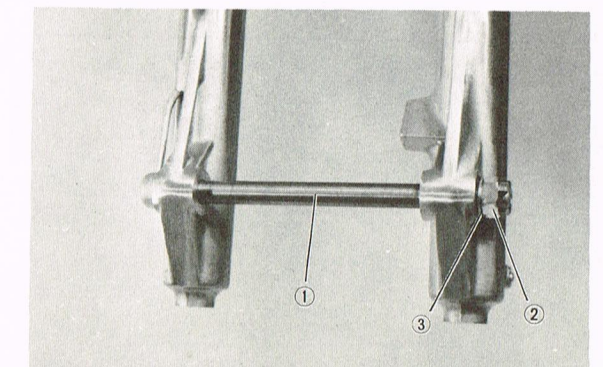

1. Wheel axle 2. Axle nut 3. Plain washer

4. Clean the brake shoe linings and wheel hub with a clean cloth.

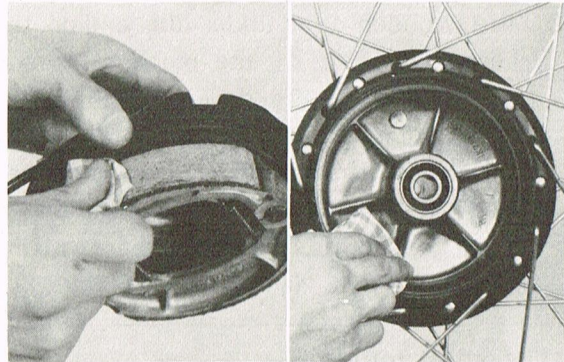

5. Make sure the brake shoes and springs are correctly installed in the shoe plate assembly. If any one of them is out of place, correct per the figure.

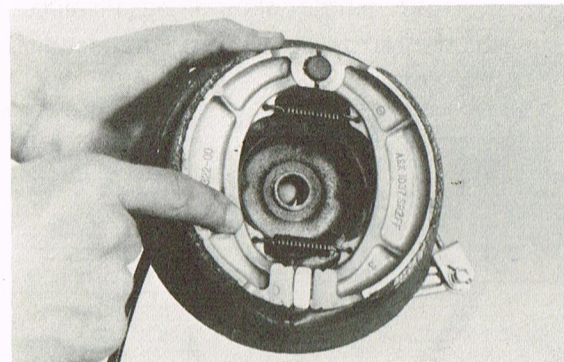

6. Install the meter gear unit assembly in the wheel hub on the right side of the front wheel.

NOTE:

- To avoid damaging the oil seal lip, apply a light coat of lithium base grease to the oil seal lip and meter gear unit assembly.
- Make sure that the three projections on the inside of the wheel hub are respectively placed between the projections on the meter clutch.

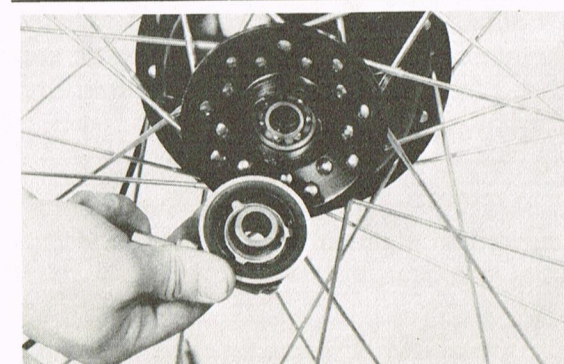

- Install the brake shoe plate assembly in the wheel hub.
- Insert the front wheel between the front fork legs so that the stopper (projection) on the front fork end is correctly engaged with the slot in the brake shoe plate.

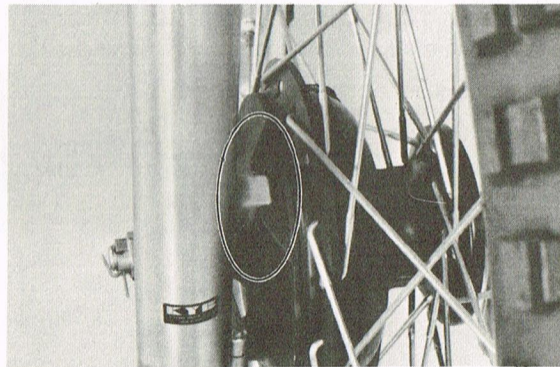
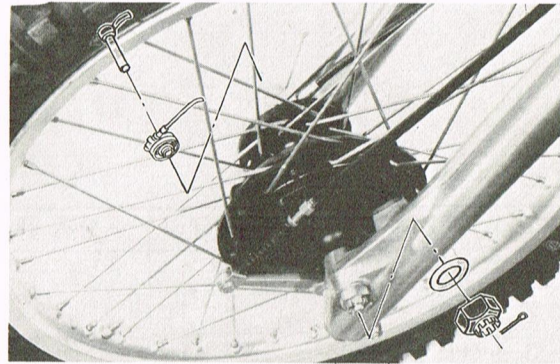

9. Insert the axle, and torque the axle nut to specification.

Tightening torque:
7.0 m-kG (50 ft-lb)

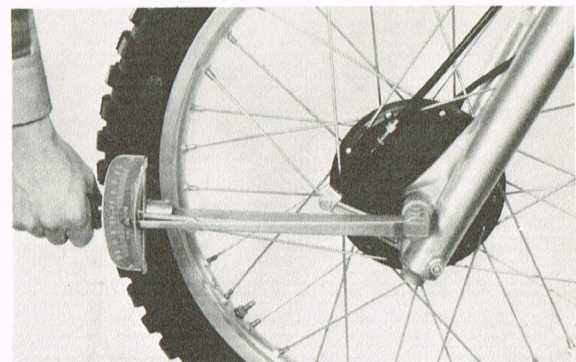

10. Lock the nut with cotter pin. The pin should be inserted downward, and the pin ends should be bent.

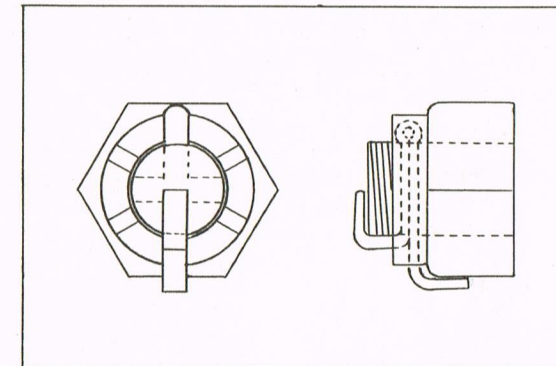

11. After passing the cable through the holder, install it to outer tube using the nut, plain washer and panhead screw. Connect the meter cable to gear unit.

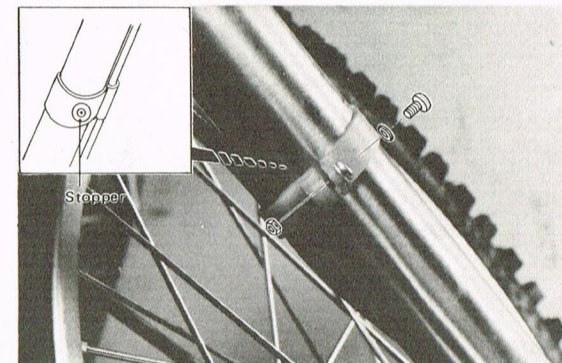

12. Pass the front brake wire through three wire holders as shown. And tighten screw.

For detailed cable routing, refer to "CABLE ROUTING DIAGRAM".

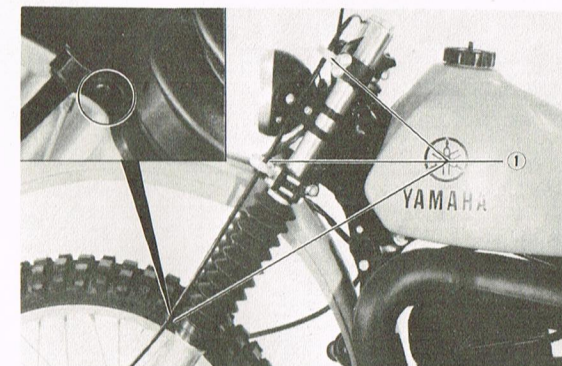

1. Wire holder

13. Install the handlebars using the two upper holders and four hexagon bolts.

CAUTION: First tighten the bolt on the front end of holder, and tighten the bolt on the rear end.

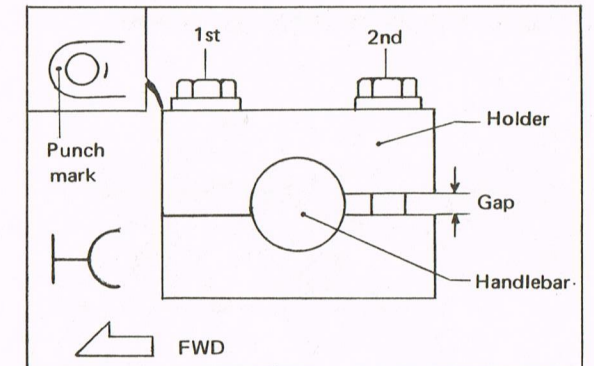

Tighten torque:
1.2 m-kG (8.6 ft-lb)

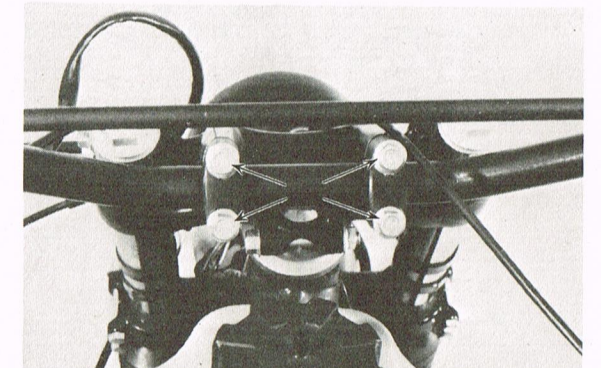

14. Wipe off any dust on right handlebar end, and apply a light coating of grease to handlebar end and throttle grip housing.

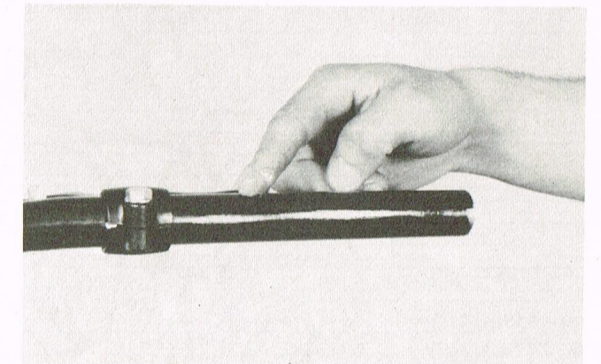

15. Bolt the upper and lower throttle housing together, and check the throttle grip for smooth action, then tighten the throttle housing screws.

CAUTION: Tighten the screws in the stages and maintain an equal gap on each side of holder.

IT 250D/IT400D WIRING DIAGRAM

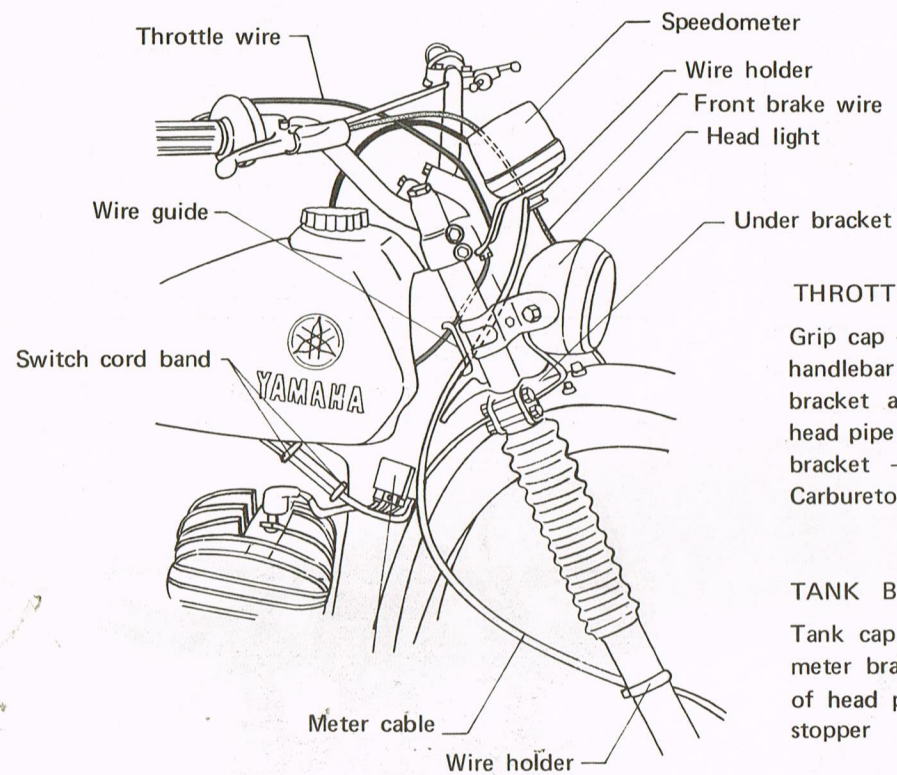

THROTTLE WIRE

Grip cap → Rear side of handlebar → Between handlebar and tension pipe → Between meter bracket and handle crown → Right side of head pipe → Wire guide → Over the tank fitting bracket → Clamp to frame main pipe → Carburetor

TANK BREATHER PIPE

Tank cap → Under the tensionbar → Between meter bracket and handle crown → Left side of head pipe → Through the hole in steering stopper

SPEEDOMETER CABLE

Speedometer → Right side of head pipe → Wire guide → Outside of wire harness → Fix with wire holder on inner side of outer tube → Connect the gear unit

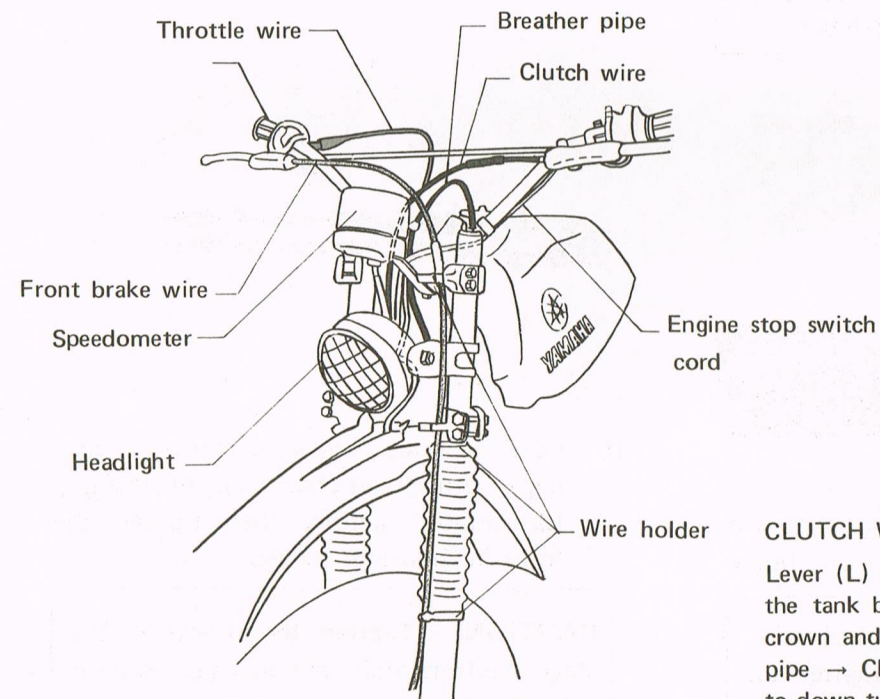

CLUTCH WIRE

Lever (L) → Front side of brake wire → Over the tank breather pipe → Between the handle crown and meter bracket → Left side of head pipe → Clamp to steering stopper → Clamp to down tube using switch cord band → Clutch wire holder of cylinder → Push lever

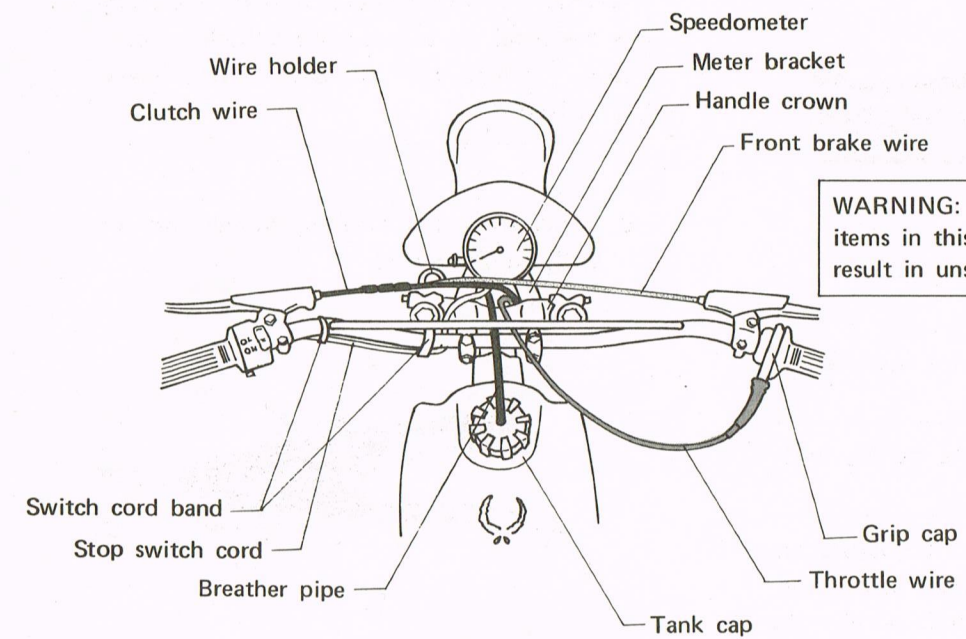

WARNING: Follow correct routing of all items in this diagram. Failure to do so could result in unsafe assembly of the machine.

FRONT BRAKE WIRE

Lever (R) → Front of clutch wire → Holder wire (Left side of handle crown) → Screw fasten the wire holder (Left side of under bracket) → Wire holder → (Left side of outer tube)

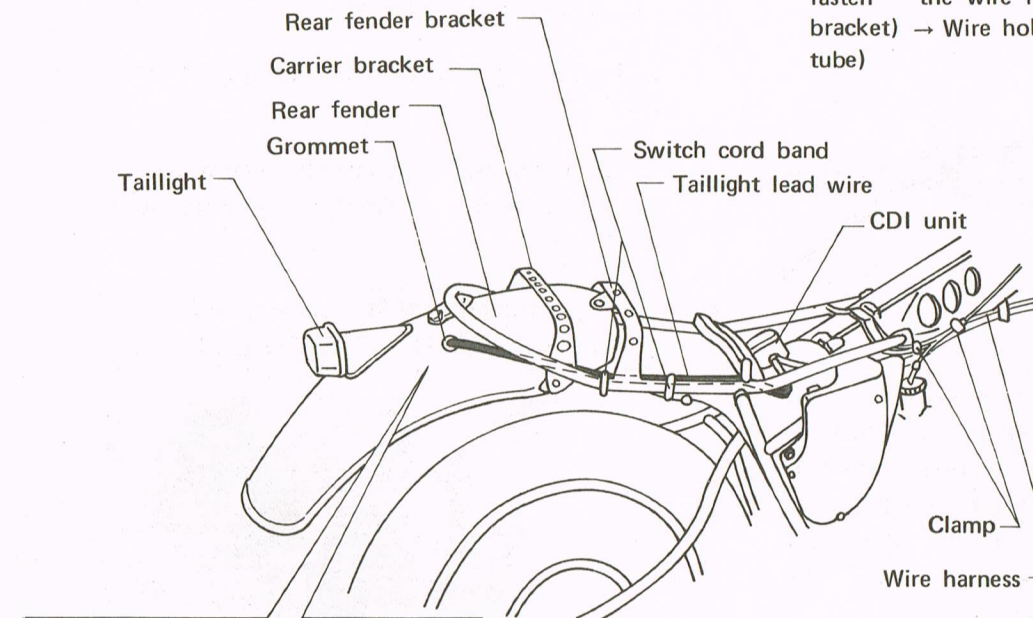

TAIL LIGHT LEAD WIRE

Taillight → Inside of rear fender → Clamp together with taillight → Outside of fender through the grommet → Between fender and seat rail → Between fender and carrier bracket → Clamp with switch cord band (Route the lead wire on seat rail) → Inside of fender bracket → Clamp with switch cord band → Connect to wire harness through grommet in mud guard

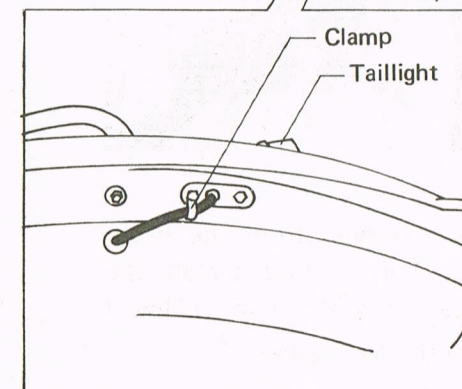

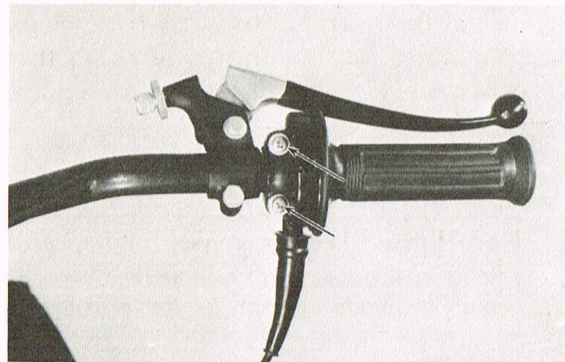

16. Brake wire and clutch wire installation

NOTE:
Before assembly, lubricate cables with suitable cable lubricant.

- Screw in the cable length adjusters on the brake shoe plate (brake wire) and cable length adjuster (clutch wire).
- Fully loosen the lever adjuster locknut and screw in the adjuster until tight. Next, align the slits in the adjuster and adjuster locknut with the slit in the lever holder.

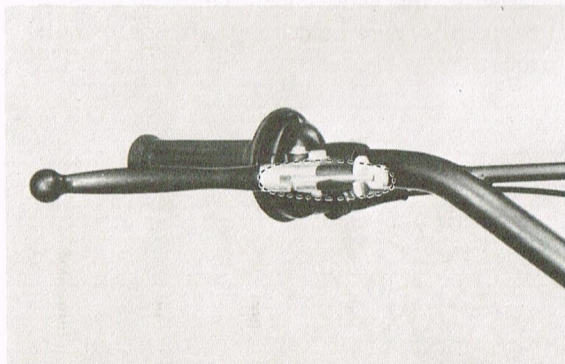

- Insert the wire end into the lever hole, and hook the outer cable end onto the adjuster locknut, then squeeze the lever. Next, while outer cable in the direction opposite the lever, release the lever quickly. While releasing it, seat the outer cable into the adjuster.

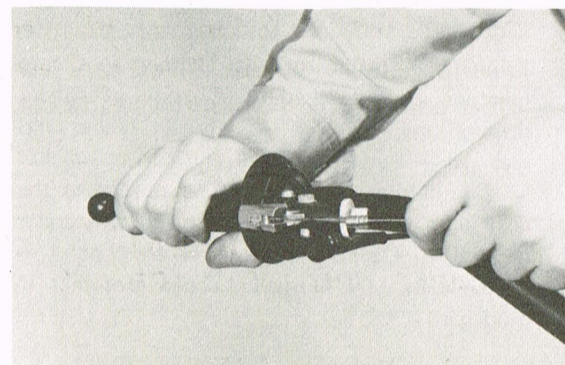

WARNING: Proper cable and wire routing is essential to insure safe vehicle operation, refer to "CABLE ROUTING DIAGRAM".

- Cover the brake and clutch lever holders with holder covers.

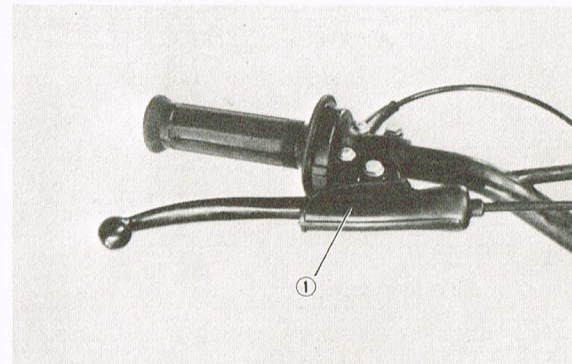

1. Holder cover

- Install the speedometer assembly under the handle crown using bolts with spring and plain washers.

Tightening torque: 0.7 m-kG (5 ft-lb)

- Connect the speedometer cable to the speedometer. Tighten securely with fingers.

For detailed cable routing, refer to "CABLE ROUTING DIAGRAM".

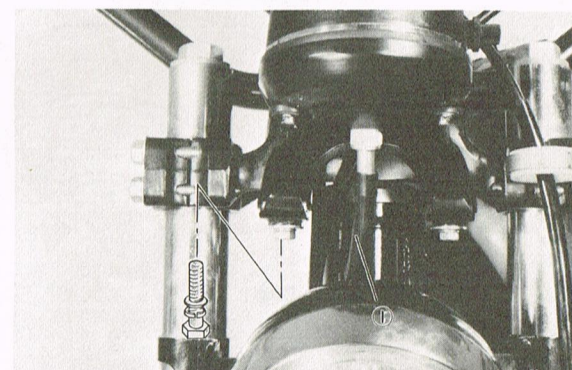

1. Meter cable

- Remove the two nuts from the headlight holding bolt. And install the number plate using the two removed nuts, spring and plain washers.

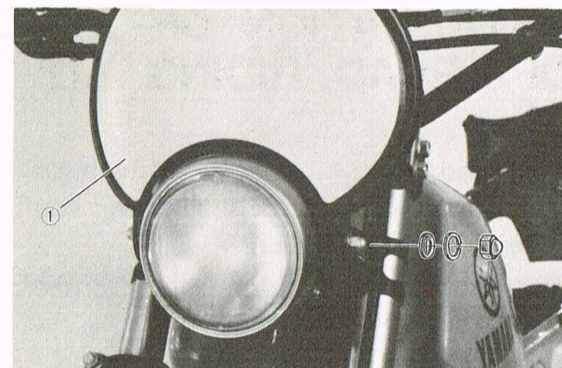

1. Number plate

- Remove the panhead screw from the headlight body. Then remove the headlight unit assembly.

- Clamp the switch lead wire with switch cord bands, and insert it into the hole of headlight body. Connect the lead wire to the coupler in the headlight body.

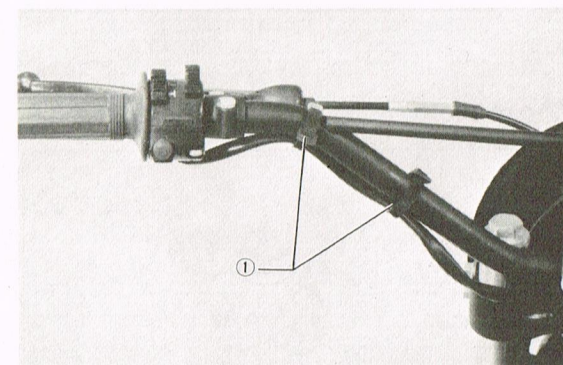

1. Switch cord band

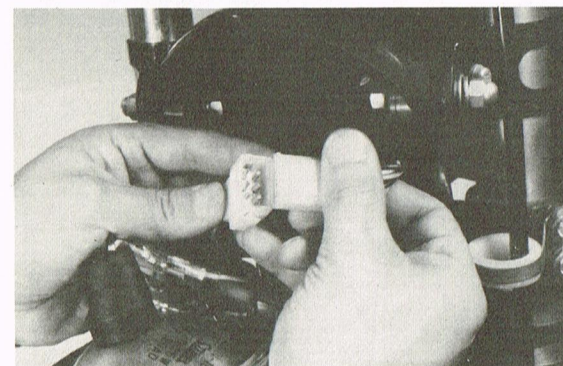

- When installing the headlight lens assembly, care should be used so that wires are not pinched.

- Install the carrier box and bracket 2 at the rear of the frame by using the bolt with washer and the plain washer.

Tightening torque:
0.7 m-kG (5 ft-lb)

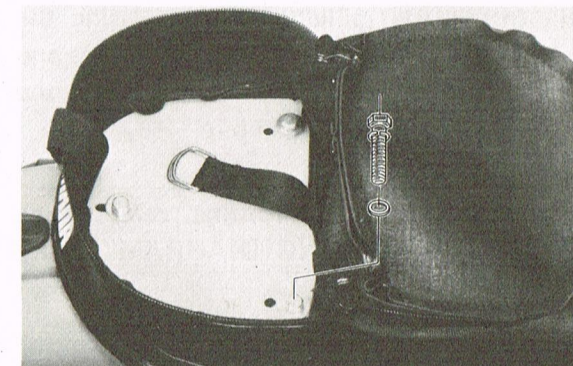

- Install the tool kit in the carrier box and secure the kit with a band.



- Connect one end of the air breather pipe on the fuel tank filler cap, and other end go down along the head pipe.

For detailed cable routing, refer to "CABLE ROUTING DIAGRAM"

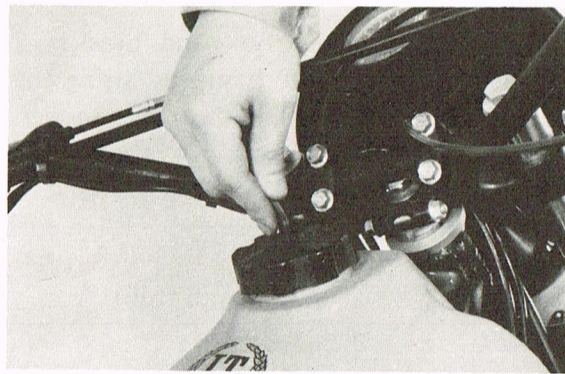

26. Install the taillight assembly using the special washer, clamp, spring washers and nuts. And connect the lead wire to the wire harness, and clamp it.

For detailed cable routing, refer to "CABLE ROUTING DIAGRAM"

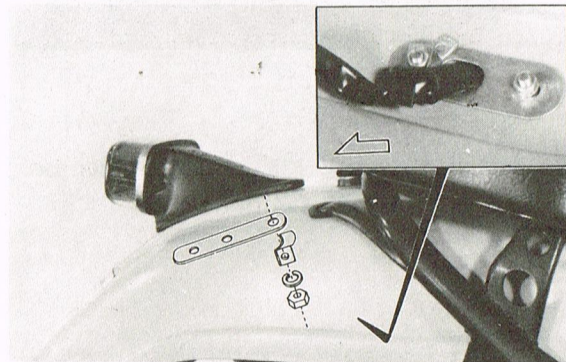

27. Install the seat using the hexagon bolts, plain washers and U-nuts.

Tightening torque:
0.7 m·kg (5 ft·lb)

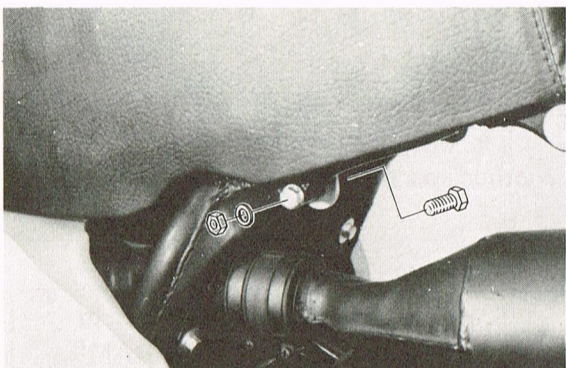

INSTALLATION OF THE OFF-ROAD RIDING KIT

An off-road riding kit is provided with each vehicle to comply with noise level and spark arrester laws and regulations. Performance will be substantially decreased. Retuning is not required.

Installing the kit parts.

1. Cylinder head gasket

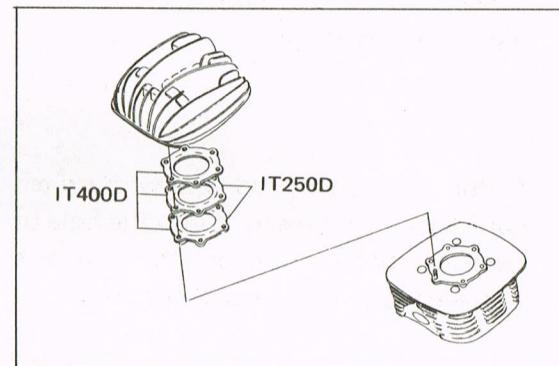

2. Choke plate

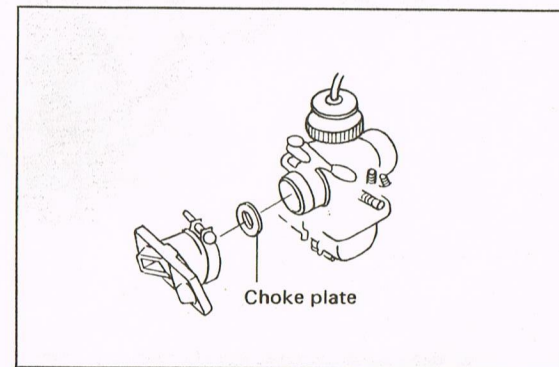

3. Main jet

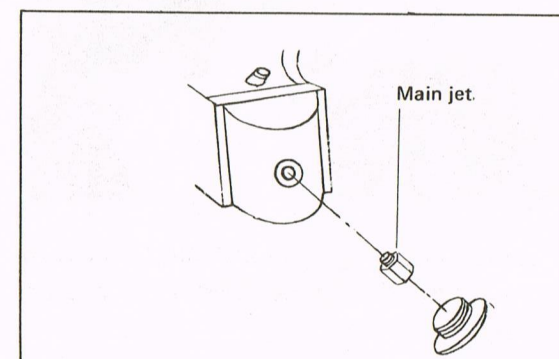

4. Choke pipe

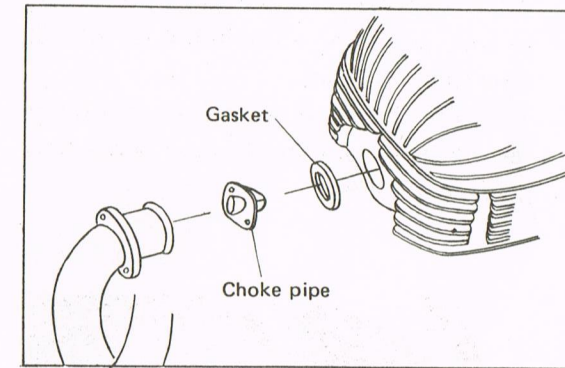

5. Silencer cap

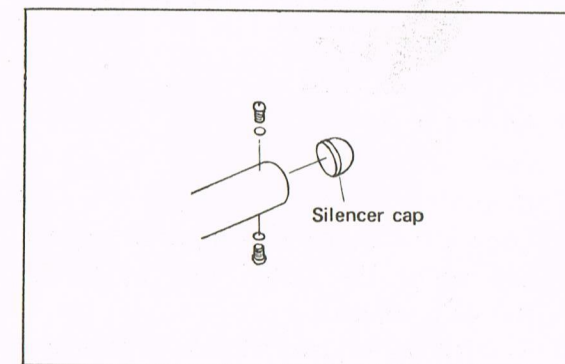

6. Absorber

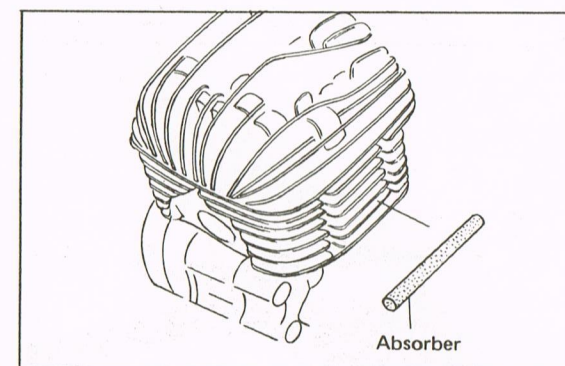

NOTE:
For details, refer to the owner's service manual for this model.

INSPECTIONS AND ADJUSTMENTS

Inspection

After all packed parts are installed, check to see that all these parts and other parts (mounted or installed at the Yamaha factory) are correctly mounted or installed, tightened or adjusted to specification. This check-up should be started with the front of the machine.

Item	
Front wheel spokes Tension
Front wheel rim Deflection
Front wheel tire Tire pressure
Front wheel axle nut Cotter pin, Tightening torque
Steering head Adjustment, Tightening torque
Handle holder Tightening torque
Clutch lever Free play, Tightening torque
Clutch wire Routing, Lubrication
Brake lever Free play, Tightening torque
Front brake wire Routing, Lubrication
Throttle wire Routing
Throttle housing Position, Operation, free play
Carburetor joints Tightness
Footrest Position, Tightness
Change pedal Tightness, Operation
Brake pedal Position, Free play, Operation
Seat Mounting
Fuel tank Fuel level, Mounting
Fuel pipe Clips, Connection

Fuel breather pipe	Routing, Connection
Rear fender	Mounting
Rear shock absorber	Cotter pin, Mounting
Rear Swing arm pivot shaft	Tightening torque
Rear axle nut	Tightening torque
Chain	Deflection, Cam position
Rear wheel	Spoke tension
Rear wheel rim	Deflection
Rear wheel tire	Tire pressure
Transmission	Oil level
Speedometer cable	Routing
Electrical components	Adjustment, Operation
Lead wires	Routing, Clamp

Adjustments

NOTE:
This section deals with the main points only. For details, refer to the service manual for this model.

1. Front brake

Loosen the brake wire adjuster locknut, and adjust the play of the brake lever to specification. After the adjustment, be sure to screw in the locknut until tight.

Free play: 5 - 8 mm (0.2 - 0.32 in)

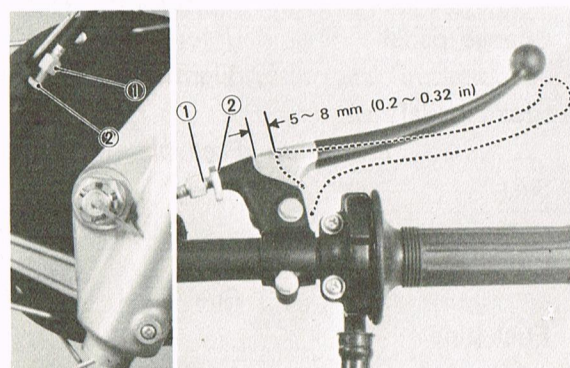

1. Adjustor 2. Locknut

2. Rear brake

Adjust the rear brake pedal free play to suit, providing a minimum of 20 - 30 mm (0.8 - 1.2 in). Turn the adjusting nut on the rear brake ferrule in or out until brake pedal free-play is suitable.

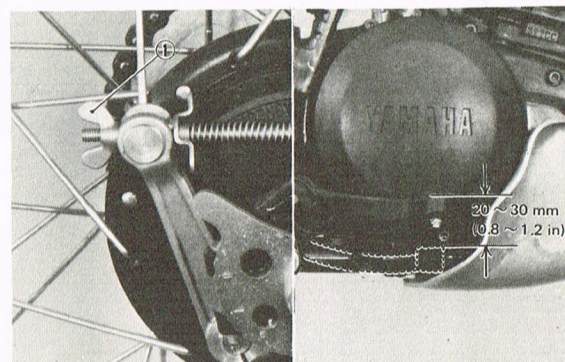

1. Adjusting nut

3. Clutch

Loosen the clutch wire adjuster locknut and adjust the clutch wire by turning the wire adjuster. Turning the adjuster clockwise (adjuster is tightened) increases clutch wire play. While turning counterclockwise decreases the play.

Free play:
2 - 3 mm (0.08 - 0.12 in)

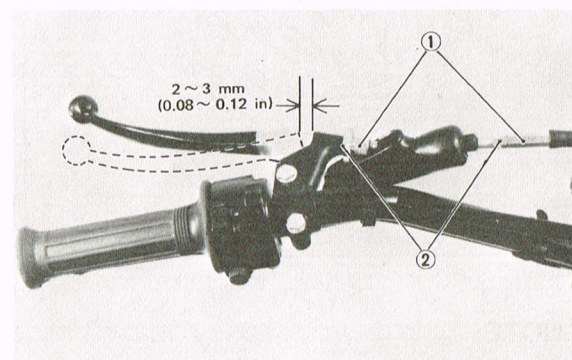

1. Adjustor 2. Locknut

4. Throttle

Check play in turning deflection of throttle grip. Play should be 5 - 7 mm (0.2 - 0.28 in) at grip flange. Loosen

the locknut and turn the wire adjustor to make the necessary adjustment. After adjusting, be sure to tighten the locknut properly.

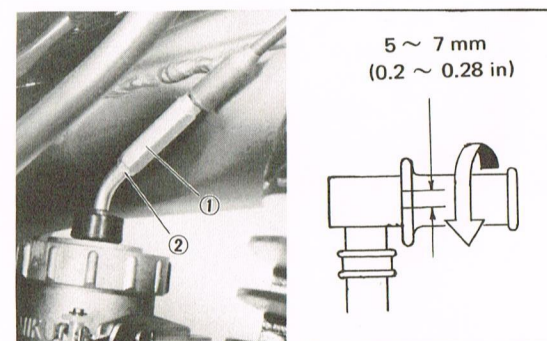

1. Adjustor 2. Locknut

Trouble shooting

If the engine will not start or will not start easily after inspections and adjustment, check the following parts.

1. Ignition timing — checking and adjustment

After starting the engine, check the ignition timing, and if necessary, adjust.

Ignition timing (B.T.D.C.):
IT250D 2.3 mm (0.091 in)
IT400D 2.7 mm (0.106 in)

2. Spark plug — Checking and adjustment

When the machine is stored or not used for a long period of time, the spark plug may get wet with oil. If so, hard starting will result, remove the spark plug, and clean as required.

Spark plug:
Type... IT250D: N-2G Champion
IT400D: N-3G
Gap..... 0.7 mm (0.028 in)

3. Carburetor — Cleaning

Remove the drain screw attached to the carburetor float bowl, and drain off the fuel. Add fresh fuel.

NOTE:

For details, refer to the owner's service manual for this model.