

GENUINE



**IT 175 E**

**OWNER'S/SERVICE MANUAL**

LIT-11626-00-84

BIN LOCATION	SHIPPED ITEM NUMBER	SHIPPED QTY
25-025-G-01-00	LIT-11626-00-84	1
DESCRIPTION	DEALER NO.	SHIP DATE
IT175E OWNER/SERV.	308000	04/06
-----	0303009	WHS BATCH
-----		33 013
-----		00 04 30

### IMPORTANT NOTICE

This motorcycle may be equipped either for competition use or general off-road use. It may be illegal to operate this vehicle off-road when it is equipped for competition use. Check your state and local riding area regulations. This vehicle is not manufactured for use on public streets, roads or high ways. Such use is prohibited by law. An off-road riding kit is provided with each vehicle to comply with noise level and spark arrester laws and regulations for installation instructions see directions in this manual. Performance will be substantially decreased.

### TO THE NEW OWNER

Yamaha's IT175E is designed and built for the rigors of off-road use. It offers many outstanding features not found on previous Yamaha machines. This owner's service manual provides the basic information for operation and proper care and maintenance. Careful attention to the procedures described in this manual will help insure trouble-free operation and optimum performance. Additional information regarding major repairs, such as crankcase disassembly, can be found in other publications available from your authorized Yamaha dealer.

#### IT175E OWNER'S SERVICE MANUAL

1st Edition - July 1977

2nd Printing - October 1979 JEM

ALL RIGHTS RESERVED BY  
YAMAHA MOTOR CORPORATION, U. S. A.  
BUENA PARK, CALIFORNIA 90620

**LIT-11626-00-84**



## CONTENTS

NOMENCLATURE .....	1
MACHINE IDENTIFICATION .....	2
CONTROL FUNCTIONS .....	3
PRE-OPERATION CHECKS .....	7
OPERATION .....	9
PERIODIC MAINTENANCE AND MECHANICAL ADJUSTMENT .....	11
ENGINE MAINTENANCE AND MINOR REPAIRS .....	34
CHASSIS MAINTENANCE AND MINOR REPAIRS .....	70
ELECTRICAL .....	87
CLEANING AND STORAGE .....	95
MISCELLANEOUS .....	98

## NOMENCLATURE

RIGHT SIDE

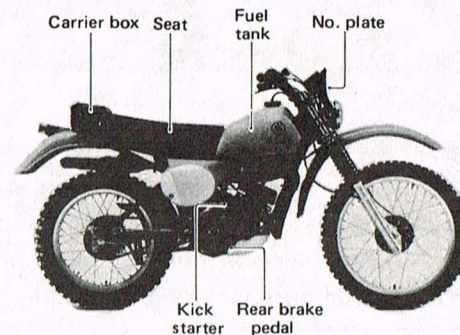

LEFT SIDE

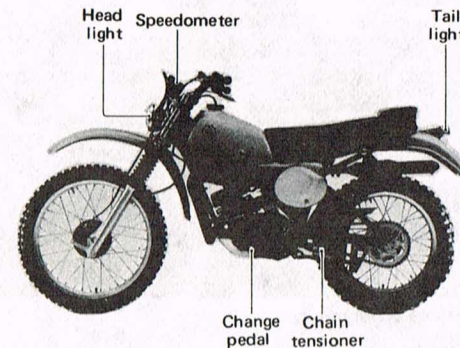



## MACHINE IDENTIFICATION

### Frame serial number

The frame serial number is stamped on the right side of the steering head stock.

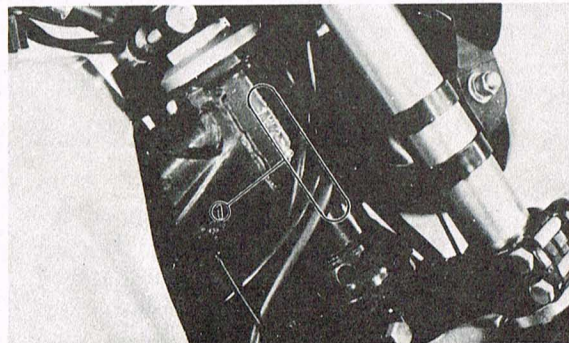

1. Frame serial number

### Engine serial number

The engine serial number is stamped into the raised part of the right rear section of the engine.

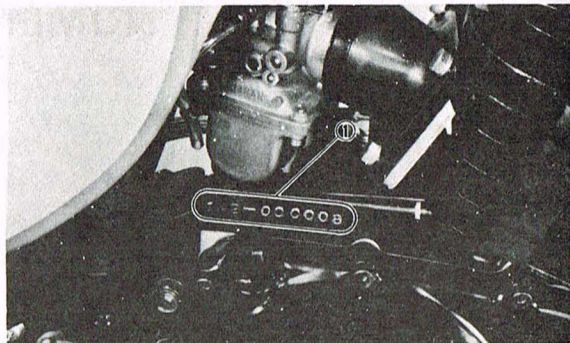

1. Engine serial number

### NOTE:

The first three digits of these numbers are for model identifications; the remaining digits are the unit production number. The engine and frame serial numbers are usually identical.

## CONTROL FUNCTIONS

### Handlebar switches

The handlebar switches are located here the left hand grip. They have the following functions.

### Engine stop button

The engine stop button is located on the left handlebar. Push and hold to stop the engine.

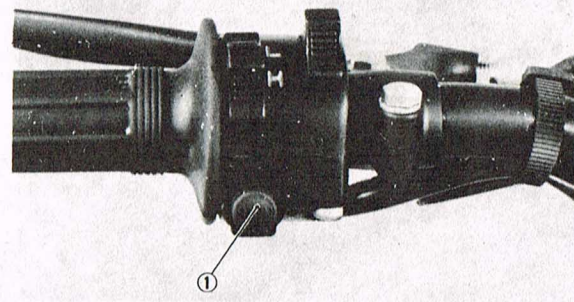

1. Engine stop button

### Lighting switch

If the light switch is turned forward, headlight and taillight come on.

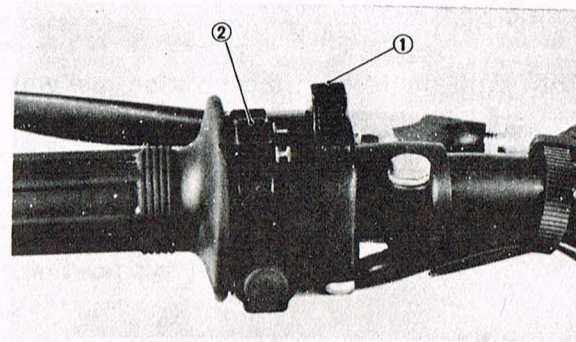

1. Lighting switch 2. Dimmer switch

### Dimmer switch

Turn to the "H" position for the high beam and to the "L" position for the low beam.



### Fuel petcock

The fuel petcock acts as a valve between the tank and the carburetor and also filters the fuel.

The fuel petcock has the following three positions:

**OFF:** With the lever in this position fuel will not flow. Return the lever to this position when the engine is not running.

**ON:** With the lever in this position fuel flows to the carburetor. Normal riding is done with the lever in this position.

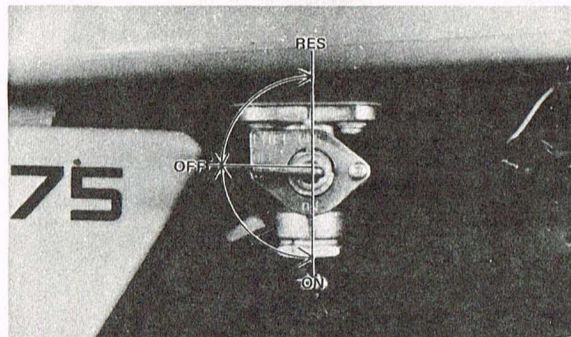

**RES:** This indicates "RESERVE". If you run out of fuel while riding, move the lever to this position. Then, fill the tank at the first opportunity.

### Gear shifting

The gear ratios of the constant mesh 6-speed transmission are ideally spaced. The gears can be shifted by using the change pedal on the left side of the engine.

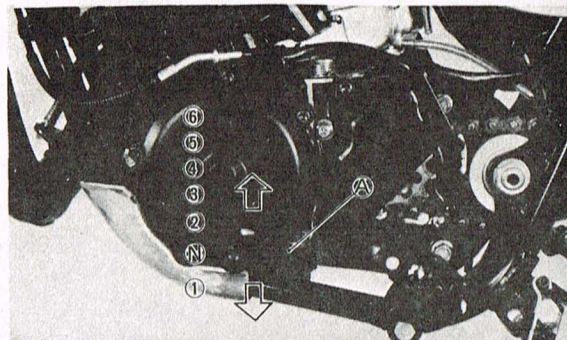

N. Neutral A. Change pedal

### Starter jet lever (CHOKE)

When cold, the engine requires a richer fuel mixture for starting. A separate starter circuit, which is controlled by the starter jet lever, supplies this mixture.

Push the lever down to open the circuit (for starting) and pull it up to close the circuit.

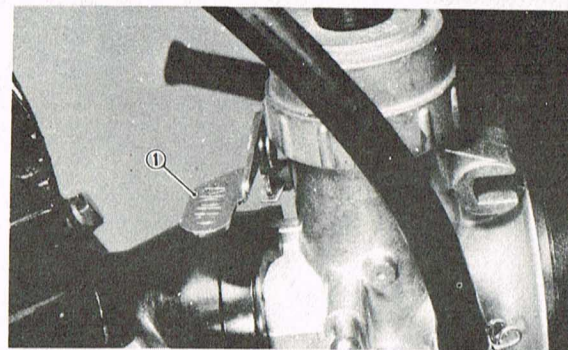

1. Starter jet lever

### Kick starter

To start the engine, rotate the kick crank, push down lightly with foot until gears engage, and then kick with full strength. This model has a primary kick starter so the engine can be started in any gear if the clutch is disengaged. As normal practice, however, shift to neutral before starting.

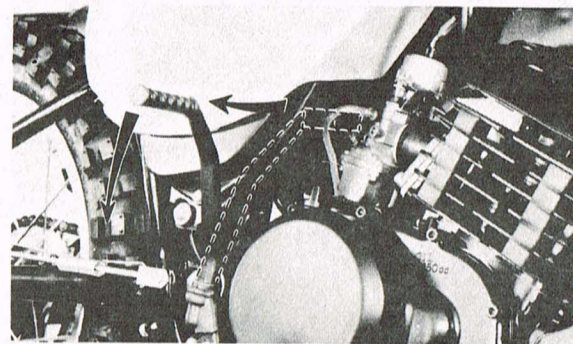



### Speedometer

The odometer and trip odometer are built into the speedometer. The trip odometer can be reset to "0" by turning the reset knob in the following two manners:

1. Turn the knob counter clockwise for resetting the entire place numbers to zeros.
2. Pull the knob and turn it either way for place-by-place reading adjustment.

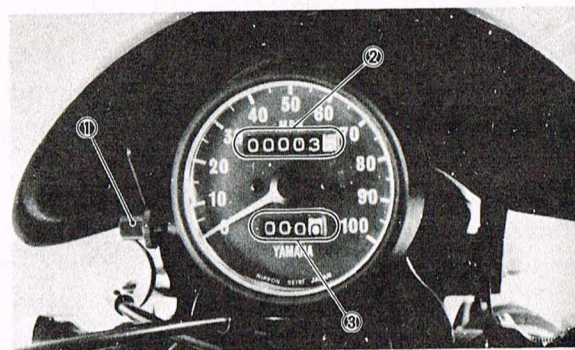

1. Reset knob
2. Odometer
3. Trip odometer

## PRE-OPERATION CHECKS

Before using this motorcycle please check the following points:

Item	Routine	Page
Brakes	Check operation/adjustment	26 ~ 28
Clutch	Check operation/lever adjustment	23 ~ 26
Transmission	Change oil as required	18, 19
Drive chain	Check alignment/adjustment/lubrication	28 ~ 31
Spark plug	Check each meet	19, 20
Throttle	Check for proper cable operation	22
Air filter	Foam type — must be clean and damp w/oil always	34 ~ 36
Wheels and tires	Check pressure/runout/spoke tightness/axle nuts	8, 70 ~ 76
Fittings/fasteners	Check all — tighten as necessary	—
Lights	Check operation	3

### NOTE:

Pre-operation checks should be made each time the machine is used. Such an inspection can be thoroughly accomplished in a very short time; and the added safety it assures is more than worth the time involved.



## Fuel

### Recommended fuel:

Premium gasoline (95 octan) mixed with recommended oil

Gasoline/oil mixing ratio: 20:1

Fuel tank capacity: 9.5 lit (2.5 U.S. gal)

### Recommended oil:

We recommended that your first choice be Yamalube "R" (2-cycle racing oil).

If for any reason you should use another type, the oil should meet or exceed BIA certification "TC-W". Check the container top or label for service specification and mixing ratios.

## Tires

Check the tire pressure and check the tires for wear.

### Tire pressure

Front	1.0 kg/cm <sup>2</sup> (14 psi)
Rear	1.2 kg/cm <sup>2</sup> (17 psi)

## Throttle grip

Turn the throttle grip to see if it operates properly and if the play is normal. Make certain the throttle springs closed when released.

# OPERATION

### CAUTION:

Before riding this motorcycle, become thoroughly familiar with all operating controls and their function.

Consult your Yamaha dealer regarding any control or function you do not thoroughly understand.

Lee Waldie Craig Scott Chris Koira

### WARNING:

This model is not equipped with highway approved lighting. This model is designed solely for competition use and should not be used on a street or highway at any time. In most instances, it is illegal to ride this model on any public street or highway.

## Starting a cold engine

1. Turn the fuel petcock to "ON".
2. Operate the carburetor starter jet (choke) lever and completely close the throttle grip.
3. Kick the kick crank with full strength to start the engine.
4. After the engine starts, warm up for one or two minutes. Make sure the starter jet (choke) lever is returned to the original position before riding.

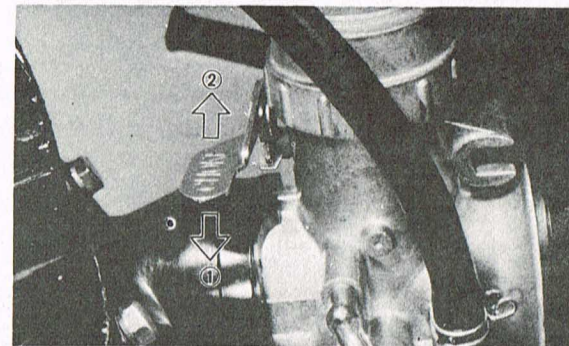

1. Open 2. Closed



### Starting a warm engine

To start a warm engine, refer to "Starting a cold engine" section; the starter jet (choke) lever should not be used, but the throttle should be opened slightly.

**CAUTION:**  
See "Break-in Section" prior to operating engine for the first time.

### Warming up

To get maximum engine life, always "warm-up" the engine before starting off. Never accelerate hard with a cold engine! To see whether or not the engine is warm, see if it responds to throttle normally with the starter jet (choke) turned off.

### Engine break-in

1. Prior to starting, fill tank with a break-in gasoline/oil mixture of 15 : 1.
2. Allow engine to warm up. Check engine idle speed. Check operating controls and engine stop button operation.
3. Operate machine in lower gears at moderate throttle setting for 3 ~ 5 minutes. Check spark plug condition.
4. Allow engine to cool. Repeat procedure, running for 5 minutes. Very briefly, shift higher gears (4th or 5th) and check full throttle response. Check spark plug condition.
5. Allow engine to cool. Repeat procedure, running for 5 minutes. Full throttle and higher gears may be used, but avoid sustained full throttle operation. Check spark plug condition.
6. Allow engine to cool. Remove "high" spots on piston with No. 600 grit, wet

- sandpaper. Clean, and carefully reassemble.
7. Remove break-in fuel/oil mixture from tank. Refill with 20 : 1 operation fuel/oil mixture. Check entire unit for loose or mis-adjusted fittings/controls/fasteners.
  8. Re-start engine and check through entire operating range thoroughly. Stop. Check spark plug condition. Restart. After 10 ~ 15 minutes operation, machine is ready for riding.

## PERIODIC MAINTENANCE AND MECHANICAL ADJUSTMENT

### Tool kit

The owner's tool kit contains the tools which enable the owner to perform simple adjustments or periodic maintenance.

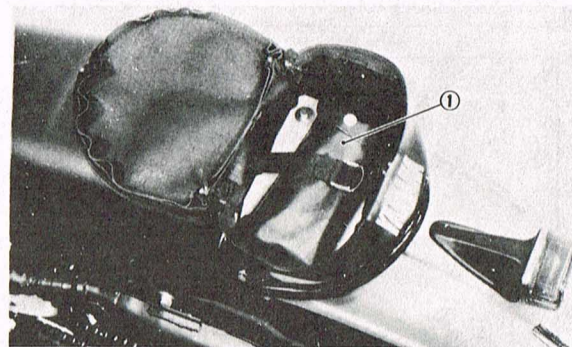

1. Tool kit



### Special tools

The maintenance procedures outlined within this manual require special tools and instruments. A comprehensive list of the special tools is given below.

Part name	No.	Part name	No.
1. Clutch holding tool	90890-01022	5. Pocket tester	90890-03096
2. Flywheel holding tool	90890-01235	6-a. Dial gauge	90890-03002
3. Flywheel puller	90890-01189	6-b. Dial gauge stand	90890-01039
4. Steering nut wrench	90890-01051	6-c. Dial gauge needle	90890-03042

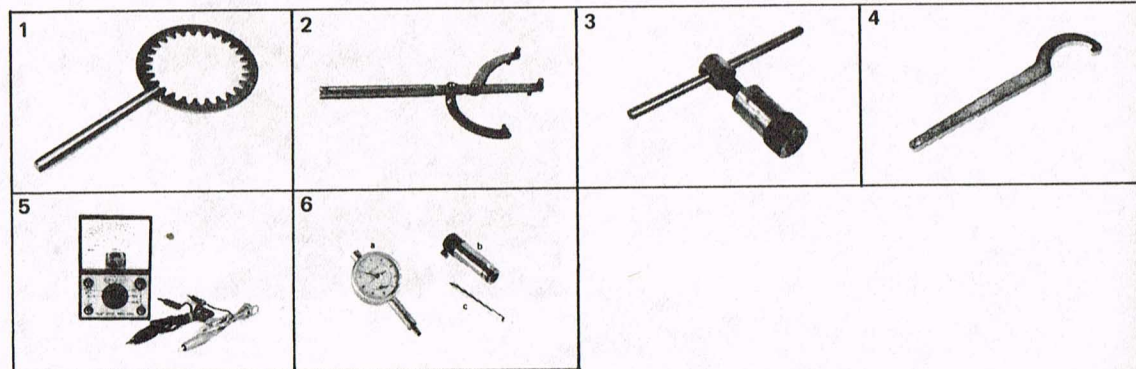

### PERIODIC MAINTENANCE

The maintenance and lubrication schedule chart should be considered strictly as a guide to general maintenance and lubrication intervals. You must take into consideration that weather, terrain, geographical locations, and a variety of individual uses all tend to demand that each owner alter this time schedule to match his environment. For example, if the motorcycle is continually operated in an area of high humidity, then all parts must be lubricated much more frequently than shown on the chart to avoid rust and damage. If you are to how closely you can follow these time recommendations, check with the Yamaha dealer in your area.



## MAINTENANCE AND LUBRICATION CHART

	After Every Ride	Every 500 km (300 Miles)	Every 1,300 km (800 Miles)	After Every Event (Competition)	As Required	Recommended lubricant type
WASH MACHINE	(This item is also essential to proper performance)				x	
<u>PISTON</u>						
Inspect		x		x		
Clean		x		x		
Replace					x	
<u>RINGS</u>						
Inspect		x		x		
Replace			x		x	
<u>CYLINDER</u>						
Inspect		x		x		
Head torque		x		x		
Replace					x	
<u>CLUTCH</u>						
Adjust					x	
Replace (Plates)					x	
<u>TRANSMISSION</u>						
Oil Change		x		x		NO.1
Inspect gears/ Shift mech.			x			
Replace bearings					x	

	After Every Ride	Every 500 km (300 Miles)	Every 1,300 km (800 Miles)	After Every Event (Competition)	As Required	Recommended lubricant type
<u>CRANKSHAFT</u>						
Main bearing check			x			
Big end check			x			
Small end check		x				
Piston pin check		x				
<u>CARB.</u>						
Clean, inspect, & adjust		x		x		
<u>EXHAUST SYSTEM</u>						
Inspect & tighten		x		x		
Clean and decarbonize					x	
<u>FRAME</u>						
Clean & inspect		x		x		
<u>SWING ARM</u>						
Check		x		x		
Lubricate					x	NO.5
<u>CONTROLS &amp; CABLES</u>						
Check & adjust	x					
Lubricate		x		x		NO.2
<u>BRAKES</u>						
Check & adjust		x		x		
Replace linings					x	



	After Every Ride	Every 500 km (300 Miles)	Every 1,300 km (800 Miles)	After Every Event (Competition)	As Required	Recommended lubricant type
<u>WHEELS &amp; TIRES</u> Check runout Check spokes Check bearings	x	x		x x x		
<u>STEERING HEAD</u> Check Clean, lube & repair		x		x	x	NO.6
<u>CDI</u> Check Connectors		x		x		
<u>AIR FILTER</u> Clean & oil Replace	x		x	x	x	NO.3
<u>SPARK PLUG</u> Check condition	x					
<u>DRIVE CHAIN</u> Clean & lubricate Check tension Replace	x x				x	NO.2
<u>FUEL TANK</u> Clean & flush Clean Petcock filter		x	x	x x		

	After Every Ride	Every 500 km (300 Miles)	Every 1,300 km (800 Miles)	After Every Event (Competition)	As Required	Recommended lubricant type
<u>REAR SHOCK</u> Clean & inspect		x		x		
<u>FRONT FORKS</u> Clean & change oil Replace seals		x		x	x	NO.4
<u>CLUTCH &amp; BRAKE</u> <u>SHAFTS</u> Lubricate		x		x		NO.5

RECOMMENDED LUBRICANT: \_\_\_\_\_

- No. 1 Use Yamalube 4-cycle oil or SAE 10W/30 "SE" motor oil.
- No. 2 1. Use YAMAHA CHAIN/CABLE LUBE.  
2. Use SAE 10W/30 "SE" motor oil. (If desired, specialty lubricants of quality manufacture may be used.)
- No. 3 Air filter: Foam element air filter must be damp with oil at all times to function properly. Clean and lube every meet and every ride. Do not over-oil. Use 2-stroke engine oil.
- No. 4 Use Yamaha Fork Oil #20.
- No. 5 Use lithium-base grease.
- No. 6 Medium-weight wheel bearing grease of quality manufacturer-preferably waterproof.



## Transmission oil

The transmission filler plug is located above the kick starter.

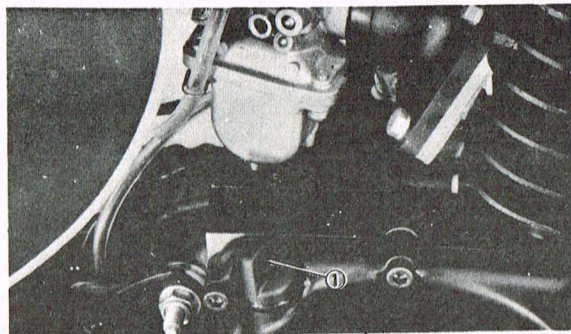

1. Filler plug

### Recommended oil:

Yamalube 4-cycle oil or  
SAE 10W/30 "SE" motor oil

On the bottom of the engine there is a drain plug. Remove it and drain all the oil from the

transmission. Reinstall the drain plug (make sure it is tight). Add oil through filler hole.

### Periodic oil change:

600 ~ 700 cc (36.6 ~ 42.7 cu-in)

### Engine overhaul:

700 ~ 800 cc (42.7 ~ 48.8 cu-in)

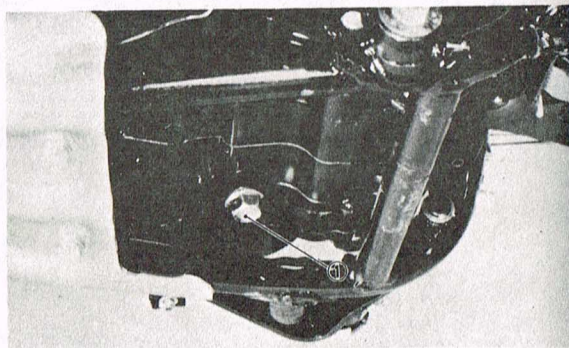

1. Drain plug

### Drain plug torque:

2.0 m-k (14.5 ft-lb)

On the right side of the engine there is a checking screw. To check, warm up the engine for 2 – 3 minutes. Place the motorcycle upright and remove the oil level checking screw. If oil flows out, the oil level is correct. The transmission oil should be drained and refilled according to the maintenance and lubrication chart.

### NOTE:

Do not add any chemical additives. Transmission oil also lubricates the clutch and additives could cause the clutch to slip.

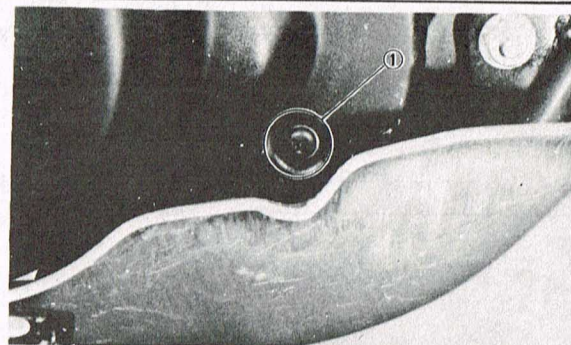

1. Checking screw

## Spark plug inspection

The spark plug is an important engine component and is easy to inspect. The condition of the spark plug can indicate something of the condition of the engine.

The ideal coloration on the white porcelain insulator around the center electrode is a medium to light tan color for a machine that is being ridden normally. If a spark plug shows a distinctly different color, there could be something wrong with the engine.

For example, a very white center electrode porcelain color could indicate an intake air leak or carburetion problem.

Do not attempt to diagnose such problems yourself. Instead, take the machine to your Yamaha dealer.

You should periodically remove and inspect the spark plug because heat and deposits will cause any spark plug to slowly break down and erode. If electrode erosion becomes ex-



cessive, or if carbon and other deposits are excessive, you should replace the spark plug.

Standard spark plug : N-2G (CHAMPION)

Before installing any spark plug, measure the electrode gap with a wire thickness gauge and adjust to specifications.

Spark plug gap: 0.7 mm (0.028 in)

When installing the plug, always clean the gasket seat surface and use a new gasket. Wipe off any grime from the threads and torque the spark plug properly.

Spark plug torque: 2.5 m·kg (18.1 ft·lb)

### Carburetor adjustment

The carburetor is a vital part of the engine and requires very sophisticated adjustment. Most adjustments should be left to a Yamaha dealer who has the professional knowledge and experience to do so. However, the following three points may be serviced by the owner as part of his usual maintenance routine.

1. Idle mixture adjustment
2. Idling speed adjustment
3. Throttle cable freeplay adjustment

### CAUTION:

The carburetor was set at the Yamaha factory after many tests. If the settings are improperly adjusted, poor engine performance and damage may result.

### Idle mixture adjustment

The idle mixture adjustment controls the amount of mixture to the engine at low rpm. The idle mixture also insures smooth transition to the main circuit with no power loss or misfire, so it does affect mid-range performance.

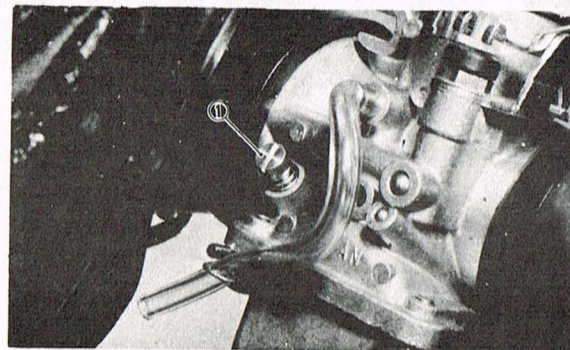

1. Pilot air screw

Make this adjustment as described below: Tighten the pilot air screw until it lightly touches the seat; then back the screw out as specified. This should be done with the engine stopped.

Standard pilot air screw setting  
(Number of turns out): 1-1/2

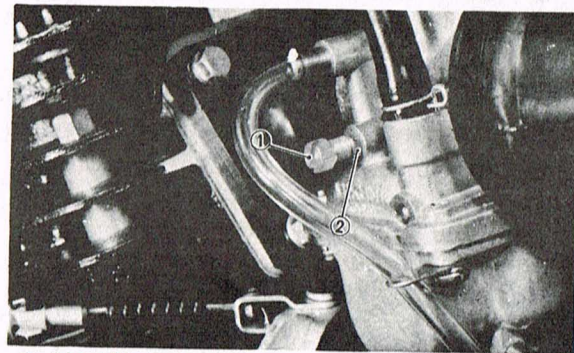

1. Throttle stop screw  
2. Lock nut



### Engine speed adjustment

Start the engine and warm it up for a few minutes. The warm up is complete when the engine responds quickly without dying. Normally 1 to 2 minutes is required; 2 to 3 minutes in cold weather. Turning the throttle stop screw counterclockwise lowers the engine speed. One clockwise turn from the engine stall position is considered to be the specified idling position.

Engine speed: As desired

### Throttle cable freeplay adjustment

Check play in turning direction of throttle grip. The freeplay should be 5 ~ 8 mm (0.2 ~ 0.3 in) at grip flange, loosen the lock nut and turn the adjuster to make the necessary adjustment. After adjusting, be sure to tighten the lock nut properly.

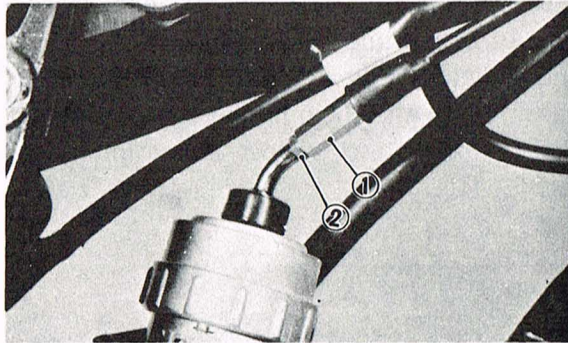

1. Adjuster  
2. Lock nut

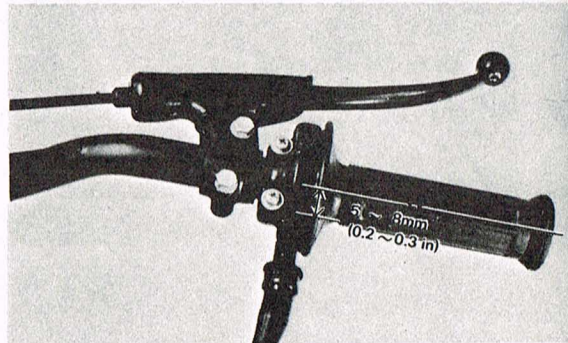

### Carburetor inspection

In addition to the above adjustment, check the following periodically:

1. Are the carburetor joint bands secure?
2. Is the overflow pipe or air vent pipe in place?
3. Is the mixing chamber top tight?

### Fuel petcock inspection and cleaning

The fuel petcock has a built-in filter to remove any particles before they reach the carburetor. If the filter becomes blocked, the fuel cannot enter the carburetor. To prevent this, inspection and cleaning should be done at recommended intervals.

- a. First turn the petcock lever to the "OFF" position; then remove the filter cup and clean the bottom of the cup with solvent.
- b. After removing the filter cup, remove and clean the filter screen. At the same time,

you should examine the condition of the "O"-ring. Replace if damaged.

- c. When reassembling, be careful not to clamp the filter cup too tightly as this may cause the "O"-ring to become unseated, resulting in fuel leakage.

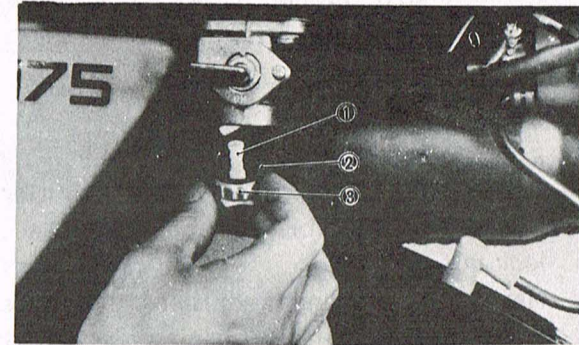

1. Filter screen 2. "O"-ring 3. Filter cup

### Clutch adjustment

This model has two clutch cable length adjusters and a clutch mechanism adjuster. Cable length adjusters are used to take up



slack from cable stretch and to provide sufficient freeplay for proper clutch operation under various operating conditions. The clutch mechanism adjuster is used to provide the correct amount of clutch "throw" for proper disengagement.

Normally, once the mechanism is properly adjusted, the only adjustment required is maintenance of freeplay at the clutch lever.

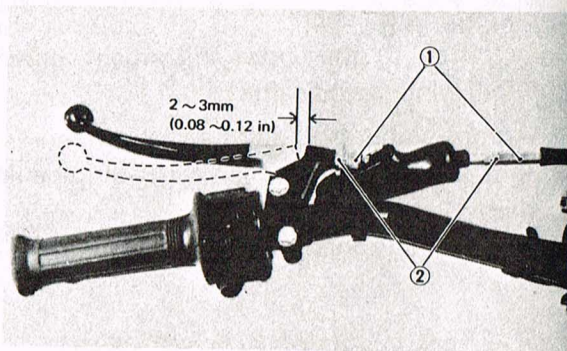

- 1. Adjuster
- 2. Lock nut

### 1. Freeplay adjustment

Loosen either the handle lever adjuster lock nut or the cable inline length adjuster lock nut.

Next, turn the length adjuster either in or out until proper lever freeplay is achieved (see illustration).

### 2. Mechanism adjustment

- a. Fully loosen the cable in-line length adjuster lock nut and screw in the adjuster until tight.

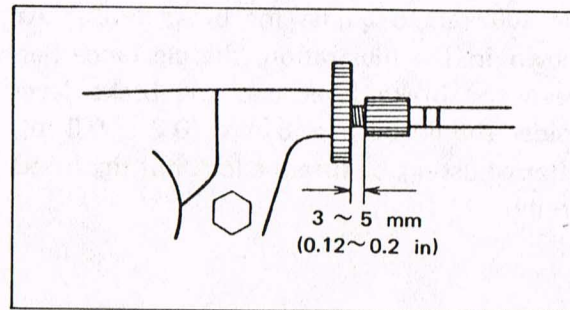

- c. Remove the brake rod and the tension spring on the brake rod.

Remove the engine protector, footrest and the kick crank.

- d. Drain the transmission oil and remove the crankcase cover (R).
- e. Loosen the clutch mechanism adjuster lock nut.

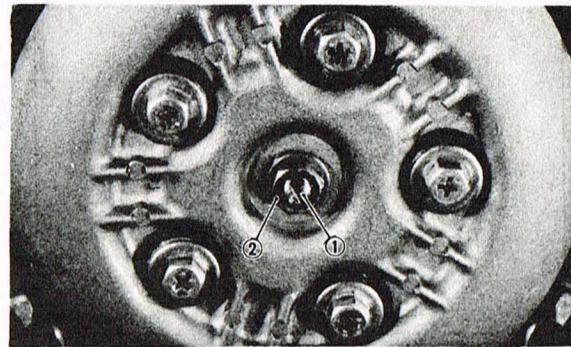

- 1. Adjuster
- 2. Lock nut

- f. Push the push lever toward the front with your finger until it stops. With the push lever in this position, turn the adjuster in until the push lever mark and crankcase match mark are aligned.



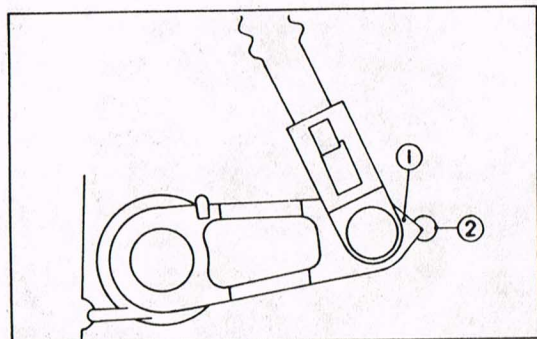

1. Push lever
2. Crankcase match mark

g. Re-adjust handle lever freeplay as required.

### Front brake adjustment

The front brake can be adjusted in two ways; (1) using the adjuster at the front brake lever or (2) at the front brake shoe plate. Adjustment at the front brake lever is normally recommended. Loosen the lock nut and turn

the adjuster to adjust the brake lever. As shown in the illustration, the clearance between the brake lever and the brake lever holder should be 5 ~ 8 mm (0.2 ~ 0.3 in). After adjusting, be sure the lock nut tightened firmly.

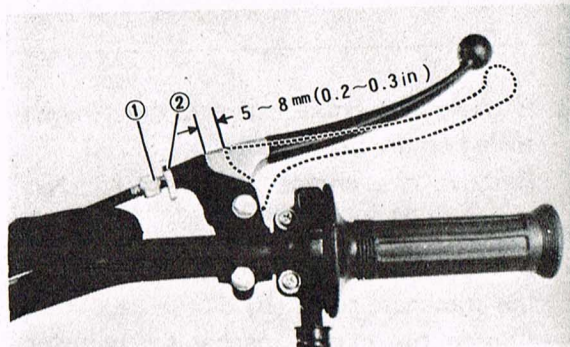

1. Adjuster
2. Lock nut

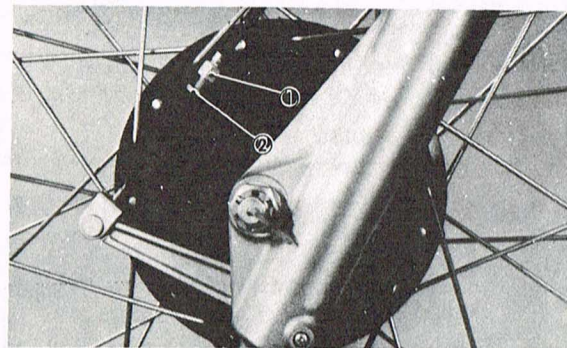

1. Adjuster
2. Lock nut

### Rear brake adjustment

The rear brake should be adjusted so the end of the brake pedal moves 20 ~ 30 mm (0.8 ~ 1.2 in). To adjust, turn the adjuster on the brake rod clockwise to reduce play; turn the adjuster counterclockwise to increase play.

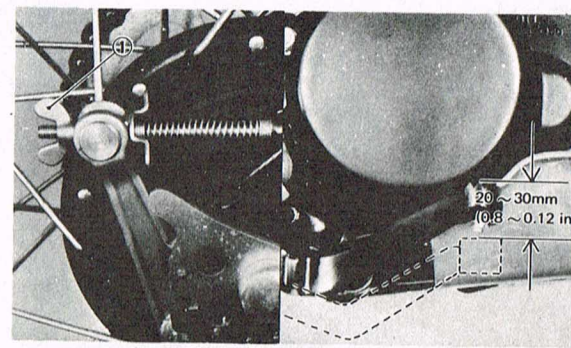

1. Adjuster

### Brake pedal position adjustment

The position of the rear brake pedal should be adjusted so as to suit the rider. Loosen the lock nut and adjust the pedal height by turning the adjuster.

After adjusting, check for correct rear brake play. Do not forget to tighten the lock nut.



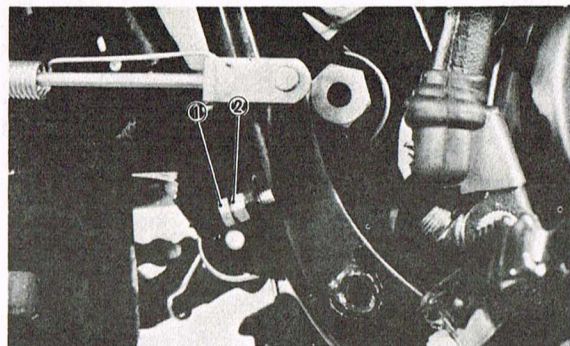

1. Adjuster
2. Lock nut

### Drive chain tension check

Inspect the drive chain with both tires touching the ground. Check the tension at the position shown in the illustration. The normal vertical deflection is approximately 40 ~ 50 mm (1.6 ~ 2.0 in). If the deflection exceeds 50 mm (2.0 in) adjust the chain tension.

**NOTE:** \_\_\_\_\_  
Tension inspection and adjustment should be made with the tensioner in the relaxed position. (not touching the chain)

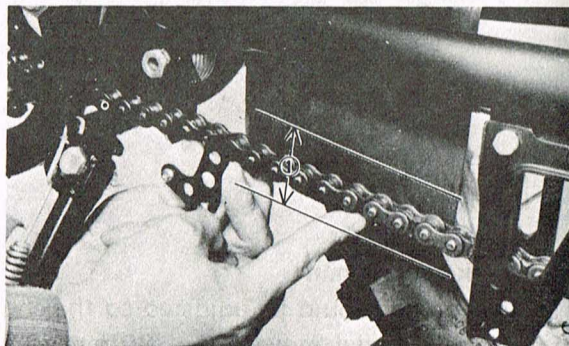

1. 40 ~ 50 mm (1.6 ~ 2.0 in)

### Drive chain tension adjustment

1. Remove the brake rod from the cam lever by compressing the rod's spring seat.

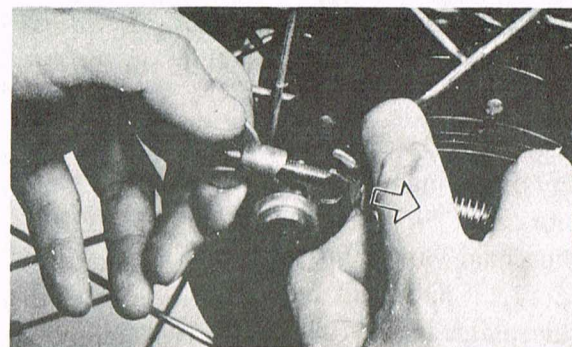

2. Remove the rear axle cotter pin.
3. Loosen the rear wheel axle nut.
4. Turn chain puller cam both left and right, until axle is situated in same cam slot position.

**NOTE:** \_\_\_\_\_  
Before adjusting, rotate rear wheel through several revolutions and check tension several times to find the tightest point. Adjust chain tension with rear wheel in this "tight chain" position.

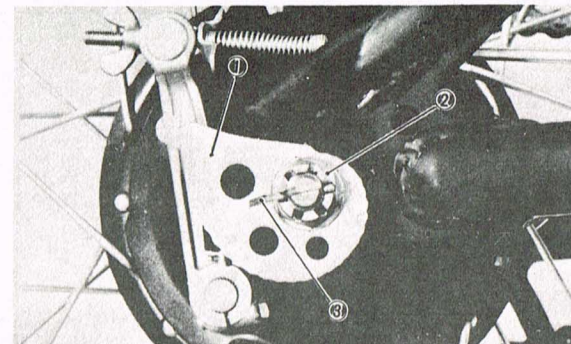

1. Chain puller cam
2. Axle nut
3. Cotter pin

5. Tighten the rear axle nut.

Axle nut torque: 10 m-kg  
(72 ft-lb)

6. Insert the new cotter pin into the rear wheel axle nut and bend the end of cotter pin. If the nut notch and pin hole do not match, tighten the nut slightly to match.
7. In the final step, adjust the play in the brake pedal.



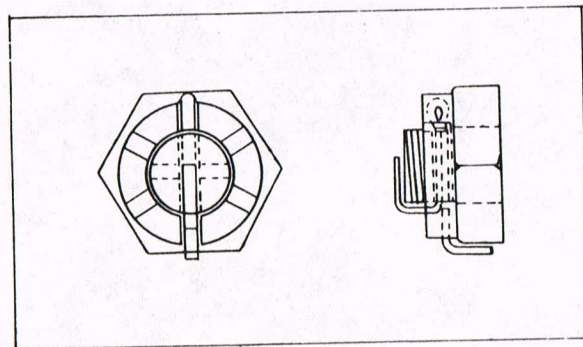

**NOTE:** \_\_\_\_\_

Excessive chain tension will overload the engine and other vital parts; keep the tension within the specified limits. Also, replace the rear axle cotter pin with a new one.

**Drive chain lubrication**

The chain consists of many moving parts. If the chain is not maintained properly, it will wear out rapidly. Form the habit of periodi-

cally servicing the chain. This service is especially necessary when riding in dusty conditions.

1. Use YAMAHA CHAIN/CABLE LUBE or any of the many brands of spray type chain lubricant. First, remove dirt and mud from the chain with a brush or cloth and then spray the lubricant between both rows of side plates and on all center rollers. This should be performed every 400 km (250 mi) or whenever the chain becomes dry.

2. To clean the entire chain, first remove the chain from the motorcycle, dip it in solvent and clean out as much dirt as possible. Then take the chain out of the solvent and dry it. After drying, lubricate the chain to prevent the formation of rust.

**Cable inspection and lubrication**

1. Damage to the outer housing of the various cables may cause corrosion and often free

movement will be obstructed. An unsafe condition may result so replace as soon as possible.

2. If the inner cables do not operate smoothly, lubricate or ask your Yamaha dealer to replace them.

Recommended lubricant:  
YAMAHA CHAIN/CABLE LUBE

**Throttle cable and grip lubrication**

The throttle twist grip assembly should be greased at the time that the cable is lubricated, since the grip must be removed to get at the end of the throttle cable. Two screws clamp the throttle housing to the handlebar. Once these two are removed, the end of the cable can be held high to pour in

several drops of lubricant. With the throttle grip disassembled, coat the metal surfaces of the grip assembly with a suitable all-purpose grease to cut down friction. (See lubrication chart.) A special cable lubricator attachment is available from your Yamaha dealer.

**Lubrication of levers, pedals, etc.**

1. Lubricate the pivoting parts of the brake and clutch levers with YAMAHA CHAIN/CABLE LUBE
2. Lubricate the shaft of the brake pedal with lithium base grease.



### Ignition timing

Ignition timing must be set with a dial indicator (to determine piston position). Proceed as follows:

1. Remove the muffler.
2. Remove spark plug and screw dial gauge stand into spark plug hole.
3. Insert dial gauge assembly into stand.

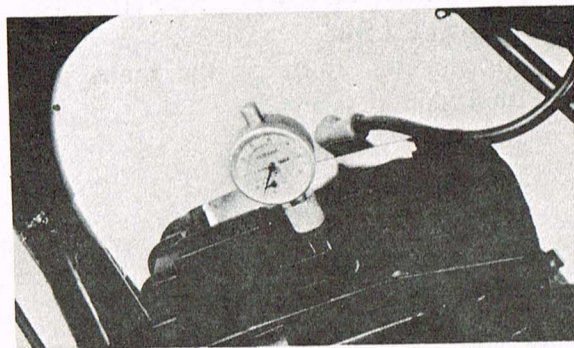

4. Remove left crankcase cover.

5. Rotate rotor until piston is at top-dead center (T.D.C.). Tighten set screw on dial gauge stand to secure dial gauge assembly. Set the zero on dial indicator face to line up exactly with dial indicator needle. Rotate flywheel back and forth to be sure that indicator needle does not go past zero.
6. Starting at T.D.C., rotate flywheel clockwise until dial indicator reads approximately 2.3 mm. (0.091 in).

Ignition timing:

$2.3 \pm 0.15$  mm ( $0.091 \pm 0.006$  in)

B.T.D.C.

7. Check the marks on the rotor and crankcase for alignment. If they are not aligned or a new crankcase is used for replacement, punch a new mark on the crankcase matching the one on the rotor.

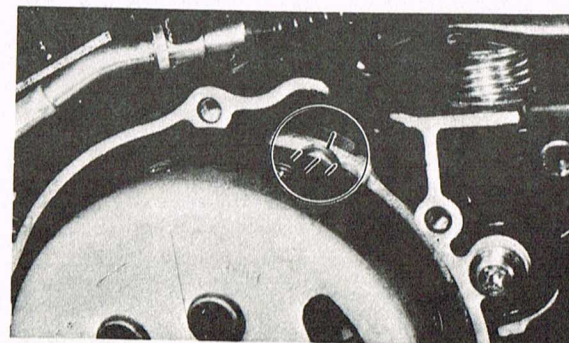

8. Check the alignment marks on the crankcase and stator for alignment. If they are not aligned, remove the rotor and loosen the two stator retaining screws. Rotate the stator until alignment is achieved. Retighten screws.

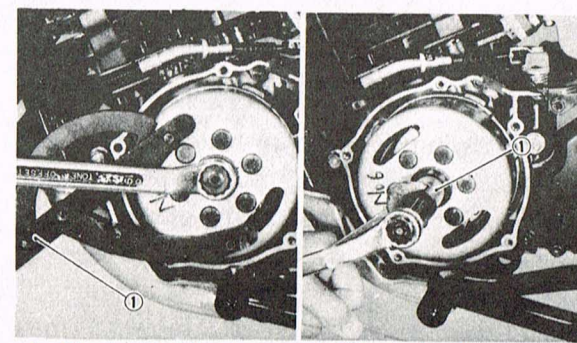

1. Flywheel holding tool

1. Flywheel puller

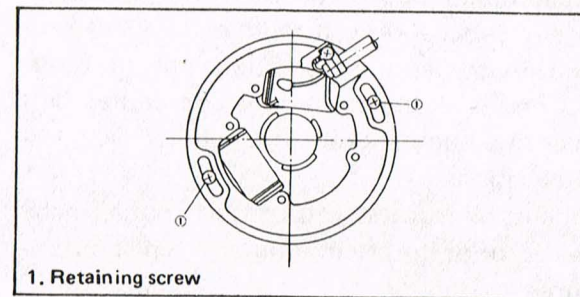

1. Retaining screw

9. Replace the rotor. Remove dial gauge assembly and stand. Reinstall spark plug, crankcase cover and muffler.



## ENGINE MAINTENANCE AND MINOR REPAIRS

The following sections provide information for the disassembly, troubleshooting and maintenance of various components of the machine. If you do not have the necessary tools and an understanding of the mechanical principles involved, please refrain from attempting repairs. The use of improper tools and/or procedures can cause major damage to units with resultant additional repair costs. To properly understand the procedures outlined, we suggest you consult other technical publications.

Finally, we suggest you consult your Yamaha dealer prior to attempting any repair procedures.

### Air filter

#### 1. Removal

- a. Remove the screw and remove the right number plate.
- b. Remove the screws (3) and filter case cover.

Lee Waldie Craig Scott Chris Koira

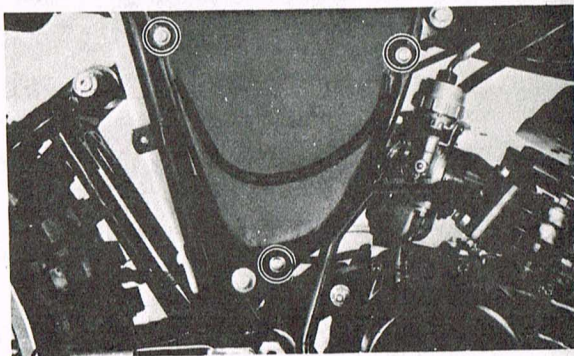

- c. Pull out the element from its case, remove element from guide.

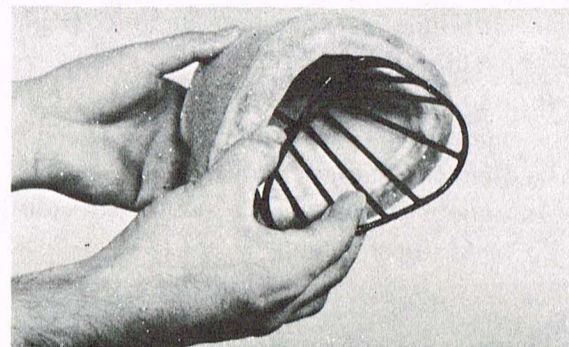

#### 2. Cleaning method

- a. Wash the element gently, but thoroughly, in solvent.
- b. Squeeze the excess solvent out of the element and let dry.
- c. Pour a small quantity of 2-stroke engine oil onto the filter element and work thoroughly into the porous foam material.
- d. Re-insert the element guide into the element.

#### NOTE: \_\_\_\_\_

In order to function properly, the element must be damp with oil at all times .... but not "dripping" with oil.

- e. Coat the sealing edges of the filter element with light grease. This will provide an air-tight seal between the filter case cover and filter seat.

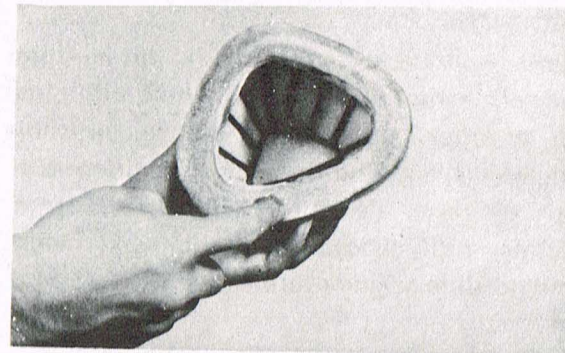

- f. Reinstall the element assembly and parts removed for access.



**NOTE:**

Each time filter element maintenance is performed, check the air inlet to the filter case for obstructions. Check the air cleaner joint rubber to the carburetor and manifold fittings for an air-tight seal. Tighten all fittings thoroughly to avoid the possibility of unfiltered air entering the engine.

**CAUTION:**

Never operate the engine with the air filter element removed. This will allow unfiltered air to enter causing rapid wear and possible engine damage. Additionally, operation without the filter element will affect carburetor jetting with subsequent poor performance and possible engine over-heating.

**Carburetor**

**1. Carburetor removal**

- a. Turn fuel petcock lever to the "OFF" position.
- b. Remove the gasoline tank fuel line from the fitting at the carburetor.
- c. Remove the right number plate.
- d. Loosen the manifold and inlet joint bands (hose clamps).

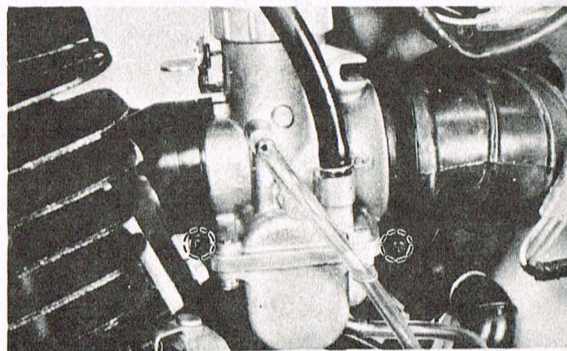

- e. Unscrew the mixing chamber top. Remove the throttle valve and needle assembly.

**NOTE:**

For carburetor main jet replacement only, follow steps "a" through "d" then:

- (1) Rotate carburetor, exposing main jet cover bolt (screw plug).
- (2) Remove the bolt. Main jet is located directly behind the bolt.

**WARNING:**

Removing the main jet cover bolt will allow the fuel in the float bowl to drain. Do not remove if engine is hot. Place a rag under carburetor to catch overflow. Remove bolt in well-ventilated area. Do not remove near open flame. Always clean and dry machine after reassembly.

- (3) Remove the main jet. Change as required. Reinstall cover bolt and reassemble, reversing steps 1 through 3.

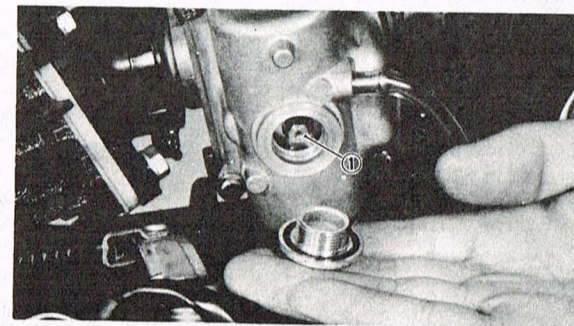

1. Main jet

MAIN JET : #360

- f. Push the air cleaner joint (hose) off the carburetor inlet.
- g. Rotating the carburetor body, work it off the cylinder manifold joint.
- h. Noting the presence, location, and routing of all vent and overflow tubes, pull the carburetor toward you.



## Carburetor

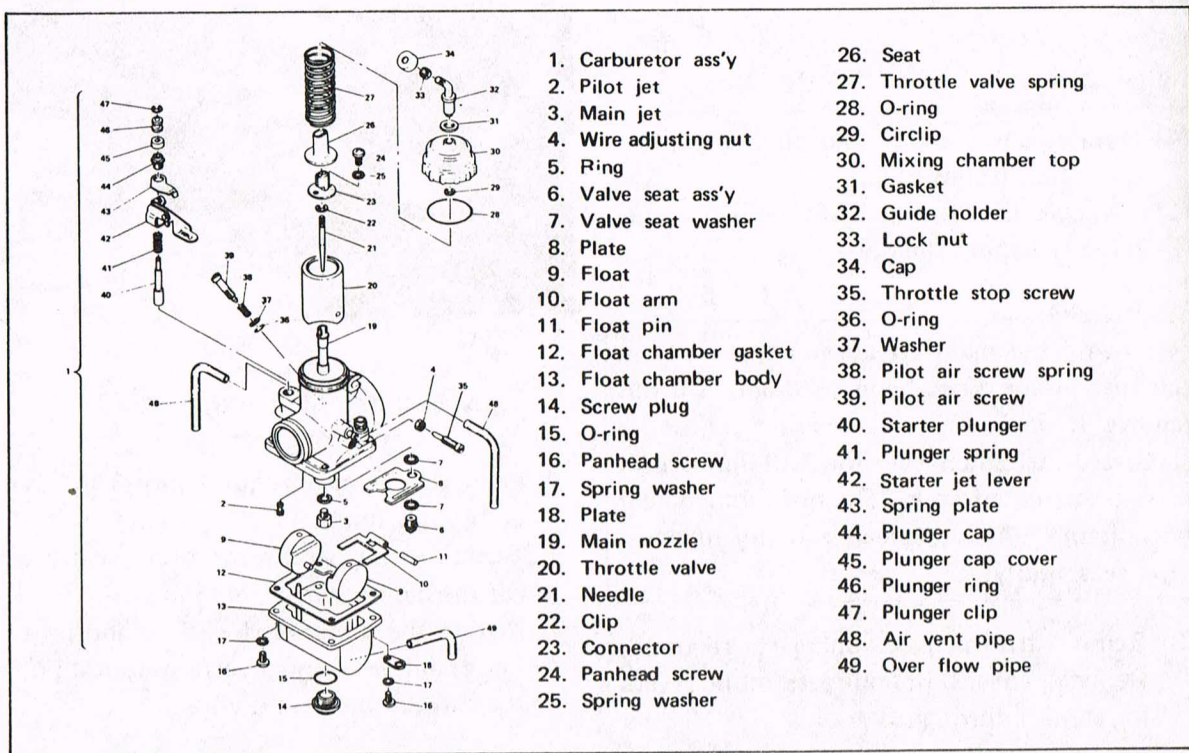

## 2. Carburetor disassembly and cleaning

- a. Remove the Phillips screws (4) holding float bowl to body. Remove float bowl.
- b. Carefully set body aside and inspect each independent float within the float bowl cavity. Note their installation position. The float arm pin must be on the lower side of the float and in, towards the center.
- c. Check each float. If fuel has entered a float, replace it. If a pin is loose or missing, or if the floats are damaged in any fashion, replace them.
- d. On the carburetor body, remove the pin securing the float arm. Remove the arm.
- e. Remove the inlet needle directly beneath the float arm tang. Inspect the needle and seat for signs of excessive wear or attached foreign particles. Replace as required. Replace inlet needle and inlet valve seat as an assembly.

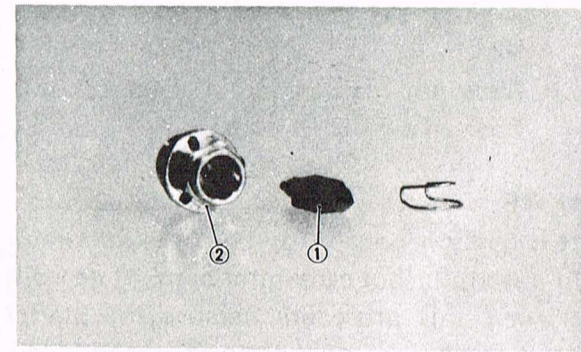

1. Needle valve  
 2. Valve seat

- f. Remove, in order, the following components.
  - (1) Main jet
  - (2) Pilot jet
  - (3) Main nozzle
  - (4) Throttle stop screw (Idle speed screw)
  - (5) Pilot air screw (Idle mixture screw)



- g. Actuate the starter jet control to open the circuit.
- h. Wash the carburetor in mild solvent. Wash all associated parts.

**NOTE:** \_\_\_\_\_  
 It is rarely necessary to "boil" the carburetor in a warm or hot carburetor bath. If deposits warrant this procedure, remove the Starter Jet Assembly to avoid damaging the jet's neoprene valve seat.

- i. Using high pressure air, blow out all passages and jets.

**CAUTION:** \_\_\_\_\_  
 Never direct high pressure air into carburetor with float bowl installed. Damage to floats may occur.

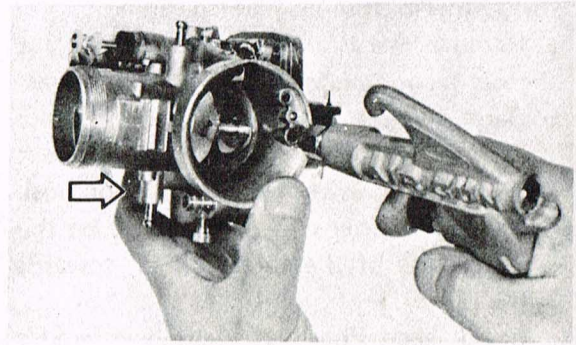

- j. Reinstall components, with the exception of the float bowl.

**3. Float arm height**

**a. Checking**

Hold the carburetor in an upside down position. While holding the float arm so the tang is just touching the float needle, measure the distance from the top of the float arm to the float bowl gasket surface.

**Float arm height:**  
 $23.5 \pm 1.5 \text{ mm } (0.93 \pm 0.06 \text{ in})$   
 Level with carburetor base

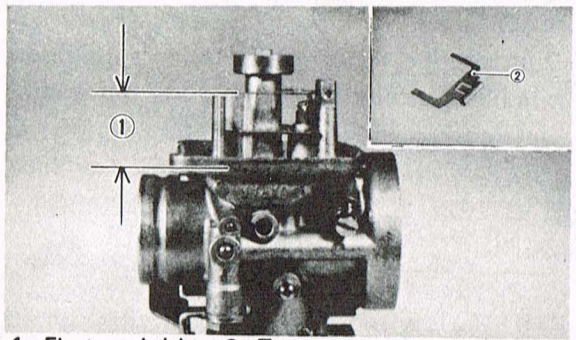

1. Float arm height 2. Tang

**b. Adjustment**

**CAUTION:** \_\_\_\_\_  
 Check the needle valve and valve seat for wear before adjustment.

Make the adjustment by bending the tang on the float arm.  
 Both arms must be the same height.

**4. Jet needle**

The mid-range air/fuel supply is affected by the position of the needle in the needle jet. If it is necessary to alter the mid-range air/fuel mixture characteristics of the machine, the jet needle position may be changed. Move the jet needle up for a leaner condition or toward the bottom position for a richer condition.

Jet needle type: 6F21  
 Clip position: No.3 Groove

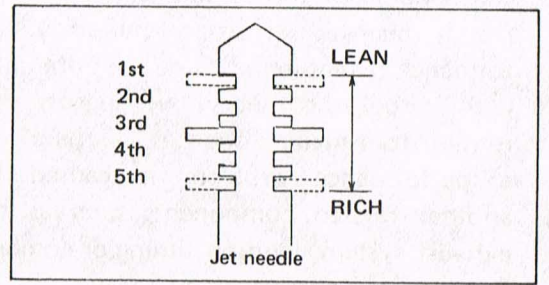



## 5. Troubleshooting

An enduro machine requires immediate, predictable throttle response over a wide operating range. Cylinder porting, combustion chamber compression ignition timing, muffler design, and carburetor size and component selection are all balanced to achieve this goal. However, variations in temperature, humidity and altitude, to name a few, will affect carburetion and consequently, engine performance.

The following list gives each of the major components of the carburetor that can be readily changed in order to modify performance if required. If you are unfamiliar with carburetor theory, we suggest you refrain from making changes. Quite often, a performance problem is caused by another related component, such as the exhaust system, ignition timing or combustion chamber compression.

### NOTE: \_\_\_\_\_

See MECHANICAL ADJUSTMENTS for additional carburetor adjustments.

### PILOT AIR SCREW: \_\_\_\_\_

Controls the ratio of air-to-fuel in the idle circuit. Turning the screw in decreases the air supply, giving a richer mixture.

OPERATING RANGE MOST AFFECTED BY THIS ADJUSTMENT: ZERO TO 1/8 THROTTLE.

### THROTTLE VALVE (Slide): \_\_\_\_\_

The throttle valve (slide) has a portion of the base cut away to control air flowing over the main nozzle. A wider angle (more "cutaway") will create a leaner mixture.

Throttle valves are numbered according to the angle of the cutaway. The higher the number the more cutaway, the leaner the mixture.

OPERATING RANGE MOST AFFECTED BY THE THROTTLE VALVE: 1/8 to 1/4 (+) THROTTLE.

### JET NEEDLE: \_\_\_\_\_

The jet needle is fitted within the throttle valve. The tapered end of the needle fits into the main nozzle outlet. Raising the needle allows more fuel to flow out of the nozzle outlet giving a richer mixture. There are five circlip grooves at the top of the needle. Moving the needle clip from the first, or top groove, through the fifth, or bottom groove, will give a correspondingly richer mixture. OPERATING RANGE MOST AFFECTED BY THE JET NEEDLE: 1/4 to 3/4 (+) THROTTLE.

### MAIN JET: \_\_\_\_\_

The main jet controls overall fuel flow

through the main nozzle. Changing the jet to one with a higher number supplies more fuel to the main nozzle, giving a richer mixture.

OPERATING RANGE MOST AFFECTED BY THE MAIN JET: 3/4 TO FULL THROTTLE.

### NOTE: \_\_\_\_\_

Excessive changes in main jet size can affect performance at all throttle positions.

### CAUTION: \_\_\_\_\_

**The fuel/air mixture ratio is a governing factor upon engine operating temperature. Any carburetor changes, whatsoever, must be followed by a thorough spark plug test.**

### Reed valve

1. With carburetor removed, remove the four (4) bolts holding the intake manifold and



reed valve assembly to the cylinder.  
Remove the reed valve assembly.

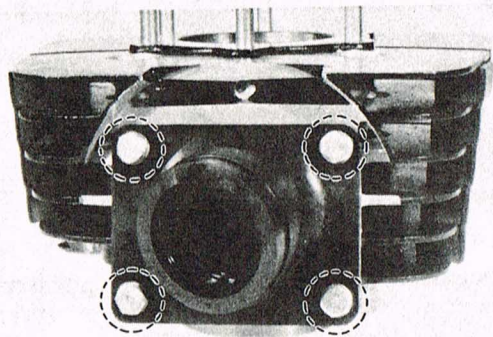

2. Inspect reed petals for signs of fatigue cracks. Reed petals should fit flush or nearly flush against neoprene seats. If in doubt as to sealing ability, apply suction to carburetor side of assembly. Leakage should be slight to moderate.
3. If disassembly of the reed valve assembly is required, proceed as follows.

- a. Remove phillips screws (3) securing stopper plate and reed to reed block. Handle reed carefully. Avoid scratches and do not bend. Note from which side of the reed block the reed and stopper plate were removed. Reinstall on same side.
- b. During reassembly, clean reed block, reed, and stopper plate thoroughly. Apply a holding agent, such as "Lock-Tite", to threads of phillips screws. Tighten each screw gradually to avoid warping. Tighten the screws thoroughly.

**CAUTION:** Do not over-tighten securing screws, stopper plates may warp.

Securing screw torque:  
8.0 cm-kg (6.9 in-lb)

**NOTE:** During reassembly, observe the cut in the lower corner of the reed and stopper plate. Use as aid to direction of reed installation.

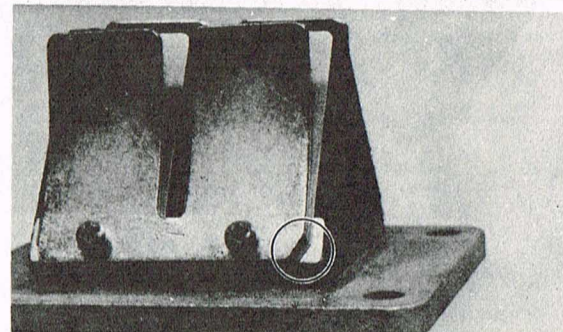

4. During reassembly of the reed valve assembly and manifold, install new gaskets and torque the securing bolts gradually and in pattern.

#### Top end and muffler

1. Muffler and cylinder head removal (Carburetor removed)
  - a. Remove the two bolts and seat.

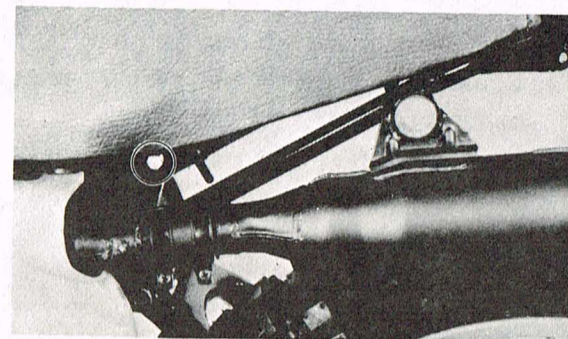

- b. Turn fuel petcock to the "OFF" position and disconnect fuel pipe.
- c. Remove the two bolts and tank fitting band.

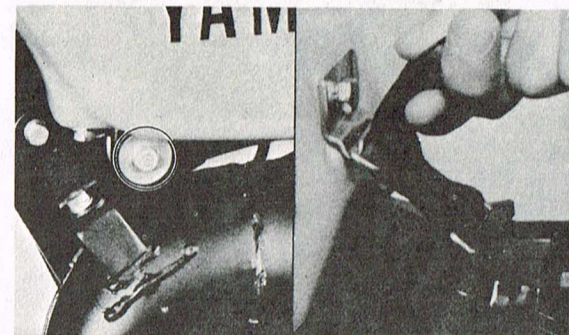



- d. Remove tank and left number plate.
- e. Loosen the muffler and silencer joint bands.
- f. Remove muffler and silencer mounting bolts. Remove silencer.

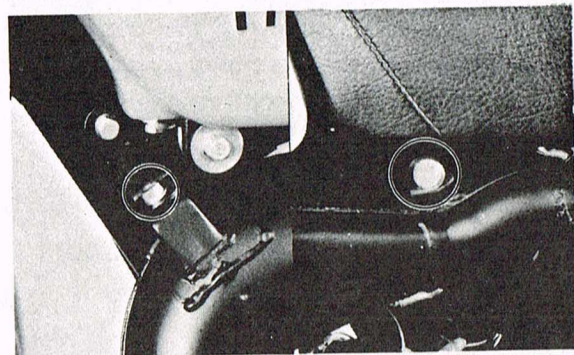
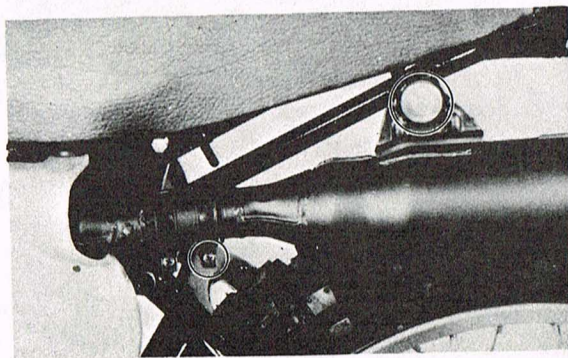

- g. Remove coil spring at muffler to cylinder joint. Remove muffler.

**NOTE:** \_\_\_\_\_  
 Remove the spark plug lead wire and spark plug before removing the muffler.  
 \_\_\_\_\_

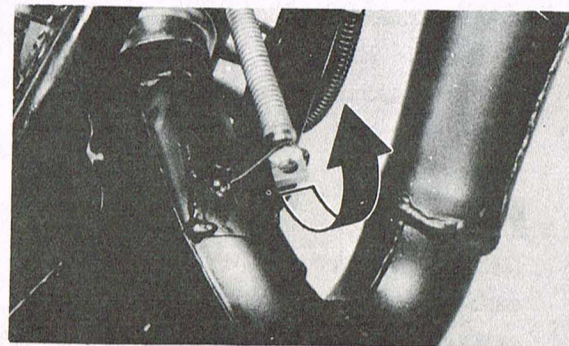

- h. Remove nuts securing cylinder and head. Remove cylinder head and gasket.

**NOTE:** \_\_\_\_\_  
 Break each nut loose (1/4 turn) prior to removing.  
 \_\_\_\_\_

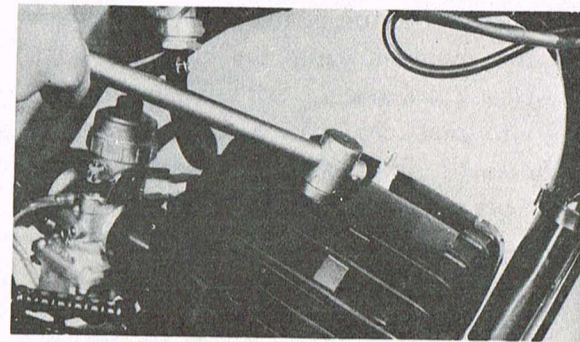

## 2. Cylinder removal

- a. Remove the cylinder holding nuts.

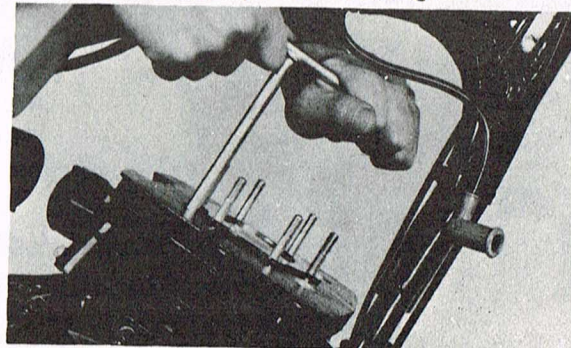



- b. With the piston at top dead center, raise the cylinder until the cylinder skirts clear crankcase. Stuff a clean shop rag into crankcase cavity, around rod, to prevent dirt and other foreign particles from entering. Remove cylinder.
- c. Remove the piston pin clip (1) from the piston. Push the piston pin out from opposite side. Remove the piston.

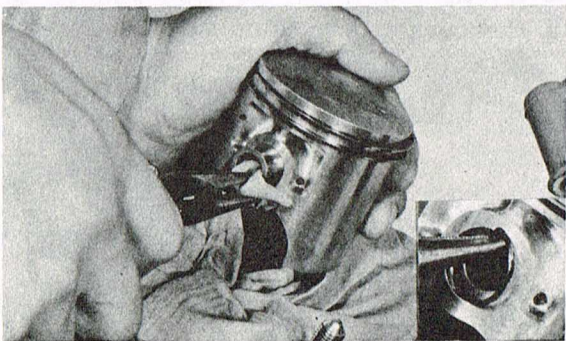

**NOTE:** \_\_\_\_\_  
 If the pin hangs up, use a piston pin puller. Do not hammer on pin as damage to rod, piston and bearing will result.

**3. Maintenance — Exhaust pipe**

- a. Using a rounded scraper, remove excess carbon deposits from manifold area of exhaust pipe. Check muffler gasket condition. The gasket seat is located around the cylinder exhaust port.
- b. Carbon deposits within the silencer may be removed by lightly tapping the outer shell with a hammer and then blowing out with compressed air. Heavy wire, such as a coat hanger, may be inserted to break loose deposits. Use care.
- c. Reinstall muffler.

**4. Maintenance — Cylinder head**

- a. Remove spark plug.

- b. Using a rounded scraper, remove carbon deposits from combustion chamber. Take care to avoid damaging the spark plug threads. Do not use a sharp instrument to avoid scratching the metal surface.

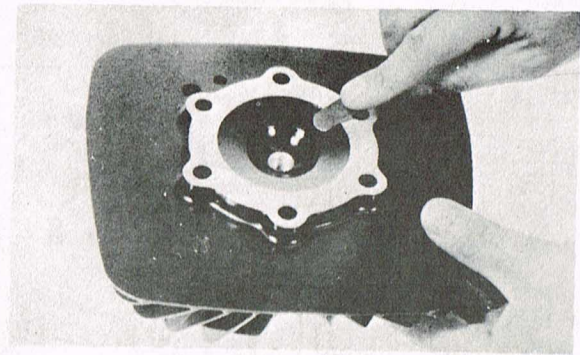

- c. Place the head on a surface plate. There should be no warpage. Correct by re-surfacing. Place 400-600 grit wet emery sandpaper on surface plate and re-surface head using a figure-eight sanding pattern. Rotate head several times to avoid removing too much material from one side.

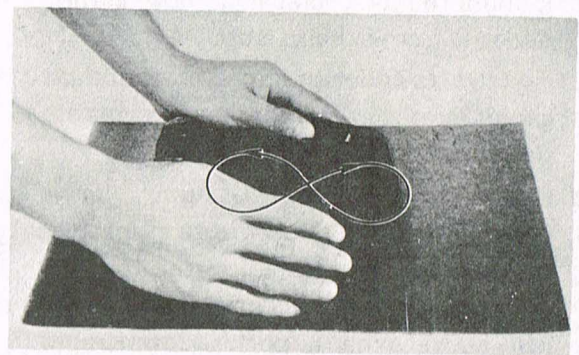



- d. Clean the spark plug gasket mating surface thoroughly.
- e. Wash the head in solvent and wipe dry.
- f. Install new cylinder head gasket during reassembly.

<p>Cylinder head nut torque: 2.5 m-kg (18.1 ft-lb)</p>
------------------------------------------------------------

#### 5. Maintenance – Cylinder

- a. Remove reed valve assembly.
- b. Using a rounded scraper, remove carbon deposits from exhaust port.
- c. Remove cylinder base gasket and clean gasket seat on cylinder and crankcase thoroughly.
- d. Check cylinder bore. Using a cylinder gauge set to standard bore size, measure the cylinder. Measure front-to-rear and side-to-side at top, center and bottom just above exhaust port. Compare to

piston a measurements. If over tolerance, and not correctable by honing, rebores to next over-size.

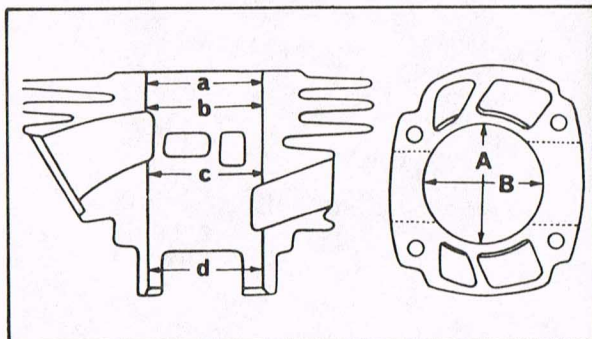
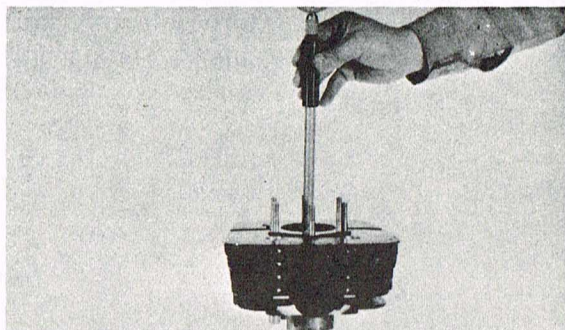

Standard bore:	66 mm (2.6 in)
----------------	----------------

Max. allowable taper:	0.05 mm (0.002 in)
-----------------------	--------------------

Max. allowable out-of-round:	0.01 mm (0.0004 in)
------------------------------	------------------------

- e. Clean cylinder in solvent, then wash with hot soapy water. Dry. Coat walls with light oil film.
- f. During re-assembly, always use a new cylinder base gasket.

#### 6. Maintenance – Piston

- a. Using a rounded scraper, remove carbon deposits from piston crown.
- b. Break a used piston ring in two. File end square. De-burr edges to avoid scratching ring groove and clean carbon deposits from ring grooves.

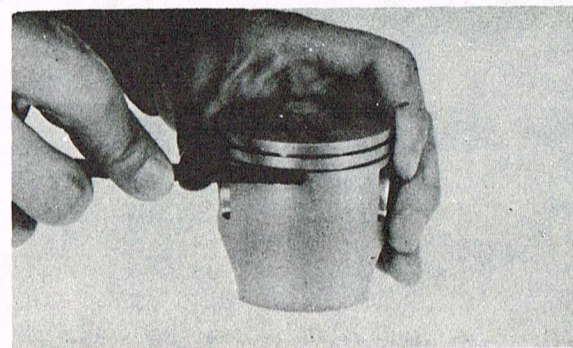

- c. Using 400-600 grit wet sandpaper, lightly sand score marks and lacquer deposits from sides of piston. Sand in crosshatch pattern. Do not sand excessively.





clearance. If beyond tolerance, replace piston or cylinder as required.

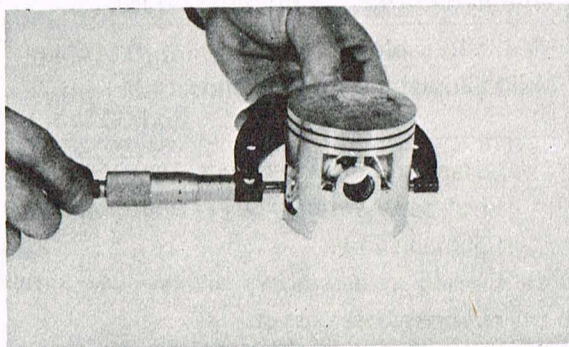

Nominal piston clearance:  
0.040 ~ 0.045 mm (0.0016 ~ 0.0018 in)  
Maximum wear limit:  
0.1 mm (0.004 in)

- d. Wash piston in solvent and wipe dry.
- e. Using an outside micrometer, measure piston diameter. The piston is cam-ground and tapered. The only measuring point is at right-angles to the piston pin holes about 10 mm (0.39 in) bottom of the piston skirts. Compare piston diameter to cylinder bore measurements (bottom two measurements at right angles to piston pin line). Piston maximum diameter subtracted from minimum cylinder diameter gives piston

- f. During re-assembly, coat the piston skirt areas liberally with two-stroke oil.
- g. Install new piston pin circlips and make sure they are fully seated in their

grooves.

- h. Take care during installation to avoid damaging the piston skirts against the crankcase as the cylinder is installed.

**NOTE:** \_\_\_\_\_

The arrow on piston dome must face forward.

- i. Make sure the rings are properly seated as the cylinder is installed.
7. Maintenance – Piston rings
- a. Remove the ring from piston.
  - b. Insert ring into cylinder. Push down approximately 20 mm (3/4 in) using piston crown to maintain right-angle to bore. Measure installed end gap. If beyond tolerance, replace.

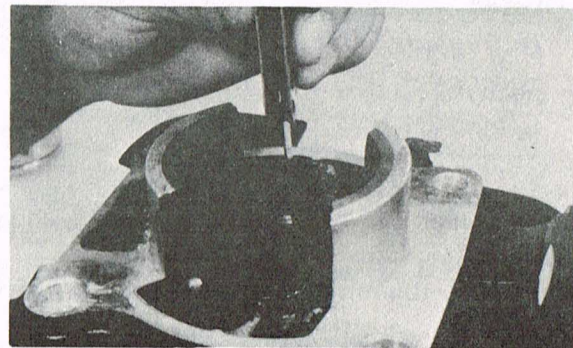

Ring end gap (installed):  
0.3 ~ 0.5 mm (0.012 ~ 0.02 in)

- c. Holding cylinder towards light, check for full seating of ring around bore. If not fully seated, check cylinder. If cylinder not out-of-round, replace ring.
- d. During installation, make sure ring ends are properly fitted around ring locating pin in piston groove. Apply liberal coating of two-stroke oil to ring.



**NOTE:**  
New ring requires break-in. Follow first portion of new machine break-in procedure.

8. Maintenance — Piston pin, bearing and connecting rod

- Check the pin for signs of wear. If any wear is evident, replace pin and bearing.
- Check the pin and bearing for signs of heat discoloration. If excessive (heavily blued), replace both.
- Check the bearing cage for excessive wear. Check the rollers for signs of flat spots. If found, replace pin and bearing.
- Apply a light film of oil to pin and bearing surfaces. Install in connecting rod small end. Check for play. There should be no noticeable vertical play. If play exists, check connecting rod

small end diameter and wear. Replace pin and bearing or all as required.

- Mount the dial gauge at right angles to the connecting rod small end. Holding the bottom of rod toward the dial indicator, rock top of rod and measure axial play.

Connecting rod axial play:  
0.8 ~ 2.0 mm (0.031 ~ 0.079 in)

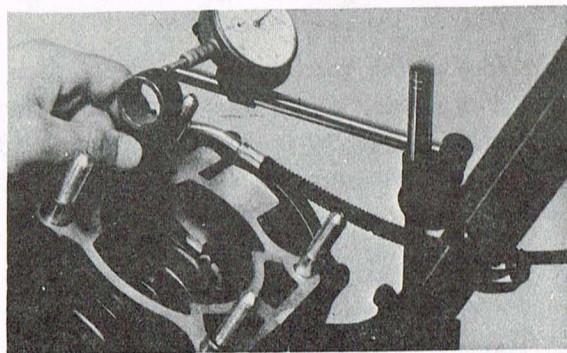

- Remove the dial gauge and slide the connecting rod to one side. Insert a feeler gauge between the side of the connecting rod big end and the crank wheel. Measure clearance.

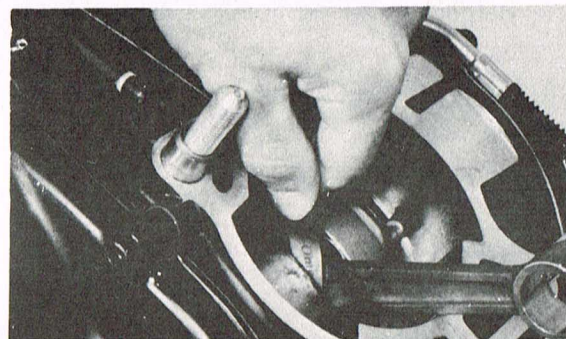

Lee Waldie Craig Scott Chris Koira

Connecting rod/crank side clearance:  
0.2 ~ 0.7 mm (0.008 ~ 0.028 in)

- If any of the above measurements exceed tolerance, crankshaft repair is required. Take the machine to your Authorized Yamaha Dealer.
- During reassembly, apply a liberal coating of two-stroke oil to the piston pin and bearing. Apply several drops of oil to the connecting rod big end. Apply several drops of oil into each crankshaft bearing oil delivery hole.

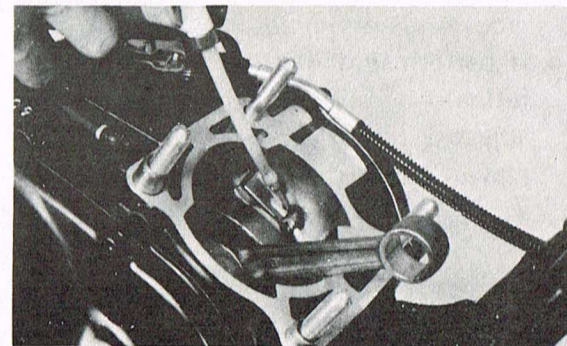



## 9. Troubleshooting — Top end and muffler

The following procedure will indicate if top end disassembly is required.

- a. Make a spark plug reading.
- b. Decarbonize muffler/spark arrester assembly. Remove cylinder head and make thorough visual inspection. Decarbonize cylinder head and piston crown. Take care that carbon does not drop into crankcase cavity or foul ring grooves. Reassemble.
- c. If performance is still poor, and carburetion and ignition systems are properly adjusted, piston and/or ring replacement may be required.

## Clutch, shifter and kick starter

**NOTE:** \_\_\_\_\_

Clutch adjustment is covered in Section "Mechanical adjustments"

---

### 1. Clutch removal

- a. Remove the kick crank and engine protector. Martin I Henry
- b. Remove the footrest retaining bolt and remove the footrest.
- c. Remove the brake rod from the cam lever by compressing the rod's spring seat. Remove the tension spring

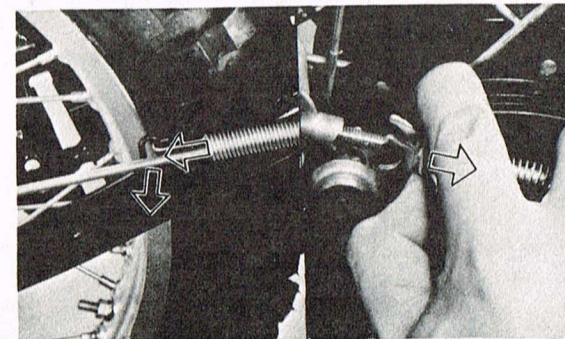

- d. Remove the allen bolts holding the crankcase cover in place and remove the cover. Note the position of the dowel pins.

**NOTE:** \_\_\_\_\_

Drain transmission oil before removing the cover.

---



## Clutch

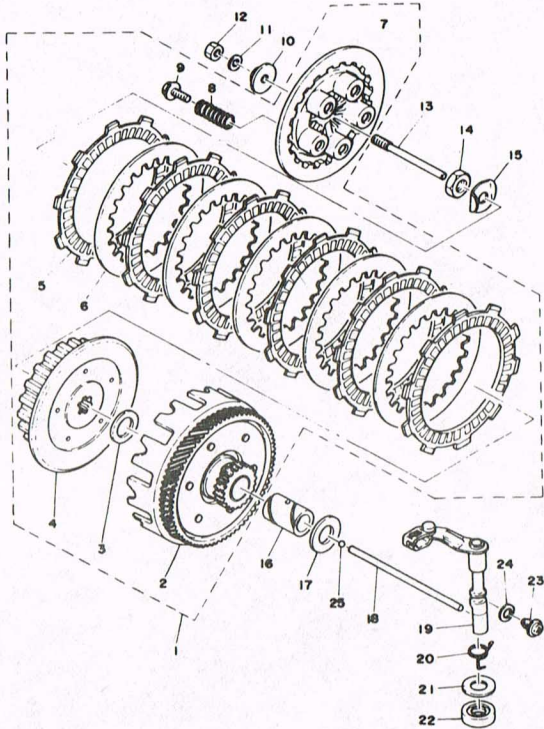

1. Clutch ass'y
2. Primary driven gear comp
3. Plate washer
4. Clutch boss
5. Friction plate
6. Clutch plate
7. Pressure plate
8. Compression spring
9. Screw with washer
10. Push plate
11. Plain washer
12. Hexagon nut
13. Push rod 1
14. Hexagon nut
15. Lock washer
16. Spacer
17. Plate washer
18. Push rod 2
19. Push lever ass'y
20. Torsion spring
21. Plate washer
22. Oil seal
23. Screw
24. Gasket
25. Ball

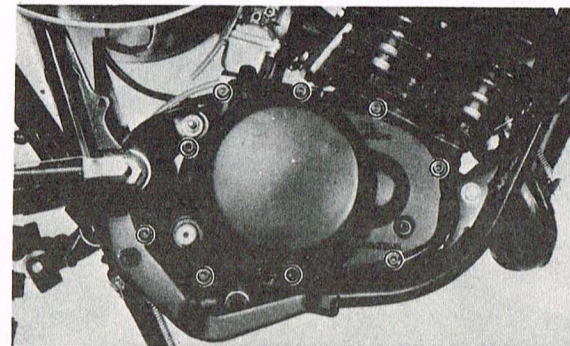

- e. Remove the Phillips screws (5) holding the pressure plate. Remove the clutch springs, pressure plate (with push rod 1), clutch plates and friction plates.

### NOTE:

When removing Phillips screws, loosen each screw in several stages working in a criss-cross pattern to avoid any unnecessary warpage. Note the condition of each piece as it is removed and its location with the assembly.

- f. Bend lock washer tab down.  
Using the clutch holding tool, remove the clutch securing nut and lock washer. Remove the clutch boss and driven gear (clutch housing).

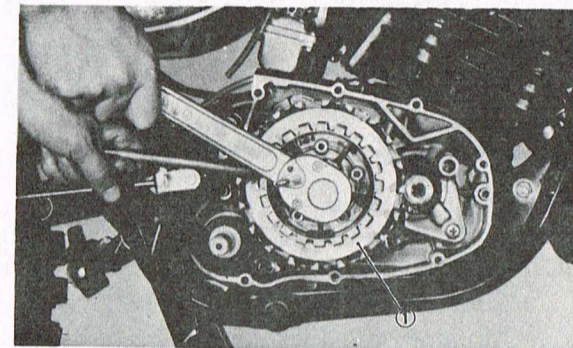

1. Clutch holding tool

- g. If the clutch housing spacer remains on the main axle, remove it.  
Remove the plate washer.
- h. Remove the circlip and then remove kick idle gear.



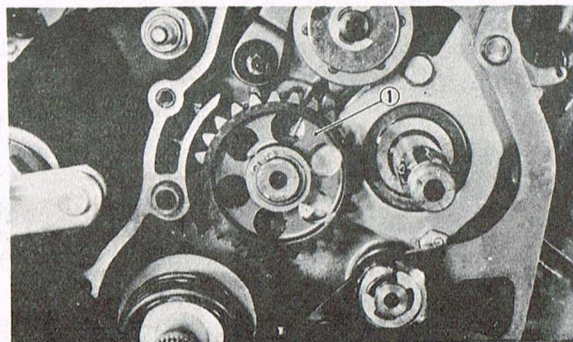

1. Kick idle gear

2. Kick starter

a. Removal

Unhook the kick spring from its post in the crankcase. Allow it to relax. Then remove the kick axle assembly by rotating the shaft counterclockwise and then pulling out the entire assembly.

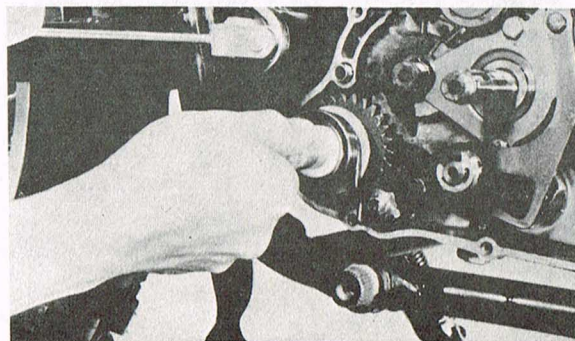

b. Check to see that the kick gear spirals freely on the worm shaft. Check the gear teeth for wear and breakage.

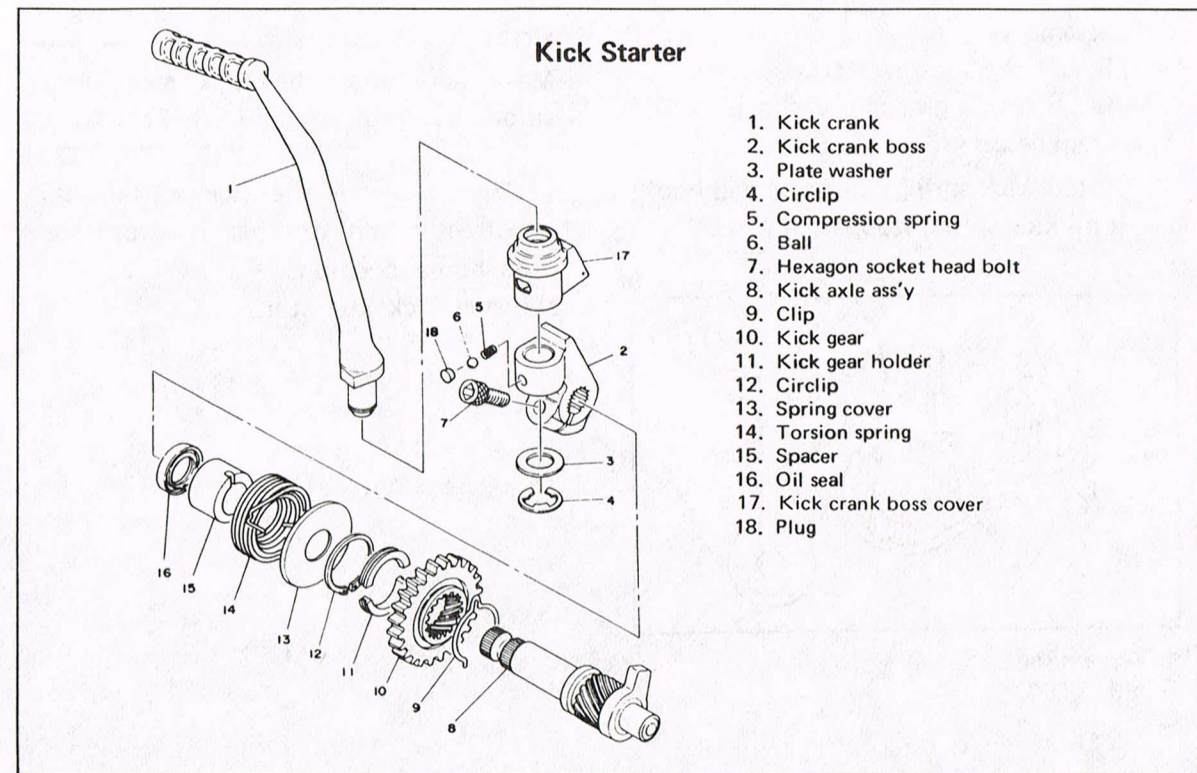



c. Reassembly

- 1) Install the kick starter assembly.  
Set the kick gear clip in the groove of crankcase.

Rotate kick spring clockwise and hook it on kick spring stopper.

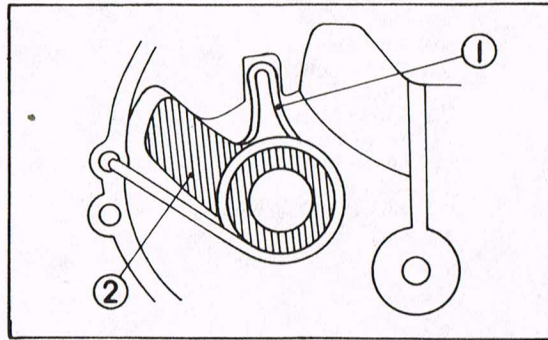

1. Kick gear clip
2. Kick stopper

**NOTE:** \_\_\_\_\_  
Make sure that the kick stopper is stopped at projection of crankcase.

- 2) Check whether the kick starter acts correctly and whether it returns to its home position.
- 3) Install kick idle gear.

3. Troubleshooting — Clutch assembly

- a. Measure the friction plates at three or four points. If their minimum thickness exceeds tolerance, replace.

	New	Wear limit
Friction plate thickness	3.0 mm (0.12 in)	2.7 mm (0.11 in)

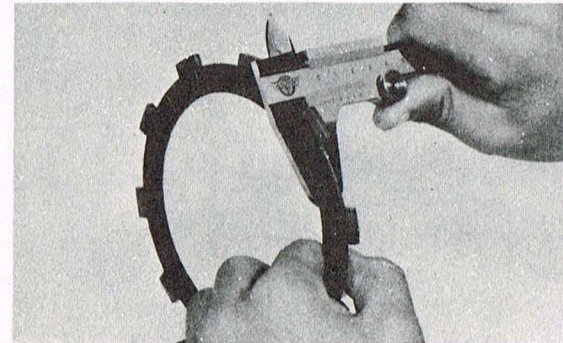

- b. Check the plates for signs of warpage and heat damage, replace as required.

**NOTE:** \_\_\_\_\_  
For optimum performance, if any plate requires replacement, it is advisable to replace the entire set.

- c. Check each clutch plate for signs of heat damage and warpage. Place on surface plate (plate glass is acceptable) and use feeler gauge.

Clutch plate warp allowance:  
Maximum 0.05 mm (0.002 in.)



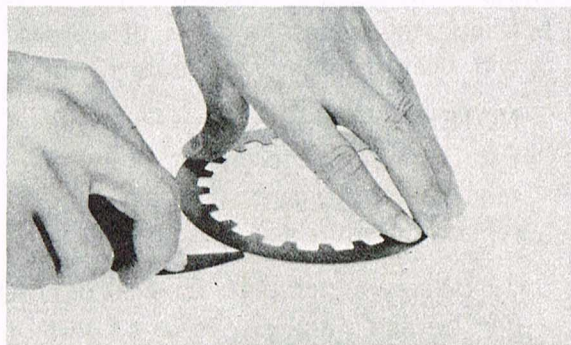

d. Thoroughly clean the clutch housing and spacer. Apply a light film of oil on the bushing surface and spacer. Fit the spacer into the bushing.

It should be a smooth, thumb-press fit. The spacer should rotate smoothly within the bushing. If necessary, replace spacer or clutch housing.

e. Check the bushing and spacer for signs of galling, heat damage, etc. If severe, replace as required.

f. Apply thin coat of oil on main axle and bushing spacer I.D. Slip spacer over main axle. Spacer should fit with approximately same "feel" as in clutch housing. Replace as required.

g. Check dogs on driven gear (clutch housing). Look for cracks and signs of galling on edges. If moderate, deburr. If severe, replace.

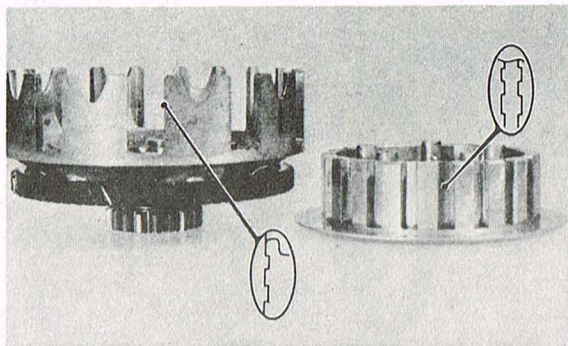

h. Check splines on clutch boss for signs of galling. If moderate, deburr. If severe,

replace.

**NOTE:** \_\_\_\_\_

Galling on either the friction plate dogs of the clutch housing or clutch plate splines of the clutch boss will cause erratic clutch operation.

i. Measure each clutch spring. If beyond tolerance, replace.

	New	Minimum
Clutch spring free length	36 mm (1.42 in)	35 mm (1.38 in)

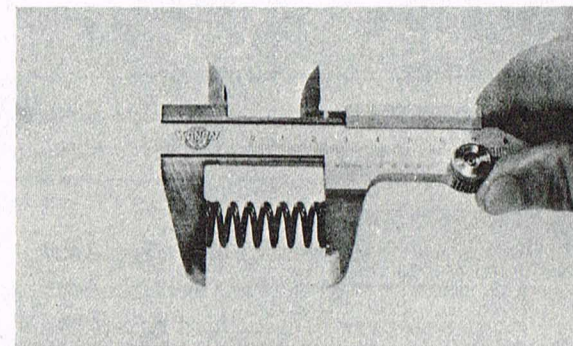

**NOTE:** \_\_\_\_\_

For optimum clutch operation it is advisable to replace the clutch springs as set if one or more are faulty.



#### 4. Shift Mechanism

##### NOTE:

Shifter maintenance and adjustment should be performed with clutch assembly removed.

##### a. Adjusting the gear shift arm

Adjusting or correcting the travel of the gear shift arm to prevent improper shifting progression (excess feed or insufficient feed of the gear shift arm) is accomplished by turning the gear shift return spring stop screw (eccentric screw) in or out. Set the low gear. Turn the eccentric screw in or out until the shift cam plate and the change lever marks coincide.

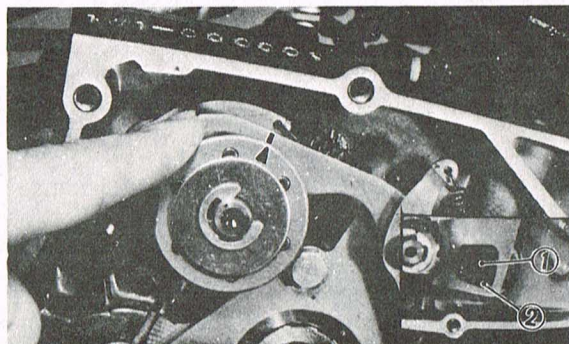

1. Eccentric screw
2. Lock washer

##### Drive and driven sprocket and chain

##### 1. Drive sprocket

- a. Using a blunt chisel, bend down the drive sprocket lock washer tab.
- b. With the drive chain in place, transmission in gear, firmly apply the rear brake.

Remove the sprocket securing nut.

Remove the sprocket.

- c. Check sprocket wear. Replace if wear decreases tooth height to a point approaching the roller center line.

- d. Replace if tooth wear shows a pattern such as that in the illustration.

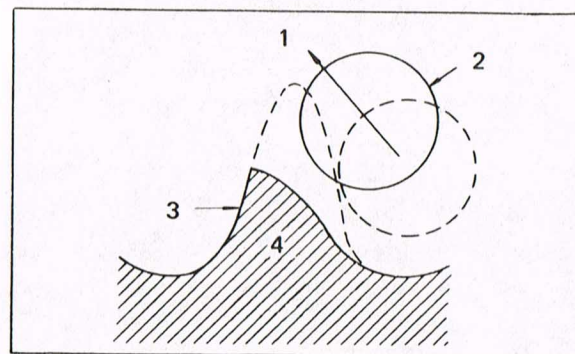

1. Slip off
2. Roller
3. Replace
4. Sprocket

- e. During drive sprocket reassembly, make sure the lock washer splines are properly seated on the drive shaft splines. Tighten securing nut thoroughly to specified torque value. Bend lock washer tab fully against securing nut flats.

Drive sprocket securing nut torque:  
6 m-kp (43 ft-lb)

##### 2. Driven sprocket

With the rear wheel removed, proceed as follows:

- a. Using a blunt chisel, bend down the securing bolt lock washer tabs. Remove the securing nuts (6). Remove the lock washers and sprocket.
- b. Check sprocket wear (see procedures for



the drive sprocket.)

- c. Check the sprocket to see that it runs true. If severely bent, replace.
- d. During reassembly, make sure the sprocket and sprocket seat are clean. Tighten the securing bolts in a crisscross pattern. Bend the tabs of the lock washers fully against the securing bolt flats.

Driven sprocket securing nut torque:  
4.5 m-kg (31 ft-lb)

### 3. Chain

**NOTE:** \_\_\_\_\_  
Refer to Maintenance and Lubrication Charts for additional information.

- a. Using a blunt-nosed pliers, remove the

master link clip and side plate. Remove the chain.

- b. Check the chain for stiffness. Hold as illustrated. If stiff, soak in solvent solution, clean with medium bristle brush, dry with high pressure air. Oil chain thoroughly. Don't skip a portion as this will cause uneven wear. Apply thoroughly. Wipe off excess.

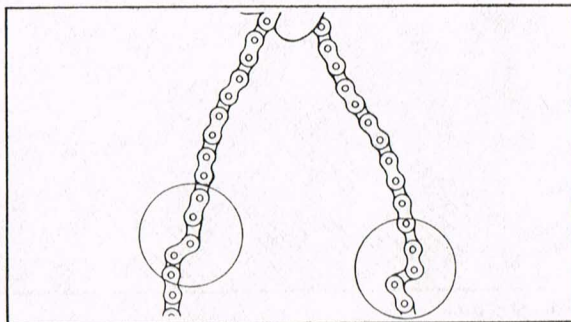

**NOTE:** \_\_\_\_\_

Chain and lubricant should be at room temperature to assure penetration of lubricant into rollers.

- c. Periodically, remove the chain, wipe and/or brush excess dirt off. Blow off with high pressure air.
- d. Soak chain in solvent, brushing off remaining dirt. Dry with high pressure air. Lubricate thoroughly while off machine. Work each roller thoroughly to make sure lubricant penetrates. Wipe off excess. Re-install.



## CHASSIS MAINTENANCE AND MINOR REPAIR

### Front wheel removal

1. Elevate the front wheel by placing a suitable stand under the engine.
2. To remove the front wheel, disconnect the brake cable at the front brake lever. Then remove cable from cam lever at front brake shoe plate.
3. Remove cotter pin from front wheel axle and remove axle nut.
4. Turn and pull out the front wheel axle; the wheel assembly can now be removed.

### Front wheel installation

When installing the front wheel, reverse the removal procedure noting the following:

1. Check for proper engagement of the boss on the outer fork tube with the locating slot on the brake shoe plate.

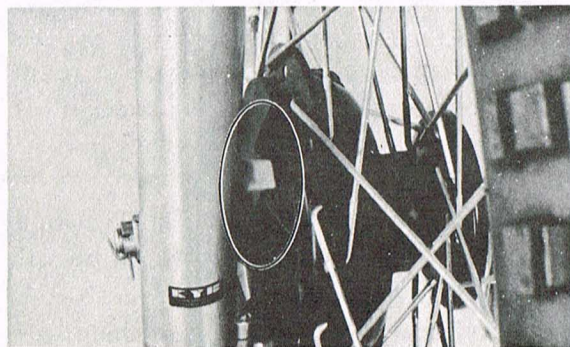

2. Always secure the front wheel axle as follows:
  - a. Torque the front axle nut.

Lee Waldie Craig Scott Chris Koira

Axle nut torque:  
9.0 m·kg (65 ft·lb)

- b. Install a new cotter pin; discard old pin.
- c. Adjust the play in the brake lever.

### Rear wheel removal

1. Elevate the rear wheel by placing a suitable stand under the engine.
2. Remove the brake rod from the cam lever by compressing the rod's spring seat. Then hold up the brake rod and place it on the hook of the rear arm.

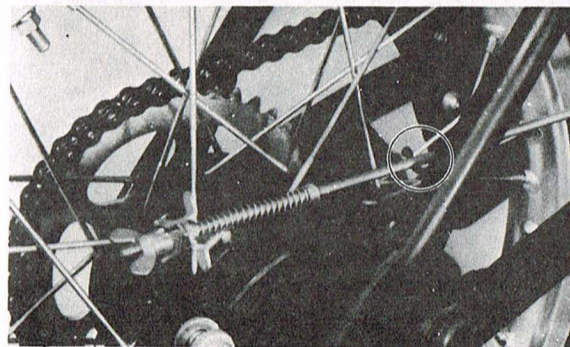

3. Remove the cotter pin from the axle nut and loosen the axle nut.

4. Remove the link clip and master link and remove the chain.
5. Remove the cotter pins (left and right) from clevis pins. Then remove the clevis pins.

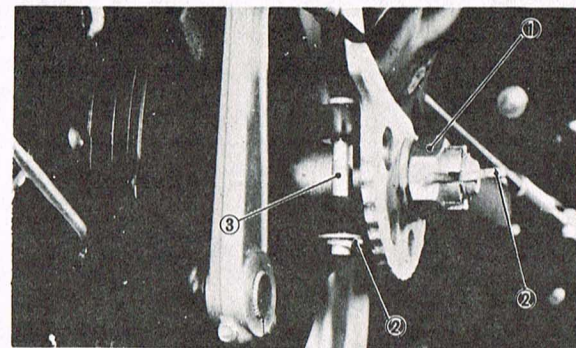

1. Axle nut
2. Cotter pin
3. Clevis pin

6. Pull the wheel backward, remove the rear wheel assembly.



### Rear wheel installation

The rear wheel can be reassembled by reversing the disassembly procedure. Take care of the following points.

1. When connecting the chain, make certain closed end of master link clip is facing direction of rotation.

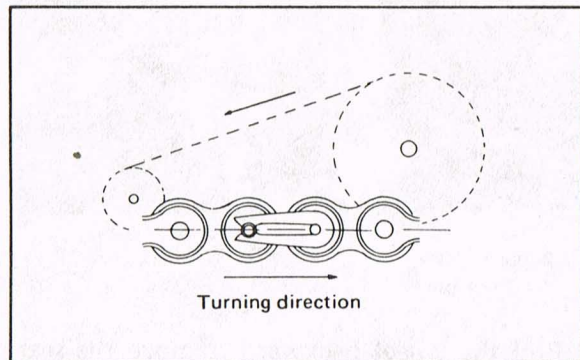

2. Check for proper engagement of the boss on swing arm with the locating slot on brake shoe plate.

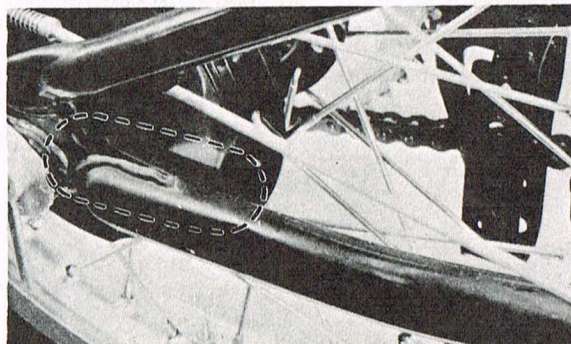

3. Make sure the nut is properly torqued.

Tightening torque: 10.0 m·kg (72 ft·lb)

4. Make sure to adjust the chain tension. See page 28 "Drive chain adjustment".
5. Adjust the play in the brake pedal.
6. Always use new cotter pins.

### Brake shoe inspection

Measure the outside diameter of the brake shoe set with slide calipers.

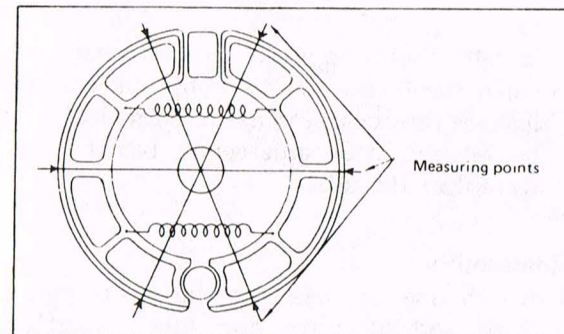

If it measures less than replacement limit replace the shoes. Smooth out any rough spots on shoe surface with sandpaper.

Brake shoe diameter	130 mm (5.12 in)
Replacement limit	126 mm (4.96 in)
minimum lining thickness	2 mm (0.079 in)

### Brake drum inspection

The friction between the inner surface of the brake drum and the brake lining provides the energy to stop the motorcycle. If these become damaged or if oil contacts the drum, noise may occur and brake performance will suffer. Check the inner surface of the brake drum and remove any scratches with emery cloth. Remove any oil with a cloth dipped in solvent. If damage is more extensive, have a Yamaha dealer replace the wheel hub.



### Tire removal and tire repair

1. Remove the wheel from the motorcycle.
2. Remove locknut from valve stem and release as much air as possible from the tire.
3. Push both tire beads away from the edges of the rim.
4. Starting opposite the valve stem on one side, use two round-ended tire irons to work the bead off the rim.

**NOTE:** \_\_\_\_\_  
Use tire removal lubricant and be careful not to pinch the tube with the tire irons.

5. Remove the valve stem from its hole and remove the tube.
6. If the tire is to be changed, remove the second bead from the rim using the tire irons and tire lubricant.

### Inspection

1. Use a cloth to check for nails or other sharp objects in the tire.

**WARNING:** \_\_\_\_\_  
**Always use a cloth to avoid cutting your hand.**

2. Check for faults in the side wall. If there is any fault, the tire should be replaced as a damaged tire may burst at high speeds, which is obviously extremely dangerous.
3. Inflate the tube with air and check the valve stem and the tube for damage and leakage replace as required. Some leaks can be patched in an emergency, but it is best to replace the tube.

### Reassembly

1. Install one tire bead on the rim using tire irons and lubricant and then install the tube.
2. Inflate tube with air to about one-third the specified pressure. Hit the outer circumference of the tire with a soft hammer to make certain the tube is not caught between tire and rim. Release air from tube.
3. Inspect rim band and replace if damaged.

4. Install second tire bead starting opposite the valve stem using tire irons and tire mounting lubricant.
5. Inflate tire to approximately 2.0 kg/cm<sup>2</sup> (30 psi) and then reduce pressure to specified setting.

**NOTE:** \_\_\_\_\_  
Check the valve stem; it must be pointing directly at center of wheel hub. If angled in any direction, release air and adjust tube position.

### Tire air pressure

Improper tire pressure affects the smoothness of the tire, traction, handling and the life of the tires. Always maintain the correct tire pressure.

Tire pressure for normal riding:  
Front ..... 1.0 kg/cm<sup>2</sup> (14 psi)  
Rear ..... 1.2 kg/cm<sup>2</sup> (17 psi)

### Rim and spokes

There are checks that you can perform to determine if wheel work is necessary for your dealer to do. First, check for any loose spokes. This can be checked by bracing the front end off the ground so that the front wheel can spin free. Slowly revolve the front wheel and at the same time let the metal shaft of a fairly heavy screwdriver bounce off each spoke. If all the spokes are tightened approximately the same, then the sound given off by the screwdriver hitting the spokes should sound the same. If one spoke makes a dull flat sound, then check it for looseness. While you have the front end up in the air, you should check that the front wheel does not have too much run-out. "Run-out" is the amount of the front wheel deviates from a straight line as it spins. Secure the front forks from turning, spin the front wheel, and solidly anchor some sort of a



pointer about 3 mm away from the side of the rim.

As the wheel spins, the distance between the pointer and the rim should not change more than 2 mm total. Any greater fluctuation means that you should have your dealer remove this rim warpage by properly adjusting the spokes.

### Replacing Wheel Bearings.

If the bearings allow excessive play in the wheel or if it does not turn smoothly, replace the bearings as follows:

1. First clean the outside of the wheel hub.
2. Insert the bent end of the special tool into the hole located in the center of the bearing spacer, and drive the spacer out of the hub. (Both bearing spacer and space flange can easily be removed.)

3. Push out the bearing on the other side.

4. To install the wheel bearing, reverse the above sequence. Be sure to grease the bearing before installation and use the bearing fitting tool.

5. Check the lips of the seals for damage or warpage. Replace if necessary.

### Steering inspection

Periodically inspect the condition of the steering. Worn out or loose steering bearings may be dangerous.

Place a block under the engine to raise the front wheel of the motorcycle off the ground; then hold the lower end of the front fork and try to move forward and backward.

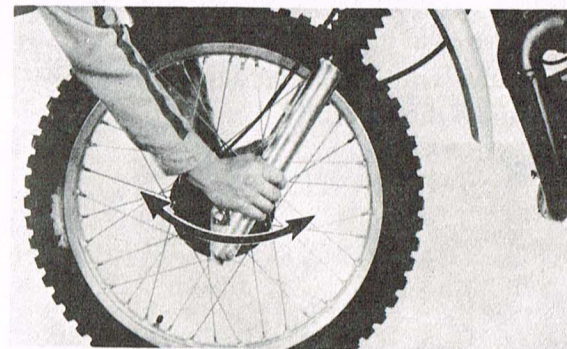

### Steering adjustment

1. To adjust, first loosen upper pinch bolts. Then loosen stem pinch bolt and stem bolt.
2. Use ring nut wrench to tighten ring nut.

#### CAUTION:

Forks must swing from lock to lock without binding or catching.

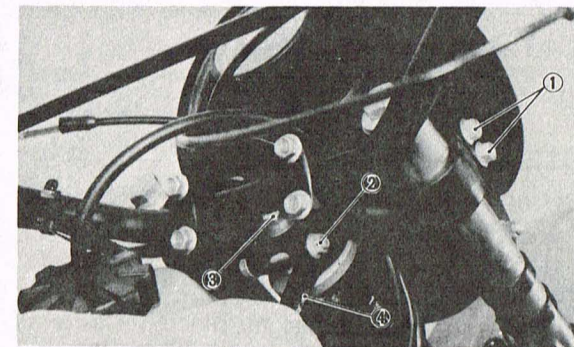

1. Pinch bolt
2. Stem pinch bolt
3. Stem bolt
4. Ring nut wrench

3. Tighten stem bolt and stem pinch bolt.

#### Tightening torque:

Stem bolt .....	6.0 m-kg (43 ft-lb)
Pinch bolt.....	1.5 m-kg (11 ft-lb)

4. Tighten pinch bolt.



Tightening torque:  
1.5 m-kg (11 ft-lb)

**NOTE:** \_\_\_\_\_  
Steering head disassembly must be performed by your Yamaha dealer.

#### Front fork oil change

1. Elevate front wheel by placing a suitable stand under the engine.
2. Remove cap bolts from inner fork tubes.

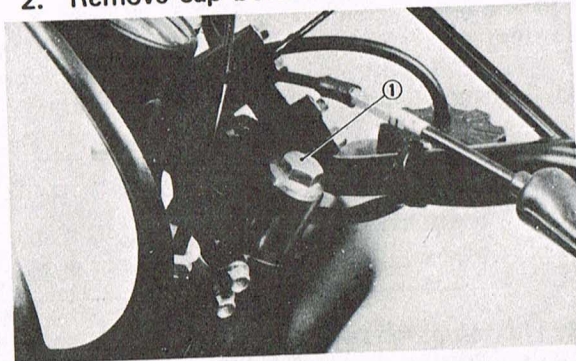

1. Cap bolt

3. Remove drain screw from each outer tube with open container under each drain hole.

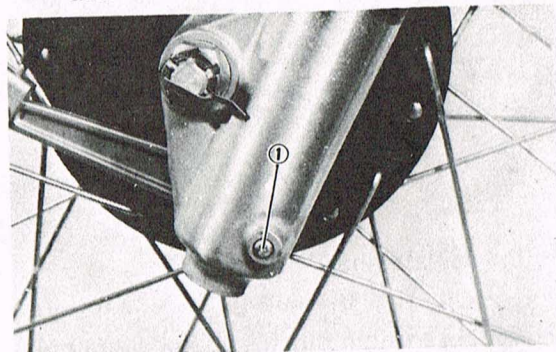

1. Drain screw

4. After most of oil has drained, slowly raise and lower outer tubes to pump out remaining oil.
5. Replace drain screw.

**NOTE:** \_\_\_\_\_  
Check gasket, replace if damaged.

6. Measure correct amount of oil and pour into each leg.

Recommended oil:  
Yamaha Fork Oil # 20

Quantity per leg:  
262 cc (8.86 oz)

**NOTE:** \_\_\_\_\_  
Select the weight oil that suits local conditions and your preference (lighter for less damping; heavier for more damping).

7. After filling, slowly pump the outer tubes up and down to distribute the oil.
8. Inspect "O" ring on cap bolts and replace if damaged.

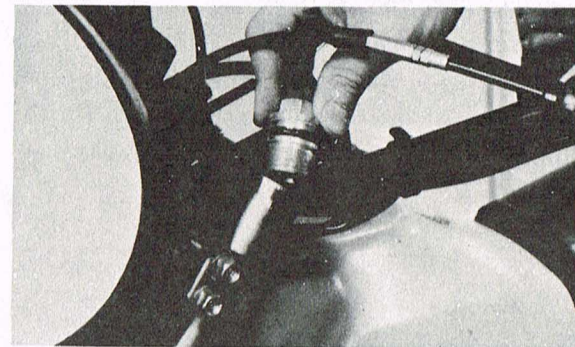

9. Install the cap bolts and torque to specification.

Tightening torque:  
2.5 m-kg (18.1 ft-lb)



### Front fork spring replacement

In addition to the standard type, two different type front fork springs are sold. A proper type should be selected according to the conditions of a racing course or the weight of the rider.

Type	Part No.	Spring rate (kg/mm)	I.D. mark*
Soft	Spring 1W2-23141-10	k1= 0.338, k2= 0.309	
	Spacer 1W2-23118-10	-	-
Standard	Spring 1W2-23141-00	k1= 0.326, k2= 0.442	
	Spacer -	-	-
Hard	Spring 1W2-23141-20	k1= 0.423, k2= 0.575	
	Spacer 1W2-23118-10	-	-

\*I.D. marking can be found scored on the top of the spring end.

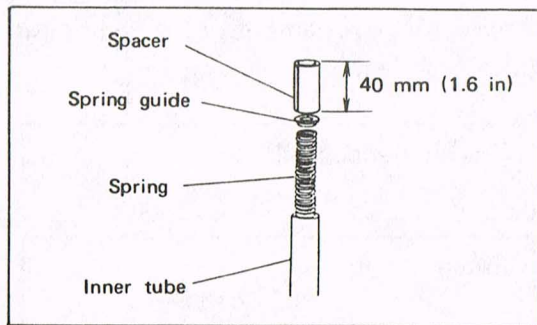

### REAR SHOCK (MONOCROSS SUSPENSION "DE CARBON" SYSTEM) AND SWING ARM Rear shock absorber

#### WARNING:

This shock absorber contains highly compressed nitrogen gas.

Read and understand the following information before handling the shock absorber. The manufacturer can not be held responsible for property damage or personal injury that may result from improper handling.

1. Do not tamper or attempt to open the cylinder assembly.
2. Do not subject shock absorber to an open frame or other high heat.
3. Do not deform or damage the cylinder in any way. Cylinder damage will result in poor damping performance.
4. Handle it with great care, for a score or scratch in the piston rod sliding portion will cause oil leakage.
5. Never remove the plug on the cylinder bottom. Injury may result.

#### Notes on Disposal (Yamaha dealers only)

Gas pressure must be released before disposing of shock absorber. To do so, drill a 2-3 mm (1/16 ~ 1/8 in) hole through the cylinder wall at a point 10-15 mm (2/5 ~ 3/5 in) above the bottom of the cylinder. At this time, wear eye protection to prevent eye damage from, escaping gas and/or metal chips.

#### WARNING:

To dispose of a damaged or worn-out shock absorber, take the unit to your Yamaha dealer for this disposal procedure.

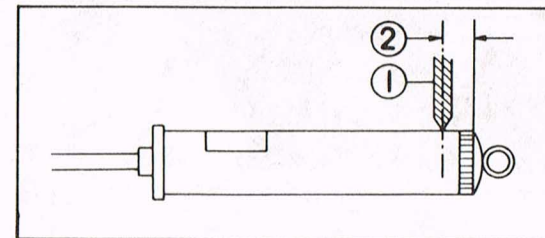

1. Drill 2 ~ 3 mm  $\phi$  (1/16 ~ 1/8 in)
2. 10 ~ 15 mm (2/5 ~ 3/5 in)

#### Adjustment

1. Damping performance

Adjustment can be made without removing the shock absorber.

Turn the adjuster with a slotted-head screwdriver through the hole provided one each on either side of the frame.



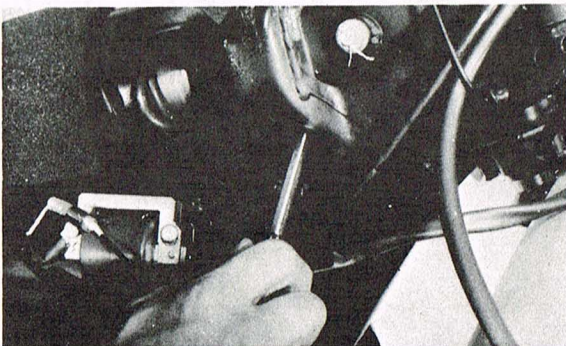

**NOTE:** \_\_\_\_\_  
 Turn the adjuster until it clicks. Maximum extent can be known by the position where turning suddenly feels heavy. Do not give any farther turns. The adjustable range covers approximately 8 notches from the standard position.

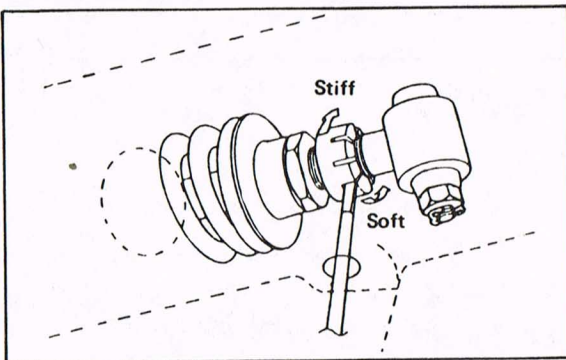

a. To make it stiffer, screw IN the adjuster.

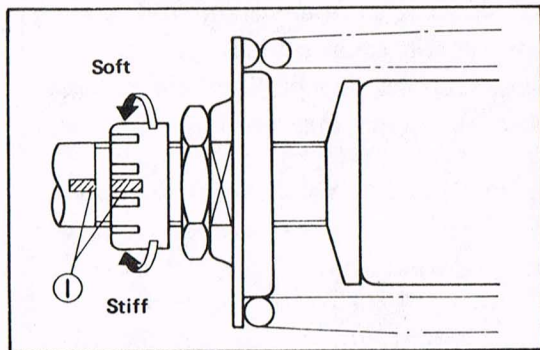

1. Alignment mark  
 (Yellow paint)

b. To make it softer, screw OUT the adjuster.

**NOTE:** \_\_\_\_\_  
 Turn the nut until it clicks. Minimum extent can be known by the position where turning suddenly feels light. Do not give any farther turns. The adjustable range covers approximately 12 notches from the standard position.

2. Changing suspension spring pre-load  
 Perform this adjustment with a special wrench (in the owner's tool kit).

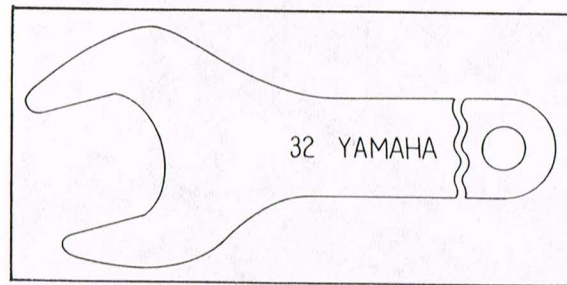

- a. Remove the shock absorber (See "removal" section).
- b. Loosen the adjuster lock nut.
- c. To increase fitting pre-load, screw IN the adjuster.  
 To decrease fitting pre-load, screw OUT the adjuster.
- d. Tighten the lock nut by retaining the adjuster at turning position.

Tightening torque:  
 6.0 m·kg (43.4 ft·lb)

**NOTE:** \_\_\_\_\_  
 Initial fitting length is set for 262 mm (10.3 in). Adjustable extent is maximum 271.5 mm (10.7 in) and minimum 256.5 mm (10.1 in). Be sure to adjust within the above limits.



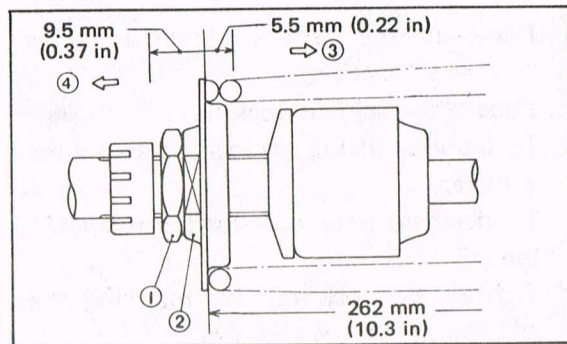

1. Lock nut 2. Adjuster 3. Increase pre-load 4. Decrease pre-load

### 3. Gas pressure

The gas pressure can be adjusted. For this adjustment, take the unit to your Authorized Yamaha Dealer.

### Removal

1. Remove the two bolt holding the fuel tank (petcock lever must be placed in OFF). Lift up the front of the tank and remove it.
2. Remove the cotter pin and nut. And remove the bolt securing the upper bracket to frame.

Upper bracket tightening torque:  
2.5 m·kg (18.1 ft·lb)

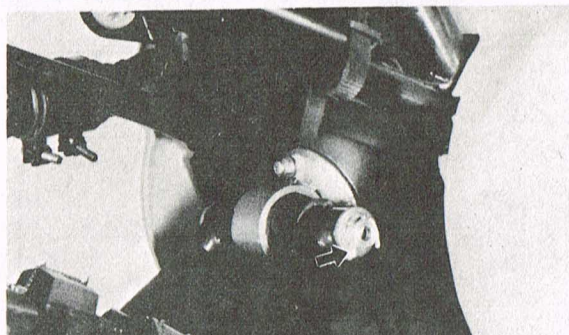
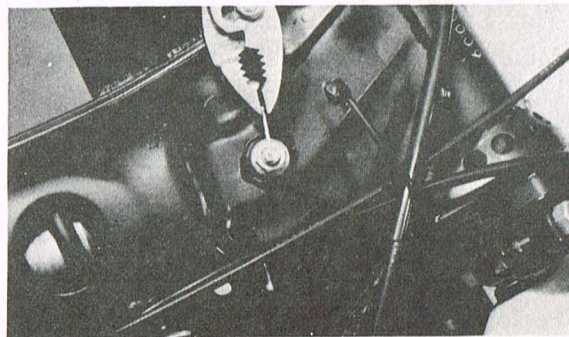

3. Remove the cotter pin and pull out the pivot shaft from the lower bracket.

### NOTE:

Always use a new cotter pin.

4. Remove the rear shock absorber from the frame. (To remove, pull the rear shock backward while lifting up the frame.)

### NOTE:

- a. When remove the shock absorber, be careful not to bend the absorber rod.
- b. Take care so the two washers are not lost.

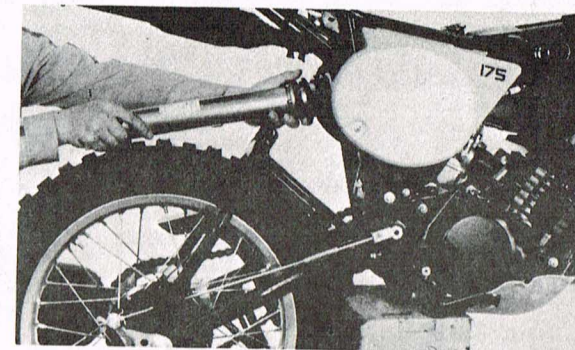

### Rear shock spring "B" replacement

In addition to the standard type, two different type rear shock springs "B" are sold. A proper type should be selected according to the conditions of a racing course or the weight of the rider.



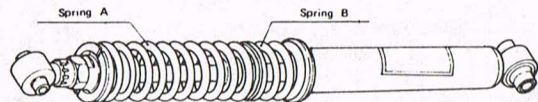

Type	Part No.	Spring rate (kg/mm)	Color code
Soft	90501-80483	$k_1 = 2.78$ , $k_2 = 5.20$	Yellow
Standard	90501-85470	$k_1 = 3.06$ , $k_2 = 5.20$	Blue
Hard	90501-90482	$k_1 = 3.31$ , $k_2 = 5.20$	Red

**NOTE:** \_\_\_\_\_

1. Code color is shown on the end of the spring.
2. The spring rate specified above is based on the combination of springs A and B.

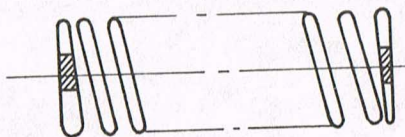

**Swing arm inspection**

1. With rear wheel and shock absorbers removed, grasp the ends of the arm and move from right to left to check for free play.

Swing arm free play:  
0 ~ 1 mm (0 ~ 0.039 in)

2. If free play is excessive, remove swing arm and replace swing arm bushings.

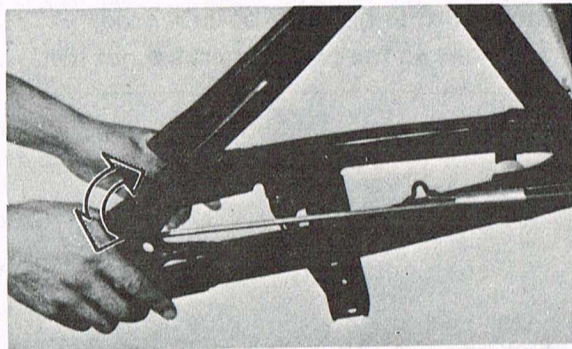

## ELECTRICAL

**General information**

The IT175E uses a flywheel magneto to generate electrical current/voltage for the lighting system and uses CDI system for ignition. There are two coils attached to the magneto backing plate. The righthand coil supplies primary voltage to the ignition coil. The lefthand coil provides alternating current (AC) for operation of the lights.

**NOTE:** \_\_\_\_\_

If headlight filament burns out while engine is running, the tail lamp filament may also burn out because of excess voltage. Always check taillight operation when replacing headlight.



## CIRCUIT DIAGRAM

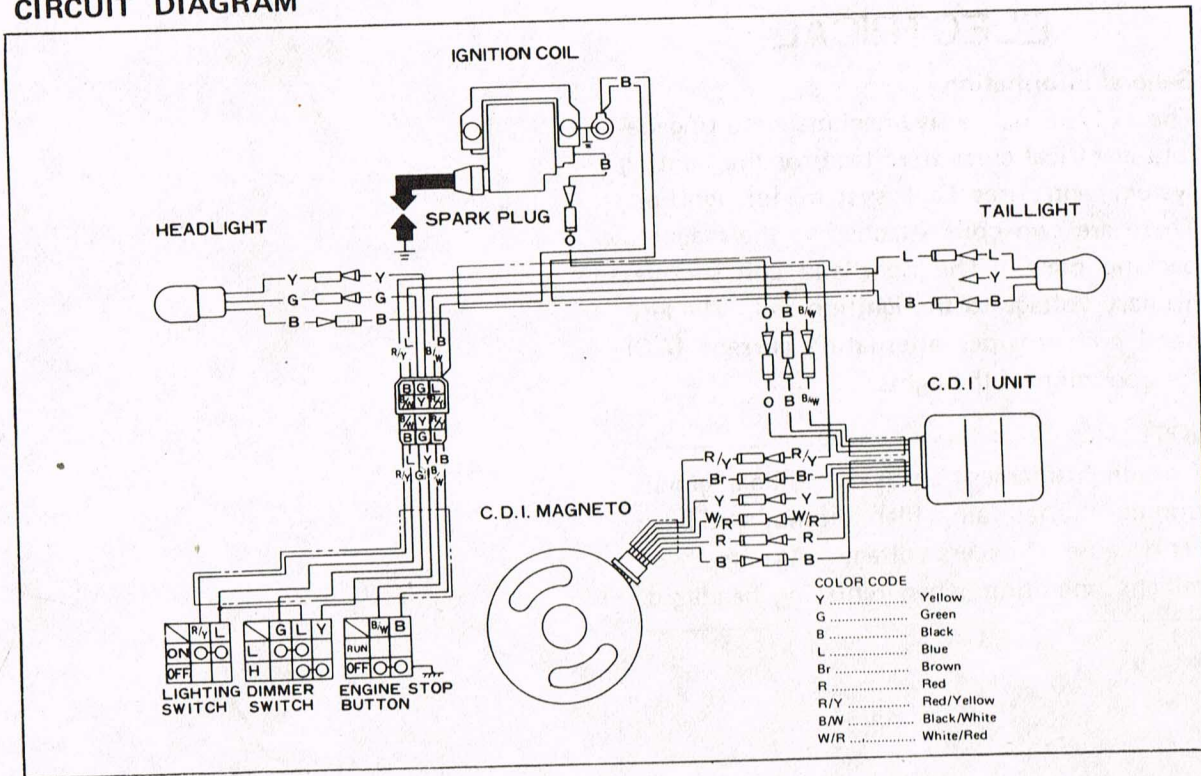

## Troubleshooting – Ignition

### 1. No spark is produced or weak.

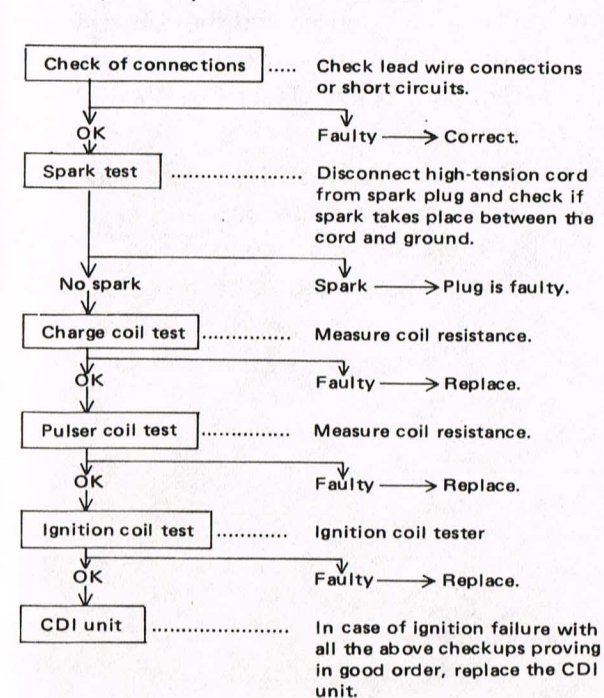

### 2. The engine starts but will not pick up speed.

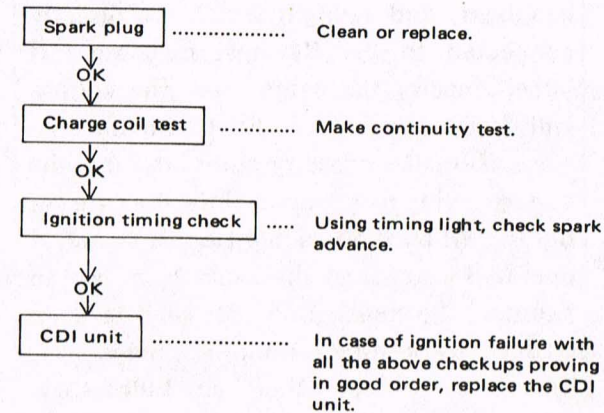

## Lighting systems

### 1. Description

The lighting system consists of the lighting coil, headlight and taillight. Lighting coil in the flywheel magneto supplies alternating current (A.C.) for the headlight, and tail-light.



**WARNING:**

Use bulbs of the correct capacity for the headlight, and taillight which are directly connected to the flywheel magneto. If large capacity bulbs are used, the voltage will drop, giving a poor light. On the contrary, if smaller capacity bulbs are used, the voltage will rise, shortening the life of bulbs. When the headlight beam switch is operated to change the beam from one to another, the headlight is designed to keep both bulbs burning during the change over. This is to protect other light bulbs from burning out as a result of turning off the head light, even temporarily. If one of these light bulbs is burnt out while the machine is running, it will overload other bulbs and shorten their service life. Reduce engine speed and replace a burnt bulb as quickly as possible.

**2. A.C. Circuit output test**

With all A.C. light in operation the circuit will be balanced and the voltage will be the same at all points at a given r.p.m.

- a. Switch Pocket Tester to "AC20V" position. Lee Waldie Craig Scott Chris Koirra
- b. Connect positive (+) test lead to Red/Yellow connection and negative (-) test lead to a ground.
- c. Connect Engine speed tachometer.
- d. Start engine, turn on light switch and check voltage at each engine speed in table below.

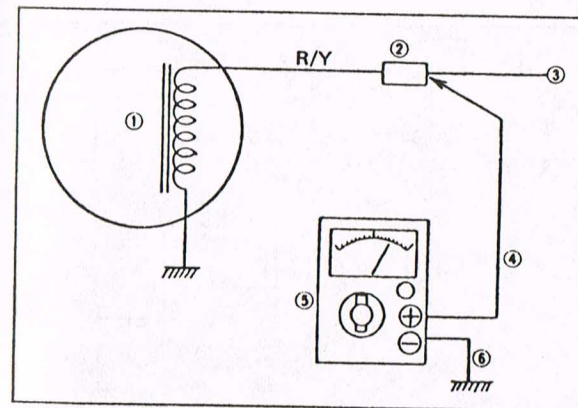

- |                                 |                                                       |
|---------------------------------|-------------------------------------------------------|
| 1. Lighting coil                | 5. Pocket tester (Set the tester in A.C.20V position) |
| 2. Connector                    | 6. Negative lead wire                                 |
| 3. To head light and tail light |                                                       |
| 4. Positive lead wire of tester | R/Y: Red/Yellow                                       |

If measured voltage is too high or too low, check for bad connections, damaged wires, burned out bulbs or bulb capacities are too large throughout the A.C. lighting circuit.

**Output Voltage:**

5.0V or more/2,500 r/min  
7.0V or less/8,000 r/min

**NOTE:**

Be sure to turn the lighting switch to ON.

**NOTE:**

This voltage test can be made at any point throughout the A.C. lighting circuit and the readings should be the same as specified above.



### 3. Lighting coil resistance check

If voltage is incorrect in the A.C. lighting circuit, check the resistance of the yellow-red wire windings of the lighting coil.

- a. Switch pocket Tester to " $\Omega \times 1$ " position and zero meter.
- b. Connect positive (+) test lead to yellow and red-yellow wire from magneto and negative (-) test lead to a good ground on engine. Read the resistance on ohms scale.

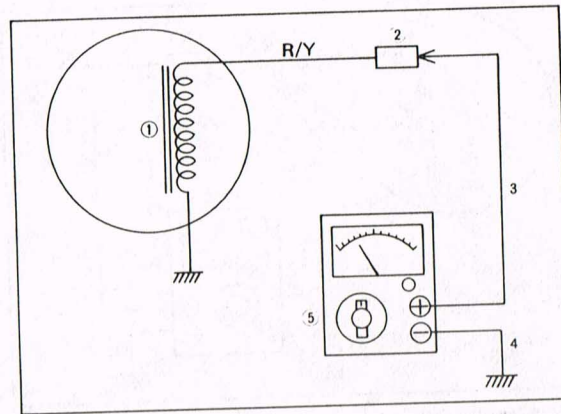

1. Lighting coil
2. Connector
3. Positive lead wire of tester
4. Negative lead wire
5. Pocket tester (Set the tester "Resistance" position)

R/Y: Red/Yellow

Lighting coil  
resistance:  
 $0.45\Omega \pm 10\% (20^\circ\text{C})$

### Troubleshooting

Although Yamaha motorcycles are given a rigid inspection before shipment from the factory, trouble may occur in operation. If this happens check the motorcycle in accordance with the procedures given in the troubleshooting chart below. If repair is necessary, ask your Yamaha dealer.

The skilled technicians at your Yamaha dealer provide excellent service. For replacement parts, use only genuine Yamaha parts. Imitation parts are similar in shape but often inferior in quality of materials and workmanship; consequently, service life is shorter and more expensive repairs may be necessitated.

Any fault in the fuel, compression or ignition system can cause poor starting or loss of power while riding. The troubleshooting chart describes quick and easy procedures for checking these systems.



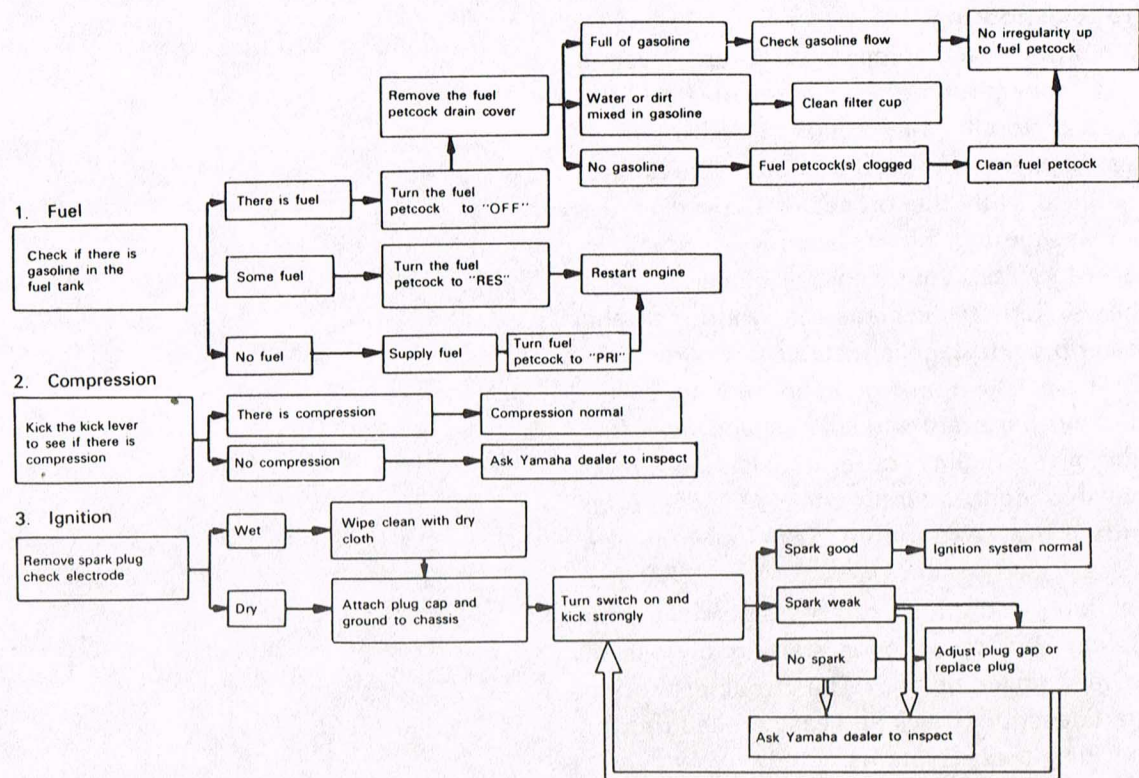

## CLEANING AND STORAGE

### A. CLEANING

Frequent thorough cleaning of your motorcycle will not only enhance its appearance but will improve general performance and extend the useful life of many components.

1. Before cleaning the machine:
  - a. Block off end of exhaust pipe to prevent water entry; a plastic bag and strong rubber band may be used.
  - b. Remove air cleaner or protect it from water with plastic covering.
  - c. Make sure spark plug(s), fuel tank cap, oil tank cap, transmission oil filler cap are properly installed.
2. If engine case is excessively greasy, apply degreaser with a paint brush. Do not apply degreaser to chain, sprockets, or wheel axles.
3. Rinse dirt and degreaser off with garden hose, using only enough hose pressure to do the job. Excessive hose pressure may cause water seepage and contamination of wheel bearings, front forks, brake drums, and transmission seals. Many expensive repair bills have resulted from improper high pressure detergent applications such as those available in coin-operated car washers.
4. Once the majority of the dirt has been hosed off, wash all surfaces with warm water and mild, detergent-type soap. An old tooth brush or bottle brush is handy to reach hard-to-get-to places.
5. Rinse machine off immediately with clean water and dry all surfaces with a chamois, clean towel, or soft absorbent cloth.
6. Immediately after washing, remove excess moisture from chain and lubricate to prevent rust.



7. Chrome-plated parts such as handlebars, rims, spokes, forks, etc., may be further cleaned with automotive chrome cleaner.
8. Clean the seat with a vinyl upholstery cleaner to keep the cover pliable and glossy.
9. Automotive-type wax may be applied to all painted and chrome-plated surfaces. Avoid combination cleaner-waxes. Many contain abrasives which may mar paint or protective finish on fuel and oil tanks.
10. After finishing, start the engine immediately and allow to idle for several minutes.

## B. STORAGE

Long term storage (30 days or more) of your motorcycle will require some preventive procedures to insure against deterioration. After cleaning machine thoroughly, prepare

for storage as follows:

1. Drain fuel tank, fuel lines, and carburetor float bowl(s).
2. Remove empty fuel tank, pour a cup of SAE 10W/30 oil in tank, shake tank to coat inner surfaces thoroughly and drain off excess oil. Re-install tank.
3. Remove spark plug(s), pour about one tablespoon of SAE 10W/30 oil in spark plug hole(s) and re-install spark plugs. Kick engine over several times (with ignition off) to coat cylinder walls with oil.
4. Remove drive chain. Clean thoroughly with solvent and lubricate. Re-install chain or store in a plastic bag (tie to frame for safe-keeping).
5. Lubricate all control cables.
6. Block up frame to raise both wheels off ground. (Main stands can be used on machine.)
7. Tie a plastic bag over exhaust pipe outlet(s) to prevent moisture from entering.

8. If storing in humid or salt-air atmosphere, coat all exposed metal surfaces with a light film of oil. Do not apply oil to rubber parts or seat cover.

Remove battery and charge. Store in a dry place and re-charge once a month. Do not store battery in an excessively warm or cold place less than 0°C (32°F) or more than 32°C (90°F).

**NOTE:** \_\_\_\_\_  
Make any necessary repairs before storing the motorcycle.  
\_\_\_\_\_



## MISCELLANEOUS

### A. General

Dimension:	
Overall length	2,160 mm (85 in)
Overall width (Standard)	900 mm (35.4 in)
Overall height (Standard)	1,140 mm (44.9 in)
Seat height	860 mm (33.9 in)
Wheelbase	1,385 mm (54.5 in)
Minimum ground clearance	240 mm (9.4 in)
Weight:	
Net weight	98 kg (216 lb)

### B. Engine

Description:	
Engine type	Air cooled, 2-stroke gasoline, Torque induction
Engine model	1W2
Displacement	171 cc (10.4 cu.in)
Bore x stroke	66 x 50 mm (2.6 x 1.97 in)

Compression ratio	7.4 : 1
Starting system	Primary kick starter
Ignition system	C.D.I. ignition
Lubrication system	Mixed gas 20 : 1
Cylinder head:	
Combustion chamber volume	13.5 cc (0.82 cu.in)
Combustion chamber type	Dome + Squish
Head gasket thickness	0.5 mm
Cylinder:	
Material	Cast iron
Bore size	66 mm (2.6 in)
Taper limit	0.05 mm
Out of round limit	0.01 mm
Piston:	
Piston skirt clearance	0.040 ~ 0.045 mm
Piston over size	66.25, 66.50, 66.75, 67.00 mm
Piston pin outside Diameter x length	16 x 57 mm (0.63 x 2.24 in)
Piston rings:	
Piston ring design (Top) (2nd)	Keystone Plane (with expander)
Ring end gap (Installed)	0.3 ~ 0.5 mm
Ring groove side clearance	0.29 ~ 0.58 mm







<b>Carburetor:</b>		
Type, manufacture		VM34SS, Mikuni
I.D. mark		1W200
Main jet	(M.J.)	#360
Air jet	(A.J.)	2.5
Jet needle — Clip position (J.N.)		6F21-3
Needle jet	(N.J.)	P-4
Cutaway	(C.A.)	2.0
Pilot jet	(P.J.)	60
Air screw turns out	(A.S.)	1-1/2
Starter jet	(G.S.)	80
Float arm height	(F.H.)	23.5 mm (0.93 in)

### C. Chassis

<b>Frame:</b>	
Design	Tubular, Semi double cradle
<b>Steering system:</b>	
Caster	58°
Trail	144 mm (5.67 in)
Lock to lock angle	92°

<b>Front suspension:</b>	
Type	Telescopic fork
Damper type	Coil spring, oil damper
Front fork travel	195 mm (7.68 in)
Front fork spring-free length	566 mm (22.3 in)
— Wire dia. x winding dia.	4 x 26.5 mm (0.16 x 1.04 in)
— Spring constant	$k_1 = 0.326$ , $k_2 = 0.442$
Inner tube outside dia.	36 mm (1.42 in)
Oil seal type	SD36-48-10.5
Oil quantity	262 cc (16 cu.in) / Yamaha fork oil # 20
<b>Rear suspension:</b>	
Type	Monocross
Damper type	Coil spring, gas/oil damper
Gas pressure	18 kg/cm <sup>2</sup>
Gas properties	Nitrogen gas
Absorber stroke	107.5 mm (4.23 in)
Wheel travel	185 mm (7.28 in)
Compression spring	
— Free length	204.5 mm, 70 mm (8.05 in, 2.76 in)
— Set length	199.8 mm, 66.7 mm (7.87 in, 2.63 in)
— Spring constant	$k_1 = 5.20$ , $k_2 = 7.41$
— Number of windings	9                      4.75



– Spring diameter – Spring O.D. Swing arm free play	10 mm, 8.5 mm (0.4 in, 0.33 in) 75 mm, 72 mm (2.95 in, 2.83 in) 0 ~ 1 mm (0 ~ 0.04 in)
Fuel tank: Capacity Fuel grade	9.5 lit (2.51 US. gal) Regular or low lead gasoline
Wheel: Tire size (Front) (Rear) Tire pressure (Front) (Rear) Rim size (Front) (Rear) Rim run out limit (F, R) Vertical Lateral Secondary drive chain type Type Number of links Chain free play	3.00-21-4PR / Inoue 4.10-18-4PR / Inoue 1.0 kg/cm <sup>2</sup> (14 psi) 1.2 kg/cm <sup>2</sup> (17 psi) 1.60 x 21 1.85 x 18  2 mm (0.08 in) 2 mm (0.08 in)  DK520TR 93 40 ~ 50 mm (1.57 ~ 1.97 in)

Brake: Type Drum diameter Shoe dia. x width (F/R)  Lining thickness (Wear limit) Shoe spring free length	Leading, trailing 130 mm (5.12 in) 130 x 22 mm / 130 x 28 mm (5.12 x 0.87 in / 5.12 x 1.1 in) 2 mm (0.08 in) 35 mm (1.38 in)
----------------------------------------------------------------------------------------------------------------------------	---------------------------------------------------------------------------------------------------------------------------------------------

#### D. Electrical

Ignition system : Type Model/Manufacturer Voltage Source coil resistance Pulser coil resistance Flywheel puller thread size	CDI magneto F3T20071 (Mitsubishi) 6V 420 Ω 12.4 Ω 27 mm (1.06 in)
Ignition timing (B.T.D.C.):	-2.3 ± 0.15 mm (0.09 ± 0.006 in)
Ignition coil: Model/Manufacturer Spark gap Primary winding resistance Secondary winding resistance Diode	F6T41174 / Mitsubishi 6 mm (0.24 in) 1.0 Ω ± 15% 5.9K Ω ± 20% No



Spark plug: Type / Manufacturer Spark plug gap	N-2G / Champion 0.7 mm (0.028 in)
CDI unit: Type/Manufacturer	F8T00671 / Mitsubishi
Charging system: Flywheel magneto Lighting coil resistance (Y/R) • Lighting output	F3T20071 0.45Ω ± 10% 5V or more / 2,500 r/min 7V or less / 8,000 r/min
Lighting system: Headlight type Headlight wattage Taillight wattage	Bulb type 6V, 25W/25W 6V, 5.3W

### E. Tightening torque

Engine:			
Cylinder head	M8	2.5 m-kg	(18 ft-lb)
Cylinder	M10	4.0 m-kg	(29 ft-lb)
Clutch boss	M14	5.0 m-kg	(36 ft-lb)
Primary drive gear	M12	7.0 m-kg	(50 ft-lb)

Drive sprocket	M16	6.0 m-kg	(43 ft-lb)
CDI rotor	M12	5.0 m-kg	(36 ft-lb)
Engine mounting bolt	M8	2.5 m-kg	(18 ft-lb)
Lee Waldie Craig Scott Chris Koira	M10	4.5 m-kg	(32 ft-lb)
<b>Chassis:</b>			
Handle crown — Handle holder	M8	1.5 m-kg	(11 ft-lb)
— Inner tube	M8	1.5 m-kg	(11 ft-lb)
— Steering shaft	M8	1.5 m-kg	(11 ft-lb)
Steering stem bolt	M14	6.0 m-kg	(43 ft-lb)
Under bracket — Inner tube	M8	2.5 m-kg	(18 ft-lb)
— Steering shaft	M10	2.0 m-kg	(14 ft-lb)
Front fork cap bolt	M32	2.0 m-kg	(14 ft-lb)
— Cylinder holding bolt	M10	2.5 m-kg	(18 ft-lb)
Front wheel axle	M14	10.0 m-kg	(70 ft-lb)
Pivot shaft	M16	9.0 m-kg	(65 ft-lb)
Rear wheel axle	M14	10.0 m-kg	(70 ft-lb)
Driven sprocket	M10	4.5 m-kg	(32 ft-lb)
Rear hub stud bolt	M10	4.0 m-kg	(29 ft-lb)
Rear suspension ass'y - Frame	M8	2.5 m-kg	(18 ft-lb)
— Adjuster lock nut	M32	6.0 m-kg	(43 ft-lb)



## INSTALLATION OF THE OFF-ROAD RIDING KIT

An off-road riding kit is provided with each vehicle to comply with noise level and spark arrester laws and regulations. Performance will be substantially decreased. Returning is not required.

### Description of the kit

Parts name	Q'ty
Silencer cap	1
Plate	1
Pan-head screw with washer	2
Cylinder head gasket	1
Ring nut	1
Main jet (#230)	1

### Installing the kit parts

#### 1. Silencer cap (Replace)

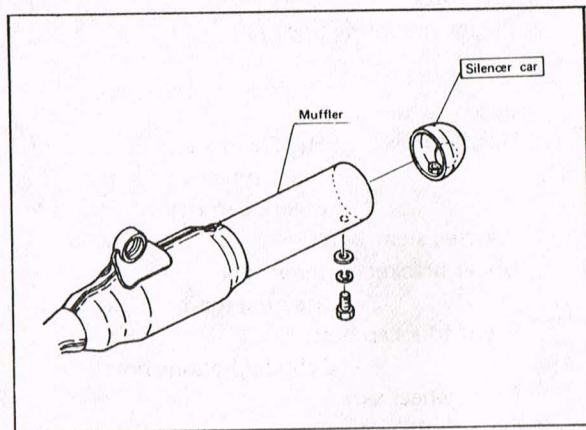

#### 2. Main jet

For main jet installation, refer to page 37.

#### 3. Plate (Addition)

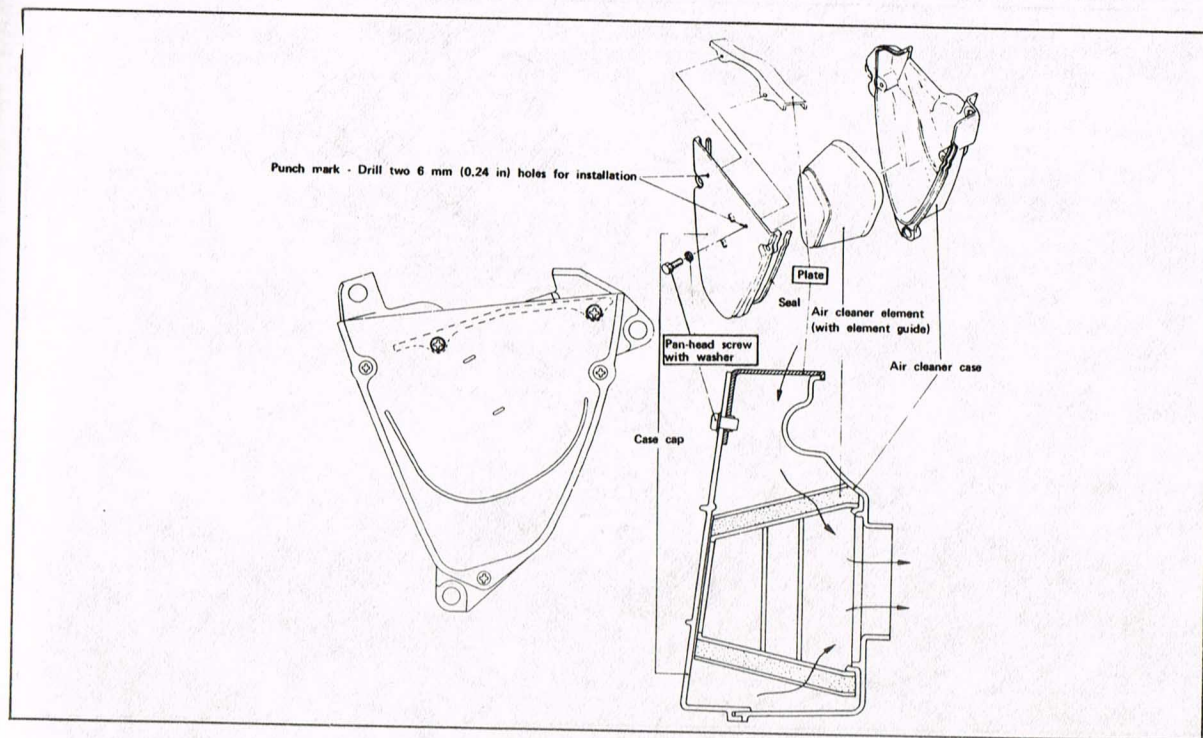



#### 4. Cylinder head gasket (Replace)

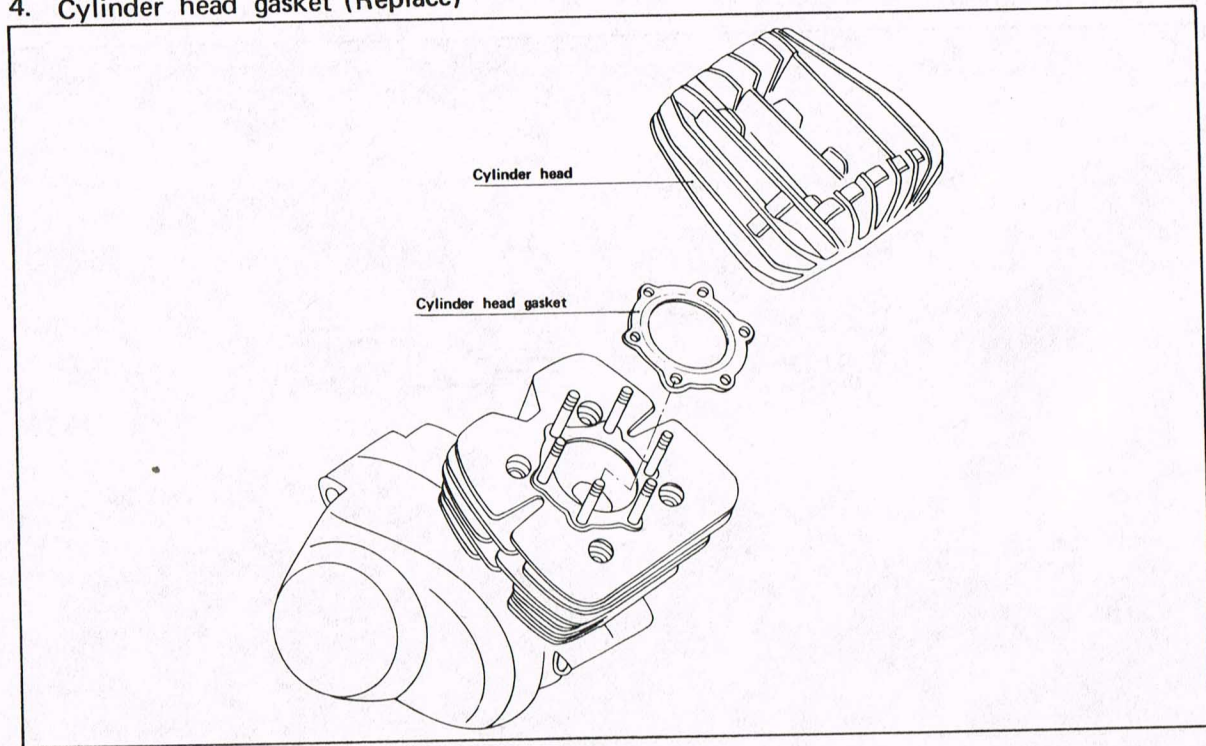

#### 5. Ring nut (Replace)

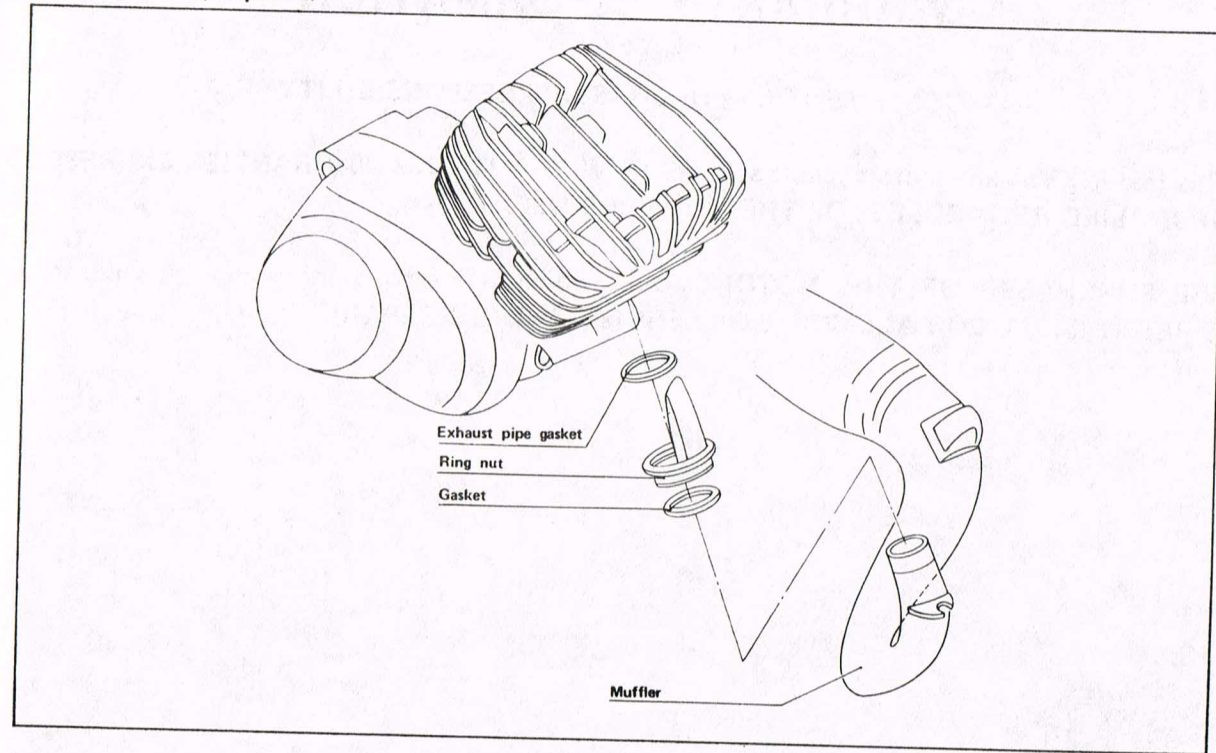



## **WARRANTY INFORMATION**

### **STATEMENT OF PURCHASER'S RESPONSIBILITY**

**This (model) Yamaha motorcycle is sold AS IS, WITHOUT ANY WARRANTIES EXPRESSED OR IMPLIED REGARDLESS OF THE INTENDED USE.**

**THE PURCHASER OF THIS MOTORCYCLE, which is intended for competition purposes, IS RESPONSIBLE FOR ALL COSTS OF SERVICE AND/OR REPAIR.**



